



FTOS Configuration Guide for the S4820T (FTOS 8.3.19.0) System

Publication Date: March 2013



Force10

Notes, Cautions, and Warnings

-  NOTE: A NOTE indicates important information that helps you make better use of your computer.
-  CAUTION: A CAUTION indicates either potential damage to hardware or loss of data and tells you how to avoid the problem.
-  WARNING: A WARNING indicates a potential for property damage, personal injury, or death.

Information in this publication is subject to change without notice.

© 2013 Dell Force10. All rights reserved.

Reproduction of these materials in any manner whatsoever without the written permission of Dell Inc. is strictly forbidden.

Trademarks used in this text: Dell™, the DELL logo, Dell Precision™, OptiPlex™, Latitude™, PowerEdge™, PowerVault™, PowerConnect™, OpenManage™, EqualLogic™, KACE™, FlexAddress™ and Vostro™ are trademarks of Dell Inc. Intel®, Pentium®, Xeon®, Core™ and Celeron® are registered trademarks of Intel Corporation in the U.S. and other countries. AMD® is a registered trademark and AMD Opteron™, AMD Phenom™, and AMD Sempron™ are trademarks of Advanced Micro Devices, Inc. Microsoft®, Windows®, Windows Server®, MS-DOS® and Windows Vista® are either trademarks or registered trademarks of Microsoft Corporation in the United States and/or other countries. Red Hat Enterprise Linux® and Enterprise Linux® are registered trademarks of Red Hat, Inc. in the United States and/or other countries. Novell® is a registered trademark and SUSE™ is a trademark of Novell Inc. in the United States and other countries. Oracle® is a registered trademark of Oracle Corporation and/or its affiliates. Citrix®, Xen®, XenServer® and XenMotion® are either registered trademarks or trademarks of Citrix Systems, Inc. in the United States and/or other countries. VMware®, Virtual SMP®, vMotion®, vCenter®, and vSphere® are registered trademarks or trademarks of VMWare, Inc. in the United States or other countries.

Other trademarks and trade names may be used in this publication to refer to either the entities claiming the marks and names or their products. Dell Inc. disclaims any proprietary interest in trademarks and trade names other than its own.

| | | |
|---|---|----|
| 1 | About this Guide | 29 |
| | Objectives | 29 |
| | Audience | 29 |
| | Conventions | 29 |
| | Information Symbols | 30 |
| | Related Documents | 30 |
| 2 | Configuration Fundamentals | 33 |
| | Accessing the Command Line | 33 |
| | CLI Modes | 34 |
| | Navigating CLI Modes | 35 |
| | The do Command | 37 |
| | Undoing Commands | 39 |
| | Obtaining Help | 39 |
| | Entering and Editing Commands | 40 |
| | Command History | 41 |
| | Filtering show Command Outputs | 41 |
| | Multiple Users in Configuration mode | 44 |
| 3 | Getting Started | 45 |
| | Console access | 45 |
| | Serial console | 45 |
| | Default Configuration | 47 |
| | Configure a Host Name | 47 |
| | Access the System Remotely | 47 |
| | Access the C-Series, E-Series, S4810, and the S4820T Remotely | 48 |
| | Access the S-Series Remotely | 49 |
| | Configure the Enable Password | 50 |
| | Configuration File Management | 51 |
| | Copy Files to and from the System | 51 |
| | Save the Running-configuration | 52 |
| | Configure the Overload bit for Startup Scenario | 53 |
| | View Files | 54 |
| | File System Management | 56 |
| | View command history | 57 |
| | Upgrading FTOS | 57 |
| 4 | Management | 59 |
| | Configure Privilege Levels | 59 |
| | Create a Custom Privilege Level | 59 |
| | Apply a Privilege Level to a Username | 62 |
| | Apply a Privilege Level to a Terminal Line | 62 |

| | |
|--|-----------|
| Configure Logging | 63 |
| Log Messages in the Internal Buffer | 63 |
| Configuration Task List for System Log Management | 63 |
| Disable System Logging | 63 |
| Send System Messages to a Syslog Server | 64 |
| Configure a Unix System as a Syslog Server | 64 |
| Change System Logging Settings | 64 |
| Display the Logging Buffer and the Logging Configuration | 65 |
| Configure a UNIX logging facility level | 66 |
| Synchronize log messages | 68 |
| Enable timestamp on syslog messages | 68 |
| File Transfer Services | 69 |
| Configuration Task List for File Transfer Services | 69 |
| Terminal Lines | 71 |
| Deny and Permit Access to a Terminal Line | 71 |
| Configure Login Authentication for Terminal Lines | 71 |
| Time out of EXEC Privilege Mode | 73 |
| Telnet to Another Network Device | 73 |
| Lock CONFIGURATION mode | 74 |
| Viewing the Configuration Lock Status | 75 |
| Recovering from a Forgotten Password on the S4810 or S4820T | 75 |
| Recovering from a Forgotten Enable Password on the S4810 or S4820T | 76 |
| Recovering from a Failed Start on the S4810 or S4820T | 76 |
| 5 802.1ag | 79 |
| Ethernet CFM | 79 |
| Maintenance Domains | 80 |
| Maintenance Points | 80 |
| Maintenance End Points | 81 |
| Implementation Information | 82 |
| Configure CFM | 82 |
| Related Configuration Tasks | 82 |
| Enable Ethernet CFM | 83 |
| Create a Maintenance Domain | 83 |
| Create a Maintenance Association | 84 |
| Create Maintenance Points | 84 |
| Create a Maintenance End Point | 84 |
| Create a Maintenance Intermediate Point | 85 |
| MP Databases | 85 |
| Continuity Check Messages | 86 |
| Enable CCM | 87 |
| Enable Cross-checking | 88 |
| Loopback Message and Response | 88 |

| | |
|--|------------|
| Linktrace Message and Response | 88 |
| Link Trace Cache | 89 |
| Enable CFM SNMP Traps. | 90 |
| Display Ethernet CFM Statistics | 91 |
| 6 802.1X | 93 |
| Protocol Overview | 93 |
| The Port-authentication Process | 94 |
| EAP over RADIUS | 95 |
| Configuring 802.1X | 97 |
| Related Configuration Tasks | 97 |
| Important Points to Remember | 97 |
| Enabling 802.1X | 97 |
| Configuring Request Identity Re-transmissions | 99 |
| Configuring a Quiet Period after a Failed Authentication | 100 |
| Forcibly Authorizing or Unauthorizing a Port | 101 |
| Re-authenticating a Port | 102 |
| Periodic Re-authentication | 102 |
| Configuring Timeouts | 103 |
| Dynamic VLAN Assignment with Port Authentication | 104 |
| Guest and Authentication-fail VLANs | 105 |
| Configuring a Guest VLAN | 106 |
| Configuring an Authentication-fail VLAN | 106 |
| 7 Access Control Lists (ACLs) | 109 |
| Overview | 109 |
| IP Access Control Lists (ACLs) | 110 |
| CAM Profiling, CAM Allocation, and CAM Optimization | 110 |
| Implementing ACLs on FTOS | 113 |
| IP Fragment Handling | 114 |
| Configure a standard IP ACL | 116 |
| Configure an extended IP ACL | 118 |
| Established Flag | 122 |
| Configuring Layer 2 and Layer 3 ACLs on an Interface | 122 |
| Assign an IP ACL to an Interface | 123 |
| Counting ACL Hits | 124 |
| Configuring Ingress ACLs | 125 |
| Configuring Egress ACLs | 125 |
| Egress Layer 3 ACL Lookup for Control-plane IP Traffic | 126 |
| Configuring ACLs to Loopback | 127 |
| Applying an ACL on Loopback Interfaces | 127 |
| IP Prefix Lists | 128 |
| Implementation Information | 129 |

| | |
|--|------------|
| Configuration Task List for Prefix Lists | 129 |
| ACL Resequencing | 133 |
| Resequencing an ACL or Prefix List | 134 |
| Route Maps | 136 |
| Implementation Information | 136 |
| Important Points to Remember | 136 |
| Configuration Task List for Route Maps | 136 |
| 8 Bidirectional Forwarding Detection (BFD)..... | 145 |
| Protocol Overview | 145 |
| How BFD Works | 146 |
| Important Points to Remember | 151 |
| Configuring Bidirectional Forwarding Detection | 151 |
| Configuring BFD for Physical Ports | 151 |
| Configuring BFD for Static Routes | 155 |
| Configuring BFD for OSPF | 157 |
| Configuring BFD for IS-IS | 160 |
| Configuring BFD for BGP | 163 |
| Configuring BFD for VRRP | 171 |
| Configuring BFD for VLANs | 174 |
| Configuring BFD for Port-Channels | 175 |
| Configuring Protocol Liveness | 177 |
| Troubleshooting BFD | 177 |
| 9 Border Gateway Protocol IPv4 (BGPv4)..... | 179 |
| Protocol Overview | 180 |
| Autonomous Systems (AS) | 180 |
| Sessions and Peers | 182 |
| Route Reflectors | 183 |
| Confederations | 184 |
| BGP Attributes | 185 |
| Best Path Selection Criteria | 185 |
| Weight | 188 |
| Local Preference | 188 |
| Multi-Exit Discriminators (MEDs) | 188 |
| Origin | 189 |
| AS Path | 190 |
| Next Hop | 190 |
| Multiprotocol BGP | 191 |
| Implementing BGP with FTOS | 191 |
| Additional Path (Add-Path) support | 191 |
| Advertise IGP cost as MED for redistributed routes | 191 |
| Ignore Router-ID for some best-path calculations | 192 |

| | |
|--|-----|
| 4-Byte AS Numbers | 192 |
| AS4 Number Representation | 193 |
| AS Number Migration | 195 |
| BGP4 Management Information Base (MIB) | 197 |
| Important Points to Remember | 197 |
| Configuration Information | 198 |
| BGP Configuration | 199 |
| Configuration Task List for BGP | 199 |
| MBGP Configuration | 238 |
| BGP Regular Expression Optimization | 239 |
| Debugging BGP | 239 |
| Storing Last and Bad PDUs | 240 |
| Capturing PDUs | 241 |
| PDU Counters | 243 |
| Sample Configurations | 243 |
| Example: Enable BGP, Router 1 | 244 |
| Example: Enable BGP, Router 2 | 245 |
| Example: Enable BGP, Router 3 | 246 |
| Example: Enable Peer Group, Router 1 | 247 |
| Example: Enable Peer Groups, Router 1 (Continued) | 248 |
| Example: Enable Peer Groups, Router 2 | 249 |
| Example: Enable Peer Groups, Router 3 | 250 |
| Example: Enable Peer Groups, Router 3 (Continued) | 251 |
| | |
| 10 Bare Metal Provisioning 2.0 | 253 |
| Prerequisites | 253 |
| Restrictions | 254 |
| Overview | 254 |
| Jumpstart mode | 255 |
| DHCP Server | 255 |
| File Server | 258 |
| Domain Name Server | 258 |
| Switch boot and set-up behavior in Jumpstart Mode | 258 |
| | |
| 11 Content Addressable Memory (CAM) | 261 |
| Content Addressable Memory | 261 |
| CAM Profiles | 262 |
| Microcode | 263 |
| CAM Profiling for ACLs | 264 |
| Boot Behavior | 265 |
| Example: EF Line Card with EG Chassis Profile (Card Problem) | 266 |
| Example: EH Line Card with EG Chassis Profile (Card Problem) | 266 |
| When to Use CAM Profiling | 267 |

| | |
|--|-----|
| Important Points to Remember | 267 |
| Differences Between EtherScale and TeraScale | 267 |
| Select CAM Profiles | 268 |
| CAM Allocation | 268 |
| Test CAM Usage | 269 |
| View CAM Profiles | 270 |
| View CAM-ACL settings | 271 |
| View CAM Usage | 272 |
| Configure IPv4Flow Sub-partitions | 273 |
| Configure Ingress Layer 2 ACL Sub-partitions | 276 |
| Return to the Default CAM Configuration | 278 |
| CAM Optimization | 278 |
| Applications for CAM Profiling | 278 |
| LAG Hashing | 278 |
| LAG Hashing based on Bidirectional Flow | 279 |
| CAM profile for the VLAN ACL group feature | 279 |
| Troubleshoot CAM Profiling | 279 |
| CAM Profile Mismatches | 279 |
| QoS CAM Region Limitation | 280 |
| | |
| 12 Control Plane Policing (CoPP) | 281 |
| Overview | 281 |
| Configure Control Plane Policing | 282 |
| Configure CoPP for protocols | 283 |
| Configure CoPP for CPU queues | 285 |
| Show commands | 286 |
| | |
| 13 Data Center Bridging (DCB) | 289 |
| Ethernet Enhancements in Data Center Bridging | 289 |
| Priority-Based Flow Control | 290 |
| Enhanced Transmission Selection | 292 |
| Data Center Bridging Exchange Protocol (DCBx) | 293 |
| Data Center Bridging in a Traffic Flow | 293 |
| Enabling Data Center Bridging | 294 |
| QoS dot1p Traffic Classification and Queue Assignment | 295 |
| Configuring Priority-Based Flow Control | 296 |
| Configuring Lossless Queues | 299 |
| Configuring the PFC Buffer in a Switch Stack | 300 |
| Configuring Enhanced Transmission Selection | 301 |
| ETS Prerequisites and Restrictions | 301 |
| Creating a QoS ETS Output Policy | 302 |
| Creating an ETS Priority Group | 305 |
| Applying an ETS Output Policy for a Priority Group to an Interface | 306 |

| | |
|--|-----|
| ETS Operation with DCBx | 307 |
| Configuring Bandwidth Allocation for DCBx CIN | 308 |
| Applying DCB Policies in a Switch Stack | 309 |
| Configuring DCBx Operation | 310 |
| DCBx Operation | 310 |
| DCBx Port Roles | 310 |
| DCB Configuration Exchange | 312 |
| Configuration Source Election | 312 |
| Propagation of DCB Information | 313 |
| Auto-Detection and Manual Configuration of the DCBx Version | 313 |
| DCBx Example | 314 |
| DCBx Prerequisites and Restrictions | 316 |
| DCBx Configuration Procedure | 316 |
| Verifying DCB Configuration | 321 |
| PFC and ETS Configuration Examples | 334 |
| Using PFC and ETS to Manage Data Center Traffic | 334 |
| Using PFC and ETS to Manage Converged Ethernet Traffic in a Switch Stack | 338 |
| Hierarchical Scheduling in ETS Output Policies | 339 |
| | |
| 14 Dynamic Host Configuration Protocol (DHCP) | 341 |
| Protocol Overview | 341 |
| DHCP Packet Format and Options | 342 |
| Assigning an IP Address using DHCP | 343 |
| Implementation Information | 344 |
| Configuration Tasks | 344 |
| Configure the System to be a DHCP Server | 344 |
| Configuration Tasks | 345 |
| Configure the Server for Automatic Address Allocation | 345 |
| Specify a Default Gateway | 347 |
| Enable DHCP Server | 347 |
| Configure a Method of Hostname Resolution | 348 |
| Create Manual Binding Entries | 348 |
| Debug DHCP server | 349 |
| DHCP Clear Commands | 349 |
| Configure the System to be a Relay Agent | 349 |
| Configure the System for User Port Stacking | 351 |
| Configure Secure DHCP | 351 |
| Option 82 | 351 |
| DHCP Snooping | 352 |
| Drop DHCP packets on snooped VLANs only | 354 |
| Dynamic ARP Inspection | 355 |
| Source Address Validation | 357 |

| | | |
|----|---|-----|
| 15 | Equal Cost Multi-Path (ECMP) | 361 |
| | ECMP for Flow-based Affinity | 361 |
| | Configurable Hash Algorithm | 361 |
| | Deterministic ECMP Next Hop | 362 |
| | Configurable Hash Algorithm Seed | 362 |
| | Link Bundle Monitoring | 363 |
| | Managing ECMP Group Paths | 364 |
| 16 | Enabling FIPS Cryptography | 365 |
| | Preparing the System | 365 |
| | Enabling FIPS Mode | 365 |
| | Generating Host-Keys | 366 |
| | Monitoring FIPS Mode Status | 367 |
| | Disabling the FIPS Mode | 367 |
| 17 | FIP Snooping | 369 |
| | Fibre Channel over Ethernet | 369 |
| | Ensuring Robustness in a Converged Ethernet Network | 369 |
| | FIP Snooping on Ethernet Bridges | 371 |
| | FIP Snooping in a Switch Stack | 373 |
| | Configuring FIP Snooping | 373 |
| | Enabling the FIP Snooping Feature | 374 |
| | Enabling FIP Snooping on VLANs | 374 |
| | Configuring the FC-MAP Value | 374 |
| | Configuring a Port for a Bridge-to-Bridge Link | 375 |
| | Configuring a Port for a Bridge-to-FCF Link | 375 |
| | Impact on Other Software Features | 375 |
| | FIP Snooping Prerequisites | 375 |
| | FIP Snooping Restrictions | 376 |
| | Configuration Procedure | 376 |
| | Displaying FIP Snooping Information | 377 |
| | FIP Snooping Configuration Example | 382 |
| 18 | Force10 Resilient Ring Protocol (FRRP) | 385 |
| | Protocol Overview | 385 |
| | Ring Status | 386 |
| | Multiple FRRP Rings | 387 |
| | Important FRRP Points | 387 |
| | Important FRRP Concepts | 388 |
| | Implementing FRRP | 389 |
| | FRRP Configuration | 390 |
| | Troubleshooting FRRP | 395 |

| | |
|--|-----|
| Configuration Checks | 395 |
| Sample Configuration and Topology | 395 |
| 19 GARP VLAN Registration Protocol (GVRP) | 397 |
| Protocol Overview | 397 |
| Important Points to Remember | 397 |
| Configuring GVRP | 398 |
| Related Configuration Tasks | 399 |
| Enabling GVRP Globally | 399 |
| Enabling GVRP on a Layer 2 Interface | 399 |
| Configuring GVRP Registration | 400 |
| Configuring a GARP Timer | 400 |
| 20 High Availability | 403 |
| Component Redundancy | 404 |
| RPM Redundancy | 404 |
| Online Insertion and Removal | 410 |
| RPM Online Insertion and Removal | 410 |
| Linecard Online Insertion and Removal | 411 |
| Hitless Behavior | 413 |
| Graceful Restart | 414 |
| Software Resiliency | 414 |
| Runtime System Health Check | 414 |
| SFM Channel Monitoring | 415 |
| Software Component Health Monitoring | 415 |
| System Health Monitoring | 415 |
| Failure and Event Logging | 415 |
| Hot-lock Behavior | 416 |
| Warm Upgrade | 417 |
| Configure Cache Boot | 418 |
| Process Restartability | 421 |
| 21 Internet Group Management Protocol (IGMP) | 423 |
| IGMP Implementation Information | 423 |
| IGMP Protocol Overview | 423 |
| IGMP version 2 | 423 |
| IGMP version 3 | 425 |
| Configuring IGMP | 428 |
| Related Configuration Tasks | 428 |
| Viewing IGMP Enabled Interfaces | 429 |
| Selecting an IGMP Version | 429 |
| Viewing IGMP Groups | 430 |

| | |
|--|------------|
| Adjusting Timers | 430 |
| Adjusting Query and Response Timers | 430 |
| Adjusting the IGMP Querier Timeout Value | 431 |
| Configuring a Static IGMP Group | 431 |
| Enabling IGMP Immediate-leave | 431 |
| IGMP Snooping | 432 |
| IGMP Snooping Implementation Information | 432 |
| Configuring IGMP Snooping | 432 |
| Enabling IGMP Immediate-leave | 433 |
| Disabling Multicast Flooding | 433 |
| Specifying a Port as Connected to a Multicast Router | 433 |
| Configuring the Switch as Querier | 433 |
| Fast Convergence after MSTP Topology Changes | 434 |
| Designating a Multicast Router Interface | 434 |
| 22 Interfaces | 435 |
| Interface Types | 436 |
| View Basic Interface Information | 436 |
| Enable a Physical Interface | 438 |
| Physical Interfaces | 439 |
| Configuration Task List for Physical Interfaces | 439 |
| Overview of Layer Modes | 439 |
| Configure Layer 2 (Data Link) Mode | 440 |
| Configure Layer 3 (Network) Mode | 441 |
| Management Interfaces | 442 |
| Management Interfaces on the E-Series, C-Series, S4810 and the S4820 | 442 |
| Configure Management Interfaces on the S-Series | 444 |
| VLAN Interfaces | 445 |
| Loopback Interfaces | 446 |
| Null Interfaces | 446 |
| Port Channel Interfaces | 446 |
| Bulk Configuration | 459 |
| Interface Range | 459 |
| Bulk Configuration Examples | 459 |
| Interface Range Macros | 461 |
| Define the Interface Range | 461 |
| Choose an Interface-range Macro | 461 |
| Monitor and Maintain Interfaces | 462 |
| Maintenance using TDR | 463 |
| Splitting QSFP ports to SFP+ ports | 464 |
| Important Points | 464 |
| Link Debounce Timer | 465 |
| Important Points to Remember about Link Debounce Timer | 465 |

| | |
|--|------------|
| Assign a debounce time to an interface | 466 |
| Show debounce times in an interface | 466 |
| Disable ports when one only SFM is available (E300 only) | 466 |
| Disable port on one SFM | 467 |
| Link Dampening | 467 |
| Important Points to Remember | 467 |
| Enable Link Dampening | 468 |
| Link Bundle Monitoring | 469 |
| Ethernet Pause Frames | 470 |
| Threshold Settings | 470 |
| Enable Pause Frames | 471 |
| Configure MTU Size on an Interface | 472 |
| Port-pipes | 473 |
| Auto-Negotiation on Ethernet Interfaces | 474 |
| View Advanced Interface Information | 477 |
| Display Only Configured Interfaces | 477 |
| Configure Interface Sampling Size | 478 |
| Dynamic Counters | 479 |
| Clear interface counters | 480 |
| 23 IPv4 Routing | 483 |
| IP Addresses | 483 |
| Implementation Information | 484 |
| Configuration Task List for IP Addresses | 484 |
| Directed Broadcast | 488 |
| Resolution of Host Names | 489 |
| ARP | 491 |
| Configuration Task List for ARP | 491 |
| ARP Learning via Gratuitous ARP | 493 |
| ARP Learning via ARP Request | 494 |
| Configurable ARP Retries | 495 |
| ICMP | 495 |
| Configuration Task List for ICMP | 495 |
| UDP Helper | 496 |
| Configuring UDP Helper | 496 |
| Important Points to Remember about UDP Helper | 497 |
| Enabling UDP Helper | 497 |
| Configuring a Broadcast Address | 498 |
| Configurations Using UDP Helper | 498 |
| UDP Helper with Broadcast-all Addresses | 498 |
| UDP Helper with Subnet Broadcast Addresses | 499 |
| UDP Helper with Configured Broadcast Addresses | 500 |
| UDP Helper with No Configured Broadcast Addresses | 500 |

| | |
|---|------------|
| Troubleshooting UDP Helper | 501 |
| 24 iSCSI Optimization | 503 |
| iSCSI Optimization Overview | 503 |
| Monitoring iSCSI Traffic Flows | 505 |
| Application of Quality of Service to iSCSI Traffic Flows | 505 |
| Information Monitored in iSCSI Traffic Flows | 505 |
| Detection and Auto-configuration for Dell EqualLogic Arrays | 506 |
| Detection and Port Configuration for Dell Compellent Arrays | 506 |
| Enabling and Disabling iSCSI Optimization | 507 |
| Default iSCSI Optimization Values | 508 |
| iSCSI Optimization Prerequisites | 508 |
| Configuring iSCSI Optimization | 508 |
| Displaying iSCSI Optimization Information | 510 |
| | |
| 25 Intermediate System to Intermediate System | 513 |
| Protocol Overview | 513 |
| IS-IS Addressing | 514 |
| Multi-Topology IS-IS | 515 |
| Transition Mode | 515 |
| Interface support | 516 |
| Adjacencies | 516 |
| Graceful Restart | 516 |
| Implementation Information | 517 |
| Configuration Information | 518 |
| Configuration Task List for IS-IS | 518 |
| Configuring the distance of a route | 529 |
| Change the IS-type | 529 |
| IS-IS Metric Styles | 537 |
| Configure Metric Values | 537 |
| Maximum Values in the Routing Table | 538 |
| Changing the IS-IS Metric Style in One Level Only | 538 |
| Leaking from One Level to Another | 540 |
| Sample Configuration | 541 |
| | |
| 26 IPv6 Routing | 545 |
| Protocol Overview | 545 |
| Extended Address Space | 546 |
| Stateless Autoconfiguration | 546 |
| IPv6 Headers | 546 |
| IPv6 Header Fields | 547 |
| Extension Header fields | 549 |

| | |
|---|-----|
| Addressing | 550 |
| Implementing IPv6 with FTOS | 551 |
| ICMPv6 | 554 |
| Path MTU Discovery | 555 |
| IPv6 Neighbor Discovery | 555 |
| IPv6 Neighbor Discovery of MTU packets | 556 |
| QoS for IPv6 | 557 |
| IPv6 Multicast | 557 |
| SSH over an IPv6 Transport | 557 |
| Configuration Task List for IPv6 | 558 |
| Change your CAM-Profile on an E-Series system | 558 |
| Adjust your CAM-Profile on a C-Series or S-Series | 559 |
| Assign an IPv6 Address to an Interface | 560 |
| Assign a Static IPv6 Route | 561 |
| Telnet with IPv6 | 562 |
| SNMP over IPv6 | 562 |
| Show IPv6 Information | 563 |
| Show an IPv6 Interface | 564 |
| Show IPv6 Routes | 565 |
| Show the Running-Configuration for an Interface | 567 |
| Clear IPv6 Routes | 567 |
| | |
| 27 Link Aggregation Control Protocol (LACP) | 569 |
| Introduction to Dynamic LAGs and LACP | 569 |
| Important Points to Remember | 570 |
| LACP modes | 570 |
| LACP Configuration Commands | 571 |
| LACP Configuration Tasks | 571 |
| Monitor and Debugging LACP | 573 |
| Shared LAG State Tracking | 574 |
| Configure Shared LAG State Tracking | 574 |
| Important Points about Shared LAG State Tracking | 576 |
| Configure LACP as Hitless | 576 |
| LACP Basic Configuration Example | 577 |
| | |
| 28 Layer 2 | 587 |
| Managing the MAC Address Table | 587 |
| Clear the MAC Address Table | 587 |
| Set the Aging Time for Dynamic Entries | 588 |
| Configure a Static MAC Address | 588 |
| Display the MAC Address Table | 589 |
| MAC Learning Limit | 589 |
| mac learning-limit dynamic | 590 |

| | |
|--|-----|
| mac learning-limit mac-address-sticky | 591 |
| mac learning-limit station-move | 591 |
| Learning Limit Violation Actions | 591 |
| Station Move Violation Actions | 592 |
| Recovering from Learning Limit and Station Move Violations | 592 |
| Per-VLAN MAC Learning Limit | 593 |
| NIC Teaming | 594 |
| MAC Move Optimization | 595 |
| Microsoft Clustering | 595 |
| Default Behavior | 596 |
| Configuring the Switch for Microsoft Server Clustering | 596 |
| Enable and Disable VLAN Flooding | 597 |
| Configuring Redundant Pairs | 598 |
| Important Points about Configuring Redundant Pairs | 599 |
| Restricting Layer 2 Flooding | 601 |
| Far-end Failure Detection | 602 |
| FEFD state changes | 603 |
| Important Points to Remember | 604 |
| Configuring FEFD | 604 |
| Debugging FEFD | 605 |
| | |
| 29 Link Layer Discovery Protocol (LLDP) | 607 |
| 802.1AB (LLDP) Overview | 607 |
| Protocol Data Units | 607 |
| Optional TLVs | 609 |
| Management TLVs | 609 |
| TIA-1057 (LLDP-MED) Overview | 611 |
| TIA Organizationally Specific TLVs | 611 |
| Configuring LLDP | 615 |
| Related Configuration Tasks | 615 |
| Important Points to Remember | 616 |
| LLDP Compatibility | 616 |
| CONFIGURATION versus INTERFACE Configurations | 616 |
| Enabling LLDP | 617 |
| Disabling and Undoing LLDP | 617 |
| Advertising TLVs | 618 |
| Viewing the LLDP Configuration | 619 |
| Viewing Information Advertised by Adjacent LLDP Agents | 620 |
| Configuring LLDPDU Intervals | 621 |
| Configuring Transmit and Receive Mode | 622 |
| Configuring a Time to Live | 623 |
| Debugging LLDP | 624 |
| Relevant Management Objects | 625 |

| | | |
|----|---|-----|
| 30 | Multicast Source Discovery Protocol (MSDP) | 631 |
| | Protocol Overview | 631 |
| | Anycast RP | 632 |
| | Implementation Information | 632 |
| | Configuring Multicast Source Discovery Protocol | 633 |
| | Related Configuration Tasks | 633 |
| | Enable MSDP | 638 |
| | Manage the Source-active Cache | 638 |
| | View the Source-active Cache | 639 |
| | Limit the Source-active Cache | 639 |
| | Clear the Source-active Cache | 639 |
| | Enable the Rejected Source-active Cache | 639 |
| | Accept Source-active Messages that fail the RFP Check | 640 |
| | Limit the Source-active Messages from a Peer | 642 |
| | Prevent MSDP from Caching a Local Source | 643 |
| | Prevent MSDP from Caching a Remote Source | 644 |
| | Prevent MSDP from Advertising a Local Source | 645 |
| | Log Changes in Peership States | 646 |
| | Terminate a Peership | 646 |
| | Clear Peer Statistics | 647 |
| | Debug MSDP | 648 |
| | MSDP with Anycast RP | 648 |
| | Reducing Source-active Message Flooding | 650 |
| | Specify the RP Address Used in SA Messages | 650 |
| | MSDP Sample Configurations | 654 |
| 31 | Multiple Spanning Tree Protocol (MSTP) | 659 |
| | Protocol Overview | 659 |
| | Implementation Information | 660 |
| | Configure Multiple Spanning Tree Protocol | 660 |
| | Related Configuration Tasks | 660 |
| | Enable Multiple Spanning Tree Globally | 661 |
| | Add and Remove Interfaces | 661 |
| | Create Multiple Spanning Tree Instances | 662 |
| | Influence MSTP Root Selection | 663 |
| | Interoperate with Non-FTOS Bridges | 663 |
| | Modify Global Parameters | 664 |
| | Modify Interface Parameters | 665 |
| | Configure an EdgePort | 666 |
| | Flush MAC Addresses after a Topology Change | 667 |
| | MSTP Sample Configurations | 668 |
| | Debugging and Verifying MSTP Configuration | 672 |

| | | |
|----|--|-----|
| 32 | Multicast Features | 675 |
| | Implementation Information | 675 |
| | Enable IP Multicast | 675 |
| | Multicast with ECMP | 676 |
| | Implementation Information | 676 |
| | First Packet Forwarding for Lossless Multicast | 677 |
| | Multicast Policies | 678 |
| | IPv4 Multicast Policies | 678 |
| | IPv6 Multicast Policies | 683 |
| | Multicast Traceroute | 685 |
| 33 | Open Shortest Path First (OSPFv2) | 687 |
| | Protocol Overview | 687 |
| | Networks and Neighbors | 689 |
| | Router Types | 689 |
| | Designated and Backup Designated Routers | 691 |
| | Link-State Advertisements (LSAs) | 692 |
| | Virtual Links | 693 |
| | Router Priority and Cost | 693 |
| | Implementing OSPF with FTOS | 694 |
| | Fast Convergence (OSPFv2, IPv4 only) | 695 |
| | Multi-Process OSPF (OSPFv2, IPv4 only) | 695 |
| | RFC-2328 Compliant OSPF Flooding | 696 |
| | OSPF ACK Packing | 697 |
| | OSPF Adjacency with Cisco Routers | 697 |
| | Configuration Information | 697 |
| | Configuration Task List for OSPFv2 (OSPF for IPv4) | 698 |
| | Troubleshooting OSPFv2 | 713 |
| | Sample Configurations for OSPFv2 | 715 |
| | Basic OSPFv2 Router Topology | 716 |
| 34 | PIM Sparse-Mode (PIM-SM) | 717 |
| | Implementation Information | 717 |
| | Protocol Overview | 717 |
| | Requesting Multicast Traffic | 718 |
| | Refusing Multicast Traffic | 718 |
| | Sending Multicast Traffic | 718 |
| | Important Points to Remember | 719 |
| | Configure PIM-SM | 719 |
| | Related Configuration Tasks | 719 |
| | Enable PIM-SM | 720 |
| | Configurable S,G Expiry Timers | 721 |

| | |
|---|-----|
| Configure a Static Rendezvous Point | 722 |
| Override Bootstrap Router Updates | 723 |
| Configure a Designated Router | 723 |
| Create Multicast Boundaries and Domains | 724 |
| PIM-SM Graceful Restart | 724 |
| Monitoring PIM | 725 |
| | |
| 35 Port Monitoring | 727 |
| Important Points to Remember | 727 |
| Port Monitoring on E-Series | 728 |
| E-Series TeraScale | 728 |
| E-Series ExaScale | 729 |
| Port Monitoring on C-Series and S-Series | 729 |
| Configuring Port Monitoring | 732 |
| Flow-based Monitoring | 733 |
| | |
| 36 Private VLANs (PVLAN) | 735 |
| Private VLAN Concepts | 735 |
| Private VLAN Commands | 737 |
| Private VLAN Configuration Task List | 738 |
| Private VLAN Configuration Example | 741 |
| | |
| 37 Per-VLAN Spanning Tree Plus (PVST+) | 745 |
| Protocol Overview | 745 |
| Implementation Information | 746 |
| Configure Per-VLAN Spanning Tree Plus | 746 |
| Related Configuration Tasks | 746 |
| Enable PVST+ | 747 |
| Disable PVST+ | 747 |
| Influence PVST+ Root Selection | 747 |
| Modify Global PVST+ Parameters | 749 |
| Modify Interface PVST+ Parameters | 750 |
| Configure an EdgePort | 751 |
| PVST+ in Multi-vendor Networks | 752 |
| PVST+ Extended System ID | 752 |
| PVST+ Sample Configurations | 753 |
| | |
| 38 Quality of Service (QoS) | 757 |
| Implementation Information | 759 |
| Port-based QoS Configurations | 759 |
| Set dot1p Priorities for Incoming Traffic | 760 |
| Honor dot1p Priorities on Ingress Traffic | 760 |

| | |
|--|-----|
| Configure Port-based Rate Policing | 761 |
| Configure Port-based Rate Limiting | 762 |
| Configure Port-based Rate Shaping | 763 |
| Policy-based QoS Configurations | 764 |
| Classify Traffic | 764 |
| Create a QoS Policy | 768 |
| Create Policy Maps | 771 |
| QoS Rate Adjustment | 775 |
| Strict-priority Queueing | 776 |
| Weighted Random Early Detection | 776 |
| Create WRED Profiles | 777 |
| Apply a WRED profile to traffic | 778 |
| Display Default and Configured WRED Profiles | 778 |
| Display WRED Drop Statistics | 779 |
| Pre-calculating Available QoS CAM Space | 780 |
| | |
| 39 Routing Information Protocol (RIP) | 783 |
| Protocol Overview | 783 |
| RIPv1 | 783 |
| RIPv2 | 784 |
| Implementation Information | 784 |
| Configuration Information | 784 |
| Configuration Task List for RIP | 784 |
| RIP Configuration Example | 792 |
| | |
| 40 Remote Monitoring (RMON) | 799 |
| Implementation | 799 |
| Fault Recovery | 800 |
| | |
| 41 Rapid Spanning Tree Protocol (RSTP) | 805 |
| Protocol Overview | 805 |
| Configuring Rapid Spanning Tree | 805 |
| Related Configuration Tasks | 805 |
| Important Points to Remember | 806 |
| RSTP and VLT | 806 |
| Configure Interfaces for Layer 2 Mode | 807 |
| Enable Rapid Spanning Tree Protocol Globally | 808 |
| Add and Remove Interfaces | 811 |
| Modify Global Parameters | 811 |
| Modify Interface Parameters | 812 |
| Configure an EdgePort | 813 |
| Influence RSTP Root Selection | 814 |

| | |
|---|------------|
| SNMP Traps for Root Elections and Topology Changes | 815 |
| Fast Hellos for Link State Detection | 815 |
| 42 Security | 817 |
| AAA Accounting | 817 |
| Configuration Task List for AAA Accounting | 817 |
| AAA Authentication | 820 |
| Configuration Task List for AAA Authentication | 820 |
| AAA Authorization | 823 |
| Privilege Levels Overview | 823 |
| Configuration Task List for Privilege Levels | 824 |
| RADIUS | 828 |
| RADIUS Authentication and Authorization | 829 |
| Configuration Task List for RADIUS | 830 |
| TACACS+ | 833 |
| Configuration Task List for TACACS+ | 833 |
| TACACS+ Remote Authentication and Authorization | 835 |
| Command Authorization | 837 |
| Protection from TCP Tiny and Overlapping Fragment Attacks | 837 |
| SCP and SSH | 837 |
| Using SCP with SSH to copy a software image | 839 |
| Secure Shell Authentication | 840 |
| Troubleshooting SSH | 843 |
| Telnet | 843 |
| Trace Lists | 844 |
| Configuration Tasks for Trace Lists | 844 |
| VTY Line and Access-Class Configuration | 850 |
| VTY Line Local Authentication and Authorization | 850 |
| VTY Line Remote Authentication and Authorization | 851 |
| VTY MAC-SA Filter Support | 851 |
| 43 Service Provider Bridging | 853 |
| VLAN Stacking | 853 |
| Important Points to Remember | 854 |
| Configure VLAN Stacking | 854 |
| Create Access and Trunk Ports | 855 |
| Enable VLAN-Stacking for a VLAN | 855 |
| Configure the Protocol Type Value for the Outer VLAN Tag | 856 |
| FTOS Options for Trunk Ports | 856 |
| Debug VLAN Stacking | 857 |
| VLAN Stacking in Multi-vendor Networks | 858 |
| VLAN Stacking Packet Drop Precedence | 864 |
| Enable Drop Eligibility | 865 |

| | |
|---|------------|
| Honor the Incoming DEI Value | 865 |
| Mark Egress Packets with a DEI Value | 866 |
| Dynamic Mode CoS for VLAN Stacking | 866 |
| Layer 2 Protocol Tunneling | 869 |
| Implementation Information | 871 |
| Enable Layer 2 Protocol Tunneling | 871 |
| Specify a Destination MAC Address for BPDUs | 872 |
| Rate-limit BPDUs on the E-Series | 872 |
| Rate-limit BPDUs on the C-Series and S-Series | 872 |
| Debug Layer 2 Protocol Tunneling | 873 |
| Provider Backbone Bridging | 873 |
| 44 sFlow | 875 |
| Overview | 875 |
| Implementation Information | 876 |
| Important Points to Remember | 876 |
| Enable and Disable sFlow | 877 |
| Enable and Disable on an Interface | 877 |
| sFlow Show Commands | 878 |
| Show sFlow Globally | 878 |
| Show sFlow on an Interface | 878 |
| Show sFlow on a Line Card | 879 |
| Specify Collectors | 880 |
| Polling Intervals | 880 |
| Sampling Rate | 880 |
| Sub-sampling | 881 |
| Back-off Mechanism | 882 |
| sFlow on LAG ports | 882 |
| Extended sFlow | 882 |
| Important Points to Remember | 883 |
| 45 Simple Network Management Protocol (SNMP) | 885 |
| Protocol Overview | 885 |
| Implementation Information | 885 |
| Configure Simple Network Management Protocol | 886 |
| Related Configuration Tasks | 886 |
| Important Points to Remember | 886 |
| Setting up SNMP | 886 |
| Create a Community | 887 |
| Setting Up User-based Security (SNMPv3) | 887 |
| Read Managed Object Values | 889 |
| Write Managed Object Values | 890 |
| Configure Contact and Location Information using SNMP | 890 |

| | |
|--|------------|
| Subscribe to Managed Object Value Updates using SNMP | 891 |
| Copy Configuration Files Using SNMP | 895 |
| Manage VLANs using SNMP | 901 |
| Create a VLAN | 901 |
| Assign a VLAN Alias | 901 |
| Display the Ports in a VLAN | 902 |
| Add Tagged and Untagged Ports to a VLAN | 904 |
| Managing Overload on Startup | 905 |
| Enable and Disable a Port using SNMP | 906 |
| Fetch Dynamic MAC Entries using SNMP | 906 |
| Deriving Interface Indices | 908 |
| Monitor Port-channels | 909 |
| Troubleshooting SNMP Operation | 910 |
| | |
| 46 Stacking | 911 |
| S-Series Stacking Overview | 912 |
| Stack Management Roles | 912 |
| Stack Master Election | 913 |
| Virtual IP | 914 |
| Failover Roles | 914 |
| MAC Addressing on S-Series Stacks | 914 |
| Stacking LAG | 916 |
| Supported Stacking Topologies | 916 |
| High Availability on S-Series Stacks | 917 |
| Management Access on S-Series Stacks | 918 |
| Important Points to Remember - S4810 and S4820T Stacking | 919 |
| S-Series Stacking Installation Tasks | 920 |
| Create an S-Series Stack | 920 |
| Add Units to an Existing S-Series Stack | 926 |
| Split an S-Series Stack | 929 |
| S-Series Stacking Configuration Tasks | 930 |
| Assign Unit Numbers to Units in an S-Series Stack | 930 |
| Create a Virtual Stack Unit on an S-Series Stack | 930 |
| Display Information about an S-Series Stack | 930 |
| Influence Management Unit Selection on an S-Series Stack | 933 |
| Manage Redundancy on an S-Series Stack | 934 |
| Reset a Unit on an S-Series Stack | 934 |
| Verifying a Stack Configuration | 934 |
| LED Status Indicators on an S4810 or S4820T Stack | 934 |
| Display Status of Stacking Ports | 935 |
| Removing Units or Front End Ports from a Stack | 937 |
| Remove a Unit from an S-Series Stack | 937 |
| Remove Front End Port Stacking | 938 |

| | |
|---|------------|
| Troubleshoot an S-Series Stack | 938 |
| Recover from Stack Link Flaps | 938 |
| Recover from a Card Problem State on an S-Series Stack | 939 |
| Recover from a Card Mismatch State on an S-Series Stack | 940 |
| 47 Storm Control | 943 |
| Configure Storm Control | 943 |
| Configure storm control from INTERFACE mode | 943 |
| Configure storm control from CONFIGURATION mode | 944 |
| 48 Spanning Tree Protocol (STP)..... | 945 |
| Protocol Overview | 945 |
| Configuring Spanning Tree | 945 |
| Related Configuration Tasks | 945 |
| Important Points to Remember | 946 |
| Configuring Interfaces for Layer 2 Mode | 946 |
| Enabling Spanning Tree Protocol Globally | 948 |
| Adding an Interface to the Spanning Tree Group | 950 |
| Removing an Interface from the Spanning Tree Group | 950 |
| Modifying Global Parameters | 951 |
| Modifying Interface STP Parameters | 952 |
| Enabling PortFast | 952 |
| Preventing Network Disruptions with BPDU Guard | 953 |
| STP Root Selection | 955 |
| STP Root Guard | 956 |
| Root Guard Scenario | 956 |
| Root Guard Configuration | 958 |
| SNMP Traps for Root Elections and Topology Changes | 958 |
| Configuring Spanning Trees as Hitless | 959 |
| STP Loop Guard | 959 |
| Loop Guard Scenario | 959 |
| Loop Guard Configuration | 962 |
| Displaying STP Guard Configuration | 963 |
| 49 System Time and Date | 965 |
| Network Time Protocol | 965 |
| Protocol Overview | 966 |
| Implementation Information | 967 |
| Configuring Network Time Protocol | 967 |
| Enable NTP | 968 |
| Set the Hardware Clock with the Time Derived from NTP | 968 |
| Configure NTP broadcasts | 969 |

| | |
|--|-------------|
| Disable NTP on an interface | 969 |
| Configure a source IP address for NTP packets | 969 |
| Configure NTP authentication | 970 |
| FTOS Time and Date | 973 |
| Configuring time and date settings | 973 |
| Set daylight saving time | 976 |
| 50 Uplink Failure Detection (UFD) | 981 |
| Feature Description | 981 |
| How Uplink Failure Detection Works | 982 |
| UFD and NIC Teaming | 983 |
| Important Points to Remember | 984 |
| Configuring Uplink Failure Detection | 985 |
| Clearing a UFD-Disabled Interface | 986 |
| Displaying Uplink Failure Detection | 988 |
| Sample Configuration: Uplink Failure Detection | 991 |
| 51 Upgrade Procedures | 993 |
| Find the upgrade procedures | 993 |
| Get Help with upgrades | 993 |
| 52 Virtual LANs (VLAN) | 995 |
| Default VLAN | 996 |
| Port-Based VLANs | 997 |
| VLANs and Port Tagging | 997 |
| Configuration Task List for VLANs | 998 |
| VLAN Interface Counters | 1002 |
| Native VLANs | 1003 |
| Enable Null VLAN as the Default VLAN | 1004 |
| 53 Virtual Link Trunking (VLT) | 1005 |
| Overview | 1005 |
| VLT on Core Switches | 1006 |
| Enhanced VLT | 1008 |
| VLT Terminology | 1008 |
| Configuring Virtual Link Trunking | 1009 |
| Important Points to Remember | 1009 |
| Configuration Notes | 1010 |
| RSTP and VLT | 1014 |
| VLT Bandwidth Monitoring | 1014 |
| VLT and Stacking | 1015 |
| VLT and IGMP Snooping | 1015 |

| | |
|---|-------------|
| VLT Port Delayed Restoration | 1015 |
| PIM-Sparse Mode Support on VLT | 1016 |
| RSTP Configuration | 1017 |
| VLT Configuration Procedure | 1018 |
| Verifying a VLT Configuration | 1032 |
| Sample Configuration: Virtual Link Trunking | 1037 |
| Troubleshooting VLT | 1040 |
| Reconfiguring Stacked Switches as VLT | 1041 |
| 54 Virtual Router Redundancy Protocol (VRRP) | 1043 |
| VRRP Overview | 1043 |
| VRRP Benefits | 1045 |
| VRRP Implementation | 1045 |
| VRRP Configuration | 1046 |
| Configuration Task List for VRRP | 1046 |
| VRRP initialization delay | 1056 |
| Sample Configurations | 1057 |
| VRRP for IPv4 Configuration | 1057 |
| VRRP for IPv6 Configuration | 1059 |
| VRRP in VRF Configuration | 1061 |
| 55 S-Series Debugging and Diagnostics | 1067 |
| Offline diagnostics | 1067 |
| Important Points to Remember | 1068 |
| Running Offline Diagnostics | 1068 |
| Trace logs | 1071 |
| Auto Save on Crash or Rollover | 1072 |
| Last restart reason (S4810 and S4820T) | 1072 |
| Hardware watchdog timer | 1072 |
| show hardware commands (S4810 and S4820T) | 1073 |
| Environmental monitoring | 1074 |
| Recognize an overtemperature condition | 1074 |
| Troubleshoot an overtemperature condition | 1075 |
| Recognize an under-voltage condition | 1075 |
| Troubleshoot an under-voltage condition | 1076 |
| Buffer tuning | 1076 |
| Deciding to tune buffers | 1078 |
| Buffer tuning commands | 1079 |
| Sample buffer profile configuration | 1081 |
| Troubleshooting packet loss | 1082 |
| Displaying Drop Counters | 1082 |
| Dataplane Statistics | 1084 |
| Displaying Stack Port Statistics | 1086 |

| | |
|--|------|
| Displaying Stack Member Counters | 1086 |
| Application core dumps | 1087 |
| Mini core dumps | 1087 |
| TCP dumps | 1088 |
| | |
| 56 Standards Compliance | 1091 |
| IEEE Compliance | 1091 |
| RFC and I-D Compliance | 1092 |
| MIB Location | 1103 |
| | |
| 57 Index | 1105 |

About this Guide

Objectives

This guide describes the protocols and features supported by the Force10 Operating System (FTOS) and provides configuration instructions and examples for implementing them. It supports the system platforms E-Series, C-Series, and S-Series.

Though this guide contains information on protocols, it is not intended to be a complete reference. This guide is a reference for configuring protocols on Dell Force10 systems. For complete information on protocols, refer to other documentation including IETF Requests for Comment (RFCs). The instructions in this guide cite relevant RFCs, and [Chapter 56, Standards Compliance](#) contains a complete list of the supported RFCs and Management Information Base files (MIBs).

Audience

This document is intended for system administrators who are responsible for configuring and maintaining networks and assumes you are knowledgeable in Layer 2 and Layer 3 networking technologies.

Conventions





This document uses the following conventions to describe command syntax:

| Convention | Description |
|------------------|--|
| keyword | Keywords are in bold and should be entered in the CLI as listed. |
| <i>parameter</i> | Parameters are in italics and require a number or word to be entered in the CLI. |
| {X} | Keywords and parameters within braces must be entered in the CLI. |
| [X] | Keywords and parameters within brackets are optional. |
| x y | Keywords and parameters separated by bar require you to choose one. |

Information Symbols

Table 1-1 describes symbols contained in this guide.

Table 1-1. Information Symbols

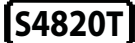
| Symbol | Warning | Description |
|---|-----------------------------------|--|
|  | Note | This symbol informs you of important operational information. |
|  | Platform Specific Feature | This symbol informs you of a feature that supported on one or two platforms only: E is for E-Series, C is for C-Series, S is for S-Series. |
|  | E-Series Specific Feature/Command | If a feature or command applies to only one of the E-Series platforms, a separate symbol calls this to attention: E _t for the TeraScale or E _x for the ExaScale. |
|  | S4810 | This symbol indicates that the selected feature is supported on the S4810 but not on other S-Series systems. |
|  | S4820T | This symbol indicates that the selected feature is supported on the S4820T but not on other S-Series systems. |

Related Documents

For more information about the system refer to the following documents:

- *FTOS Command Reference*
- *Installing and Maintaining the S4810 System*
- *Installing and Maintaining the S4820T System*
- *FTOS Release Notes*

Configuration Fundamentals

The FTOS Command Line Interface (CLI) is a text-based interface through which you can configure interfaces and protocols. The CLI is largely the same for the E-Series, C-Series, and S-Series with the exception of some commands and command outputs. The CLI is structured in modes for security and management purposes. Different sets of commands are available in each mode, and you can limit user access to modes using privilege levels.

In FTOS, after a command is enabled, it is entered into the running configuration file. You can view the current configuration for the whole system or for a particular CLI mode. To save the current configuration copy the running configuration to another location.



Note: Due to a differences in hardware architecture and the continued system development, features may occasionally differ between the platforms. These differences are identified by the information symbols shown on [Table 1-1, "Information Symbols," in About this Guide.](#)

Accessing the Command Line

Access the command line through a serial console port or a Telnet session as shown in the example below. When the system successfully boots, you enter the command line in the EXEC mode.



Note: You must have a password configured on a virtual terminal line before you can Telnet into the system. Therefore, you must use a console connection when connecting to the system for the first time.

```
telnet 172.31.1.53
Trying 172.31.1.53...
Connected to 172.31.1.53.
Escape character is '^]'.
Login: username
Password:
FTOS>
```

CLI Modes

Different sets of commands are available in each mode. A command found in one mode cannot be executed from another mode (with the exception of EXEC mode commands preceded by the command `do`; see [The do Command in the Configuration Fundamentals chapter](#)). You can set user access rights to commands and command modes using privilege levels; for more information on privilege levels and security options, refer to [Privilege Levels Overview in the Security chapter](#).

The FTOS CLI is divided into three major mode levels:

- **EXEC mode** is the default mode and has a privilege level of 1, which is the most restricted level. Only a limited selection of commands is available, notably show commands, which allow you to view system information.
- **EXEC Privilege mode** has commands to view configurations, clear counters, manage configuration files, run diagnostics, and enable or disable debug operations. The privilege level is 15, which is unrestricted. You can configure a password for this mode; refer to [Configure the Enable Password in the Getting Started chapter](#).
- **CONFIGURATION mode** enables you to configure security features, time settings, set logging and SNMP functions, configure static ARP and MAC addresses, and set line cards on the system.

Beneath CONFIGURATION mode are sub-modes that apply to interfaces, protocols, and features. The example below illustrates this sub-mode command structure. Two sub-CONFIGURATION modes are important when configuring the chassis for the first time:

- **INTERFACE sub-mode** is the mode in which you configure Layer 2 and Layer 3 protocols and IP services specific to an interface. An interface can be physical (Management interface, 1-Gigabit Ethernet, or 10-Gigabit Ethernet, or SONET) or logical (Loopback, Null, port channel, or VLAN).
- **LINE sub-mode** is the mode in which you to configure the console and virtual terminal lines.



Note: At any time, entering a question mark (?) will display the available command options. For example, when you are in CONFIGURATION mode, entering the question mark first will list all available commands, including the possible sub-modes.

```
EXEC
EXEC Privilege
CONFIGURATION
  ARCHIVE
  AS-PATH ACL
  INTERFACE
    GIGABIT ETHERNET
    10 GIGABIT ETHERNET
    INTERFACE RANGE
    LOOP BACK
    MANAGEMENT ETHERNET
    NULL
    PORT-CHANNEL
    SONET
    VLAN
    VRRP
```

IP
 IPv6
 IP COMMUNITY-LIST
 IP ACCESS-LIST
 STANDARD ACCESS-LIST
 EXTENDED ACCESS-LIST
 LINE
 AUXILLIARY
 CONSOLE
 VIRTUAL TERMINAL
 MAC ACCESS-LIST
 MONITOR SESSION
 MULTIPLE SPANNING TREE
 Per-VLAN SPANNING TREE
 PREFIX-LIST
 RAPID SPANNING TREE
 REDIRECT
 ROUTE-MAP
 ROUTER BGP
 ROUTER ISIS
 ROUTER OSPF
 ROUTER RIP
 SPANNING TREE
 TRACE-LIST



Note: In the example above, SONET is not supported on the S4810 or S4820T.

Navigating CLI Modes

The FTOS prompt changes to indicate the CLI mode. [Table 2-1, "FTOS Command Modes," in Configuration Fundamentals](#) lists the CLI mode, its prompt, and information on how to access and exit this CLI mode. You must move linearly through the command modes, with the exception of the end command which takes you directly to EXEC Privilege mode; the exit command moves you up one command mode level.



Note: Sub-CONFIGURATION modes all have the letters “conf” in the prompt with additional modifiers to identify the mode and slot/port information. These are shown in [Table 2-1, "FTOS Command Modes," in Configuration Fundamentals](#).

Table 2-1. FTOS Command Modes

| CLI Command Mode | Prompt | Access Command |
|------------------|--------|--|
| EXEC | FTOS> | Access the router through the console or Telnet. |

Table 2-1. FTOS Command Modes (continued)



| CLI Command Mode | Prompt | Access Command | |
|---|---|---|-------------------------|
| EXEC Privilege | FTOS# | <ul style="list-style-type: none"> From EXEC mode, enter the command enable. From any other mode, use the command end. | |
| CONFIGURATION | FTOS(conf)# | <ul style="list-style-type: none"> From EXEC privilege mode, enter the command configure. From every mode except EXEC and EXEC Privilege, enter the command exit. | |
|  | Note: Access all of the following modes from CONFIGURATION mode. | | |
|  | Note: SONET is not supported on the S4810 or S4820T. | | |
| ARCHIVE | FTOS(conf-archive) | archive | |
| AS-PATH ACL | FTOS(config-as-path)# | ip as-path access-list | |
| INTERFACE modes | Gigabit Ethernet Interface | FTOS(conf-if-gi-0/0)# | interface |
| | 10 Gigabit Ethernet Interface | FTOS(conf-if-te-0/0)# | |
| | Interface Range | FTOS(conf-if-range)# | |
| | Loopback Interface | FTOS(conf-if-lo-0)# | |
| | Management Ethernet Interface | FTOS(conf-if-ma-0/0)# | |
| | Null Interface | FTOS(conf-if-nu-0)# | |
| | Port-channel Interface | FTOS(conf-if-po-0)# | |
| | SONET Interface | FTOS(conf-if-so-0/0)# | |
| VLAN Interface | FTOS(conf-if-vl-0)# | | |
| IP ACCESS-LIST | STANDARD ACCESS-LIST | FTOS(config-std-nacl)# | ip access-list standard |
| | EXTENDED ACCESS-LIST | FTOS(config-ext-nacl)# | ip access-list extended |
| IP COMMUNITY-LIST | FTOS(config-community-list)# | ip community-list | |
| LINE | AUXILIARY | FTOS(config-line-aux)# | line |
| | CONSOLE | FTOS(config-line-console)# | |
| | VIRTUAL TERMINAL | FTOS(config-line-vty)# | |

Table 2-1. FTOS Command Modes (continued)

| CLI Command Mode | Prompt | Access Command |
|-----------------------------|---------------------------|--|
| MAC ACCESS-LIST | STANDARD ACCESS-LIST | FTOS(config-std-macl)# mac access-list standard |
| | EXTENDED ACCESS-LIST | FTOS(config-ext-macl)# mac access-list extended |
| MULTIPLE SPANNING TREE | FTOS(config-mstp)# | protocol spanning-tree mstp |
| Per-VLAN SPANNING TREE Plus | FTOS(config-pvst)# | protocol spanning-tree pvst |
| PREFIX-LIST | FTOS(conf-nprefixl)# | ip prefix-list |
| RAPID SPANNING TREE | FTOS(config-rstp)# | protocol spanning-tree rstp |
| REDIRECT | FTOS(conf-redirect-list)# | ip redirect-list |
| ROUTE-MAP | FTOS(config-route-map)# | route-map |
| ROUTER BGP | FTOS(conf-router_bgp)# | router bgp |
| ROUTER ISIS | FTOS(conf-router_isis)# | router isis |
| ROUTER OSPF | FTOS(conf-router_ospf)# | router ospf |
| ROUTER RIP | FTOS(conf-router_rip)# | router rip |
| SPANNING TREE | FTOS(config-span)# | protocol spanning-tree 0 |
| TRACE-LIST | FTOS(conf-trace-acl)# | ip trace-list |

The following example illustrates how to change the command mode from CONFIGURATION mode to PROTOCOL SPANNING TREE.

```
FTOS(conf)#protocol spanning-tree 0
FTOS(config-span)#
```

The do Command

Enter an EXEC mode command from any CONFIGURATION mode (CONFIGURATION, INTERFACE, SPANNING TREE, etc.) without returning to EXEC mode by preceding the EXEC mode command with the command `do`. The following example illustrates the `do` command.



Note: The following commands cannot be modified by the `do` command: `enable`, `disable`, `exit`, and `configure`.

```
FTOS(conf)#do show linecard all
```

```
-- Line cards --
```

| Slot | Status | NxtBoot | ReqTyp | CurTyp | Version | Ports |
|------|-------------|---------|--------|--------|---------|-------|
| 0 | not present | | | | | |
| 1 | not present | | | | | |
| 2 | online | online | E48TB | E48TB | 1-1-463 | 48 |
| 3 | not present | | | | | |
| 4 | not present | | | | | |
| 5 | online | online | E48VB | E48VB | 1-1-463 | 48 |
| 6 | not present | | | | | |
| 7 | not present | | | | | |

The following example illustrates the do command for the S4810 and S4820T:

```
FTOS(conf)#do show system brief
```

```
Stack MAC : 00:01:e8:8b:5d:b9
```

```
Reload-Type : normal-reload [Next boot : normal-reload]
```

```
-- Stack Info --
```

| Unit | UnitType | Status | ReqTyp | CurTyp | Version | Ports |
|------|------------|-------------|--------|--------|--------------|-------|
| 0 | Management | online | S4820 | S4820 | 2D2-1-0-0-70 | 64 |
| 1 | Member | not present | | | | |
| 2 | Member | not present | | | | |
| 3 | Member | not present | | | | |
| 4 | Member | not present | | | | |
| 5 | Member | not present | | | | |
| 6 | Member | not present | | | | |
| 7 | Member | not present | | | | |
| 8 | Member | not present | | | | |
| 9 | Member | not present | | | | |
| 10 | Member | not present | | | | |
| 11 | Member | not present | | | | |

```
-- Power Supplies --
```

| Unit | Bay | Status | Type |
|------|-----|--------|---------|
| 0 | 0 | up | UNKNOWN |
| 0 | 1 | absent | |

```
-- Fan Status --
```

| Unit | Bay | TrayStatus | Fan0 | Speed | Fan1 | Speed |
|------|-----|------------|------|-------|------|-------|
|------|-----|------------|------|-------|------|-------|

```
0    0    absent or down
0    1    up           up           18995    up           18995
Speed in RPM
```

Undoing Commands

When you enter a command, the command line is added to the running configuration file. Disable a command and remove it from the running-config by entering the original command preceded by the command `no`. For example, to delete an ip address configured on an interface, use the `no ip address ip-address` command, as shown in the following example.



Note: Use the `help` or `?` command as discussed in [Obtaining Help in the Configuration Fundamentals chapter](#) command to help you construct the “no” form of a command.

```
FTOS(conf)#interface gigabitethernet 4/17
FTOS(conf-if-gi-4/17)#ip address 192.168.10.1/24
FTOS(conf-if-gi-4/17)#show config
!
interface GigabitEthernet 4/17
 ip address 192.168.10.1/24
 no shutdown
FTOS(conf-if-gi-4/17)#no ip address
FTOS(conf-if-gi-4/17)#show config
!
interface GigabitEthernet 4/17
 no ip address
 no shutdown
```

Layer 2 protocols are disabled by default. Enable them using the `no disable` command. For example, in `PROTOCOL SPANNING TREE` mode, enter `no disable` to enable Spanning Tree.

Obtaining Help

Obtain a list of keywords and a brief functional description of those keywords at any CLI mode using the `?` or `help` command:

- Enter `?` at the prompt or after a keyword to list the keywords available in the current mode.
 - `?` after a prompt lists all of the available keywords. The output of this command is the same for the `help` command.

```
FTOS#?
calendar                Manage the hardware calendar
cd                       Change current directory
```

```

change          Change subcommands
clear           Reset functions
clock           Manage the system clock
configure       Configuring from terminal
copy            Copy from one file to another
debug           Debug functions
--More--

```

- ? after a partial keyword lists all of the keywords that begin with the specified letters.

```

FTOS (conf) #cl?
class-map
clock
FTOS (conf) #cl

```

- A keyword followed by [space]? lists all of the keywords that can follow the specified keyword.

```

FTOS (conf) #clock ?
summer-time      Configure summer (daylight savings) time
timezone         Configure time zone
FTOS (conf) #clock

```

Entering and Editing Commands

When entering commands:

- The CLI is not case sensitive.
- You can enter partial CLI keywords.
 - You must enter the minimum number of letters to uniquely identify a command. For example, `cl` cannot be entered as a partial keyword because both the `clock` and `class-map` commands begin with the letters “`cl`.” `clo`, however, can be entered as a partial keyword because only one command begins with those three letters.
- The TAB key auto-completes keywords in commands. You must enter the minimum number of letters to uniquely identify a command.
- The UP and DOWN arrow keys display previously entered commands (see [Command History in the Configuration Fundamentals chapter](#)).
- The BACKSPACE and DELETE keys erase the previous letter.
- Key combinations are available to move quickly across the command line, as described in [Table 2-2, "Short-Cut Keys and their Actions," in Configuration Fundamentals](#).

Table 2-2. Short-Cut Keys and their Actions

| Key Combination | Action |
|-----------------|--|
| CNTL-A | Moves the cursor to the beginning of the command line. |
| CNTL-B | Moves the cursor back one character. |

Table 2-2. Short-Cut Keys and their Actions (continued)

| Key Combination | Action |
|-----------------|--|
| CNTL-D | Deletes character at cursor. |
| CNTL-E | Moves the cursor to the end of the line. |
| CNTL-F | Moves the cursor forward one character. |
| CNTL-I | Completes a keyword. |
| CNTL-K | Deletes all characters from the cursor to the end of the command line. |
| CNTL-L | Re-enters the previous command. |
| CNTL-N | Return to more recent commands in the history buffer after recalling commands with CTRL-P or the UP arrow key. |
| CNTL-P | Recalls commands, beginning with the last command |
| CNTL-R | Re-enters the previous command. |
| CNTL-U | Deletes the line. |
| CNTL-W | Deletes the previous word. |
| CNTL-X | Deletes the line. |
| CNTL-Z | Ends continuous scrolling of command outputs. |
| Esc B | Moves the cursor back one word. |
| Esc F | Moves the cursor forward one word. |
| Esc D | Deletes all characters from the cursor to the end of the word. |

Command History

FTOS maintains a history of previously-entered commands for each mode. For example:

- When you are in EXEC mode, the UP and DOWN arrow keys display the previously-entered EXEC mode commands.
- When you are in CONFIGURATION mode, the UP or DOWN arrows keys recall the previously-entered CONFIGURATION mode commands.

Filtering show Command Outputs

Filter the output of a show command to display specific information by adding | [except | find | grep | no-more | save] *specified_text* after the command. The variable *specified_text* is the text for which you are filtering and it IS case sensitive unless the ignore-case sub-option is implemented.

Starting with FTOS 7.8.1.0, the grep command accepts an ignore-case sub-option that forces the search to case-*insensitive*. For example, the commands:

- `show run | grep Ethernet` returns a search result with instances containing a capitalized “Ethernet,” such as `interface GigabitEthernet 0/0`.

- `show run | grep ethernet` would not return that search result because it only searches for instances containing a non-capitalized “ethernet.”

Executing the command `show run | grep Ethernet ignore-case` would return instances containing both “Ethernet” and “ethernet.”

- `grep` displays only the lines containing specified text. The following example shows this command used in combination with the command `show linecard all`.

```
FTOS(conf)#do show linecard all | grep 0
0    not present
```



Note: FTOS accepts a space or no space before and after the pipe. To filter on a phrase with spaces, underscores, or ranges, enclose the phrase with double quotation marks.

- `except` displays text that does not match the specified text. The following example shows this command used in combination with the command `show linecard all`.

```
FTOS#show linecard all | except 0
```

```
-- Line cards --
```

| Slot | Status | NxtBoot | ReqTyp | CurTyp | Version | Ports |
|------|--------|---------|--------|--------|---------|-------|
|------|--------|---------|--------|--------|---------|-------|

```
-----
```

| | | | | | | |
|---|-------------|--|--|--|--|--|
| 2 | not present | | | | | |
| 3 | not present | | | | | |
| 4 | not present | | | | | |
| 5 | not present | | | | | |
| 6 | not present | | | | | |

- The following example shows the `grep` command used with the `show system` command on an S4810 or S4820T:

```
FTOS(conf)#do show system brief | grep 10
```

```
10 Member not present
```

```
FTOS(conf)#do show system brief | except 10
```

```
Stack MAC : 00:01:e8:8b:5d:b9
```

```
Reload-Type : normal-reload [Next boot : normal-reload]
```

```
-- Stack Info --
```

| Unit | UnitType | Status | ReqTyp | CurTyp | Version | Ports |
|------|----------|--------|--------|--------|---------|-------|
|------|----------|--------|--------|--------|---------|-------|

```
-----
```

| | | | | | | |
|---|------------|-------------|-------|-------|--------------|----|
| 0 | Management | online | S4820 | S4820 | 2D2-1-0-0-70 | 64 |
| 1 | Member | not present | | | | |
| 2 | Member | not present | | | | |
| 3 | Member | not present | | | | |
| 4 | Member | not present | | | | |
| 5 | Member | not present | | | | |

```

6 Member not present
7 Member not present
8 Member not present
9 Member not present
11 Member not present
-- Power Supplies --
Unit Bay Status Type
-----
0 0 up UNKNOWN
0 1 absent
-- Fan Status --
Unit Bay TrayStatus Fan0 Speed Fan1 Speed
-----
0 0 absent or down
0 1 up up 18950 up 18950
Speed in RPM
FTOS(conf)#do show system brief | find 10
10 Member not present
11 Member not present
-- Power Supplies --
Unit Bay Status Type
-----
0 0 up UNKNOWN
0 1 absent
-- Fan Status --
Unit Bay TrayStatus Fan0 Speed Fan1 Speed
-----
0 0 absent or down
0 1 up up 18950 up 18950
Speed in RPM

```

- **find** displays the output of the show command beginning from the first occurrence of specified text. The following example shows this command used in combination with the command show linecard all.

```

FTOS(conf)#do show linecard all | find 0
 0 not present
 1 not present
 2 online      online      E48TB      E48TB      1-1-463    48
 3 not present
 4 not present
 5 online      online      E48VB      E48VB      1-1-463    48
 6 not present

```

7 not present

- `display` displays additional configuration information.
- `no-more` displays the output all at once rather than one screen at a time. This is similar to the command `terminal length` except that the `no-more` option affects the output of the specified command only.
- `save` copies the output to a file for future reference.



Note: You can filter a single command output multiple times. The `save` option should be the last option entered. For example:

```
FTOS# command | grep regular-expression | except regular-expression | grep
other-regular-expression | find regular-expression | save
```

Multiple Users in Configuration mode

FTOS notifies all users in the event that there are multiple users logged into CONFIGURATION mode. A warning message indicates the username, type of connection (console or vty), and in the case of a vty connection, the IP address of the terminal on which the connection was established. For example:

- On the system that telnets into the switch, [Message 1](#) appears:

Message 1 Multiple Users in Configuration mode Telnet Message

```
% Warning: The following users are currently configuring the system:

User "<username>" on line console0
```

- On the system that is connected over the console, [Message 2](#) appears:

Message 2 Multiple Users in Configuration mode Telnet Message

```
% Warning: User "<username>" on line vty0 "10.11.130.2" is in configuration mode
```

If either of these messages appears, Dell Force10 recommends that you coordinate with the users listed in the message so that you do not unintentionally overwrite each other's configuration changes.

Getting Started

This chapter contains the following major sections:

- [Default Configuration](#)
- [Configure a Host Name](#)
- [Access the System Remotely](#)
- [Configure the Enable Password](#)
- [Configuration File Management](#)
- [File System Management](#)

When you power up the chassis, the system performs a Power-On Self Test (POST) during which Route Processor Module (RPM), Switch Fabric Module (SFM), and line card status LEDs blink green. The system then loads FTOS and boot messages scroll up the terminal window during this process. No user interaction is required if the boot process proceeds without interruption.

When the boot process is complete, the RPM and line card status LEDs remain online (green), and the console monitor displays the EXEC mode prompt.

For details on using the Command Line Interface (CLI), refer to [Accessing the Command Line in the Configuration Fundamentals chapter](#).

Console access

The S4810 has 2 management ports available for system access: a serial console port and an Out-of-Bounds (OOB) port.

Serial console

The RJ-45/RS-232 console port is labeled on the S4810 chassis. It is in the upper right-hand side, as you face the I/O side of the chassis.

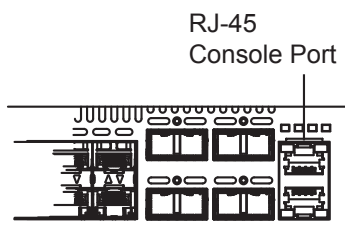

The RJ-45/RS-232 console port is labeled on the S4820T chassis. It is to the left of Fan Module 0, as you face the PSU side of the chassis.

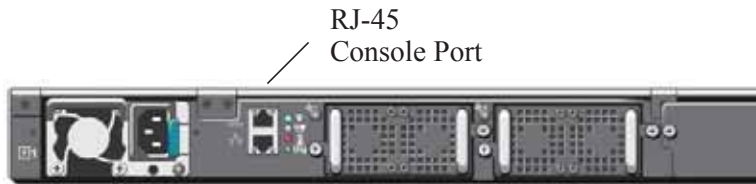

To access the console port, follow the procedures below. Refer to [Table 3-1, "Pin Assignments Between the Console and a DTE Terminal Server,"](#) in [Getting Started](#) for the console port pinout.

| Step | Task |
|------|--|
| 1 | Install an RJ-45 copper cable into the console port. Use a rollover (crossover) cable to connect the S4810 or S4820T console port to a terminal server. |
| 2 | Connect the other end of the cable to the DTE terminal server. |
| 3 | Terminal settings on the console port cannot be changed in the software and are set as follows: 9600 baud rate No parity 8 data bits 1 stop bit No flow control |

Accessing the RJ-45 console port with a DB-9 adapter

You can connect to the console using a RJ-45 to RJ-45 rollover cable and a RJ-45 to DB-9 female DTE adapter to a terminal server (for example, PC). [Table 3-1, "Pin Assignments Between the Console and a DTE Terminal Server,"](#) in [Getting Started](#) lists the pin assignments.

Table 3-1. Pin Assignments Between the Console and a DTE Terminal Server

| S-Series Console Port | RJ-45 to RJ-45 Rollover Cable | | RJ-45 to DB-9 Adapter | Terminal Server Device |
|-----------------------|-------------------------------|--------------|-----------------------|------------------------|
| | RJ-45 pinout | RJ-45 Pinout | DB-9 Pin | Signal |
| RTS | 1 | 8 | 8 | CTS |
| NC | 2 | 7 | 6 | DSR |
| TxD | 3 | 6 | 2 | RxD |
| GND | 4 | 5 | 5 | GND |
| GND | 5 | 4 | 5 | GND |
| RxD | 6 | 3 | 3 | TxD |

Table 3-1. Pin Assignments Between the Console and a DTE Terminal Server (continued)

| S-Series Console Port | RJ-45 to RJ-45 Rollover Cable | | RJ-45 to DB-9 Adapter | Terminal Server Device |
|-----------------------|-------------------------------|--------------|-----------------------|------------------------|
| Signal | RJ-45 pinout | RJ-45 Pinout | DB-9 Pin | Signal |
| NC | 7 | 2 | 4 | DTR |
| CTS | 8 | 1 | 7 | RTS |

Default Configuration

A version of FTOS is pre-loaded onto the chassis, however the system is not configured when you power up for the first time (except for the default hostname, which is FTOS). You must configure the system using the CLI.

Configure a Host Name

The host name appears in the prompt. The default host name is FTOS.

- Host names must start with a letter and end with a letter or digit.
- Characters within the string can be letters, digits, and hyphens.

To configure a host name:

| Step | Task | Command Syntax | Command Mode |
|------|-------------------------|-----------------------------------|---------------|
| 1 | Create a new host name. | <code>hostname <i>name</i></code> | CONFIGURATION |

The example below illustrates the hostname command.

```
FTOS (conf) #hostname R1
R1 (conf) #
```

Access the System Remotely

You can configure the system to access it remotely by Telnet. The method for configuring the C-Series and E-Series for Telnet access is different from S-Series.

- The C-Series, E-Series, S4810 and the S4820T have a dedicated management port and a management routing table that is separate from the IP routing table.

- The S-Series (except the S4810 and S4820T) does not have a dedicated management port, but is managed from any port. It does not have a separate management routing table.

Access the C-Series, E-Series, S4810, and the S4820T Remotely

Configuring the system for Telnet is a three-step process:

1. Configure an IP address for the management port. See [Configure the Management Port IP Address](#).
2. Configure a management route with a default gateway. See [Configure a Management Route](#).
3. Configure a username and password. See [Configure a Username and Password](#).

Configure the Management Port IP Address

Assign IP addresses to the management ports in order to access the system remotely.



Note: Assign different IP addresses to each RPM's management port.

To configure the management port IP address:

| Step | Task | Command Syntax | Command Mode |
|------|---|---|---------------|
| 1 | Enter INTERFACE mode for the Management port. | interface ManagementEthernet <i>slot/port</i> <ul style="list-style-type: none"> • <i>slot</i> range: 0 to 1 • <i>port</i> range: 0 | CONFIGURATION |
| 2 | Assign an IP address to the interface. | ip address <i>ip-address/mask</i> <ul style="list-style-type: none"> • <i>ip-address</i>: an address in dotted-decimal format (A.B.C.D). • <i>mask</i>: a subnet mask in /prefix-length format (/xx). | INTERFACE |
| 3 | Enable the interface. | no shutdown | INTERFACE |

Configure a Management Route

Define a path from the system to the network from which you are accessing the system remotely. Management routes are separate from IP routes and are only used to manage the system through the management port.

To configure a management route:

| Step | Task | Command Syntax | Command Mode |
|------|--|--|---------------|
| 1 | Configure a management route to the network from which you are accessing the system. | management route <i>ip-address/mask gateway</i> <ul style="list-style-type: none"><i>ip-address</i>: the network address in dotted-decimal format (A.B.C.D).<i>mask</i>: a subnet mask in /prefix-length format (/xx).<i>gateway</i>: the next hop for network traffic originating from the management port. | CONFIGURATION |

Configure a Username and Password

Configure a system username and password to access the system remotely.

To configure a username and password:

| Step | Task | Command Syntax | Command Mode |
|------|--|---|---------------|
| 1 | Configure a username and password to access the system remotely. | username <i>username</i> password [<i>encryption-type</i>] <i>password</i> <i>encryption-type</i> specifies how you are inputting the password, is 0 by default, and is not required. <ul style="list-style-type: none">0 is for inputting the password in clear text.7 is for inputting a password that is already encrypted using a Type 7 hash. Obtaining the encrypted password from the configuration of another Dell Force10 system. | CONFIGURATION |

Access the S-Series Remotely

The S-Series does not have a dedicated management port nor a separate management routing table. Configure any port on the S-Series to be the port through which you manage the system and configure an IP route to that gateway.



Note: The S4810 and S4820T systems use management ports and should be configured similar to the C-Series and E-Series systems. Refer to [Access the C-Series, E-Series, S4810, and the S4820T Remotely](#)

Configuring the system for Telnet access is a three-step process:

1. Configure an IP address for the port through which you will manage the system using the command `ip address` from INTERFACE mode, as shown in the example below.
2. Configure a IP route with a default gateway using the command `ip route` from CONFIGURATION mode, as shown in the example below.

- Configure a username and password using the command `username` from CONFIGURATION mode, as shown in the example below.

```
R5(conf)#int gig 0/48
R5(conf-if-gi-0/48)#ip address 10.11.131.240
R5(conf-if-gi-0/48)#show config
!
interface GigabitEthernet 0/48
 ip address 10.11.131.240/24
 no shutdown
R5(conf-if-gi-0/48)#exit
R5(conf)#ip route 10.11.32.0/23 10.11.131.254
R5(conf)#username admin pass FTOS
```

Configure the Enable Password

Access the EXEC Privilege mode using the `enable` command. The EXEC Privilege mode is unrestricted by default. Configure a password as a basic security measure. There are two types of enable passwords:

- `enable password` stores the password in the running/startup configuration using a DES encryption method.
- `enable secret` is stored in the running/startup configuration in using a stronger, MD5 encryption method.

Dell Force10 recommends using the `enable secret` password.

To configure an enable password:

| Task | Command Syntax | Command Mode |
|--|--|---------------|
| Create a password to access EXEC Privilege mode. | <pre>enable [password secret] [level <i>level</i>] [encryption-type] password</pre> <p><i>level</i> is the privilege level, is 15 by default, and is not required.</p> <p><i>encryption-type</i> specifies how you are inputting the password, is 0 by default, and is not required.</p> <ul style="list-style-type: none"> 0 is for inputting the password in clear text. 7 is for inputting a password that is already encrypted using a DES hash. Obtain the encrypted password from the configuration file of another Dell Force10 system. 5 is for inputting a password that is already encrypted using an MD5 hash. Obtain the encrypted password from the configuration file of another Dell Force10 system. | CONFIGURATION |

Configuration File Management

Files can be stored on and accessed from various storage media. Rename, delete, and copy files on the system from the EXEC Privilege mode.

The E-Series EtherScale platform architecture uses MMC cards for both the internal and external Flash memory. MMC cards support a maximum of 100 files. The E-Series TeraScale and ExaScale platforms architecture use Compact Flash for the internal and external Flash memory. It has a space limitation but does not limit the number of files it can contain.

 **Note:** Using flash memory cards in the system that have not been approved by Dell Force10 can cause unexpected system behavior, including a reboot.

Copy Files to and from the System

The command syntax for copying files is similar to UNIX. The copy command uses the format `copy source-file-url destination-file-url`.

 **Note:** See the *FTOS Command Reference* for a detailed description of the copy command.

- To copy a local file to a remote system, combine the *file-origin* syntax for a local file location with the *file-destination* syntax for a remote file location shown in [Table 3-2, "Forming a copy Command," in Getting Started](#).
- To copy a remote file to Dell Force10 system, combine the *file-origin* syntax for a remote file location with the *file-destination* syntax for a local file location shown in [Table 3-2, "Forming a copy Command," in Getting Started](#).

Table 3-2. Forming a copy Command

| | <i>source-file-url</i> Syntax | <i>destination-file-url</i> Syntax |
|--------------------------------------|--|---------------------------------------|
| Local File Location | | |
| Internal flash: | | |
| primary RPM | <code>copy flash://filename</code> | <code>flash://filename</code> |
| standby RPM | <code>copy rpm{0 1}flash://filename</code> | <code>rpm{0 1}flash://filename</code> |
| External flash: | | |
| primary RPM | <code>copy rpm{0 1}slot0://filename</code> | <code>rpm{0 1}slot0://filename</code> |
| standby RPM | <code>copy rpm{0 1}slot0://filename</code> | <code>rpm{0 1}slot0://filename</code> |
| USB Drive (E-Series ExaScale) | | |
| USB drive on RPM0 | <code>copy rpm0usbflash://filepath</code> | <code>rpm0usbflash://filename</code> |
| External USB drive | <code>copy usbflash://filepath</code> | <code>usbflash://filename</code> |

Table 3-2. Forming a copy Command (continued)

| | <i>source-file-url Syntax</i> | <i>destination-file-url Syntax</i> |
|-----------------------------|--|---|
| Remote File Location | | |
| FTP server | copy ftp://username:password@{hostip hostname}/filepath/filename | ftp://username:password@{hostip hostname}/filepath/filename |
| TFTP server | copy tftp://{hostip hostname}/filepath/filename | tftp://{hostip hostname}/filepath/filename |
| SCP server | copy scp://{hostip hostname}/filepath/filename | scp://{hostip hostname}/filepath/filename |

Important Points to Remember

- You may not copy a file from one remote system to another.
- You may not copy a file from one location to the same location.
- The internal flash memories on the RPMs are synchronized whenever there is a change, but only if both RPMs are running the same version of FTOS.
- When copying to a server, a hostname can only be used if a DNS server is configured.
- The `usbflash` and `rpm0usbflash` commands are supported on E-Series ExaScale systems. Refer to your system's Release Notes for a list of approved USB vendors.

The following text is an example of using the copy command to save a file to an FTP server.

```
FTOS#copy flash://FTOS-EF-8.2.1.0.bin ftp://myusername:mypassword@10.10.10.10/
/FTOS/FTOS-EF-8.2.1.0
!!!!!!!!!!!!!!!!!!!!!!!!!!!!!!!!!!!!!!!!!!!!!!!!!!!!!!!!!!!!!!!!!!!!!!!!!!!!
27952672 bytes successfully copied
```

The following text is an example of using the copy command to import a file to the Dell Force10 system from an FTP server.

```
core1#$//copy ftp://myusername:mypassword@10.10.10.10//FTOS/
FTOS-EF-8.2.1.0.bin flash://
Destination file name [FTOS-EF-8.2.1.0.bin.bin]:
!!!!!!!!!!!!!!!!!!!!!!!!!!!!!!!!!!!!!!!!!!!!!!!!!!!!!!!!!!!!!!!!!!!!!!!!!!!!
26292881 bytes successfully copied
```

Save the Running-configuration

The running-configuration contains the current system configuration. Dell Force10 recommends that you copy your running-configuration to the startup-configuration. The system uses the startup-configuration during boot-up to configure the system. The startup-configuration is stored in the internal flash on the primary RPM by default, but it can be saved onto an external flash (on an RPM) or a remote server.

To save the running-configuration:



Note: The commands in this section follow the same format as those in [Copy Files to and from the System in the Getting Started chapter](#) but use the filenames *startup-configuration* and *running-configuration*. These commands assume that current directory is the internal flash, which is the system default.

| Task | Command Syntax | Command Mode |
|---|--|----------------|
| Save the running-configuration to: | | |
| the startup-configuration on the internal flash of the primary RPM | <code>copy running-config startup-config</code> | |
| the internal flash on an RPM | <code>copy running-config rpm{0 1}flash://filename</code> | |
| <p>Note: The internal flash memories on the RPMs are synchronized whenever there is a change, but only if the RPMs are running the same version of FTOS.</p> | | |
| the external flash of an RPM | <code>copy running-config rpm{0 1}slot0://filename</code> | EXEC Privilege |
| an FTP server | <code>copy running-config ftp://username:password@{hostip hostname}/filepath/filename</code> | |
| a TFTP server | <code>copy running-config tftp://{hostip hostname}/filepath/filename</code> | |
| an SCP server | <code>copy running-config scp://{hostip hostname}/filepath/filename</code> | |
| <p>Note: When copying to a server, a hostname can only be used if a DNS server is configured.</p> | | |
| Save the running-configuration to the startup-configuration on the internal flash of the primary RPM. Then copy the new startup-config file to the external flash of the primary RPM. | <code>copy running-config startup-config duplicate</code> | EXEC Privilege |

FTOS Behavior: If you create a startup-configuration on an RPM and then move the RPM to another chassis, the startup-configuration is stored as a backup file (with the extension *.bak*), and a new, empty startup-configuration file is created. To restore your original startup-configuration in this situation, overwrite the new startup-configuration with the original one using the command `copy startup-config.bak startup-config`.

Configure the Overload bit for Startup Scenario

For information on setting the router overload bit for a specific period of time after a switch reload is implemented, see the *FTOS Command Line Reference Guide*, Chapter 18 - Intermediate System to Intermediate System (IS-IS).

View Files

File information and content can only be viewed on local file systems. To view a list of files on the internal or external Flash:

| Step | Task | Command Syntax | Command Mode |
|------|------------------------------|----------------|----------------|
| 1 | View a list of files on: | | |
| | the internal flash of an RPM | dir flash: | EXEC Privilege |
| | the external flash of an RPM | dir slot: | |

The output of the command `dir` also shows the read/write privileges, size (in bytes), and date of modification for each file, as shown in the example below.

```
FTOS#dir
Directory of flash:

 1 drw-      32768   Jan 01 1980 00:00:00  .
 2 drwx         512   Jul 23 2007 00:38:44  ..
 3 drw-      8192   Mar 30 1919 10:31:04  TRACE_LOG_DIR
 4 drw-      8192   Mar 30 1919 10:31:04  CRASH_LOG_DIR
 5 drw-      8192   Mar 30 1919 10:31:04  NVTRACE_LOG_DIR
 6 drw-      8192   Mar 30 1919 10:31:04  CORE_DUMP_DIR
 7 d---      8192   Mar 30 1919 10:31:04  ADMIN_DIR
 8 -rw-    33059550   Jul 11 2007 17:49:46  FTOS-EF-7.4.2.0.bin
 9 -rw-    27674906   Jul 06 2007 00:20:24  FTOS-EF-4.7.4.302.bin
10 -rw-    27674906   Jul 06 2007 19:54:52  boot-image-FILE
11 drw-      8192   Jan 01 1980 00:18:28  diag
12 -rw-      7276   Jul 20 2007 01:52:40  startup-config.bak
13 -rw-      7341   Jul 20 2007 15:34:46  startup-config
14 -rw-    27674906   Jul 06 2007 19:52:22  boot-image
15 -rw-    27674906   Jul 06 2007 02:23:22  boot-flash
--More--
```

To view the directories on a flash drive residing in the S4820T's USB (Type-A) port, use the **usbflash** parameter, as in the following example:

```
FTOS#dir usbflash:
Directory of usbflash:

 1 drwx      4096   Jan 01 1980 00:00:00 +00:00  .
 2 drwx      2048   Dec 01 2010 22:11:27 +00:00  ..
 3 -rwx    21814334   Oct 05 2012 21:35:56 +00:00  s55_usb
15 -rw-    30661593   Oct 05 2012 08:01:42 +00:00  file
16 -rwx      524528   Oct 28 2010 23:27:34 +00:00
s4820t_uboot_FTOSBOOT-SE-1-0-0-31_recent
19 -rwx      8053   Dec 01 2010 23:00:22 +00:00  running-config
20 -rwx    28615614   Oct 05 2012 08:08:32 +00:00  s4820t-FTOS5-SE-1-0-0-26
21 -rwx 1000000000   Oct 05 2012 10:07:32 +00:00  s4820junk
```

```

22 -rwx 30659825 Oct 05 2012 10:32:54 +00:00 1
23 -rwx 28615614 Oct 05 2012 08:58:26 +00:00 file1
24 -rwx 30659825 Oct 05 2012 10:32:30 +00:00 file2
25 -rwx 1000000000 Oct 05 2012 10:14:30 +00:00 s4820junk1
26 -rwx 1000000000 Oct 05 2012 10:18:26 +00:00 s4820junk2
27 -rwx 28615614 Oct 05 2012 10:30:06 +00:00 s4820t-FTOS5-SE-1-0-0-26file
30 -rwx 28615614 Oct 05 2012 10:31:36 +00:00 s4820t-FTOS5-SE-1-0-0-26file1
34 -rwx 30659825 Oct 05 2012 10:33:02 +00:00 2
35 -rwx 30659825 Oct 05 2012 10:33:08 +00:00 3
36 -rwx 30659825 Oct 05 2012 10:33:26 +00:00 4
37 -rwx 16644007 Oct 05 2012 11:22:56 +00:00 file19
39 -rwx 130000 Oct 05 2012 11:27:20 +00:00 junkfile1
usbflash: 4040642560 bytes total (151228416 bytes free)

```

To view the contents of a file:

| Step | Task | Command Syntax | Command Mode |
|------|--|------------------------------------|----------------|
| 1 | View the: | | |
| | contents of a file in the internal flash of an RPM | show file rpm{0 1}flash://filename | |
| | contents of a file in the external flash of an RPM | show file rpm{0 1}slot0://filename | EXEC Privilege |
| | running-configuration | show running-config | |
| | startup-configuration | show startup-config | |

View Configuration Files

Configuration files have three commented lines at the beginning of the file, as shown in the example below, to help you track the last time any user made a change to the file, which user made the changes, and when the file was last saved to the startup-configuration.

In the running-configuration file, if there is a difference between the timestamp on the “Last configuration change,” and “Startup-config last updated,” then you have made changes that have not been saved and will not be preserved upon a system reboot.

```

FTOS#show running-config
Current Configuration ...
! Version 8.2.1.0
! Last configuration change at Thu Apr 3 23:06:28 2008 by admin
! Startup-config last updated at Thu Apr 3 23:06:55 2008 by admin
!
boot system rpm0 primary flash://FTOS-EF-8.2.1.0.bin
boot system rpm0 secondary flash://FTOS-EF-7.8.1.0.bin
boot system rpm0 default flash://FTOS-EF-7.7.1.1.bin
boot system rpm1 primary flash://FTOS-EF-7.8.1.0.bin
boot system gateway 10.10.10.100

```

--More--

An example of accessing the running configuration file on an external flash drive inserted into the S4820T's USB port:

```
FTOS#show file-systems
```

| Size (b) | Free (b) | Feature | Type | Flags | Prefixes |
|------------|------------|---------|-----------|-------|-----------|
| 2056916992 | 1774563328 | FAT32 | USERFLASH | rw | flash: |
| 4040642560 | 151228416 | FAT32 | USBFLASH | rw | usbflash: |
| - | - | - | network | rw | ftp: |
| - | - | - | network | rw | tftp: |
| - | - | - | network | rw | scp: |

File System Management

The Dell Force10 system can use the internal Flash, external Flash, or remote devices to store files. It stores files on the internal Flash by default but can be configured to store files elsewhere.

To view file system information:

| Task | Command Syntax | Command Mode |
|--|-------------------|----------------|
| View information about each file system. | show file-systems | EXEC Privilege |

The output of the command show file-systems in the example below shows the total capacity, amount of free memory, file structure, media type, read/write privileges for each storage device in use.

```
FTOS#show file-systems
```

| Size (b) | Free (b) | Feature | Type | Flags | Prefixes |
|-----------|-----------|----------|-----------|-------|----------|
| 520962048 | 213778432 | dosFs2.0 | USERFLASH | rw | flash: |
| 127772672 | 21936128 | dosFs2.0 | USERFLASH | rw | slot0: |
| - | - | - | network | rw | ftp: |
| - | - | - | network | rw | tftp: |
| - | - | - | network | rw | scp: |

You can change the default file system so that file management commands apply to a particular device or memory.

To change the default storage location:

| Task | Command Syntax | Command Mode |
|-------------------------------|---------------------|----------------|
| Change the default directory. | cd <i>directory</i> | EXEC Privilege |

In the example below, the default storage location is changed to the external Flash of the primary RPM. File management commands then apply to the external Flash rather than the internal Flash.

```

FTOS#cd slot0:
FTOS#copy running-config test
FTOS#copy run test
!
7419 bytes successfully copied
FTOS#dir
Directory of slot0:

 1  drw-      32768   Jan 01 1980 00:00:00  .
 2  drwx       512   Jul 23 2007 00:38:44  ..
 3  ----         0   Jan 01 1970 00:00:00  DCIM
 4  -rw-      7419   Jul 23 2007 20:44:40  test
 5  ----         0   Jan 01 1970 00:00:00  BT
 6  ----         0   Jan 01 1970 00:00:00  200702~1VSN
 7  ----         0   Jan 01 1970 00:00:00  G
 8  ----         0   Jan 01 1970 00:00:00  F
 9  ----         0   Jan 01 1970 00:00:00  F

```

```
slot0: 127772672 bytes total (21927936 bytes free)
```

View command history

The command-history trace feature captures all commands entered by all users of the system with a time stamp and writes these messages to a dedicated trace log buffer. The system generates a trace message for each executed command. No password information is saved to the file.

To view the command-history trace, use the `show command-history` command, as shown in the example below.

```

FTOS#show command-history
[12/5 10:57:8]: CMD-(CLI):service password-encryption
[12/5 10:57:12]: CMD-(CLI):hostname Force10
[12/5 10:57:12]: CMD-(CLI):ip telnet server enable
[12/5 10:57:12]: CMD-(CLI):line console 0
[12/5 10:57:12]: CMD-(CLI):line vty 0 9
[12/5 10:57:13]: CMD-(CLI):boot system rpm0 primary flash://FTOS-CB-1.1.1.2E2.bin

```

Upgrading FTOS



Note: To upgrade FTOS, see the release notes for the version you want to load on the system.

Management

Management is supported on platforms: e C S **S4810** **S4820T**

This chapter explains the different protocols or services used to manage the Dell Force10 system including:

- [Configure Privilege Levels](#)
- [Configure Logging](#)
- [File Transfer Services](#)
- [Terminal Lines](#)
- [Lock CONFIGURATION mode](#)
- [Recovering from a Forgotten Password on the S4810 or S4820T](#)
- [Recovering from a Failed Start on the S4810 or S4820T](#)

Configure Privilege Levels

Privilege levels restrict access to commands based on user or terminal line. There are 16 privilege levels, of which three are pre-defined. The default privilege level is 1.

- **Level 0**—Access to the system begins at EXEC mode, and EXEC mode commands are limited to enable, disable, and exit.
- **Level 1**—Access to the system begins at EXEC mode, and all commands are available.
- **Level 15**—Access to the system begins at EXEC Privilege mode, and all commands are available.

Create a Custom Privilege Level

Custom privilege levels start with the default EXEC mode command set. You can then customize privilege levels 2-14 by:

- restricting access to an EXEC mode command
- moving commands from EXEC Privilege to EXEC mode
- restricting access

A user can access all commands at his privilege level and below.

Removing a command from EXEC mode

Remove a command from the list of available commands in EXEC mode for a specific privilege level using the command `privilege exec` from CONFIGURATION mode. In the command, specify a level *greater* than the level given to a user or terminal line, followed by the first keyword of each command to be restricted.

Move a command from EXEC privilege mode to EXEC mode

Move a command from EXEC Privilege to EXEC mode for a privilege level using the command `privilege exec` from CONFIGURATION mode. In the command, specify the privilege level of the user or terminal line, and specify *all* keywords in the command to which you want to allow access.

Allow Access to CONFIGURATION mode commands

Allow access to CONFIGURATION mode using the command `privilege exec level level configure` from CONFIGURATION mode. A user that enters CONFIGURATION mode remains at his privilege level, and has access to only two commands, `end` and `exit`. You must individually specify each CONFIGURATION mode command to which you want to allow access using the command `privilege configure level level`. In the command, specify the privilege level of the user or terminal line, and specify *all* keywords in the command to which you want to allow access.

Allow Access to INTERFACE, LINE, ROUTE-MAP, and ROUTER mode

1. Similar to allowing access to CONFIGURATION mode, to allow access to INTERFACE, LINE, ROUTE-MAP, and ROUTER modes, you must first allow access to the command that enters you into the mode. For example, allow a user to enter INTERFACE mode using the command `privilege configure level level interface gigabitethernet`
2. Then, individually identify the INTERFACE, LINE, ROUTE-MAP or ROUTER commands to which you want to allow access using the command `privilege {interface | line | route-map | router} level level`. In the command, specify the privilege level of the user or terminal line, and specify *all* keywords in the command to which you want to allow access.

The following table lists the configuration tasks you can use to customize a privilege level:

| Task | Command Syntax | Command Mode |
|--|---|---------------|
| Remove a command from the list of available commands in EXEC mode. | <code>privilege exec level level {command ... command}</code> | CONFIGURATION |
| Move a command from EXEC Privilege to EXEC mode. | <code>privilege exec level level {command ... command}</code> | CONFIGURATION |
| Allow access to CONFIGURATION mode. | <code>privilege exec level level configure</code> | CONFIGURATION |

| Task | Command Syntax | Command Mode |
|---|---|---------------|
| Allow access to INTERFACE, LINE, ROUTE-MAP, and/or ROUTER mode. Specify <i>all</i> keywords in the command. | privilege configure level <i>level</i> {interface line route-map router} { <i>command-keyword</i> ... <i>command-keyword</i> } | CONFIGURATION |
| Allow access to a CONFIGURATION, INTERFACE, LINE, ROUTE-MAP, and/or ROUTER mode command. | privilege {configure interface line route-map router} level <i>level</i> { <i>command</i> ... <i>command</i> } | CONFIGURATION |

The configuration in the following example creates privilege level 3. This level:

- removes the resequence command from EXEC mode by requiring a minimum of privilege level 4
- moves the command capture bgp-pdu max-buffer-size from EXEC Privilege to EXEC mode by requiring a minimum privilege level 3, which is the configured level for VTY 0
- allows access to CONFIGURATION mode with the banner command
- allows access to INTERFACE and LINE modes are allowed with no commands

```

FTOS(conf)#do show run priv
!
privilege exec level 3 capture
privilege exec level 3 configure
privilege exec level 4 resequence
privilege exec level 3 capture bgp-pdu
privilege exec level 3 capture bgp-pdu max-buffer-size
privilege configure level 3 line
privilege configure level 3 interface
FTOS(conf)#do telnet 10.11.80.201
[telnet output omitted]
FTOS#show priv
Current privilege level is 3.
FTOS#?
capture                Capture packet
configure              Configuring from terminal
disable               Turn off privileged commands
enable                Turn on privileged commands
exit                  Exit from the EXEC
ip                    Global IP subcommands
monitor               Monitoring feature
mtrace                Trace reverse multicast path from destination to source
ping                  Send echo messages
quit                  Exit from the EXEC
show                  Show running system information
[output omitted]
FTOS#config
[output omitted]
FTOS(conf)#do show priv
Current privilege level is 3.
FTOS(conf)#?

```

```

end                               Exit from configuration mode
exit                               Exit from configuration mode
interface                          Select an interface to configure
line                                Configure a terminal line
linecard                            Set line card type
FTOS(conf)#interface ?
fastethernet                       Fast Ethernet interface
gigabitethernet                    Gigabit Ethernet interface
loopback                            Loopback interface
managementethernet                 Management Ethernet interface
null                                 Null interface
port-channel                        Port-channel interface
range                               Configure interface range
tengigabitethernet                 TenGigabit Ethernet interface
vlan                                VLAN interface
FTOS(conf)#interface gigabitethernet 1/1
FTOS(conf-if-gi-1/1)#?
end                                 Exit from configuration mode
exit                               Exit from interface configuration mode
FTOS(conf-if-gi-1/1)#exit
FTOS(conf)#line ?
aux                                  Auxiliary line
console                             Primary terminal line
vty                                  Virtual terminal
FTOS(conf)#line vty 0
FTOS(config-line-vty)#?
exit                                Exit from line configuration mode
FTOS(config-line-vty)#

```

Apply a Privilege Level to a Username

To set a privilege level for a user:

| Task | Command Syntax | Command Mode |
|---|--|---------------|
| Configure a privilege level for a user. | <code>username <i>username</i> privilege <i>level</i></code> | CONFIGURATION |

Apply a Privilege Level to a Terminal Line

To set a privilege level for a terminal line:

| Task | Command Syntax | Command Mode |
|--|---|--------------|
| Configure a privilege level for a terminal line. | <code>privilege level <i>level</i></code> | LINE |



Note: When you assign a privilege level between 2 and 15, access to the system begins at EXEC mode, but the prompt is `hostname#`, rather than `hostname>`.

Configure Logging

FTOS tracks changes in the system using event and error messages. By default, FTOS logs these messages on:

- the internal buffer
- console and terminal lines, and
- any configured syslog servers

Disable Logging

To disable logging:

| Task | Command Syntax | Command Mode |
|--|--------------------|---------------|
| Disable all logging except on the console. | no logging on | CONFIGURATION |
| Disable logging to the logging buffer. | no logging buffer | CONFIGURATION |
| Disable logging to terminal lines. | no logging monitor | CONFIGURATION |
| Disable console logging. | no logging console | CONFIGURATION |

Log Messages in the Internal Buffer

All error messages, except those beginning with %BOOTUP (Message), are log in the internal buffer.

Message 1 BootUp Events

```
%BOOTUP:RPM0:CP %PORTPIPE-INIT-SUCCESS: Portpipe 0 enabled
```

Configuration Task List for System Log Management

The following list includes the configuration tasks for system log management:

- [Disable System Logging](#)
- [Send System Messages to a Syslog Server](#)

Disable System Logging

By default, logging is enabled and log messages are sent to the logging buffer, all terminal lines, console, and syslog servers.

Enable and disable system logging using the following commands:

| Task | Command Syntax | Command Mode |
|--|--------------------|---------------|
| Disable all logging except on the console. | no logging on | CONFIGURATION |
| Disable logging to the logging buffer. | no logging buffer | CONFIGURATION |
| Disable logging to terminal lines. | no logging monitor | CONFIGURATION |
| Disable console logging. | no logging console | CONFIGURATION |

Send System Messages to a Syslog Server

Send system messages to a syslog server by specifying the server with the following command:

| Task | Command Syntax | Command Mode |
|---|---|---------------|
| Specify the server to which you want to send system messages. You can configure up to eight syslog servers. | logging { <i>ip-address</i> <i>hostname</i> } | CONFIGURATION |

Configure a Unix System as a Syslog Server

Configure a UNIX system as a syslog server by adding the following lines to */etc/syslog.conf* on the Unix system and assigning write permissions to the file.

- on a 4.1 BSD UNIX system, add the line: `local7.debugging /var/log/ftos.log`
- on a 5.7 SunOS UNIX system, add the line: `local7.debugging /var/adm/ftos.log`

In the lines above, `local7` is the logging facility level and `debugging` is the severity level.

Change System Logging Settings

You can change the default settings of the system logging by changing the severity level and the storage location. The default is to log all messages up to debug level, that is, all system messages. By changing the severity level in the logging commands, you control the number of system messages logged.

| Task | Command Syntax | Command Mode |
|---|-------------------------------|---------------|
| Specify the minimum severity level for logging to the logging buffer. | logging buffered <i>level</i> | CONFIGURATION |
| Specify the minimum severity level for logging to the console. | logging console <i>level</i> | CONFIGURATION |
| Specify the minimum severity level for logging to terminal lines. | logging monitor <i>level</i> | CONFIGURATION |

| Task | Command Syntax | Command Mode |
|---|---|---------------|
| Specifying the minimum severity level for logging to a syslog server. | <code>logging trap <i>level</i></code> | CONFIGURATION |
| Specify the minimum severity level for logging to the syslog history table. | <code>logging history <i>level</i></code> | CONFIGURATION |

| Task | Command Syntax | Command Mode |
|---|---|---------------|
| Specify the size of the logging buffer. Note: When you decrease the buffer size, FTOS deletes all messages stored in the buffer. Increasing the buffer size does not affect messages in the buffer. | <code>logging buffered <i>size</i></code> | CONFIGURATION |
| Specify the number of messages that FTOS saves to its logging history table. | <code>logging history size <i>size</i></code> | CONFIGURATION |

To change one of the settings for logging system messages, use any or all of the following commands in the CONFIGURATION mode:

To view the logging buffer and configuration, use the `show logging` command in the EXEC privilege mode as shown in the example for [Display the Logging Buffer and the Logging Configuration](#).

To change the severity level of messages logged to a syslog server, use the following command in the CONFIGURATION mode:

To view the logging configuration, use the `show running-config logging` command in the EXEC privilege mode as shown in the example for [Configure a UNIX logging facility level](#).

Display the Logging Buffer and the Logging Configuration

Display the current contents of the logging buffer and the logging settings for the system, use the `show logging` command in the EXEC privilege mode as shown in the example below.

```
FTOS#show logging
syslog logging: enabled
  Console logging: level Debugging
  Monitor logging: level Debugging
  Buffer logging: level Debugging, 40 Messages Logged, Size (40960 bytes)
  Trap logging: level Informational
%IRC-6-IRC_COMMUP: Link to peer RPM is up
%RAM-6-RAM_TASK: RPM1 is transitioning to Primary RPM.
%RPM-2-MSG:CP1 %POLLMGR-2-MMC_STATE: External flash disk missing in 'slot0:'
%CHMGR-5-CARDDETECTED: Line card 0 present
%CHMGR-5-CARDDETECTED: Line card 2 present
%CHMGR-5-CARDDETECTED: Line card 4 present
%CHMGR-5-CARDDETECTED: Line card 5 present
```

```

%CHMGR-5-CARDDETECTED: Line card 8 present
%CHMGR-5-CARDDETECTED: Line card 10 present
%CHMGR-5-CARDDETECTED: Line card 12 present
%TSM-6-SFM_DISCOVERY: Found SFM 0
%TSM-6-SFM_DISCOVERY: Found SFM 1
%TSM-6-SFM_DISCOVERY: Found SFM 2
%TSM-6-SFM_DISCOVERY: Found SFM 3
%TSM-6-SFM_DISCOVERY: Found SFM 4
%TSM-6-SFM_DISCOVERY: Found SFM 5
%TSM-6-SFM_DISCOVERY: Found SFM 6
%TSM-6-SFM_DISCOVERY: Found SFM 7
%TSM-6-SFM_SWITCHFAB_STATE: Switch Fabric: UP
%TSM-6-SFM_DISCOVERY: Found SFM 8
%TSM-6-SFM_DISCOVERY: Found 9 SFMs
%CHMGR-5-CHECKIN: Checkin from line card 5 (type EX1YB, 1 ports)
%TSM-6-PORT_CONFIG: Port link status for LC 5 => portpipe 0: OK portpipe 1: N/A
%CHMGR-5-LINECARDUP: Line card 5 is up
%CHMGR-5-CHECKIN: Checkin from line card 12 (type S12YC12, 12 ports)
%TSM-6-PORT_CONFIG: Port link status for LC 12 => portpipe 0: OK portpipe 1: N/A
%CHMGR-5-LINECARDUP: Line card 12 is up
%IFMGR-5-CSTATE_UP: changed interface Physical state to up: So 12/8
%IFMGR-5-CSTATE_DN: changed interface Physical state to down: So 12/8

```

To view any changes made, use the **show running-config** logging command in the EXEC privilege mode as shown in the example for [Configure a UNIX logging facility level](#).

Configure a UNIX logging facility level

You can save system log messages with a UNIX system logging facility.

To configure a UNIX logging facility level, use the following command in the CONFIGURATION mode:

| Command Syntax | Command Mode | Purpose |
|---|---------------|---|
| logging facility [<i>facility-type</i>] | CONFIGURATION | Specify one of the following parameters. <ul style="list-style-type: none">• auth (for authorization messages)• cron (for system scheduler messages)• daemon (for system daemons)• kern (for kernel messages)• local0 (for local use)• local1 (for local use)• local2 (for local use)• local3 (for local use)• local4 (for local use)• local5 (for local use)• local6 (for local use)• local7 (for local use). This is the default.• lpr (for line printer system messages)• mail (for mail system messages)• news (for USENET news messages)• sys9 (system use)• sys10 (system use)• sys11 (system use)• sys12 (system use)• sys13 (system use)• sys14 (system use)• syslog (for syslog messages)• user (for user programs)• uucp (UNIX to UNIX copy protocol) The default is local7. |

To view nondefault settings, use the **show running-config logging** command in the EXEC mode as shown in the example below.

```
FTOS#show running-config logging
!
logging buffered 524288 debugging
service timestamps log datetime msec
service timestamps debug datetime msec
!
logging trap debugging
logging facility user
logging source-interface Loopback 0
logging 10.10.10.4
FTOS#
```

Synchronize log messages

You can configure FTOS to filter and consolidate the system messages for a specific line by synchronizing the message output. Only the messages with a severity at or below the set level appear. This feature works on the terminal and console connections available on the system.

To synchronize log messages, use these commands in the following sequence starting in the CONFIGURATION mode:

| Step | Command Syntax | Command Mode | Purpose |
|------|---|---------------|---|
| 1 | line {console 0 vty <i>number</i> [<i>end-number</i>] aux 0} | CONFIGURATION | Enter the LINE mode. Configure the following parameters for the virtual terminal lines: <ul style="list-style-type: none"> <i>number</i> range: zero (0) to 8. <i>end-number</i> range: 1 to 8. You can configure multiple virtual terminals at one time by entering a <i>number</i> and an <i>end-number</i> . |
| 2 | logging synchronous [level <i>severity-level</i> all] [<i>limit</i>] | LINE | Configure a level and set the maximum number of messages to be printed. Configure the following optional parameters: <ul style="list-style-type: none"> level <i>severity-level</i> range: 0 to 7. Default is 2. Use the all keyword to include all messages. <i>limit</i> range: 20 to 300. Default is 20. |

To view the logging synchronous configuration, use the **show config** command in the LINE mode.

Enable timestamp on syslog messages

By default, syslog messages do not include a time/date stamp stating when the error or message was created.

To have FTOS include a timestamp with the syslog message, use the following command syntax in the CONFIGURATION mode:

| Command Syntax | Command Mode | Purpose |
|--|---------------|--|
| service timestamps [log debug] [datetime [localtime] [msec] [show-timezone] uptime] | CONFIGURATION | Add timestamp to syslog messages. Specify the following optional parameters: <ul style="list-style-type: none"> datetime: You can add the keyword localtime to include the localtime, msec, and show-timezone. If you do not add the keyword localtime, the time is UTC. uptime. To view time since last boot. If neither parameter is specified, FTOS configures uptime . |

To view the configuration, use the **show running-config logging** command in the EXEC privilege mode.

To disable time stamping on syslog messages, enter **no service timestamps [log | debug]**.

File Transfer Services

With FTOS, you can configure the system to transfer files over the network using File Transfer Protocol (FTP). One FTP application is copying the system image files over an interface on to the system; however, FTP is not supported on VLAN interfaces.

For more information on FTP, refer to [RFC 959, File Transfer Protocol](#).



Note: To transmit large files, Dell Force10 recommends configuring the switch as an FTP server.

Configuration Task List for File Transfer Services

The following list includes the configuration tasks for file transfer services:

- [Enable FTP server](#) (mandatory)
- [Configure FTP server parameters](#) (optional)
- [Configure FTP client parameters](#) (optional)

Enable FTP server

To enable the system as an FTP server, use the following command in the CONFIGURATION mode:

| Command Syntax | Command Mode | Purpose |
|-------------------|---------------|---------------------------|
| ftp-server enable | CONFIGURATION | Enable FTP on the system. |

To view FTP configuration, use the `show running-config ftp` command in the EXEC privilege mode as shown in the example below.

```
FTOS#show running ftp
!  
ftp-server enable  
ftp-server username nairobi password 0 zanzibar  
FTOS#
```

Configure FTP server parameters

After the FTP server is enabled on the system, you can configure different parameters.

To configure FTP server parameters, use any or all of the following commands in the CONFIGURATION mode:

| Command Syntax | Command Mode | Purpose |
|---|---------------|---|
| ftp-server topdir <i>dir</i> | CONFIGURATION | Specify the directory for users using FTP to reach the system. The default is the internal flash directory. |
| ftp-server username <i>username</i> password [<i>encryption-type</i>] <i>password</i> | CONFIGURATION | Specify a user name for all FTP users and configure either a plain text or encrypted password. Configure the following optional and required parameters: <ul style="list-style-type: none"> <i>username</i>: Enter a text string <i>encryption-type</i>: Enter 0 for plain text or 7 for encrypted text. <i>password</i>: Enter a text string. |



Note: You cannot use the **change directory (cd)** command until **ftp-server topdir** has been configured.

To view the FTP configuration, use the **show running-config ftp** command in EXEC privilege mode.

Configure FTP client parameters

To configure FTP client parameters, use the following commands in the CONFIGURATION mode:

| Command Syntax | Command Mode | Purpose |
|--|---------------|---|
| ip ftp source-interface <i>interface</i> | CONFIGURATION | Enter the following keywords and slot/port or number information: <ul style="list-style-type: none"> For a Gigabit Ethernet interface, enter the keyword GigabitEthernet followed by the slot/port information. For a loopback interface, enter the keyword loopback followed by a number between 0 and 16383. For a port channel interface, enter the keyword port-channel followed by a number from 1 to 255 for TeraScale and ExaScale, 1 to 32 for EtherScale. For a SONET interface, enter the keyword sonet followed by the slot/port information. For a 10-Gigabit Ethernet interface, enter the keyword TenGigabitEthernet followed by the slot/port information. For a VLAN interface, enter the keyword vlan followed by a number from 1 to 4094. For a 40-Gigabit Ethernet interface, enter the keyword fortyGigE followed by the slot/port information. |
| ip ftp password <i>password</i> | CONFIGURATION | Configure a password. |
| ip ftp username <i>name</i> | CONFIGURATION | Enter username to use on FTP client. |

To view FTP configuration, use the **show running-config ftp** command in the EXEC privilege mode as shown in the example for [Enable FTP server](#).

Terminal Lines

You can access the system remotely and restrict access to the system by creating user profiles. The terminal lines on the system provide different means of accessing the system. The console line (console) connects you through the Console port in the RPMs. The virtual terminal lines (VTY) connect you through Telnet to the system. The auxiliary line (aux) connects secondary devices such as modems.

Deny and Permit Access to a Terminal Line

Dell Force10 recommends applying only standard ACLs to deny and permit access to VTY lines.

- Layer 3 ACL deny all traffic that is not explicitly permitted, but in the case of VTY lines, an ACL with no rules does not deny any traffic.
- You cannot use `show ip accounting access-list` to display the contents of an ACL that is applied only to a VTY line.

To apply an IP ACL to a line:

| Task | Command Syntax | Command Mode |
|-----------------------------|---|--------------|
| Apply an ACL to a VTY line. | <code>ip access-class <i>access-list</i></code> | LINE |

To view the configuration, enter the `show config` command in the LINE mode, as shown in the example below.

```
FTOS(config-std-nacl)#show config
!
ip access-list standard myvtyacl
 seq 5 permit host 10.11.0.1
FTOS(config-std-nacl)#line vty 0
FTOS(config-line-vty)#show config
line vty 0
 access-class myvtyacl
```

FTOS Behavior: Prior to FTOS version 7.4.2.0, in order to deny access on a VTY line, you must apply an ACL and AAA authentication to the line. Then users are denied access only *after* they enter a username and password. Beginning in FTOS version 7.4.2.0, only an ACL is required, and users are denied access *before* they are prompted for a username and password.

Configure Login Authentication for Terminal Lines

You can use any combination of up to 6 authentication methods to authenticate a user on a terminal line. A combination of authentication methods is called a method list. If the user fails the first authentication method, FTOS prompts the next method until all methods are exhausted, at which point the connection is terminated. The available authentication methods are:

- **enable**—Prompt for the enable password.
- **line**—Prompt for the e password you assigned to the terminal line. You must configure a password for the terminal line to which you assign a method list that contains the line authentication method. Configure a password using the command `password` from LINE mode.
- **local**—Prompt for the system username and password.
- **none**—Do not authenticate the user.
- **radius**—Prompt for a username and password and use a RADIUS server to authenticate.
- **tacacs+**—Prompt for a username and password and use a TACACS+ server to authenticate.

To configure authentication for a terminal line:

| Step | Task | Command Syntax | Command Mode |
|------|--|--|---------------|
| 1 | Create an authentication method list. You may use a mnemonic name or use the keyword <code>default</code> . The default authentication method for terminal lines is <code>local</code> , and the default method list is empty. | <code>aaa authentication login {method-list-name default} [method-1] [method-2] [method-3] [method-4] [method-5] [method-6]</code> | CONFIGURATION |
| 2 | Apply the method list from Step 1 to a terminal line. | <code>login authentication {method-list-name default}</code> | CONFIGURATION |
| 3 | If you used the line authentication method in the method list you applied to the terminal line, configure a password for the terminal line. | <code>password</code> | LINE |

In the example below, VTY lines 0-2 use a single authentication method, `line`.

```
FTOS(conf)#aaa authentication login myvtymethodlist line
FTOS(conf)#line vty 0 2
FTOS(config-line-vty)#login authentication myvtymethodlist
FTOS(config-line-vty)#password myvtypassword
FTOS(config-line-vty)#show config
line vty 0
  password myvtypassword
  login authentication myvtymethodlist
line vty 1
  password myvtypassword
  login authentication myvtymethodlist
line vty 2
  password myvtypassword
  login authentication myvtymethodlist
FTOS(config-line-vty)#
```

Time out of EXEC Privilege Mode

EXEC timeout is a basic security feature that returns FTOS to the EXEC mode after a period of inactivity on terminal lines.

To change the timeout period or disable EXEC timeout.

| Task | Command Syntax | Command Mode |
|--|---|--------------|
| Set the number of minutes and seconds. Default: 10 minutes on console, 30 minutes on VTY. Disable EXEC timeout by setting the timeout period to 0. | <code>exec-timeout <i>minutes</i> [<i>seconds</i>]</code> | LINE |
| Return to the default timeout values. | <code>no exec-timeout</code> | LINE |

View the configuration using the command `show config` from LINE mode.

```
FTOS(conf)#line con 0
FTOS(config-line-console)#exec-timeout 0
FTOS(config-line-console)#show config
line console 0
  exec-timeout 0 0
FTOS(config-line-console)#
```

Telnet to Another Network Device

To telnet to another device:

| Task | Command Syntax | Command Mode |
|---|---|----------------|
| Telnet to the peer RPM. You do not need to configure the management port on the peer RPM to be able to telnet to it. | <code>telnet-peer-rpm</code> | EXEC Privilege |
| Telnet to a device with an IPv4 or IPv6 address. If you do not enter an IP address, FTOS enters a Telnet dialog that prompts you for one. <ul style="list-style-type: none">Enter an IPv4 address in dotted decimal format (A.B.C.D).Enter an IPv6 address in the format 0000:0000:0000:0000:0000:0000:0000:0000. Elision of zeros is supported. | <code>telnet [<i>ip-address</i>]</code> | EXEC Privilege |

```
FTOS# telnet 10.11.80.203
Trying 10.11.80.203...
Connected to 10.11.80.203.
Exit character is '^]'.
Login:
Login: admin
Password:
FTOS>exit
```

```

FTOS#telnet 2200:2200:2200:2200:2200::2201
Trying 2200:2200:2200:2200:2200::2201...
Connected to 2200:2200:2200:2200:2200::2201.
Exit character is '^]'.
FreeBSD/i386 (freebsd2.force10networks.com) (ttyp1)
login: admin
FTOS#

```

Lock CONFIGURATION mode

FTOS allows multiple users to make configurations at the same time. You can lock CONFIGURATION mode so that only one user can be in CONFIGURATION mode at any time ([Message 2](#)).

A two types of locks can be set: auto and manual.

- Set an auto-lock using the command `configuration mode exclusive auto` from CONFIGURATION mode. When you set an auto-lock, every time a user is in CONFIGURATION mode all other users are denied access. This means that you can exit to EXEC Privilege mode, and re-enter CONFIGURATION mode without having to set the lock again.
- Set a manual lock using the command `configure terminal lock` from CONFIGURATION mode. When you configure a manual lock, which is the default, you must enter this command time you want to enter CONFIGURATION mode and deny access to others.

```

FTOS(conf)#configuration mode exclusive auto
BATMAN(conf)#exit
3d23h35m: %RPM0-P:CP %SYS-5-CONFIG_I: Configured from console by console

```

```

FTOS#config
! Locks configuration mode exclusively.
FTOS(conf)#

```

If another user attempts to enter CONFIGURATION mode while a lock is in place, [Message 1](#) appears on their terminal.

Message 1 CONFIGURATION mode Locked Error

```
% Error: User "" on line console0 is in exclusive configuration mode
```

If *any* user is already in CONFIGURATION mode when while a lock is in place, [Message 2](#) appears on their terminal.

Message 2 Cannot Lock CONFIGURATION mode Error

```

% Error: Can't lock configuration mode exclusively since the following users are
currently configuring the system:
User "admin" on line vty1 ( 10.1.1.1 )

```



Note: The CONFIGURATION mode lock corresponds to a VTY session, not a user. Therefore, if you configure a lock and then exit CONFIGURATION mode, and another user enters CONFIGURATION mode, when you attempt to re-enter CONFIGURATION mode, you are denied access even though you are the one that configured the lock.



Note: If your session times out and you return to EXEC mode, the CONFIGURATION mode lock is unconfigured.

Viewing the Configuration Lock Status

If you attempt to enter CONFIGURATION mode when another user has locked it, you may view which user has control of CONFIGURATION mode using the command `show configuration lock` from EXEC Privilege mode.

You can then send any user a message using the `send` command from EXEC Privilege mode. Alternatively you can clear any line using the command `clear` from EXEC Privilege mode. If you clear a console session, the user is returned to EXEC mode.

Recovering from a Forgotten Password on the S4810 or S4820T

If you configure authentication for the console and you exit out of EXEC mode or your console session times out, you are prompted for a password to re-enter.

If you forget your password:

| Step | Task | Command Syntax | Command Mode |
|------|--|---|-----------------|
| 1 | Log onto the system via console. | | |
| 2 | Power-cycle the chassis by switching off all of the power modules and then switching them back on. | | |
| 3 | Hit any key to abort the boot process. You enter uBoot i mme id at ely, as indicated by the => prompt. | hit any key | (during bootup) |
| 4 | Set the system parameters to ignore the startup configuration file when the system reloads. | setenv stconfigignore true | uBoot |
| 5 | To save the changes use the saveenv command. | saveenv | uBoot |
| 6 | Reload the system. | reset | uBoot |
| 7 | Copy startup-config.bak to the running config. | copy flash://startup-config.bak running-config | EXEC Privilege |

| Step | Task | Command Syntax | Command Mode |
|------|--|--|----------------|
| 8 | Remove all authentication statements you might have for the console. | no authentication login no password | LINE |
| 9 | Save the running-config. | copy running-config startup-config | EXEC Privilege |
| 10 | Set the system parameters to use the startup configuration file when the system reloads. | setenv stconfigignore false | uBoot |
| 11 | Save the running-config. | copy running-config startup-config | EXEC Privilege |

Recovering from a Forgotten Enable Password on the S4810 or S4820T

If you forget the enable password:

| Step | Task | Command Syntax | Command Mode |
|------|--|---|-----------------|
| 1 | Log onto the system via console. | | |
| 2 | Power-cycle the chassis by switching off all of the power modules and then switching them back on. | | |
| 3 | Hit any key to abort the boot process. You enter uBoot immediately, as indicated by the => prompt. | hit any key | (during bootup) |
| 4 | Set the system parameters to ignore the enable password when the system reloads. | setenv enablepwdignore true | uBoot |
| 5 | Reload the system. | reset | uBoot |
| 6 | Configure a new enable password. | enable {secret password} | CONFIGURATION |
| 7 | Save the running-config to the startup-config. | copy running-config startup-config | EXEC Privilege |

Recovering from a Failed Start on the S4810 or S4820T

A system that does not start correctly might be attempting to boot from a corrupted FTOS image or from a mis-specified location. In that case, you can restart the system and interrupt the boot process to point the system to another boot location. Use the `setenv` command, as described below. For details on the `setenv` command, its supporting commands, and other commands that can help recover from a failed start, see the Boot User chapter in the *FTOS Command Line Reference for the S4810 and S4820T*.

| Step | Task | Command Syntax | Command Mode |
|------|--|----------------|--------------|
| 1 | Power-cycle the chassis (pull the power cord and reinsert it). | | |

| Step | Task | Command Syntax | Command Mode |
|-------------|--|--|---------------------|
| 2 | Hit any key to abort the boot process. You enter uBoot immediately, as indicated by the => prompt. | hit any key | (during bootup) |
| 3 | Assign the new location to the FTOS image to be used when the system reloads. | setenv [primary_image f10boot <i>location</i> secondary_image f10boot <i>location</i> default_image f10boot <i>location</i>] | uBoot |
| 4 | Assign an IP address to the Management Ethernet interface. | setenv ipaddre <i>address</i> | uBoot |
| 5 | | | |
| 6 | Assign an IP address as the default gateway for the system. | setenv gatewayip <i>address</i> | uBoot |
| 7 | Reload the system. | reset | uBoot |

802.1ag

802.1ag is available only on platform: S **S4810** **S4820T**

Ethernet Operations, Administration, and Maintenance (OAM) is a set of tools used to install, monitor, troubleshoot and manage Ethernet infrastructure deployments. Ethernet OAM consists of three main areas:

1. Service Layer OAM: IEEE 802.1ag Connectivity Fault Management (CFM)
2. Link Layer OAM: IEEE 802.3ah OAM
3. Ethernet Local management Interface (MEF-16 E-LMI)

Ethernet CFM

Ethernet CFM is an end-to-end per-service-instance Ethernet OAM scheme which enables: proactive connectivity monitoring, fault verification, and fault isolation.

The service-instance with regard to OAM for Metro/Carrier Ethernet is a VLAN. This service is sold to an end-customer by a network service provider. Typically the service provider contracts with multiple network operators to provide end-to-end service between customers. For end-to-end service between customer switches, connectivity must be present across the service provider through multiple network operators.

Layer 2 Ethernet networks usually cannot be managed with IP tools such as ICMP Ping and IP Traceroute. Traditional IP tools often fail because:

- there are complex interactions between various Layer 2 and Layer 3 protocols such as STP, LAG, VRRP and ECMP configurations.
- Ping and traceroute are not designed to verify data connectivity in the network and within each node in the network (such as in the switching fabric and hardware forwarding tables).
- when networks are built from different operational domains, access controls impose restrictions that cannot be overcome at the IP level, resulting in poor fault visibility. There is a need for hierarchical domains that can be monitored and maintained independently by each provider or operator.
- routing protocols choose a subset of the total network topology for forwarding, making it hard to detect faults in links and nodes that are not included in the active routing topology. This is made more complex when using some form of Traffic Engineering (TE) based routing.
- network and element discovery and cataloging is not clearly defined using IP troubleshooting tools.

There is a need for Layer 2 equivalents to manage and troubleshoot native Layer 2 Ethernet networks. With these tools, you can identify, isolate, and repair faults quickly and easily, which reduces operational cost of running the network. OAM also increases availability and reduces mean time to recovery, which allows for tighter service level agreements, resulting in increased revenue for the service provider.

In addition to providing end-to-end OAM in native Layer 2 Ethernet Service Provider/Metro networks, you can also use CFM to manage and troubleshoot any Layer 2 network including enterprise, datacenter, and cluster networks.

Maintenance Domains

Connectivity Fault Management (CFM) divides a network into hierarchical maintenance domains, as shown in the illustration below.

A CFM maintenance domain is a management space on a network that is owned and operated by a single management entity. The network administrator assigns a unique maintenance level (0 to 7) to each domain to define the hierarchical relationship between domains. Domains can touch or nest but cannot overlap or intersect as that would require management by multiple entities.

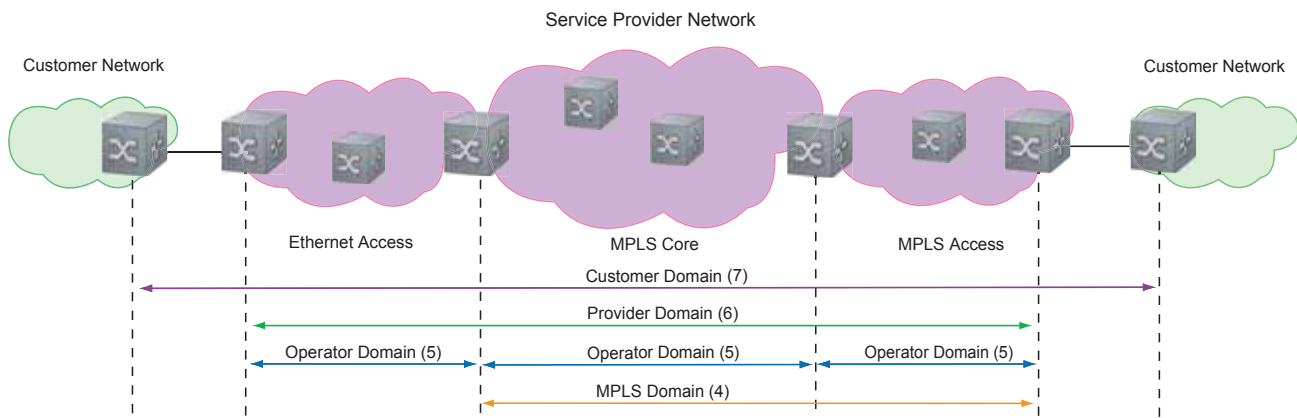

Maintenance Points

Domains are comprised of logical entities called Maintenance Points. A maintenance point is an interface demarcation that confines CFM frames to a domain. There are two types of maintenance points:

- **Maintenance End Points (MEPs):** a logical entity that marks the end-point of a domain
- **Maintenance Intermediate Points (MIPs):** a logical entity configured at a port of a switch that is an intermediate point of a Maintenance Entity (ME). An ME is a point-to-point relationship between two MEPs within a single domain. MIPs are internal to a domain, not at the boundary, and respond to CFM only when triggered by linktrace and loopback messages. MIPs can be configured to snoop Continuity Check Messages (CCMs) to build a MIP CCM database.

These roles define the relationships between all devices so that each device can monitor the layers under its responsibility. Maintenance points drop all lower-level frames and forward all higher-level frames.

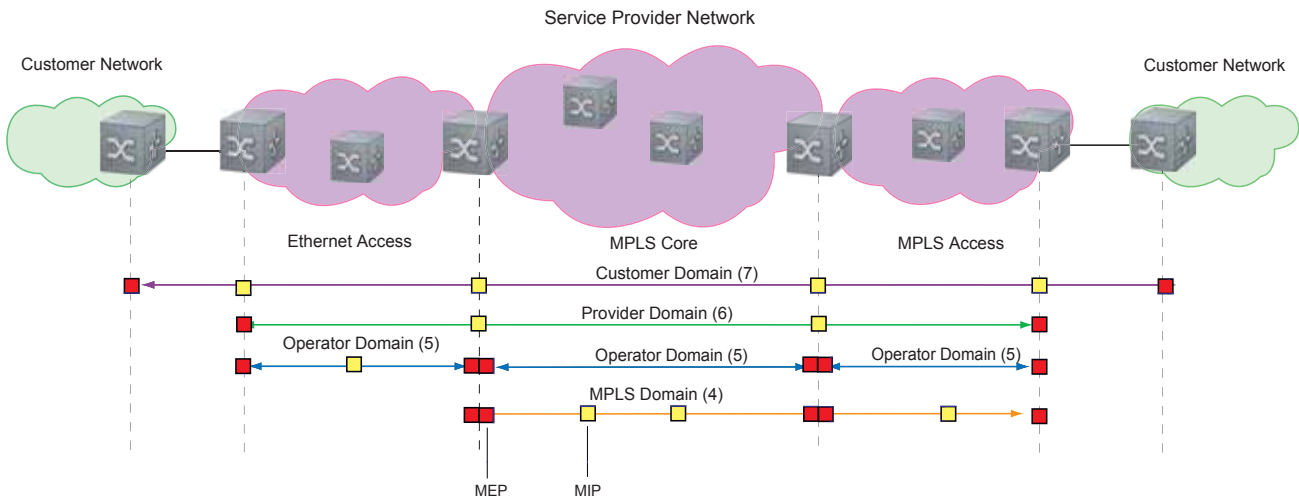

Maintenance End Points

A Maintenance End Point (MEP) is a logical entity that marks the end-point of a domain. There are two types of MEPs defined in 802.1ag for an 802.1 bridge:

- **Up-MEP:** monitors the forwarding path internal to an bridge on the customer or provider edge; on Dell Force10 systems the internal forwarding path is effectively the switch fabric and forwarding engine.
- **Down-MEP:** monitors the forwarding path external another bridge.

Configure Up- MEPs on ingress ports, ports that send traffic towards the bridge relay. Configure Down-MEPs on egress ports, ports that send traffic away from the bridge relay.

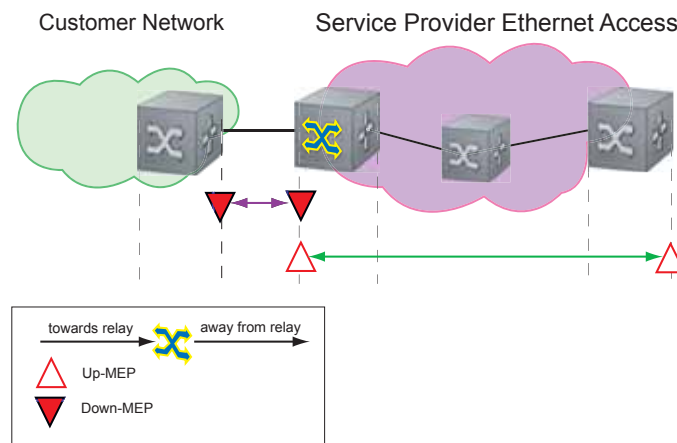

Implementation Information

- Since the S-Series has a single MAC address for all physical/LAG interfaces, only one MEP is allowed per MA (per VLAN or per MD level).

Configure CFM

Configuring CFM is a five-step process:

1. Configure the ecfmacl CAM region using the cam-acl command. Refer to [Configure Ingress Layer 2 ACL Sub-partitions](#).
2. Enable Ethernet CFM.
3. Create a Maintenance Domain.
4. Create a Maintenance Association.
5. Create Maintenance Points.
6. Use CFM tools:
 - a. Continuity Check Messages
 - b. Loopback Message and Response
 - c. Linktrace Message and Response

Related Configuration Tasks

- [Enable CFM SNMP Traps](#).
- [Display Ethernet CFM Statistics](#)

Enable Ethernet CFM

| Task | Command Syntax | Command Mode |
|--|----------------|---------------|
| Spawn the CFM process. No CFM configuration is allowed until the CFM process is spawned. | ethernet cfm | CONFIGURATION |
| Disable Ethernet CFM without stopping the CFM process. | disable | ETHERNET CFM |

Create a Maintenance Domain

Connectivity Fault Management (CFM) divides a network into hierarchical maintenance domains, as shown in the illustration in [Maintenance Domains](#).

| Step | Task | Command Syntax | Command Mode |
|------|---|---|----------------|
| 1 | Create maintenance domain. | domain <i>name</i> md-level <i>number</i> Range: 0-7 | ETHERNET CFM |
| 2 | Display maintenance domain information. | show ethernet cfm domain [<i>name</i> brief] | EXEC Privilege |

```

FTOS# show ethernet cfm domain

Domain Name: customer
Level: 7
Total Service: 1
  Services
    MA-Name      VLAN      CC-Int      X-CHK Status
    My_MA        200       10s         enabled

Domain Name: praveen
Level: 6
Total Service: 1
  Services
    MA-Name      VLAN      CC-Int      X-CHK Status
    Your_MA      100       10s         enabled

```

Create a Maintenance Association

A Maintenance Association MA is a subdivision of an MD that contains all managed entities corresponding to a single end-to-end service, typically a VLAN. An MA is associated with a VLAN ID.

| Task | Command Syntax | Command Mode |
|---------------------------------|---|--------------|
| Create maintenance association. | service <i>name</i> vlan <i>vlan-id</i> | ECFM DOMAIN |

Create Maintenance Points

Domains are comprised of logical entities called Maintenance Points. A maintenance point is a interface demarcation that confines CFM frames to a domain. There are two types of maintenance points:

- **Maintenance End Points (MEPs):** a logical entity that marks the end-point of a domain
- **Maintenance Intermediate Points (MIPs):** a logical entity configured at a port of a switch that constitutes intermediate points of an Maintenance Entity (ME). An ME is a point-to-point relationship between two MEPs within a single domain.

These roles define the relationships between all devices so that each device can monitor the layers under its responsibility.

Create a Maintenance End Point

A Maintenance End Point (MEP) is a logical entity that marks the end-point of a domain. There are two types of MEPs defined in 802.1ag for an 802.1 bridge:

- **Up-MEP:** monitors the forwarding path internal to an bridge on the customer or provider edge; on Dell Force10 systems the internal forwarding path is effectively the switch fabric and forwarding engine.
- **Down-MEP:** monitors the forwarding path external another bridge.

Configure Up- MEPs on ingress ports, ports that send traffic towards the bridge relay. Configure Down-MEPs on egress ports, ports that send traffic away from the bridge relay.

| Task | Command Syntax | Command Mode |
|-----------------------------------|---|----------------|
| Create an MEP. | ethernet cfm mep {up-mep down-mep} domain { <i>name</i> <i>level</i> } ma-name <i>name</i> mepid <i>mep-id</i> Range: 1-8191 | INTERFACE |
| Display configured MEPs and MIPs. | show ethernet cfm maintenance-points local [<i>mep</i> <i>mip</i>] | EXEC Privilege |

| Task | Command Syntax | | | | | Command Mode |
|------|---|---------------|-------------|------------------------------|------------|--------------|
| | FTOS#show ethernet cfm maintenance-points local mep | | | | | |
| | ----- | | | | | |
| MPID | Domain Name MA Name | Level VLAN | Type Dir | Port MAC | CCM-Status | |
| | ----- | | | | | |
| 100 | cfm0 test0 | 7 10 | MEP DOWN | Gi 4/10 00:01:e8:59:23:45 | Enabled | |
| 200 | cfm1 test1 | 6 20 | MEP DOWN | Gi 4/10 00:01:e8:59:23:45 | Enabled | |
| 300 | cfm2 test2 | 5 30 | MEP DOWN | Gi 4/10 00:01:e8:59:23:45 | Enabled | |

Create a Maintenance Intermediate Point

Maintenance Intermediate Point (MIP) is a logical entity configured at a port of a switch that constitutes intermediate points of an Maintenance Entity (ME). An ME is a point-to-point relationship between two MEPs within a single domain. An MIP is not associated with any MA or service instance, and it belongs to the entire MD.

| Task | Command Syntax | Command Mode | | | | |
|-----------------------------------|--|----------------|-------------|-----------------------------|------------|--|
| Create an MIP. | ethernet cfm mip domain { <i>name</i> <i>level</i> } ma-name <i>name</i> | INTERFACE | | | | |
| Display configured MEPs and MIPs. | show ethernet cfm maintenance-points local [<i>mep</i> <i>mip</i>] | EXEC Privilege | | | | |
| | FTOS#show ethernet cfm maintenance-points local mip | | | | | |
| | ----- | | | | | |
| MPID | Domain Name MA Name | Level VLAN | Type Dir | Port MAC | CCM-Status | |
| | ----- | | | | | |
| 0 | service1 My_MA | 4 3333 | MIP DOWN | Gi 0/5 00:01:e8:0b:c6:36 | Disabled | |
| 0 | service1 Your_MA | 4 3333 | MIP UP | Gi 0/5 00:01:e8:0b:c6:36 | Disabled | |

MP Databases

CFM maintains two MP databases:

- **MEP Database (MEP-DB):** Every MEP must maintain a database of all other MEPs in the MA that have announced their presence via CCM.

- **MIP Database (MIP-DB):** Every MIP must maintain a database of all other MEPs in the MA that have announced their presence via CCM

| Task | Command Syntax | Command Mode |
|---|---|----------------|
| Display the MEP Database. | show ethernet cfm maintenance-points remote detail [active domain { <i>level</i> <i>name</i> } expired waiting] | EXEC Privilege |
| <pre>FTOS#show ethernet cfm maintenance-points remote detail MAC Address: 00:01:e8:58:68:78 Domain Name: cfm0 MA Name: test0 Level: 7 VLAN: 10 MP ID: 900 Sender Chassis ID: Force10 MEP Interface status: Up MEP Port status: Forwarding Receive RDI: FALSE MP Status: Active</pre> | | |
| Display the MIP Database. | show ethernet cfm mipdb | EXEC Privilege |

MP Database Persistence

| Task | Command Syntax | Command Mode |
|---|---|--------------|
| Set the amount of time that data from a missing MEP is kept in the Continuity Check Database. | database hold-time <i>minutes</i> Default: 100 minutes Range: 100-65535 minutes | ECFM DOMAIN |

Continuity Check Messages

Continuity Check Messages (CCM) are periodic hellos used to:

- discover MEPs and MIPs within a maintenance domain
- detect loss of connectivity between MEPs
- detect misconfiguration, such as VLAN ID mismatch between MEPs
- to detect unauthorized MEPs in a maintenance domain

Continuity Check Messages (CCM) are multicast Ethernet frames sent at regular intervals from each MEP. They have a destination address based on the MD level (01:80:C2:00:00:3X where X is the MD level of the transmitting MEP from 0 to 7). All MEPs must listen to these multicast MAC addresses and process these messages. MIPs may optionally process the CCM messages originated by MEPs and construct a MIP CCM database.

MEPs and MIPs filter CCMs from higher and lower domain levels as described in Table 5-1, "Continuity Check Message Processing," in 802.1ag.

Table 5-1. Continuity Check Message Processing

| Frames at | Frames from | UP-MEP Action | Down-MEP Action | MIP Action |
|-----------------------|--------------------------------|---------------|-----------------|---------------------------|
| Less than my level | Bridge-relay side or Wire side | Drop | Drop | Drop |
| My level | Bridge-relay side | Consume | Drop | Add to MIP-DB and forward |
| | Wire side | Drop | Consume | |
| Greater than my level | Bridge-relay side or Wire side | Forward | Forward | Forward |

All the remote MEPs in the maintenance domain are defined on each MEP. Each MEP then expects a periodic CCM from the configured list of MEPs. A connectivity failure is then defined as:

1. Loss of 3 consecutive CCMs from any of the remote MEP, which indicates a network failure
2. Reception of a CCM with an incorrect CCM transmission interval, which indicates a configuration error.
3. Reception of CCM with an incorrect MEP ID or MAID, which indicates a configuration or cross-connect error. This could happen when different VLANs are cross-connected due to a configuration error.
4. Reception of a CCM with an MD level lower than that of the receiving MEP, which indicates a configuration or cross-connect error.
5. Reception of a CCM containing a port status/interface status TLV, which indicates a failed bridge or aggregated port.

The Continuity Check protocol sends fault notifications (Syslogs, and SNMP traps if enabled) whenever any of the above errors are encountered.

Enable CCM

| Step | Task | Command Syntax | Command Mode |
|------|--|---|--------------|
| 1 | Enable CCM. | no ccm disable Default: Disabled | ECFM DOMAIN |
| 2 | Configure the transmit interval (mandatory). The interval specified applies to all MEPs in the domain. | ccm transmit-interval <i>seconds</i> Default: 10 seconds | ECFM DOMAIN |

Enable Cross-checking

| Task | Command Syntax | Command Mode |
|--|---|--------------|
| Enable cross-checking. | mep cross-check enable Default: Disabled | ETHERNET CFM |
| Start the cross-check operation for an MEP. | mep cross-check <i>mep-id</i> | ETHERNET CFM |
| Configure the amount of time the system waits for a remote MEP to come up before the cross-check operation is started. | mep cross-check start-delay <i>number</i> | ETHERNET CFM |

Loopback Message and Response

Loopback Message and Response (LBM, LBR), also called Layer 2 Ping, is an administrative echo transmitted by MEPs to verify reachability to another MEP or MIP within the maintenance domain. LBM and LBR are unicast frames.

| Task | Command Syntax | Command Mode |
|--------------------------|--|----------------|
| Send a Loopback message. | ping ethernet domain <i>name</i> ma-name <i>ma-name</i> remote { <i>mep-id</i> mac-addr <i>mac-address</i> } source { <i>mep-id</i> port <i>interface</i> } | EXEC Privilege |

Linktrace Message and Response

Linktrace Message and Response (LTM, LTR), also called Layer 2 Traceroute, is an administratively sent multicast frames transmitted by MEPs to track, hop-by-hop, the path to another MEP or MIP within the maintenance domain. All MEPs and MIPs in the same domain respond to an LTM with a unicast LTR. Intermediate MIPs forward the LTM toward the target MEP.

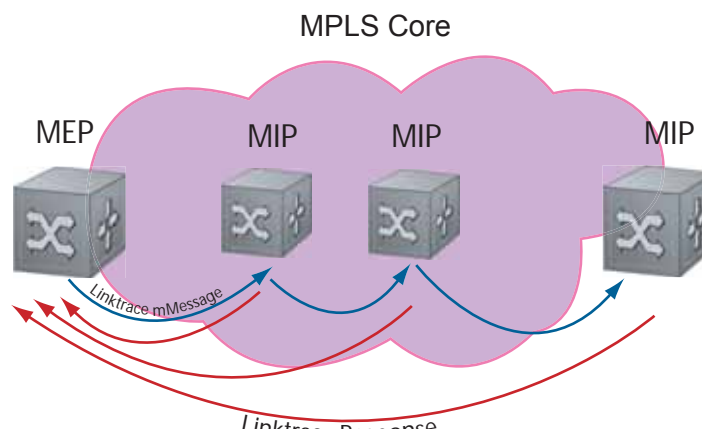

Link trace messages carry a unicast target address (the MAC address of an MIP or MEP) inside a multicast frame. The destination group address is based on the MD level of the transmitting MEP (01:80:C2:00:00:3[8 to F]). The MPs on the path to the target MAC address reply to the LTM with an LTR, and relays the LTM towards the target MAC until the target MAC is reached or TTL equals 0.

| Task | Command Syntax | Command Mode |
|--|---------------------------|----------------|
| Send a Linktrace message. Since the LTM is a Multicast message sent to the entire ME, there is no need to specify a destination. | tracertoe ethernet domain | EXEC Privilege |

Link Trace Cache

After a Link Trace command is executed, the trace information can be cached so that you can view it later without retracing.

| Task | Command Syntax | Command Mode | | | | | | | | | | |
|---|---|--------------------------|------------------------------|----------------------------|--------------------------|------------------------------|----------------------------|---|--|-------------------|-------|------------------------|
| Enable Link Trace caching. | tracertoe cache | CONFIGURATION | | | | | | | | | | |
| Set the amount of time a trace result is cached. | tracertoe cache hold-time <i>minutes</i> Default: 100 minutes Range: 10-65535 minutes | ETHERNET CFM | | | | | | | | | | |
| Set the size of the Link Trace Cache. | tracertoe cache size <i>entries</i> Default: 100 Range: 1 - 4095 entries | ETHERNET CFM | | | | | | | | | | |
| Display the Link Trace Cache. | show ethernet cfm tracertoe-cache | EXEC Privilege | | | | | | | | | | |
| <pre>FTOS#show ethernet cfm tracertoe-cache</pre> <p>Tracertoe to 00:01:e8:52:4a:f8 on Domain Customer2, Level 7, MA name Test2 with VLAN 2</p> <pre>-----</pre> <table border="1"> <thead> <tr> <th>Hops</th> <th>Host Next Host</th> <th>IngressMAC Egress MAC</th> <th>Ingr Action Egress Action</th> <th>Relay Action FWD Status</th> </tr> </thead> <tbody> <tr> <td>4</td> <td>00:00:00:01:e8:53:4a:f8 00:00:00:01:e8:52:4a:f8</td> <td>00:01:e8:52:4a:f8</td> <td>IngOK</td> <td>RlyHit Terminal MEP</td> </tr> </tbody> </table> <pre>-----</pre> | | | Hops | Host Next Host | IngressMAC Egress MAC | Ingr Action Egress Action | Relay Action FWD Status | 4 | 00:00:00:01:e8:53:4a:f8 00:00:00:01:e8:52:4a:f8 | 00:01:e8:52:4a:f8 | IngOK | RlyHit Terminal MEP |
| Hops | Host Next Host | IngressMAC Egress MAC | Ingr Action Egress Action | Relay Action FWD Status | | | | | | | | |
| 4 | 00:00:00:01:e8:53:4a:f8 00:00:00:01:e8:52:4a:f8 | 00:01:e8:52:4a:f8 | IngOK | RlyHit Terminal MEP | | | | | | | | |
| Delete all Link Trace Cache entries. | clear ethernet cfm tracertoe-cache | EXEC Privilege | | | | | | | | | | |

Enable CFM SNMP Traps.

| Task | Command Syntax | Command Mode |
|---|-------------------------------|---------------|
| Enable SNMP trap messages for Ethernet CFM. | snmp-server enable traps ecfm | CONFIGURATION |

A Trap is sent only when one of the five highest priority defects occur, as shown in [Table 5-2, "ECFM SNMP Traps,"](#) in 802.1ag.

Table 5-2. ECFM SNMP Traps

| | |
|----------------------|--|
| Cross-connect defect | %ECFM-5-ECFM_XCON_ALARM: Cross connect fault detected by MEP 1 in Domain customer1 at Level 7 VLAN 1000 |
| Error-CCM defect | %ECFM-5-ECFM_ERROR_ALARM: Error CCM Defect detected by MEP 1 in Domain customer1 at Level 7 VLAN 1000 |
| MAC Status defect | %ECFM-5-ECFM_MAC_STATUS_ALARM: MAC Status Defect detected by MEP 1 in Domain provider at Level 4 VLAN 3000 |
| Remote CCM defect | %ECFM-5-ECFM_REMOTE_ALARM: Remote CCM Defect detected by MEP 3 in Domain customer1 at Level 7 VLAN 1000 |
| RDI defect | %ECFM-5-ECFM_RDI_ALARM: RDI Defect detected by MEP 3 in Domain customer1 at Level 7 VLAN 1000 |

Three values are given within the trap messages: MD Index, MA Index, and MPID. You can reference these values against the output of `show ethernet cfm domain` and `show ethernet cfm maintenance-points local mep`.

```

FTOS#show ethernet cfm maintenance-points local mep
-----
MPID          Domain Name      Level  Type      Port      CCM-Status
              MA Name         VLAN  Dir       MAC
-----
100          cfm0             7     MEP       Gi 4/10   Enabled
              test0            10    DOWN     00:01:e8:59:23:45

FTOS(conf-if-gi-0/6)#do show ethernet cfm domain

Domain Name: My_Name
MD Index: 1
Level: 0
Total Service: 1
  Services
MA-Index      MA-Name         VLAN      CC-Int      X-CHK Status
-----
1             test             0         1s          enabled

Domain Name: Your_Name
MD Index: 2
Level: 2
Total Service: 1
  Services
MA-Index      MA-Name         VLAN      CC-Int      X-CHK Status
-----
1             test            100       1s          enabled

```

Display Ethernet CFM Statistics

| Task | Command Syntax | Command Mode |
|--|--|----------------|
| Display MEP CCM statistics. | show ethernet cfm statistics [domain { <i>name</i> <i>level</i> } vlan-id <i>vlan-id</i> mpid <i>mpid</i> | EXEC Privilege |
| <pre> FTOS# show ethernet cfm statistics Domain Name: Customer Domain Level: 7 MA Name: My_MA MPID: 300 CCMs: Transmitted: 1503 RcvdSeqErrors: 0 LTRs: Unexpected Rcvd: 0 LBRs: Received: 0 Rcvd Out Of Order: 0 Received Bad MSDU: 0 Transmitted: 0 </pre> | | |
| Display CFM statistics by port. | show ethernet cfm port-statistics [interface] | EXEC Privilege |
| <pre> FTOS#show ethernet cfm port-statistics interface gigabitethernet 0/5 Port statistics for port: Gi 0/5 ===== RX Statistics ===== Total CFM Pkts 75394 CCM Pkts 75394 LBM Pkts 0 LTM Pkts 0 LBR Pkts 0 LTR Pkts 0 Bad CFM Pkts 0 CFM Pkts Discarded 0 CFM Pkts forwarded 102417 TX Statistics ===== Total CFM Pkts 10303 CCM Pkts 0 LBM Pkts 0 LTM Pkts 3 LBR Pkts 0 LTR Pkts 0 </pre> | | |

802.1X

802.1X is supported on platforms: e C S **S4810** **S4820T**

Protocol Overview

802.1X is a method of port security. A device connected to a port that is enabled with 802.1X is disallowed from sending or receiving packets on the network until its identity can be verified (through a username and password, for example). This feature is named for its IEEE specification.

802.1X employs Extensible Authentication Protocol (EAP)* to transfer a device's credentials to an authentication server (typically RADIUS) via a mandatory intermediary network access device, in this case, a Dell Force10 switch. The network access device mediates all communication between the end-user device and the authentication server so that the network remains secure. The network access device uses EAP over Ethernet (EAPOL) to communicate with the end-user device and EAP over RADIUS to communicate with the server.

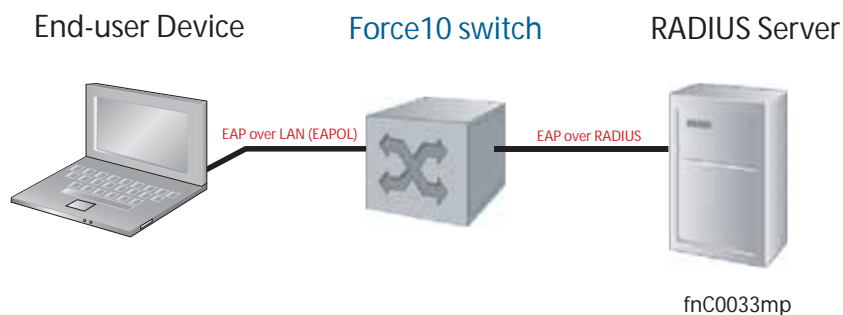
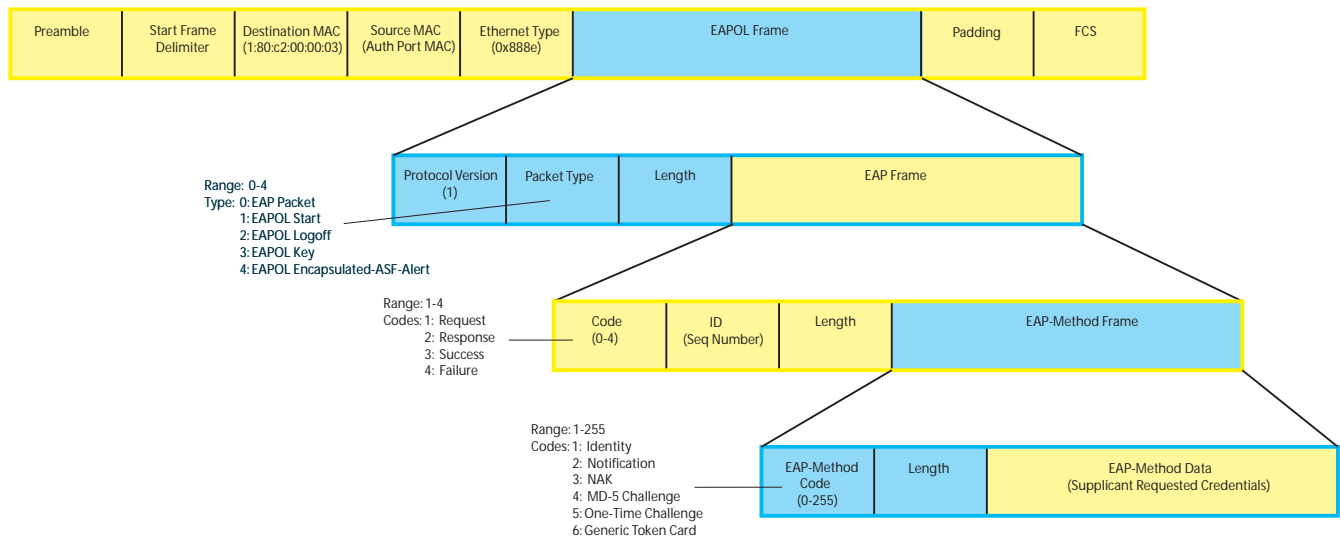

Figure 6-1 and Figure show how EAP frames are encapsulated in Ethernet and Radius frames.



Note: FTOS supports 802.1X with EAP-MD5, EAP-OTP, EAP-TLS, EAP-TTLS, PEAPv0, PEAPv1, and MS-CHAPv2 with PEAP.

Figure 6-1. EAPOL Frame Format

The authentication process involves three devices:

- The device attempting to access the network is the **supplicant**. The supplicant is not allowed to communicate on the network until the port is authorized by the authenticator. It can only communicate with the authenticator in response to 802.1X requests.
- The device with which the supplicant communicates is the **authenticator**. The authenticator is the gate keeper of the network. It translates and forwards requests and responses between the authentication server and the supplicant. The authenticator also changes the status of the port based on the results of the authentication process. The Dell Force10 switch is the authenticator.
- The **authentication-server** selects the authentication method, verifies the information provided by the supplicant, and grants it network access privileges.

Ports can be in one of two states:

- Ports are in an **unauthorized** state by default. In this state, non-802.1X traffic cannot be forwarded in or out of the port.
- The authenticator changes the port state to **authorized** if the server can authenticate the supplicant. In this state, network traffic can be forwarded normally.



Note: The Dell Force10 switches place 802.1X-enabled ports in the unauthorized state by default.

The Port-authentication Process

The authentication process begins when the authenticator senses that a link status has changed from down to up:

1. When the authenticator senses a link state change, it requests that the supplicant identify itself using an EAP Identity Request Frame.
2. The supplicant responds with its identity in an EAP Response Identity frame.

3. The authenticator decapsulates the EAP Response from the EAPOL frame, encapsulates it in a RADIUS Access-Request frame, and forwards the frame to the authentication server.
4. The authentication server replies with an Access-Challenge. The Access-Challenge is request that the supplicant prove that it is who it claims to be, using a specified method (an EAP-Method). The challenge is translated and forwarded to the supplicant by the authenticator.
5. The supplicant can negotiate the authentication method, but if it is acceptable, the supplicant provides the requested challenge information in an EAP Response, which is translated and forwarded to the authentication server as another Access-Request.
6. If the identity information provided by the supplicant is valid, the authentication server sends an Access-Accept frame in which network privileges are specified. The authenticator changes the port state to authorized, and forwards an EAP Success frame. If the identity information is invalid, the server sends and Access-Reject frame. The port state remains unauthorized, and the authenticator forwards EAP Failure frame.

Figure 6-2. 802.1X Authentication Process

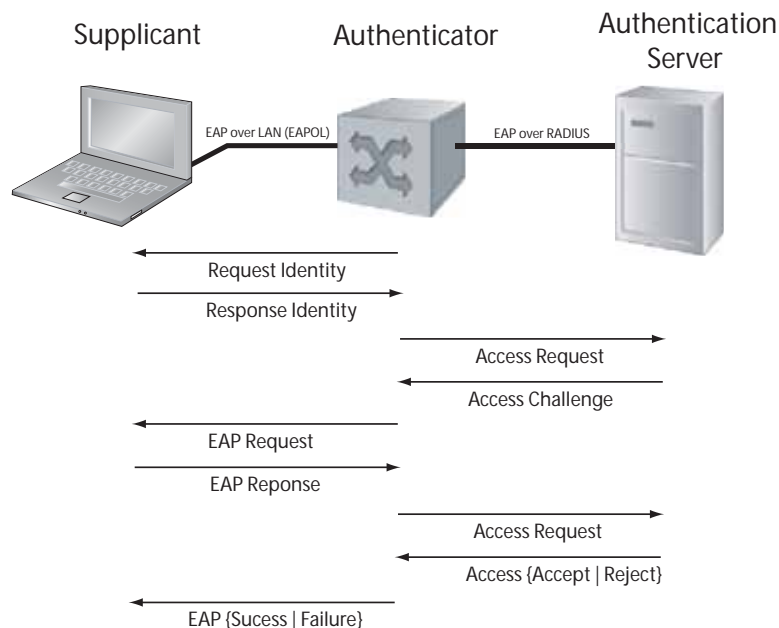

EAP over RADIUS

802.1X uses RADIUS to shuttle EAP packets between the authenticator and the authentication server, as defined in RFC 3579. EAP messages are encapsulated in RADIUS packets as a type of *attribute* in Type, Length, Value (TLV) format. The Type value for EAP messages is 79.

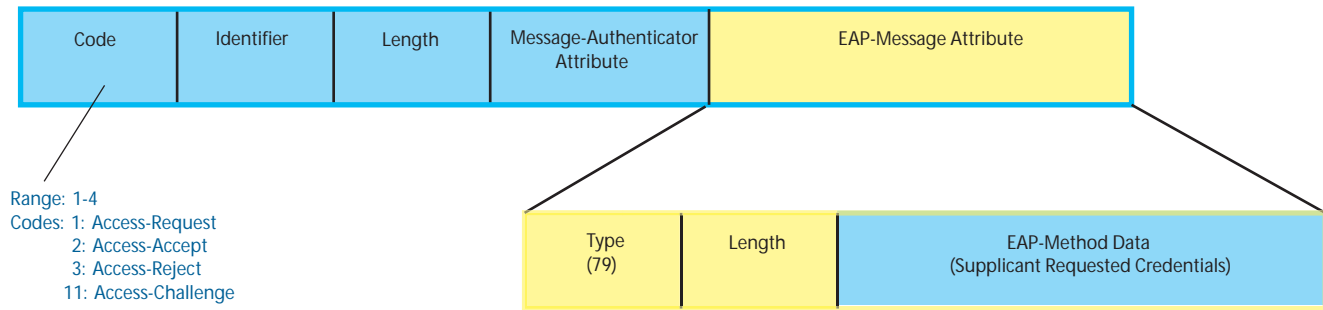
Figure 6-3. RADIUS Frame Format

fnC0034mp

RADIUS Attributes for 802.1 Support

Dell Force10 systems includes the following RADIUS attributes in all 802.1X-triggered Access-Request messages:

- **Attribute 5—NAS-Port:** the physical port number by which the authenticator is connected to the supplicant.
- **Attribute 31—Calling-station-id:** relays the supplicant MAC address to the authentication server.
- **Attribute 41—NAS-Port-Type:** NAS-port physical port type. 5 indicates Ethernet.
- **Attribute 81—Tunnel-Private-Group-ID:** associate a tunneled session with a particular group of users.

Configuring 802.1X

Configuring 802.1X on a port is a two-step process:

1. Enable 802.1X globally. See page 97.
2. Enable 802.1X on an interface. See page 97.

Related Configuration Tasks

- [Configuring Request Identity Re-transmissions on page 99](#)
- [Configuring Port-control on page 101](#)
- [Re-authenticating a Port on page 102](#)
- [Configuring Timeouts on page 103](#)
- [Configuring a Guest VLAN on page 106](#)
- [Configuring an Authentication-fail VLAN on page 106](#)

Important Points to Remember

- FTOS supports 802.1X with EAP-MD5, EAP-OTP, EAP-TLS, EAP-TTLS, PEAPv0, PEAPv1, and MS-CHAPv2 with PEAP.
- E-Series, C-Series, and S-Series support only RADIUS as the authentication server.
- 802.1X is not supported on port-channels or port-channel members.

Enabling 802.1X

802.1X must be enabled globally and at interface level.

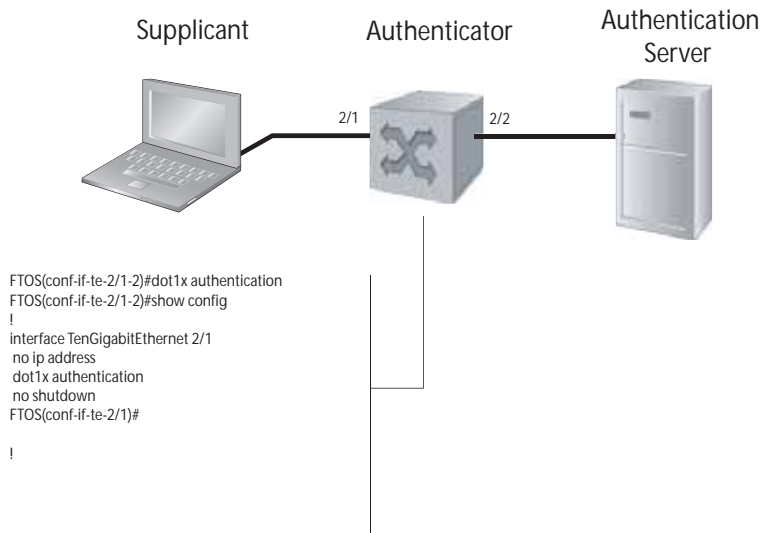
Figure 6-4. Enabling 802.1X

To enable 802.1X:

| Step | Task | Command Syntax | Command Mode |
|------|--|----------------------|---------------|
| 1 | Enable 802.1X globally. | dot1x authentication | CONFIGURATION |
| 2 | Enter INTERFACE mode on an interface or a range of interfaces. | interface [range] | INTERFACE |
| 3 | Enable 802.1X on an interface or a range of interfaces. | dot1x authentication | INTERFACE |

Verify that 802.1X is enabled globally and at interface level using the command `show running-config | find dot1x` from EXEC Privilege mode, as shown in [Figure 6-5](#).

Figure 6-5. Verifying 802.1X Global Configuration

```

FTOS#show running-config | find dot1x
dot1x authentication ← 802.1X Enabled
!
[output omitted]
!
interface GigabitEthernet 2/1
ip address 2.2.2.2/24
dot1x authentication ← 802.1X Enabled on
no shutdown
!
interface GigabitEthernet 2/2
ip address 1.0.0.1/24
dot1x authentication
no shutdown
--More--

```

View 802.1X configuration information for an interface using the command `show dot1x interface`, as shown in [Figure 6-6](#).

Figure 6-6. Verifying 802.1X Interface Configuration

```

FTOS#show dot1x interface gigabitethernet 2/1

802.1x information on Gi 2/1:
-----
Dot1x Status:      Enable
Port Control:     AUTO
Port Auth Status:  UNAUTHORIZED
Re-Authentication: Disable
Untagged VLAN id: None
Tx Period:        30 seconds
Quiet Period:     60 seconds
ReAuth Max:       2
Supplicant Timeout: 30 seconds
Server Timeout:   30 seconds
Re-Auth Interval: 3600 seconds
Max-EAP-Req:      2
Auth Type:        SINGLE_HOST

Auth PAE State:   Initialize
Backend State:    Initialize
    
```

802.1X Enabled on ←
All ports unauthorized by default ←

Configuring Request Identity Re-transmissions

If the authenticator sends a Request Identity frame, but the supplicant does not respond, the authenticator waits 30 seconds and then re-transmits the frame. The amount of time that the authenticator waits before re-transmitting and the maximum number of times that the authenticator re-transmits are configurable.

 **Note:** There are several reasons why the supplicant might fail to respond; the supplicant might have been booting when the request arrived, or there might be a physical layer problem.

To configure the amount of time that the authenticator waits before re-transmitting an EAP Request Identity frame:

| Step | Task | Command Syntax | Command Mode |
|------|---|---|--------------|
| 1 | Configure the amount of time that the authenticator waits before re-transmitting an EAP Request Identity frame. | dot1x tx-period <i>number</i> Range: 1-65535 (1 year) Default: 30 | INTERFACE |

To configure a maximum number of Request Identity re-transmissions:

| Step | Task | Command Syntax | Command Mode |
|------|---|--|--------------|
| 1 | Configure a maximum number of times that a Request Identity frame can be re-transmitted by the authenticator. | dot1x max-eap-req <i>number</i> Range: 1-10 Default: 2 | INTERFACE |

Figure 6-7 shows configuration information for a port for which the authenticator re-transmits an EAP Request Identity frame after 90 seconds and re-transmits a maximum of 10 times.

Configuring a Quiet Period after a Failed Authentication

If the supplicant fails the authentication process, the authenticator sends another Request Identity frame after 30 seconds by default, but this period can be configured.



Note: The quiet period (dot1x quiet-period) is an transmit interval for after a failed authentication where as the Request Identity Re-transmit interval (dot1x tx-period) is for an unresponsive supplicant.

To configure the quiet period after a failed authentication:

| Step | Task | Command Syntax | Command Mode |
|------|--|--|--------------|
| 1 | Configure the amount of time that the authenticator waits to re-transmit a Request Identity frame after a failed authentication. | dot1x quiet-period <i>seconds</i> Range: 1-65535 Default: 60 | INTERFACE |

Figure 6-7 shows configuration information for a port for which the authenticator re-transmits an EAP Request Identity frame:

- after 90 seconds and a maximum of 10 times for an unresponsive supplicant
- Re-transmits an EAP Request Identity frame

Figure 6-7. Configuring a Request Identity Re-transmissions

```

FTOS(conf-if-range-gi-2/1)#dot1x tx-period 90
FTOS(conf-if-range-gi-2/1)#dot1x max-eap-req 10
FTOS(conf-if-range-gi-2/1)#dot1x quiet-period 120
FTOS#show dot1x interface gigabitethernet 2/1

802.1x information on Gi 2/1:
-----
Dot1x Status:      Enable
Port Control:     AUTO
Port Auth Status: UNAUTHORIZED
Re-Authentication: Disable ← New Re-transmit Interval
Untagged VLAN id: None
Tx Period:        90 seconds ← New Quiet Period
Quiet Period:     120 seconds
ReAuth Max:       2
Supplicant Timeout: 30 seconds
Server Timeout:   30 seconds
Re-Auth Interval: 3600 seconds
Max-EAP-Req:      10 ← New Maximum Re-transmissions
Auth Type:        SINGLE_HOST

Auth PAE State:   Initialize
Backend State:    Initialize

```

Forcibly Authorizing or Unauthorizing a Port

IEEE 802.1X requires that a port can be manually placed into any of three states:

- **ForceAuthorized** is an authorized state. A device connected to this port in this state is never subjected to the authentication process, but is allowed to communicate on the network. Placing the port in this state is same as disabling 802.1X on the port.
- **ForceUnauthorized** an unauthorized state. A device connected to a port in this state is never subjected to the authentication process and is not allowed to communicate on the network. Placing the port in this state is the same as shutting down the port. Any attempt by the supplicant to initiate authentication is ignored.
- **Auto** is an unauthorized state by default. A device connected to this port in this state is subjected to the authentication process. If the process is successful, the port is authorized and the connected device can communicate on the network. All ports are placed in the **auto** state by default.

To place a port in one of these three states:

| Step | Task | Command Syntax | Command Mode |
|------|--|--|--------------|
| 1 | Place a port in the ForceAuthorized, ForceUnauthorized, or Auto state. | dot1x port-control {force-authorized force-unauthorized auto} Default: auto | INTERFACE |

Figure 6-8 shows configuration information for a port that has been force-authorized.

Figure 6-8. Configuring Port-control

```
FTOS(conf-if-gi-2/1)#dot1x port-control force-authorized
FTOS(conf-if-gi-2/1)#do show dot1x interface gigabitethernet 2/1

802.1x information on Gi 2/1:
-----
Dot1x Status:          Enable
Port Control:          FORCE_AUTHORIZED ← New Port-control State
Port Auth Status:      UNAUTHORIZED
Re-Authentication:     Disable
Untagged VLAN id:      None
Tx Period:              90 seconds
Quiet Period:          120 seconds
ReAuth Max:            2
Supplicant Timeout:    30 seconds
Server Timeout:        30 seconds
Re-Auth Interval:      3600 seconds
Max-EAP-Req:           10
Auth Type:              SINGLE_HOST

Auth PAE State:        Initialize
Backend State:         Initialize
Auth PAE State:        Initialize
Backend State:         Initialize
```

Re-authenticating a Port

Periodic Re-authentication

After the supplicant has been authenticated, and the port has been authorized, the authenticator can be configured to re-authenticates the supplicant periodically. If re-authentication is enabled, the supplicant is required to re-authenticate every 3600 seconds, but this interval can be configured. A maximum number of re-authentications can be configured as well.

To configure a re-authentication or a re-authentication period:

| Step | Task | Command Syntax | Command Mode |
|------|---|--|--------------|
| 1 | Configure the authenticator to periodically re-authenticate the supplicant. | dot1x reauthentication [interval] <i>seconds</i> Range: 1-65535 Default:3600 | INTERFACE |

To configure a maximum number of re-authentications:

| Step | Task | Command Syntax | Command Mode |
|------|---|---|--------------|
| 1 | Configure the maximum number of times that the supplicant can be reauthenticated. | dot1x reauth-max <i>number</i> Range: 1-10 Default: 2 | INTERFACE |

Figure 6-9. Configuring a Reauthentication Period

```

FTOS(conf-if-gi-2/1)#dot1x reauthentication interval 7200
FTOS(conf-if-gi-2/1)#dot1x reauth-max 10
FTOS(conf-if-gi-2/1)#do show dot1x interface gigabitethernet 2/1

802.1x information on Gi 2/1:
-----
Dot1x Status:      Enable
Port Control:     FORCE_AUTHORIZED
Port Auth Status:  UNAUTHORIZED ← Re-authentication Enabled
Re-Authentication: Enable
Untagged VLAN id: None
Tx Period:        90 seconds
Quiet Period:     120 seconds
ReAuth Max:       10 ← New Maximum
Supplicant Timeout: 30 seconds
Server Timeout:   30 seconds
Re-Auth Interval: 7200 seconds ← New Re-authentication Period
Max-EAP-Req:      10
Auth Type:        SINGLE_HOST

Auth PAE State:   Initialize
Backend State:    Initialize
Auth PAE State:   Initialize
  
```

Configuring Timeouts

If the supplicant or the authentication server is unresponsive, the authenticator terminates the authentication process after 30 seconds by default. This amount of time that the authenticator waits for a response can be configured.

To terminate the authentication process due to an unresponsive supplicant:

| Step | Task | Command Syntax | Command Mode |
|------|---|--|--------------|
| 1 | Terminate the authentication process due to an unresponsive supplicant. | dot1x supplicant-timeout <i>seconds</i> Range: 1-300 Default: 30 | INTERFACE |

To terminate the authentication process due to an unresponsive authentication server:

| Step | Task | Command Syntax | Command Mode |
|------|--|--|--------------|
| 1 | Terminate the authentication process due to an unresponsive authentication server. | dot1x server-timeout <i>seconds</i> Range: 1-300 Default: 30 | INTERFACE |

Figure 6-10 shows configuration information for a port for which the authenticator terminates the authentication process for an unresponsive supplicant or server after 15 seconds.

Figure 6-10. Configuring a Timeout

```

FTOS(conf-if-gi-2/1)#dot1x port-control force-authorized
FTOS(conf-if-gi-2/1)#do show dot1x interface gigabitethernet 2/1

802.1x information on Gi 2/1:
-----
Dot1x Status:           Enable
Port Control:           FORCE_AUTHORIZED
Port Auth Status:       UNAUTHORIZED
Re-Authentication:      Disable
Untagged VLAN id:       None
Guest VLAN:             Disable
Guest VLAN id:          NONE
Auth-Fail VLAN:         Disable
Auth-Fail VLAN id:      NONE
Auth-Fail Max-Attempts: NONE
Tx Period:              90 seconds
Quiet Period:           120 seconds
ReAuth Max:             10
Supplicant Timeout:    15 seconds
Server Timeout:         15 seconds
Re-Auth Interval:      7200 seconds
Max-EAP-Req:           10
Auth Type:              SINGLE_HOST

Auth PAE State:         Initialize
Backend State:          Initialize

```

← **New Supplicant and Server Timeouts**

Dynamic VLAN Assignment with Port Authentication

FTOS supports dynamic VLAN assignment when using 802.1X. The basis for VLAN assignment is RADIUS attribute 81, Tunnel-Private-Group-ID. Dynamic VLAN assignment uses the standard dot1x procedure: 1) the host sends a dot1x packet to the Dell Force10 system, 2) the system forwards a RADIUS REQUEST packet containing the host MAC address and ingress port number, and 3) the RADIUS server authenticates the request and returns a RADIUS ACCEPT message with the VLAN assignment using Tunnel-Private-Group-ID.

| Step | Task |
|------|---|
| 1 | Configure 802.1x globally and at interface level (see Enabling 802.1X on page 97) along with relevant RADIUS server configurations (Figure 6-11) |
| 2 | Make the interface a switchport so that it can be assigned to a VLAN. |
| 3 | Create the VLAN to which the interface will be assigned. |
| 4 | Connect the supplicant to the port configured for 802.1X. |
| 5 | Verify that the port has been authorized and placed in the desired VLAN (Figure 6-11 , red text). |

In [Figure 6-11](#) shows the configuration on the Dell Force10 system before connecting the end-user device in black and blue text, and after connecting the device in red text. The blue text corresponds to the preceding numbered steps on dynamic VLAN assignment with 802.1X.

Figure 6-11. Dynamic VLAN Assignment with 802.1X

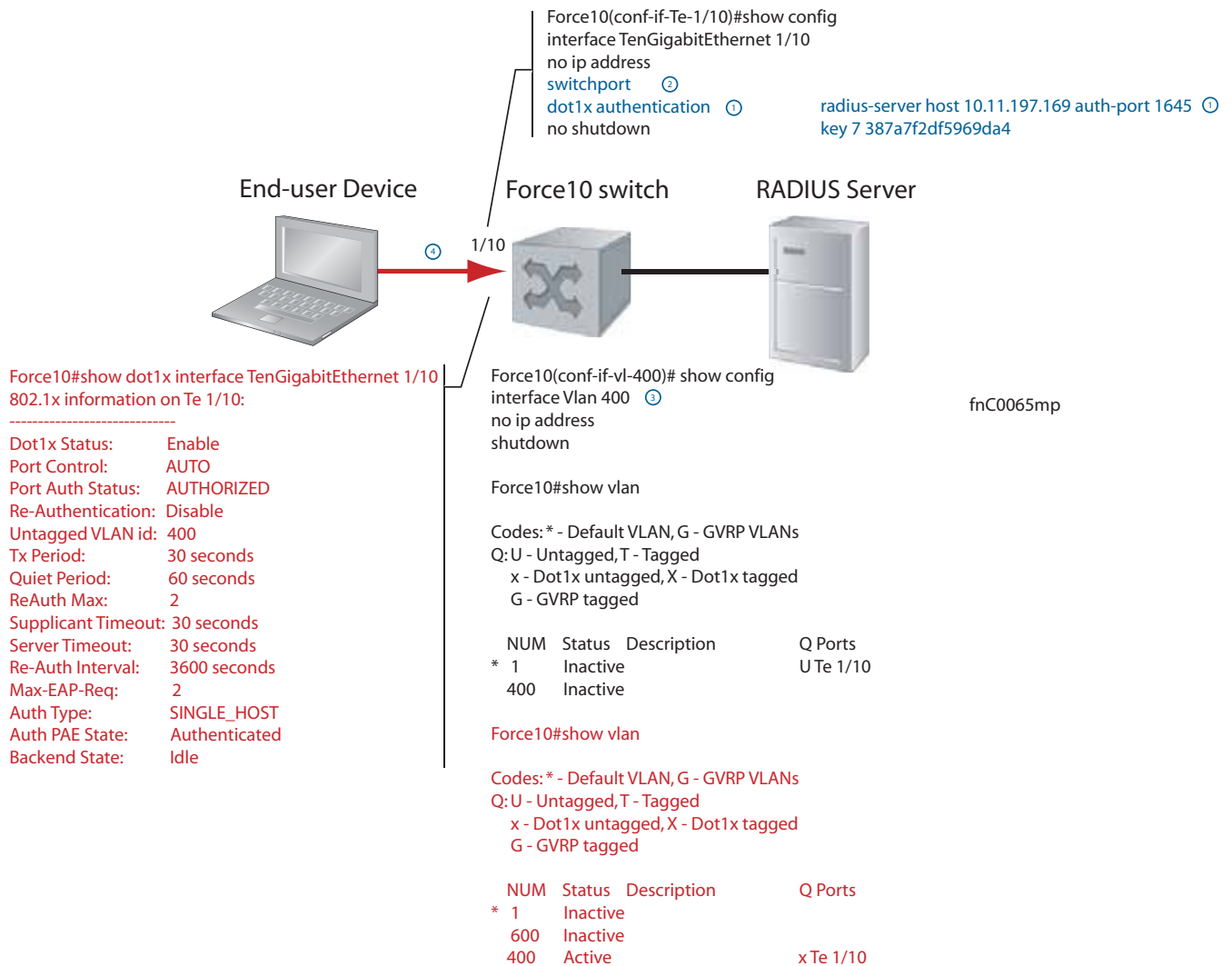

Guest and Authentication-fail VLANs

Typically, the authenticator (Dell Force10 system) denies the supplicant access to the network until the supplicant is authenticated. If the supplicant is authenticated, the authenticator enables the port and places it in either the VLAN for which the port is configured, or the VLAN that the authentication server indicates in the authentication data.



Note: Ports cannot be dynamically assigned to the default VLAN.

If the supplicant fails authentication, the authenticator typically does not enable the port. In some cases this behavior is not appropriate. External users of an enterprise network, for example, might not be able to be authenticated, but still need access to the network. Also, some dumb-terminals such as network printers do not have 802.1X capability and therefore cannot authenticate themselves. To be able to connect such devices, they must be allowed access the network without compromising network security.

The Guest VLAN 802.1X extension addresses this limitation with regard to non-802.1X capable devices, and the Authentication-fail VLAN 802.1X extension addresses this limitation with regard to external users.

- If the supplicant fails authentication a specified number of times, the authenticator places the port in the Authentication-fail VLAN.
- If a port is already forwarding on the Guest VLAN when 802.1X is enabled, then the port is moved out of the Guest VLAN, and the authentication process begins.

Configuring a Guest VLAN

If the supplicant does not respond within a determined amount of time ($[reauth-max + 1] * tx-period$, see [Configuring Timeouts on page 103](#)) the system assumes that the host does not have 802.1X capability, and the port is placed in the Guest VLAN.

Configure a port to be placed in the Guest VLAN after failing to respond within the timeout period using the command `dot1x guest-vlan` from INTERFACE mode, as shown in [Figure 6-12](#).

Figure 6-12. Configuring a Guest VLAN

```
FTOS(conf-if-gi-1/2)#dot1x guest-vlan 200
FTOS(conf-if-gi-1/2)#show config
!
interface GigabitEthernet 1/2
  switchport
  dot1x guest-vlan 200
  no shutdown
FTOS(conf-if-gi-1/2)#
```

View your configuration using the command `show config` from INTERFACE mode, as shown in [Figure 6-12](#), or using the command `show dot1x interface` command from EXEC Privilege mode as shown in [Figure 6-14](#).

Configuring an Authentication-fail VLAN

If the supplicant fails authentication, the authenticator re-attempts to authenticate after a specified amount of time (30 seconds by default, see [Configuring a Quiet Period after a Failed Authentication on page 100](#)). You can configure the maximum number of times the authenticator re-attempts authentication after a failure (3 by default), after which the port is placed in the Authentication-fail VLAN.

Configure a port to be placed in the VLAN after failing the authentication process as specified number of times using the command `dot1x auth-fail-vlan` from INTERFACE mode, as shown in [Figure 6-13](#). Configure the maximum number of authentication attempts by the authenticator using the keyword `max-attempts` with this command.

Figure 6-13. Configuring an Authentication-fail VLAN

```
FTOS(conf-if-gi-1/2)#dot1x auth-fail-vlan 100 max-attempts 5
FTOS(conf-if-gi-1/2)#show config
!
interface GigabitEthernet 1/2
 switchport
 dot1x guest-vlan 200
 dot1x auth-fail-vlan 100 max-attempts 5
 no shutdown
FTOS(conf-if-gi-1/2)#
```

View your configuration using the command `show config` from INTERFACE mode, as shown in [Figure 6-12](#), or using the command `show dot1x interface` command from EXEC Privilege mode as shown in [Figure 6-14](#).

Figure 6-14. Viewing Guest and Authentication-fail VLAN Configurations

```
FTOS(conf-if-gi-2/1)#dot1x port-control force-authorized
FTOS(conf-if-gi-2/1)#do show dot1x interface gigabitethernet 2/1

802.1x information on Gi 2/1:
-----
Dot1x Status:           Enable
Port Control:           FORCE_AUTHORIZED
Port Auth Status:       UNAUTHORIZED
Re-Authentication:      Disable
Untagged VLAN id:       None
Guest VLAN:             Enable
Guest VLAN id:          200
Auth-Fail VLAN:         Enable
Auth-Fail VLAN id:      100
Auth-Fail Max-Attempts: 5
Tx Period:              90 seconds
Quiet Period:           120 seconds
ReAuth Max:             10
Supplicant Timeout:     15 seconds
Server Timeout:         15 seconds
Re-Auth Interval:       7200 seconds
Max-EAP-Req:            10
Auth Type:              SINGLE_HOST

Auth PAE State:         Initialize
Backend State:          Initialize
```

Access Control Lists (ACLs)

This chapter describes the [Access Control Lists \(ACLs\)](#), prefix lists, and route-maps.

Access Control Lists (ACLs) are supported on platforms: e c s **S4810** **S4820T**

Ingress IP and MAC ACLs are supported on platforms: e c s **S4810** **S4820T**

Egress IP and MAC ACLs are supported on platforms: e s **S4810** **S4820T**

Overview

At their simplest, Access Control Lists (ACLs), Prefix lists, and Route-maps permit or deny traffic based on MAC and/or IP addresses. This chapter discusses implementing IP ACLs, IP Prefix lists and Route-maps. For MAC ACLS, refer to [Layer 2](#).

An ACL is essentially a filter containing some criteria to match (examine IP, TCP, or UDP packets) and an action to take (permit or deny). ACLs are processed in sequence so that if a packet does not match the criterion in the first filter, the second filter (if configured) is applied. When a packet matches a filter, the switch drops or forwards the packet based on the filter's specified action. If the packet does not match any of the filters in the ACL, the packet is dropped (implicit deny).

The number of ACLs supported on a system depends on your CAM size. See [CAM Profiling](#), [CAM Allocation](#), and [CAM Optimization](#) in this chapter for more information. Refer to [Content Addressable Memory \(CAM\)](#) for complete CAM profiling information.

This chapter covers the following topics:

- IP Access Control Lists (ACLs)
 - [CAM Profiling, CAM Allocation, and CAM Optimization](#)
 - [Implementing ACLs on FTOS](#)
- IP Fragment Handling
- [Configure a standard IP ACL](#)
- [Configure an extended IP ACL](#)
- [Configuring Layer 2 and Layer 3 ACLs on an Interface](#)
- [Assign an IP ACL to an Interface](#)
- [Configuring Ingress ACLs](#)
- [Configuring Egress ACLs](#)

- [Configuring ACLs to Loopback](#)
 - [Applying an ACL on Loopback Interfaces](#)
- [IP Prefix Lists](#)
- [ACL Resequencing](#)
- [Route Maps](#)

IP Access Control Lists (ACLs)

In the Dell Force10 switch/routers, you can create two different types of IP ACLs: standard or extended. A standard ACL filters packets based on the source IP packet. An extended ACL filters traffic based on the following criteria (for more information on ACL supported options see the *FTOS Command Reference*):

- IP protocol number
- Source IP address
- Destination IP address
- Source TCP port number
- Destination TCP port number
- Source UDP port number
- Destination UDP port number

For extended ACL TCP and UDP filters, you can match criteria on specific or ranges of TCP or UDP ports. For extended ACL TCP filters, you can also match criteria on established TCP sessions.

When creating an access list, the sequence of the filters is important. You have a choice of assigning sequence numbers to the filters as you enter them, or FTOS will assign numbers in the order the filters are created. The sequence numbers, whether configured or assigned by FTOS, are listed in the **show config** and **show ip accounting access-list** command display output.

Ingress and egress [Hot Lock ACLs](#) allow you to append or delete new rules into an existing ACL (already written into CAM) without disrupting traffic flow. Existing entries in CAM are shuffled to accommodate the new entries. Hot Lock ACLs are enabled by default and support both standard and extended ACLs and on all platforms.



Note: Hot Lock ACLs are supported for Ingress ACLs only.

CAM Profiling, CAM Allocation, and CAM Optimization

[CAM Profiling](#) is supported on platform **E**

[User Configurable CAM Allocations](#) are supported on platform **C** and **S**

[CAM optimization](#) is supported on platforms **C** **S**

CAM Profiling

[CAM optimization](#) is supported on platforms **E t**

The default CAM profile has 1K Layer 2 ingress ACL entries. If you need more memory for Layer 2 ingress ACLs, select the profile *l2-ipv4-inacl*.

When budgeting your CAM allocations for ACLs and QoS configurations, remember that ACL and QoS rules might consume more than one CAM entry depending on complexity. For example, TCP and UDP rules with port range options might require more than one CAM entry.

The Layer 2 ACL CAM partition has sub-partitions for several types of information. [Table 7-1](#) lists the sub-partition and the percentage of the Layer 2 ACL CAM partition that FTOS allocates to each by default.

Table 7-1. Layer 2 ACL CAM Sub-partition Sizes

| Partition | % Allocated |
|-----------|-------------|
| Sysflow | 6 |
| L2ACL | 14 |
| *PVST | 50 |
| QoS | 12 |
| L2PT | 13 |
| FRRP | 5 |

You can re-configure the amount of space, in percentage, allocated to each sub-partition. As with the IPv4Flow partition, you can configure the Layer 2 ACL partition from EXEC Privilege mode or CONFIGURATION mode.

The amount of space that you can distribute to the sub-partitions is equal to the amount of CAM space that the selected CAM profile allocates to the Layer 2 ACL partition. FTOS requires that you specify the amount of CAM space for all sub-partitions and that the sum of all sub-partitions is 100%. FTOS displays the following message if the total allocated space is not correct:

```
% Error: Sum of all regions does not total to 100%.
```

User Configurable CAM Allocation

[User Configurable CAM Allocations](#) are supported on platforms **C** **S4810** and **S4820T**

Allocate space for IPV6 ACLs on the by using the `cam-acl` command in CONFIGURATION mode.

The CAM space is allotted in FP blocks. The total space allocated must equal 13 FP blocks. Note that there are 16 FP blocks, but the System Flow requires 3 blocks that cannot be reallocated. The default CAM Allocation settings on a C-Series matching are:

- L3 ACL (ipv4acl): 6
- L2 ACL(l2acl): 5
- IPv6 L3 ACL (ipv6acl): 0
- L3 QoS (ipv4qos): 1
- L2 QoS (l2qos): 1

The `ipv6acl` allocation must be entered as a factor of 2 (2, 4, 6, 8, 10). All other profile allocations can use either even or odd numbered ranges.

You must save the new CAM settings to the startup-config (`write mem` or `copy run start`) then reload the system for the new settings to take effect.

CAM optimization

[CAM optimization](#) is supported on platforms **C S**

When this command is enabled, if a Policy Map containing classification rules (ACL and/or dscp/ip-precedence rules) is applied to more than one physical interface on the same port-pipe, only a single copy of the policy is written (only 1 FP entry will be used). When the command is disabled, the system behaves as described in this chapter.

Test CAM Usage

The `test cam-usage` command is supported on platforms **C e S**

This command applies to both IPv4 and IPv6 CAM profiles, but is best used when verifying QoS optimization for IPv6 ACLs.

Use this command to determine whether sufficient ACL CAM space is available to enable a service-policy. Create a Class Map with all required ACL rules, then execute the `test cam-usage` command in Privilege mode to verify the actual CAM space required. The example below gives a sample of the output shown when executing the command. The status column indicates whether or not the policy can be enabled.

```
FTOS#test cam-usage service-policy input TestPolicy linecard all
```

| Linecard | Portpipe | CAM Partition | Available CAM | Estimated CAM per Port | Status |
|----------|----------|---------------|---------------|------------------------|---------|
| 2 | 1 | IPv4Flow | 232 | 0 | Allowed |
| 2 | 1 | IPv6Flow | 0 | 0 | Allowed |
| 4 | 0 | IPv4Flow | 232 | 0 | Allowed |
| 4 | 0 | IPv6Flow | 0 | 0 | Allowed |

```
FTOS#
```

Implementing ACLs on FTOS

One IP ACL can be assigned per interface with FTOS. If an IP ACL is not assigned to an interface, it is not used by the software in any other capacity.

The number of entries allowed per ACL is hardware-dependent. Refer to your line card documentation for detailed specification on entries allowed per ACL.

If counters are enabled on IP ACL rules that are already configured, those counters are reset when a new rule is inserted or prepended. If a rule is appended, the existing counters are not affected. This is applicable to the following features:

- L2 Ingress Access list
- L2 Egress Access list
- L3 Egress Access list



Note: IP ACLs are supported over VLANs in Version 6.2.1.1 and higher.

ACLs and VLANs

There are some differences when assigning ACLs to a VLAN rather than a physical port. For example, when using a single port-pipe, if you apply an ACL to a VLAN, one copy of the ACL entries would get installed in the ACL CAM on the port-pipe. The entry would look for the incoming VLAN in the packet. Whereas if you apply an ACL on individual ports of a VLAN, separate copies of the ACL entries would be installed for each port belonging to a port-pipe.

When you use the `log` keyword, CP processor will have to log details about the packets that match. Depending on how many packets match the log entry and at what rate, CP might become busy as it has to log these packets' details. However the other processors (RP1 and RP2) should be unaffected. This option is typically useful when debugging some problem related to control traffic. We have used this option numerous times in the field and have not encountered any problems in such usage so far.

ACL Optimization

If an access list contains duplicate entries, FTOS deletes one entry to conserve CAM space. Standard and Extended ACLs take up the same amount of CAM space. A single ACL rule uses 2 CAM entries whether it is identified as a Standard or Extended ACL.

Determine the order in which ACLs are used to classify traffic

When you link class-maps to queues using the command `service-queue`, FTOS matches the class-maps according to queue priority (queue numbers closer to 0 have lower priorities). For example, in the example below, class-map `cmap2` is matched against ingress packets before `cmap1`.

ACLs *acl1* and *acl2* have overlapping rules because the address range 20.1.1.0/24 is within 20.0.0.0/8. Therefore, (without the keyword *order*) packets within the range 20.1.1.0/24 match positive against *cmap1* and are buffered in queue 7, though you intended for these packets to match positive against *cmap2* and be buffered in queue 4.

In cases such as these, where class-maps with overlapping ACL rules are applied to different queues, use the *order* keyword to specify the order in which you want to apply ACL rules, as shown in the example below. The order can range from 0 to 254. FTOS writes to the CAM ACL rules with lower order numbers (order numbers closer to 0) before rules with higher order numbers so that packets are matched as you intended. By default, all ACL rules have an order of 254.

```
FTOS(conf)#ip access-list standard acl1
FTOS(config-std-nacl)#permit 20.0.0.0/8
FTOS(config-std-nacl)#exit
FTOS(conf)#ip access-list standard acl2
FTOS(config-std-nacl)#permit 20.1.1.0/24 order 0
FTOS(config-std-nacl)#exit
FTOS(conf)#class-map match-all cmap1
FTOS(conf-class-map)#match ip access-group acl1
FTOS(conf-class-map)#exit
FTOS(conf)#class-map match-all cmap2
FTOS(conf-class-map)#match ip access-group acl2
FTOS(conf-class-map)#exit
FTOS(conf)#policy-map-input pmap
FTOS(conf-policy-map-in)#service-queue 7 class-map cmap1
FTOS(conf-policy-map-in)#service-queue 4 class-map cmap2
FTOS(conf-policy-map-in)#exit
FTOS(conf)#interface gig 1/0
FTOS(conf-if-gi-1/0)#service-policy input pmap
```

IP Fragment Handling

FTOS supports a configurable option to explicitly deny IP fragmented packets, particularly second and subsequent packets. It extends the existing ACL command syntax with the *fragments* keyword for all Layer 3 rules applicable to all Layer protocols (*permit/deny ip/tcp/udp/icmp*).

- Both standard and extended ACLs support IP fragments.
- Second and subsequent fragments are allowed because a Layer 4 rule cannot be applied to these fragments. If the packet is to be denied eventually, the first fragment would be denied and hence the packet as a whole cannot be reassembled.
- Implementing the required rules will use a significant number of CAM entries per TCP/UDP entry.
- For IP ACL, FTOS always applies implicit deny. You do not have to configure it.
- For IP ACL, FTOS applies implicit permit for second and subsequent fragment just prior to the implicit deny.
- If an *explicit* deny is configured, the second and subsequent fragments will not hit the implicit permit rule for fragments.

- Loopback interfaces do not support ACLs using the IP fragment option. If you configure an ACL with the fragments option and apply it to a loopback interface, the command is accepted, but the ACL entries are not actually installed the offending rule in CAM.

IP fragments ACL examples

The following configuration permits all packets (both fragmented & non-fragmented) with destination IP 10.1.1.1. The second rule does not get hit at all.

```
FTOS(conf)#ip access-list extended ABC
FTOS(conf-ext-nacl)#permit ip any 10.1.1.1/32
FTOS(conf-ext-nacl)#deny ip any 10.1.1.1./32 fragments
FTOS(conf-ext-nacl)
```

To deny second/subsequent fragments, use the same rules in a different order. These ACLs deny all second & subsequent fragments with destination IP 10.1.1.1 but permit the first fragment & non fragmented packets with destination IP 10.1.1.1.

```
FTOS(conf)#ip access-list extended ABC
FTOS(conf-ext-nacl)#deny ip any 10.1.1.1/32 fragments
FTOS(conf-ext-nacl)#permit ip any 10.1.1.1/32
FTOS(conf-ext-nacl)
```

Layer 4 ACL rules examples

In the below scenario, first fragments non-fragmented TCP packets from 10.1.1.1 with TCP destination port equal to 24 are permitted. All other fragments are denied.

```
FTOS(conf)#ip access-list extended ABC
FTOS(conf-ext-nacl)#permit tcp host 10.1.1.1 any eq 24
FTOS(conf-ext-nacl)#deny ip any any fragment
FTOS(conf-ext-nacl)
```

In the following, TCP packets that are first fragments or non-fragmented from host 10.1.1.1 with TCP destination port equal to 24 are permitted. Additionally, all TCP non-first fragments from host 10.1.1.1 are permitted. All other IP packets that are non-first fragments are denied.

```
FTOS(conf)#ip access-list extended ABC
FTOS(conf-ext-nacl)#permit tcp host 10.1.1.1 any eq 24
FTOS(conf-ext-nacl)#permit tcp host 10.1.1.1 any fragment
FTOS(conf-ext-nacl)#deny ip any any fragment
FTOS(conf-ext-nacl)
```

To log all the packets denied and to override the implicit deny rule and the implicit permit rule for TCP/UDP fragments, use a configuration similar to the following.

```
FTOS(conf)#ip access-list extended ABC
FTOS(conf-ext-nacl)#permit tcp any any fragment
FTOS(conf-ext-nacl)#permit udp any any fragment
FTOS(conf-ext-nacl)#deny ip any any log
```

FTOS (conf-ext-nacl)



Note the following when configuring ACLs with the fragments keyword.

When an ACL filters packets it looks at the Fragment Offset (FO) to determine whether or not it is a fragment.

- FO = 0 means it is either the first fragment or the packet is a non-fragment.
- FO > 0 means it is dealing with the fragments of the original packet.

Permit ACL line with L3 information only, and the fragments keyword is present:

If a packet's L3 information matches the L3 information in the ACL line, the packet's fragment offset (FO) is checked.

- If a packet's FO > 0, the packet is permitted.
- If a packet's FO = 0, the next ACL entry is processed.

Deny ACL line with L3 information only, and the fragments keyword is present:

If a packet's L3 information does match the L3 information in the ACL line, the packet's fragment offset (FO) is checked.

- If a packet's FO > 0, the packet is denied.
- If a packet's FO = 0, the next ACL line is processed.

Configure a standard IP ACL

To configure an ACL, use commands in the IP ACCESS LIST mode and the INTERFACE mode. The following list includes the configuration tasks for IP ACLs:

For a complete listing of all commands related to IP ACLs, refer to the *FTOS Command Line Interface Reference* document.

Refer to [Configure an extended IP ACL](#) to set up extended ACLs.

A standard IP ACL uses the source IP address as its match criterion.

To configure a standard IP ACL, use these commands in the following sequence:

| Step | Command Syntax | Command Mode | Purpose |
|------|--|-----------------|---|
| 1 | ip access-list standard <i>access-listname</i> | CONFIGURATION | Enter IP ACCESS LIST mode by naming a standard IP access list. |
| 2 | seq <i>sequence-number</i> { deny permit } { <i>source</i> [<i>mask</i>] any host <i>ip-address</i> } [count [<i>byte</i>] log] [order] [monitor] [fragments] | CONFIG-STD-NACL | Configure a drop or forward filter. The parameters are: <ul style="list-style-type: none"> • log and monitor options are supported on E-Series only. |



Note: When assigning sequence numbers to filters, keep in mind that you might need to insert a new filter. To prevent reconfiguring multiple filters, assign sequence numbers in multiples of five or another number.

When you use the log keyword, CP processor logs details about the packets that match. Depending on how many packets match the log entry and at what rate, the CP may become busy as it has to log these packets' details.

To view the rules of a particular ACL configured on a particular interface, use the **show ip accounting access-list *ACL-name* interface *interface*** command in EXEC Privilege mode as shown in the example below.

```
FTOS#show ip accounting access Toospf interface gig 1/6
Standard IP access list Toospf
  seq 5 deny any
  seq 10 deny 10.2.0.0 /16
  seq 15 deny 10.3.0.0 /16
  seq 20 deny 10.4.0.0 /16
  seq 25 deny 10.5.0.0 /16
  seq 30 deny 10.6.0.0 /16
  seq 35 deny 10.7.0.0 /16
  seq 40 deny 10.8.0.0 /16
  seq 45 deny 10.9.0.0 /16
  seq 50 deny 10.10.0.0 /16
FTOS#
```

The example below illustrates how the **seq** command orders the filters according to the sequence number assigned. In the example, filter 25 was configured before filter 15, but the **show config** command displays the filters in the correct order.

```
FTOS(config-std-nacl)#seq 25 deny ip host 10.5.0.0 any log
FTOS(config-std-nacl)#seq 15 permit tcp 10.3.0.0 /16 any
FTOS(config-std-nacl)#show config
!
ip access-list standard dilling
  seq 15 permit tcp 10.3.0.0/16 any
  seq 25 deny ip host 10.5.0.0 any log
FTOS(config-std-nacl)#
```

To delete a filter, use the **no seq *sequence-number*** command in the IP ACCESS LIST mode.

If you are creating a standard ACL with only one or two filters, you can let FTOS assign a sequence number based on the order in which the filters are configured. The software assigns filters in multiples of 5.

To configure a filter without a specified sequence number, use these commands in the following sequence, starting in the CONFIGURATION mode:

| Step | Command Syntax | Command Mode | Purpose |
|------|---|---------------|---|
| 1 | ip access-list standard <i>access-list-name</i> | CONFIGURATION | Create a standard IP ACL and assign it a unique name. |

| Step | Command Syntax | Command Mode | Purpose |
|------|---|-----------------|--|
| 2 | {deny permit} {source [mask] any host ip-address} [count [byte] log] [order] [monitor] [fragments] | CONFIG-STD-NACL | Configure a drop or forward IP ACL filter. <ul style="list-style-type: none"> log and monitor options are supported on E-Series only. |

When you use the **log** keyword, CP processor logs details about the packets that match. Depending on how many packets match the log entry and at what rate, the CP may become busy as it has to log these packets' details.

The example below illustrates a standard IP ACL in which the sequence numbers were assigned by the FTOS. The filters were assigned sequence numbers based on the order in which they were configured (for example, the first filter was given the lowest sequence number). The **show config** command in the IP ACCESS LIST mode displays the two filters with the sequence numbers 5 and 10.

```
FTOS(config-route-map)#ip access standard kigali
FTOS(config-std-nacl)#permit 10.1.0.0/16
FTOS(config-std-nacl)#show config
!
ip access-list standard kigali
  seq 5 permit 10.1.0.0/16
FTOS(config-std-nacl)#
```

To view all configured IP ACLs, use the **show ip accounting access-list** command in the EXEC Privilege mode as shown in the example below.

```
FTOS#show ip accounting access example interface gig 4/12
Extended IP access list example
seq 10 deny tcp any any eq 111
  seq 15 deny udp any any eq 111
  seq 20 deny udp any any eq 2049
  seq 25 deny udp any any eq 31337
  seq 30 deny tcp any any range 12345 12346
  seq 35 permit udp host 10.21.126.225 10.4.5.0 /28
  seq 40 permit udp host 10.21.126.226 10.4.5.0 /28
  seq 45 permit udp 10.8.0.0 /16 10.50.188.118 /31 range 1812 1813
  seq 50 permit tcp 10.8.0.0 /16 10.50.188.118 /31 eq 49
  seq 55 permit udp 10.15.1.0 /24 10.50.188.118 /31 range 1812 1813
```

To delete a filter, enter the **show config** command in the IP ACCESS LIST mode and locate the sequence number of the filter you want to delete. Then use the **no seq sequence-number** command in the IP ACCESS LIST mode.

Configure an extended IP ACL

Extended IP ACLs filter on source and destination IP addresses, IP host addresses, TCP addresses, TCP host addresses, UDP addresses, and UDP host addresses.

Since traffic passes through the filter in the order of the filter's sequence, you can configure the extended IP ACL by first entering the IP ACCESS LIST mode and then assigning a sequence number to the filter.



Note: On E-Series ExaScale systems, TCP ACL flags are not supported in an extended ACL with IPv6 microcode. An error message is shown if IPv6 microcode is configured and an ACL is entered with a TCP filter included.

```
FTOS(conf-ipv6-acl)#seq 8 permit tcp any any urg
May 5 08:32:34: %E90MJ:0 %ACL_AGENT-2-ACL_AGENT_ENTRY_ERROR: Unable to write seq
8 of list test as individual TCP flags are not supported on linecard 0
```

Configure filters with sequence number

To create a filter for packets with a specified sequence number, use these commands in the following sequence, starting in the CONFIGURATION mode:

| Step | Command Syntax | Command Mode | Purpose |
|------|---|-----------------|--|
| 1 | ip access-list extended <i>access-list-name</i> | CONFIGURATION | Enter the IP ACCESS LIST mode by creating an extended IP ACL. |
| 2 | seq <i>sequence-number</i> { deny permit } { <i>ip-protocol-number</i> icmp ip tcp udp } { <i>source mask</i> any host <i>ip-address</i> } { <i>destination</i> <i>mask</i> any host <i>ip-address</i> } [<i>operator</i> <i>port</i> [<i>port</i>]] [count [byte] log] [order] [monitor] [fragments] | CONFIG-EXT-NACL | Configure a drop or forward filter. • log and monitor options are supported on E-Series only. |

When you use the log keyword, CP processor logs details about the packets that match. Depending on how many packets match the log entry and at what rate, the CP may become busy as it has to log these packets' details.

TCP packets: To create a filter for TCP packets with a specified sequence number, use these commands in the following sequence, starting in the CONFIGURATION mode:

| Step | Command Syntax | Command Mode | Purpose |
|------|---|---------------|--|
| 1 | ip access-list extended <i>access-list-name</i> | CONFIGURATION | Create an extended IP ACL and assign it a unique name. |

| Step | Command Syntax | Command Mode | Purpose |
|------|--|-----------------|--|
| 2 | seq <i>sequence-number</i> { deny permit } tcp { <i>source mask</i> any host <i>ip-address</i> }} [count [byte] log] [order] [monitor] [fragments] | CONFIG-EXT-NACL | Configure an extended IP ACL filter for TCP packets. <ul style="list-style-type: none"> • log and monitor options are supported on E-Series only. |

When you use the **log** keyword, CP processor logs details about the packets that match. Depending on how many packets match the log entry and at what rate, the CP may become busy as it has to log these packets' details.

UDP packets: To create a filter for UDP packets with a specified sequence number, use these commands in the following sequence, starting in the CONFIGURATION mode:

| Step | Command Syntax | Command Mode | Purpose |
|------|---|-----------------|--|
| 1 | ip access-list extended <i>access-list-name</i> | CONFIGURATION | Create a extended IP ACL and assign it a unique name. |
| 2 | seq <i>sequence-number</i> { deny permit } { <i>ip-protocol-number</i> udp } { <i>source mask</i> any host <i>ip-address</i> } { <i>destination mask</i> any host <i>ip-address</i> } [<i>operator port</i> [<i>port</i>]] [count [byte] log] [order] [monitor] [fragments] | CONFIG-EXT-NACL | Configure an extended IP ACL filter for UDP packets. <ul style="list-style-type: none"> • log and monitor options are supported on E-Series only. |

When you create the filters with a specific sequence number, you can create the filters in any order and the filters are placed in the correct order.



Note: When assigning sequence numbers to filters, keep in mind that you might need to insert a new filter. To prevent reconfiguring multiple filters, assign sequence numbers in multiples of five or another number.

The following example illustrates how the **seq** command orders the filters according to the sequence number assigned. In the example, filter 15 was configured before filter 5, but the **show config** command displays the filters in the correct order.

```
FTOS(config-ext-nacl)#seq 15 deny ip host 112.45.0.0 any log
FTOS(config-ext-nacl)#seq 5 permit tcp 12.1.3.45 0.0.255.255 any
FTOS(config-ext-nacl)#show confi
```

```

!
ip access-list extended dilling
  seq 5 permit tcp 12.1.0.0 0.0.255.255 any
  seq 15 deny ip host 112.45.0.0 any log
FTOS(config-ext-nacl)#

```

Configure filters without sequence number

If you are creating an extended ACL with only one or two filters, you can let FTOS assign a sequence number based on the order in which the filters are configured. FTOS assigns filters in multiples of 5.

To configure a filter for an extended IP ACL without a specified sequence number, use any or all of the following commands in the IP ACCESS LIST mode:

| Command Syntax | Command Mode | Purpose |
|--|-----------------|--|
| <code>{deny permit} {source mask any host ip-address} [count [byte] log] [order] [monitor] [fragments]</code> | CONFIG-EXT-NACL | Configure a deny or permit filter to examine IP packets. <ul style="list-style-type: none"> log and monitor options are supported on E-Series only. |
| <code>{deny permit} tcp {source mask any host ip-address} [count [byte] log] [order] [monitor] [fragments]</code> | CONFIG-EXT-NACL | Configure a deny or permit filter to examine TCP packets. <ul style="list-style-type: none"> log and monitor options are supported on E-Series only. |
| <code>{deny permit} udp {source mask any host ip-address} [count [byte] log] [order] [monitor] [fragments]</code> | CONFIG-EXT-NACL | Configure a deny or permit filter to examine UDP packets. <ul style="list-style-type: none"> log and monitor options are supported on E-Series only. |

When you use the `log` keyword, CP processor logs details about the packets that match. Depending on how many packets match the log entry and at what rate, the CP may become busy as it has to log these packets' details.

The following example illustrates an extended IP ACL in which the sequence numbers were assigned by the software. The filters were assigned sequence numbers based on the order in which they were configured (for example, the first filter was given the lowest sequence number). The `show config` command in the IP ACCESS LIST mode displays the two filters with the sequence numbers 5 and 10.

```

FTOS(config-ext-nacl)#deny tcp host 123.55.34.0 any
FTOS(config-ext-nacl)#permit udp 154.44.123.34 0.0.255.255 host 34.6.0.0
FTOS(config-ext-nacl)#show config
!
ip access-list extended nimule
  seq 5 deny tcp host 123.55.34.0 any
  seq 10 permit udp 154.44.0.0 0.0.255.255 host 34.6.0.0
FTOS(config-ext-nacl)#

```

To view all configured IP ACLs and the number of packets processed through the ACL, use the **show ip accounting access-list** command in the EXEC Privilege mode as shown in the first example in [Configure a standard IP ACL](#).

Established Flag

The **est** (established) flag is deprecated for Terascale series line cards. The flag is only available on legacy EtherScale linecards. Employ the **ack** and **rst** flags instead to achieve the same functionality.

To obtain the functionality of **est**, use the following ACLs:

- permit tcp any any rst
- permit tcp any any ack

Configuring Layer 2 and Layer 3 ACLs on an Interface

Both Layer 2 and Layer 3 ACLs may be configured on an interface in Layer 2 mode. If both L2 and L3 ACLs are applied to an interface, the following rules apply:

- The packets routed by FTOS are governed by the L3 ACL only, since they are not filtered against an L2 ACL.
- The packets switched by FTOS are first filtered by the L3 ACL, then by the L2 ACL.
- When packets are switched by FTOS, the egress L3 ACL does not filter the packet.

For the following features, if counters are enabled on rules that have already been configured and a new rule is either inserted or prepended, all the existing counters will be reset:

- L2 Ingress Access list
- L3 Egress Access list
- L2 Egress Access list

If a rule is simply appended, existing counters are not affected.

Table 7-2. L2 and L3 ACL Filtering on Switched Packets

| L2 ACL Behavior | L3 ACL Behavior | Decision on Targeted Traffic |
|-----------------|-----------------|------------------------------|
| Deny | Deny | Denied by L3 ACL |
| Deny | Permit | Permitted by L3 ACL |
| Permit | Deny | Denied by L3 ACL |
| Permit | Permit | Permitted by L3 ACL |



Note: If an interface is configured as a **vlan-stack access** port, the packets are filtered by an L2 ACL only. The L3 ACL applied to such a port does not affect traffic. That is, existing rules for other features (such as trace-list, PBR, and QoS) are applied accordingly to the permitted traffic.

For information on MAC ACLs, refer to [Layer 2](#).

Assign an IP ACL to an Interface

Ingress IP ACLs are supported on platforms: **C**

Ingress and Egress IP ACLs are supported on platform: **e** and **S**

To pass traffic through a configured IP ACL, you must assign that ACL to a physical interface, a port channel interface, or a VLAN. The IP ACL is applied to all traffic entering a physical or port channel interface and the traffic is either forwarded or dropped depending on the criteria and actions specified in the ACL.

The same ACL may be applied to different interfaces and that changes its functionality. For example, you can take ACL “ABCD”, and apply it using the **in** keyword and it becomes an ingress access list. If you apply the same ACL using the **out** keyword, it becomes an egress access list. If you apply the same ACL to the loopback interface, it becomes a loopback access list.

This chapter covers the following topics:

- [Configuring Ingress ACLs](#)
- [Configuring Egress ACLs](#)
- [Configuring ACLs to Loopback](#)

For more information on Layer-3 interfaces, refer to [Interfaces](#).

To apply an IP ACL (standard or extended) to a physical or port channel interface, use these commands in the following sequence in the INTERFACE mode:

| Step | Command Syntax | Command Mode | Purpose |
|------|--------------------------------------|---------------|--|
| 1 | interface interface slot/port | CONFIGURATION | Enter the interface number. |
| 2 | ip address ip-address | INTERFACE | Configure an IP address for the interface, placing it in Layer-3 mode. |

| Step | Command Syntax | Command Mode | Purpose |
|------|--|--------------|---|
| 3 | ip access-group <i>access-list-name</i> {in out} [implicit-permit] [vlan <i>vlan-range</i>] | INTERFACE | Apply an IP ACL to traffic entering or exiting an interface. <ul style="list-style-type: none"> out: configure the ACL to filter outgoing traffic. This keyword is supported only on E-Series. Note: The number of entries allowed per ACL is hardware-dependent. Refer to your line card documentation for detailed specification on entries allowed per ACL. |
| 4 | ip access-list [standard extended] <i>name</i> | INTERFACE | Apply rules to the new ACL. |

To view which IP ACL is applied to an interface, use the **show config** command in the INTERFACE mode as shown below or the **show running-config** command in the EXEC mode.

```
FTOS (conf-if) #show conf
!
interface GigabitEthernet 0/0
 ip address 10.2.1.100 255.255.255.0
 ip access-group nimule in
 no shutdown
FTOS (conf-if) #
```

Use only Standard ACLs in the **access-class** command to filter traffic on Telnet sessions.

Counting ACL Hits

You can view the number of packets matching the ACL by using the **count** option when creating ACL entries. E-Series supports packet and byte counts simultaneously. C-Series and S-Series support only one at any given time.

To view the number of packets matching an ACL that is applied to an interface:

| Step | Task |
|------|---|
| 1 | Create an ACL that uses rules with the count option. See Configure a standard IP ACL |
| 2 | Apply the ACL as an inbound or outbound ACL on an interface. See Assign an IP ACL to an Interface |
| 3 | View the number of packets matching the ACL using the show ip accounting access-list from EXEC Privilege mode. |

Configuring Ingress ACLs

Ingress ACLs are applied to interfaces and to traffic entering the system. These system-wide ACLs eliminate the need to apply ACLs onto each interface and achieves the same results. By localizing target traffic, it is a simpler implementation.

To create an ingress ACLs, use the **ip access-group** command in the EXEC Privilege mode as shown below. This example also shows applying the ACL, applying rules to the newly created access group, and viewing the access list:

```
FTOS(conf)#interface gige 0/0
FTOS(conf-if-gige0/0)#ip access-group abcd in
FTOS(conf-if-gige0/0)#show config
!
gigetherenet 0/0
  no ip address
  ip access-group abcd in
  no shutdown
FTOS(conf-if-gige0/0)#end
FTOS#configure terminal
FTOS(conf)#ip access-list extended abcd
FTOS(config-ext-nacl)#permit tcp any any
FTOS(config-ext-nacl)#deny icmp any any
FTOS(config-ext-nacl)#permit 1.1.1.2
FTOS(config-ext-nacl)#end
FTOS#show ip accounting access-list
!
Extended Ingress IP access list abcd on gigetherenet 0/0
  seq 5 permit tcp any any
  seq 10 deny icmp any any
  seq 15 permit 1.1.1.2
```

Configuring Egress ACLs

Egress ACLs are supported on platforms  **S4810** and **S4820T**

Egress ACLs are applied to line cards and affect the traffic leaving the system. Configuring egress ACLs onto physical interfaces protects the system infrastructure from attack—malicious and incidental—by explicitly allowing only authorized traffic. These system-wide ACLs eliminate the need to apply ACLs onto each interface and achieves the same results. By localizing target traffic, it is a simpler implementation.

An egress ACL is used when users would like to restrict egress traffic. For example, when a DOS attack traffic is isolated to one particular interface, you can apply an egress ACL to block that particular flow from exiting the box, thereby protecting downstream devices.

To create an egress ACLs, use the **ip access-group** command in the EXEC Privilege mode as shown in the example below. This example also shows viewing the configuration, applying rules to the newly created access group, and viewing the access list:

```
FTOS(conf)#interface gige 0/0
FTOS(conf-if-gige0/0)#ip access-group abcd out
FTOS(conf-if-gige0/0)#show config
!
gigetherenet 0/0
  no ip address
  ip access-group abcd out
  no shutdown
FTOS(conf-if-gige0/0)#end
FTOS#configure terminal
FTOS(conf)#ip access-list extended abcd
FTOS(config-ext-nacl)#permit tcp any any
FTOS(config-ext-nacl)#deny icmp any any
FTOS(config-ext-nacl)#permit 1.1.1.2
FTOS(config-ext-nacl)#end
FTOS#show ip accounting access-list
!
Extended Ingress IP access list abcd on gigetherenet 0/0
  seq 5 permit tcp any any
  seq 10 deny icmp any any
  seq 15 permit 1.1.1.2
```

Egress Layer 3 ACL Lookup for Control-plane IP Traffic

By default, packets originated from the system are not filtered by egress ACLs. If you initiate a ping session from the system, for example, and apply an egress ACL to block this type of traffic on the interface, the ACL does not affect that ping traffic. The Control Plane Egress Layer 3 ACL feature enhances IP reachability debugging by implementing control-plane ACLs for CPU-generated and CPU-forwarded traffic. Using **permit** rules with the **count** option, you can track on a per-flow basis whether CPU-generated and CPU-forwarded packets were transmitted successfully..

| Task | Command Syntax | Command Mode |
|---|---|---------------|
| Apply Egress ACLs to IPv4 system traffic. | ip control-plane [egress filter] | CONFIGURATION |
| Apply Egress ACLs to IPv6 system traffic. | ipv6 control-plane [egress filter] | CONFIGURATION |
| Create a Layer 3 ACL using permit rules with the count option to describe the desired CPU traffic | permit ip {source mask any host ip-address} {destination mask any host ip-address} count | CONFIG-NAACL |



Note: The **ip control-plane [egress filter]** and the **ipv6 control-plane [egress filter]** commands are not supported on the S4810 or S4820T systems.

FTOS Behavior: VRRP hellos and IGMP packets are not affected when egress ACL filtering for CPU traffic is enabled. Packets sent by the CPU with the source address as the VRRP virtual IP address have the interface MAC address instead of VRRP virtual MAC address.

Configuring ACLs to Loopback

ACLs can be supplied on Loopback interfaces supported on platform 

Configuring ACLs onto the CPU in a loopback interface protects the system infrastructure from attack—malicious and incidental—by explicate allowing only authorized traffic.

The ACLs on loopback interfaces are applied only to the CPU on the RPM—this eliminates the need to apply specific ACLs onto all ingress interfaces and achieves the same results. By localizing target traffic, it is a simpler implementation.

The ACLs target and handle Layer 3 traffic destined to terminate on the system including routing protocols, remote access, SNMP, ICMP, and etc. Effective filtering of Layer 3 traffic from Layer 3 routers reduces the risk of attack.



Note: Loopback ACLs are supported only on ingress traffic.

Loopback interfaces do not support ACLs using the IP fragment option. If you configure an ACL with the fragments option and apply it to a loopback interface, the command is accepted, but the ACL entries are not actually installed the offending rule in CAM.

See also [Loopback Interfaces](#) in the [Interfaces](#) chapter.

Applying an ACL on Loopback Interfaces

ACLs can be applied on Loopback interfaces supported on platform 

To apply an ACL (standard or extended) for loopback, use these commands in the following sequence:

| Step | Command Syntax | Command Mode | Purpose |
|------|--|---------------|--|
| 1 | interface loopback 0 | CONFIGURATION | Only loopback 0 is supported for the loopback ACL. |
| 2 | ip access-list [standard extended] name | CONFIGURATION | Apply rules to the new ACL. |
| 3 | ip access-group name in | INTERFACE | Apply an ACL to traffic entering loopback. <ul style="list-style-type: none">in: configure the ACL to filter incoming traffic Note: ACLs for loopback can only be applied to incoming traffic. |

To apply ACLs on loopback, use the **ip access-group** command in the INTERFACE mode as shown in the example below. This example also shows the interface configuration status, adding rules to the access group, and displaying the list of rules in the ACL:

```
FTOS(conf)#interface loopback 0
FTOS(conf-if-lo-0)#ip access-group abcd in
FTOS(conf-if-lo-0)#show config
!
interface Loopback 0
  no ip address
  ip access-group abcd in
  no shutdown
FTOS(conf-if-lo-0)#end
FTOS#configure terminal
FTOS(conf)#ip access-list extended abcd
FTOS(config-ext-nacl)#permit tcp any any
FTOS(config-ext-nacl)#deny icmp any any
FTOS(config-ext-nacl)#permit 1.1.1.2
FTOS(config-ext-nacl)#end
FTOS#show ip accounting access-list
!
Extended Ingress IP access list abcd on Loopback 0
seq 5 permit tcp any any
seq 10 deny icmp any any
seq 10 deny icmp any any
permit 1.1.1.2
```



Note: Refer to the section [VTY Line Local Authentication and Authorization](#) in the [Security](#) chapter.

IP Prefix Lists

Prefix Lists are supported on platforms: **C e S**

IP prefix lists control routing policy. An IP prefix list is a series of sequential filters that contain a matching criterion (examine IP route prefix) and an action (permit or deny) to process routes. The filters are processed in sequence so that if a route prefix does not match the criterion in the first filter, the second filter (if configured) is applied. When the route prefix matches a filter, FTOS drops or forwards the packet based on the filter's designated action. If the route prefix does not match any of the filters in the prefix list, the route is dropped (that is, implicit deny).

A route prefix is an IP address pattern that matches on bits within the IP address. The format of a route prefix is A.B.C.D/X where A.B.C.D is a dotted-decimal address and /X is the number of bits that should be matched of the dotted decimal address. For example, in 112.24.0.0/16, the first 16 bits of the address 112.24.0.0 match all addresses between 112.24.0.0 to 112.24.255.255.

Below are some examples that permit or deny filters for specific routes using the **le** and **ge** parameters, where x.x.x.x/x represents a route prefix:

- To deny only /8 prefixes, enter `deny x.x.x.x/x ge 8 le 8`
- To permit routes with the mask greater than /8 but less than /12, enter `permit x.x.x.x/x ge 8 le 12`
- To deny routes with a mask less than /24, enter `deny x.x.x.x/x le 24`
- To permit routes with a mask greater than /20, enter `permit x.x.x.x/x ge 20`

The following rules apply to prefix lists:

- A prefix list without any permit or deny filters allows all routes.
- An “implicit deny” is assumed (that is, the route is dropped) for all route prefixes that do not match a permit or deny filter in a configured prefix list.
- Once a route matches a filter, the filter’s action is applied. No additional filters are applied to the route.

Implementation Information

In FTOS, prefix lists are used in processing routes for routing protocols (for example, RIP, OSPF, and BGP).



Note: The S-Series platform does not support all protocols. It is important to know which protocol you are supporting prior to implementing Prefix-Lists.

Configuration Task List for Prefix Lists

To configure a prefix list, you must use commands in the PREFIX LIST, the ROUTER RIP, ROUTER OSPF, and ROUTER BGP modes. Basically, you create the prefix list in the PREFIX LIST mode, and assign that list to commands in the ROUTER RIP, ROUTER OSPF and ROUTER BGP modes.

The following list includes the configuration tasks for prefix lists:

- [Configure a prefix list](#)
- [Use a prefix list for route redistribution](#)

For a complete listing of all commands related to prefix lists, refer to the *FTOS Command Line Interface Reference* document.

Configure a prefix list

To configure a prefix list, use these commands in the following sequence, starting in the CONFIGURATION mode:

| Step | Command Syntax | Command Mode | Purpose |
|------|---|---------------|---|
| 1 | <code>ip prefix-list prefix-name</code> | CONFIGURATION | Create a prefix list and assign it a unique name. You are in the PREFIX LIST mode. |

| Step | Command Syntax | Command Mode | Purpose |
|------|--|-----------------|--|
| 2 | seq <i>sequence-number</i> { deny permit } <i>ip-prefix</i> [ge <i>min-prefix-length</i>] [le <i>max-prefix-length</i>] | CONFIG-NPREFIXL | Create a prefix list with a sequence number and a deny or permit action. The optional parameters are: <ul style="list-style-type: none"> • ge <i>min-prefix-length</i>: is the minimum prefix length to be matched (0 to 32). • le <i>max-prefix-length</i>: is the maximum prefix length to be matched (0 to 32). |

If you want to forward all routes that do not match the prefix list criteria, you must configure a prefix list filter to permit all routes (**permit 0.0.0.0/0 le 32**). The “permit all” filter should be the last filter in your prefix list. To permit the default route only, enter **permit 0.0.0.0/0**.

The example below illustrates how the **seq** command orders the filters according to the sequence number assigned. In the example, filter 20 was configured before filter 15 and 12, but the **show config** command displays the filters in the correct order.

```
FTOS(conf-nprefixl)#seq 20 permit 0.0.0.0/0 le 32
FTOS(conf-nprefixl)#seq 12 deny 134.23.0.0 /16
FTOS(conf-nprefixl)#seq 15 deny 120.23.14.0 /8 le 16
FTOS(conf-nprefixl)#show config
!
ip prefix-list juba
 seq 12 deny 134.23.0.0/16
 seq 15 deny 120.0.0.0/8 le 16
 seq 20 permit 0.0.0.0/0 le 32
FTOS(conf-nprefixl)#
```

Note the last line in the prefix list Juba contains a “permit all” statement. By including this line in a prefix list, you specify that all routes not matching any criteria in the prefix list are forwarded.

To delete a filter, use the **no seq** *sequence-number* command in the PREFIX LIST mode.

If you are creating a standard prefix list with only one or two filters, you can let FTOS assign a sequence number based on the order in which the filters are configured. The FTOS assigns filters in multiples of five.

To configure a filter without a specified sequence number, use these commands in the following sequence starting in the CONFIGURATION mode:

| Step | Command Syntax | Command Mode | Purpose |
|------|--|---------------|---|
| 1 | ip prefix-list <i>prefix-name</i> | CONFIGURATION | Create a prefix list and assign it a unique name. |

| Step | Command Syntax | Command Mode | Purpose |
|------|--|-----------------|---|
| 2 | <code>{deny permit} ip-prefix [ge min-prefix-length] [le max-prefix-length]</code> | CONFIG-NPREFIXL | Create a prefix list filter with a deny or permit action. The optional parameters are: <ul style="list-style-type: none"> ge <i>min-prefix-length</i>: is the minimum prefix length to be matched (0 to 32). le <i>max-prefix-length</i>: is the maximum prefix length to be matched (0 to 32). |

The example below illustrates a prefix list in which the sequence numbers were assigned by the software. The filters were assigned sequence numbers based on the order in which they were configured (for example, the first filter was given the lowest sequence number). The **show config** command in the PREFIX LIST mode displays the two filters with the sequence numbers 5 and 10.

```
FTOS(conf-nprefixl)#permit 123.23.0.0 /16
FTOS(conf-nprefixl)#deny 133.24.56.0 /8
FTOS(conf-nprefixl)#show conf
!
ip prefix-list awe
 seq 5 permit 123.23.0.0/16
 seq 10 deny 133.0.0.0/8
FTOS(conf-nprefixl)#
```

To delete a filter, enter the **show config** command in the PREFIX LIST mode and locate the sequence number of the filter you want to delete; then use the **no seq sequence-number** command in the PREFIX LIST mode.

To view all configured prefix lists, use either of the following commands in the EXEC mode:

| Command Syntax | Command Mode | Purpose |
|---|----------------|---|
| show ip prefix-list detail [<i>prefix-name</i>] | EXEC Privilege | Show detailed information about configured Prefix lists. |
| show ip prefix-list summary [<i>prefix-name</i>] | EXEC Privilege | Show a table of summarized information about configured Prefix lists. |

```
FTOS>show ip prefix detail
Prefix-list with the last deletion/insertion: filter_ospf
ip prefix-list filter_in:
count: 3, range entries: 3, sequences: 5 - 10
 seq 5 deny 1.102.0.0/16 le 32 (hit count: 0)
 seq 6 deny 2.1.0.0/16 ge 23 (hit count: 0)
 seq 10 permit 0.0.0.0/0 le 32 (hit count: 0)
ip prefix-list filter_ospf:
count: 4, range entries: 1, sequences: 5 - 10
 seq 5 deny 100.100.1.0/24 (hit count: 0)
 seq 6 deny 200.200.1.0/24 (hit count: 0)
 seq 7 deny 200.200.2.0/24 (hit count: 0)
 seq 10 permit 0.0.0.0/0 le 32 (hit count: 0)
```

```

FTOS>
FTOS>show ip prefix summary
Prefix-list with the last deletion/insertion: filter_ospf
ip prefix-list filter_in:
count: 3, range entries: 3, sequences: 5 - 10
ip prefix-list filter_ospf:
count: 4, range entries: 1, sequences: 5 - 10
FTOS>

```

Use a prefix list for route redistribution

To pass traffic through a configured prefix list, you must use the prefix list in a route redistribution command. The prefix list is applied to all traffic redistributed into the routing process and the traffic is either forwarded or dropped depending on the criteria and actions specified in the prefix list.

To apply a filter to routes in RIP (RIP is supported on C and E-Series.), use either of the following commands in the ROUTER RIP mode:

| Command Syntax | Command Mode | Purpose |
|--|-------------------|--|
| router rip | CONFIGURATION | Enter RIP mode |
| distribute-list <i>prefix-list-name</i> in [<i>interface</i>] | CONFIG-ROUTER-RIP | Apply a configured prefix list to incoming routes. You can specify an interface. If you enter the name of a nonexistent prefix list, all routes are forwarded. |
| distribute-list <i>prefix-list-name</i> out [<i>interface</i> connected static ospf] | CONFIG-ROUTER-RIP | Apply a configured prefix list to outgoing routes. You can specify an interface or type of route. If you enter the name of a non-existent prefix list, all routes are forwarded. |

To view the configuration, use the **show config** command in the ROUTER RIP mode as shown in the example below or the **show running-config rip** command in the EXEC mode.

```

FTOS (conf-router_rip) #show config
!
router rip
  distribute-list prefix juba out
  network 10.0.0.0
FTOS (conf-router_rip) #router ospf 34

```

To apply a filter to routes in OSPF, use either of the following commands in the ROUTER OSPF mode:

| Command Syntax | Command Mode | Purpose |
|--------------------|---------------|-----------------|
| router ospf | CONFIGURATION | Enter OSPF mode |

| Command Syntax | Command Mode | Purpose |
|---|--------------------|---|
| distribute-list <i>prefix-list-name</i> in [<i>interface</i>] | CONFIG-ROUTER-OSPF | Apply a configured prefix list to incoming routes. You can specify an interface. If you enter the name of a non-existent prefix list, all routes are forwarded. |
| distribute-list <i>prefix-list-name</i> out [connected rip static] | CONFIG-ROUTER-OSPF | Apply a configured prefix list to incoming routes. You can specify which type of routes are affected. If you enter the name of a non-existent prefix list, all routes are forwarded. |

To view the configuration, use the **show config** command in the ROUTER OSPF mode as shown in the example below or the **show running-config ospf** command in the EXEC mode.

```
FTOS (conf-router_ospf) #show config
!
router ospf 34
 network 10.2.1.1 255.255.255.255 area 0.0.0.1
 distribute-list prefix awe in
FTOS (conf-router_ospf) #
```

ACL Resequencing

ACL Resequencing allows you to re-number the rules and remarks in an access or prefix list. The placement of rules within the list is critical because packets are matched against rules in sequential order. Use Resequencing whenever there is no longer an opportunity to order new rules as desired using current numbering scheme.

For example, [Table 7-3](#) contains some rules that are numbered in increments of 1. No new rules can be placed between these, so apply resequencing to create numbering space, as shown in [Table 7-4](#). In the same example, apply resequencing if more than two rules must be placed between rules 7 and 10.

IPv4 and IPv6 ACLs and prefixes and MAC ACLs can be resequenced. No CAM writes happen as a result of resequencing, so there is no packet loss; the behavior is like Hot-lock ACLs.



Note: ACL Resequencing does not affect the rules or remarks or the order in which they are applied. It merely rennumbers them so that new rules can be placed within the list as desired.

Table 7-3. ACL Resequencing Example (Insert New Rules)

```
seq 5 permit any host 1.1.1.1
seq 6 permit any host 1.1.1.2
```

Table 7-3. ACL Resequencing Example (Insert New Rules)

```
seq 7 permit any host 1.1.1.3
seq 10 permit any host 1.1.1.4
```

Table 7-4. ACL Resequencing Example (Resequenced)

```
seq 5 permit any host 1.1.1.1
seq 10 permit any host 1.1.1.2
seq 15 permit any host 1.1.1.3
seq 20 permit any host 1.1.1.4
```

Resequencing an ACL or Prefix List

Resequencing is available for IPv4 and IPv6 ACLs and prefix lists and MAC ACLs. To resequence an ACL or prefix list use the appropriate command in [Table 7-5](#). You must specify the list name, starting number, and increment when using these commands.

Table 7-5. Resequencing ACLs and Prefix Lists

| List | Command | Command Mode |
|--------------------------|---|--------------|
| IPv4, IPv6, or MAC ACL | <code>resequence access-list {ipv4 ipv6 mac} {access-list-name StartingSeqNum Step-to-Increment}</code> | Exec |
| IPv4 or IPv6 prefix-list | <code>resequence prefix-list {ipv4 ipv6} {prefix-list-name StartingSeqNum Step-to-Increment}</code> | Exec |

The following example shows the resequencing of an IPv4 access-list beginning with the number 2 and incrementing by 2.

```
FTOS(config-ext-nacl)# show config
!
ip access-list extended test
remark 4 XYZ
remark 5 this remark corresponds to permit any host 1.1.1.1
seq 5 permit ip any host 1.1.1.1
remark 9 ABC
remark 10 this remark corresponds to permit ip any host 1.1.1.2
seq 10 permit ip any host 1.1.1.2
seq 15 permit ip any host 1.1.1.3
seq 20 permit ip any host 1.1.1.4
FTOS# end
FTOS# resequence access-list ipv4 test 2 2
FTOS# show running-config acl
```

```

!
ip access-list extended test
remark 2 XYZ
remark 4 this remark corresponds to permit any host 1.1.1.1
seq 4 permit ip any host 1.1.1.1
remark 6 this remark has no corresponding rule
remark 8 this remark corresponds to permit ip any host 1.1.1.2
seq 8 permit ip any host 1.1.1.2
seq 10 permit ip any host 1.1.1.3
seq 12 permit ip any host 1.1.1.4

```

Remarks and rules that originally have the same sequence number have the same sequence number after the resequence command is applied. Remarks that do not have a corresponding rule will be incremented as a rule. These two mechanisms allow remarks to retain their original position in the list.

For example, in the following example, remark 10 corresponds to rule 10 and as such, they have the same number before and after the command is entered. Remark 4 is incremented as a rule, and all rules have retained their original positions.

```

FTOS(config-ext-nacl)# show config
!
ip access-list extended test
remark 4 XYZ
remark 5 this remark corresponds to permit any host 1.1.1.1
seq 5 permit ip any host 1.1.1.1
remark 9 ABC
remark 10 this remark corresponds to permit ip any host 1.1.1.2
seq 10 permit ip any host 1.1.1.2
seq 15 permit ip any host 1.1.1.3
seq 20 permit ip any host 1.1.1.4
FTOS# end
FTOS# resequence access-list ipv4 test 2 2
FTOS# show running-config acl
!
ip access-list extended test
remark 2 XYZ
remark 4 this remark corresponds to permit any host 1.1.1.1
seq 4 permit ip any host 1.1.1.1
remark 6 this remark has no corresponding rule
remark 8 this remark corresponds to permit ip any host 1.1.1.2
seq 8 permit ip any host 1.1.1.2
seq 10 permit ip any host 1.1.1.3
seq 12 permit ip any host 1.1.1.4

```

Route Maps

Route-maps are supported on platforms: **C e S**

Like ACLs and prefix lists, route maps are composed of a series of commands that contain a matching criterion and an action, yet route maps can change the packets meeting the criterion. ACLs and prefix lists can only drop or forward the packet or traffic. Route maps process routes for route redistribution. For example, a route map can be called to filter only specific routes and to add a metric.

Route maps also have an “implicit deny.” Unlike ACLs and prefix lists, however, where the packet or traffic is dropped, in route maps, if a route does not match any of the route map conditions, the route is not redistributed.

Implementation Information

The FTOS implementation of route maps allows route maps with no match command or no set command. When there is no match command, all traffic matches the route map and the set command applies.

Important Points to Remember

- For route-maps with more than one match clause:
 - Two or more match clauses within the same route-map sequence have the *same* match commands (though the values are different), matching a packet against these clauses is a logical OR operation.
 - Two or more match clauses within the same route-map sequence have *different* match commands, matching a packet against these clauses is a logical AND operation.
- If no match is found in a route-map sequence, the process moves to the next route-map sequence until a match is found, or there are no more sequences.
- When a match is found, the packet is forwarded; no more route-map sequences are processed.
 - If a continue clause is included in the route-map sequence, the next or a specified route-map sequence is processed after a match is found.

Configuration Task List for Route Maps

You configure route maps in the ROUTE-MAP mode and apply them in various commands in the ROUTER RIP and ROUTER OSPF modes.

The following list includes the configuration tasks for route maps:

- [Create a route map](#) (mandatory)
- [Configure route map filters](#) (optional)
- [Configure a route map for route redistribution](#) (optional)
- [Configure a route map for route tagging](#) (optional)

Create a route map

Route maps, ACLs, and prefix lists are similar in composition because all three contain filters, but route map filters do not contain the permit and deny actions found in ACLs and prefix lists. Route map filters match certain routes and set or specify values.

To create a route map and enter the ROUTE-MAP mode, use the following command in the CONFIGURATION mode:

| Command Syntax | Command Mode | Purpose |
|--|---------------|---|
| route-map <i>map-name</i> [permit deny] [<i>sequence-number</i>] | CONFIGURATION | Create a route map and assign it a unique name. The optional permit and deny keywords are the action of the route map. The default is permit . The optional parameter seq allows you to assign a sequence number to the route map instance. |

The default action is permit and the default sequence number starts at 10. When the keyword **deny** is used in configuring a route map, routes that meet the match filters are not redistributed.

To view the configuration, use the **show config** command in the ROUTE-MAP mode as shown in the example below.

```
FTOS(config-route-map)#show config
!  
route-map dilling permit 10  
FTOS(config-route-map)#
```

You can create multiple instances of this route map by using the sequence number option to place the route maps in the correct order. FTOS processes the route maps with the lowest sequence number first. When a configured route map is applied to a command, like **redistribute**, traffic passes through all instances of that route map until a match is found. The following text shows an example with two instances of a route map.

```
FTOS#show route-map  
route-map zakho, permit, sequence 10  
  Match clauses:  
  Set clauses:  
route-map zakho, permit, sequence 20  
  Match clauses:  
  interface GigabitEthernet 0/1  
  Set clauses:  
  tag 35  
  level stub-area  
FTOS#
```

To delete all instances of that route map, use the **no route-map** *map-name* command. To delete just one instance, add the sequence number to the command syntax as shown in the following example.

```
FTOS(conf)#no route-map zakho 10  
FTOS(conf)#end
```

```

FTOS#show route-map
route-map zakho, permit, sequence 20
  Match clauses:
    interface GigabitEthernet 0/1
  Set clauses:
    tag 35
    level stub-area
FTOS#

```

The following text shows an example of a route map with multiple instances. The **show config** command displays only the configuration of the current route map instance. To view all instances of a specific route map, use the **show route-map** command.

```

FTOS#show route-map dilling
route-map dilling, permit, sequence 10
  Match clauses:
  Set clauses:
route-map dilling, permit, sequence 15
  Match clauses:
    interface Loopback 23
  Set clauses:
    tag 3444
FTOS#

```

To delete a route map, use the **no route-map** *map-name* command in the CONFIGURATION mode.

Configure route map filters

Within the ROUTE-MAP mode, there are **match** and **set** commands. Basically, **match** commands search for a certain criterion in the routes and the **set** commands change the characteristics of those routes, either adding something or specifying a level.

When there are multiple match commands of the same parameter under one instance of route-map, then FTOS does a match between either of those match commands. If there are multiple match commands of different parameter, then FTOS does a match ONLY if there is a match among ALL match commands. The following example explains better:

Example 1

```

FTOS(conf)#route-map force permit 10
FTOS(config-route-map)#match tag 1000
FTOS(config-route-map)#match tag 2000
FTOS(config-route-map)#match tag 3000

```

In the above route-map, if a route has any of the tag value specified in the match commands, then there is a match.

Example 2

```

FTOS(conf)#route-map force permit 10
FTOS(config-route-map)#match tag 1000

```

```
FTOS(config-route-map)#match metric 2000
```

In the above route-map, *only* if a route has *both* the characteristics mentioned in the route-map, it is matched. Explaining further, the route *must* have a tag value of 1000 *and* a metric value of 2000. Only then is there a match.

Also, if there are different instances of the same route-map, then it's sufficient if a permit match happens in *any* instance of that route-map. As an example:

```
FTOS(conf)#route-map force permit 10
FTOS(config-route-map)#match tag 1000
```

```
FTOS(conf)#route-map force deny 20
FTOS(config-route-map)#match tag 1000
```

```
FTOS(conf)#route-map force deny 30
FTOS(config-route-map)#match tag 1000
```

In the above route-map, instance 10 permits the route having a tag value of 1000 and instances 20 & 30 denies the route having a tag value of 1000. In the above scenario, FTOS scans all the instances of the route-map for any permit statement. If there is a match anywhere, the route is permitted, though other instances of the route-map denies it.

To configure match criterion for a route map, use any or all of the following commands in the ROUTE-MAP mode:

| Command Syntax | Command Mode | Purpose |
|---|------------------|--|
| match as-path <i>as-path-name</i> | CONFIG-ROUTE-MAP | Match routes with the same AS-PATH numbers. |
| match community <i>community-list-name</i> [exact] | CONFIG-ROUTE-MAP | Match routes with COMMUNITY list attributes in their path. |

| Command Syntax | Command Mode | Purpose |
|--|------------------|--|
| match interface <i>interface</i> | CONFIG-ROUTE-MAP | Match routes whose next hop is a specific interface. The parameters are: <ul style="list-style-type: none"> For a Fast Ethernet interface, enter the keyword FastEthernet followed by the slot/port information. For a 1-Gigabit Ethernet interface, enter the keyword gigabitEthernet followed by the slot/port information. For a loopback interface, enter the keyword loopback followed by a number between zero (0) and 16383. For a port channel interface, enter the keyword port-channel followed by a number from 1 to 255 for TeraScale and ExaScale, 1 to 32 for EtherScale. For a SONET interface, enter the keyword sonet followed by the slot/port information. For a 10-Gigabit Ethernet interface, enter the keyword tengigabitEthernet followed by the slot/port information. For a VLAN, enter the keyword vlan followed by a number from 1 to 4094. For a 40-Gigabit Ethernet interface, enter the keyword fortyGigE followed by the slot/port information. |
| match ip address <i>prefix-list-name</i> | CONFIG-ROUTE-MAP | Match destination routes specified in a prefix list (IPv4). |
| match ipv6 address <i>prefix-list-name</i> | CONFIG-ROUTE-MAP | Match destination routes specified in a prefix list (IPv6). |
| match ip next-hop { <i>access-list-name</i> prefix-list <i>prefix-list-name</i> } | CONFIG-ROUTE-MAP | Match next-hop routes specified in a prefix list (IPv4). |
| match ipv6 next-hop { <i>access-list-name</i> prefix-list <i>prefix-list-name</i> } | CONFIG-ROUTE-MAP | Match next-hop routes specified in a prefix list (IPv6). |
| match ip route-source { <i>access-list-name</i> prefix-list <i>prefix-list-name</i> } | CONFIG-ROUTE-MAP | Match source routes specified in a prefix list (IPv4). |
| match ipv6 route-source { <i>access-list-name</i> prefix-list <i>prefix-list-name</i> } | CONFIG-ROUTE-MAP | Match source routes specified in a prefix list (IPv6). |
| match metric <i>metric-value</i> | CONFIG-ROUTE-MAP | Match routes with a specific value. |
| match origin { egp igp incomplete } | CONFIG-ROUTE-MAP | Match BGP routes based on the ORIGIN attribute. |
| match route-type { external [type-1 type-2] internal level-1 level-2 local } | CONFIG-ROUTE-MAP | Match routes specified as internal or external to OSPF, ISIS level-1, ISIS level-2, or locally generated. |

| Command Syntax | Command Mode | Purpose |
|-----------------------------------|------------------|-----------------------------------|
| match tag <i>tag-value</i> | CONFIG-ROUTE-MAP | Match routes with a specific tag. |

To configure a set condition, use any or all of the following commands in the ROUTE-MAP mode:

| Command Syntax | Command Mode | Purpose |
|---|------------------|--|
| set as-path prepend <i>as-number</i> [... <i>as-number</i>] | CONFIG-ROUTE-MAP | Add an AS-PATH number to the beginning of the AS-PATH |
| set automatic-tag | CONFIG-ROUTE-MAP | Generate a tag to be added to redistributed routes. |
| set level {backbone level-1 level-1-2 level-2 stub-area} | CONFIG-ROUTE-MAP | Specify an OSPF area or ISIS level for redistributed routes. |
| set local-preference <i>value</i> | CONFIG-ROUTE-MAP | Specify a value for the BGP route's LOCAL_PREF attribute. |
| set metric {+ - <i>metric-value</i> } | CONFIG-ROUTE-MAP | Specify a value for redistributed routes. |
| set metric-type {external internal type-1 type-2} | CONFIG-ROUTE-MAP | Specify an OSPF or ISIS type for redistributed routes. |
| set next-hop <i>ip-address</i> | CONFIG-ROUTE-MAP | Assign an IP address as the route's next hop. |
| set ipv6 next-hop <i>ip-address</i> | CONFIG-ROUTE-MAP | Assign an IPv6 address as the route's next hop. |
| set origin {egp igp incomplete} | CONFIG-ROUTE-MAP | Assign an ORIGIN attribute. |
| set tag <i>tag-value</i> | CONFIG-ROUTE-MAP | Specify a tag for the redistributed routes. |
| set weight <i>value</i> | CONFIG-ROUTE-MAP | Specify a value as the route's weight. |

Use these commands to create route map instances. There is no limit to the number of set and match commands per route map, but the convention is to keep the number of match and set filters in a route map low. **Set** commands do not require a corresponding **match** command.

Configure a route map for route redistribution

Route maps on their own cannot affect traffic and must be included in different commands to affect routing traffic. To apply a route map to traffic on the E-Series, you must call or include that route map in a command such as the **redistribute** or **default-information originate** commands in OSPF, ISIS, and BGP.

Route redistribution occurs when FTOS learns the advertising routes from static or directly connected routes or another routing protocol. Different protocols assign different values to redistributed routes to identify either the routes and their origins. The metric value is the most common attribute that is changed to properly redistribute other routes into a routing protocol. Other attributes that can be changed include the metric type (for example, external and internal route types in OSPF) and route tag. Use the **redistribute** command in OSPF, RIP, ISIS, and BGP to set some of these attributes for routes that are redistributed into those protocols.

Route maps add to that redistribution capability by allowing you to match specific routes and set or change more attributes when redistributing those routes.

In the following example, the **redistribute** command calls the route map `static ospf` to redistribute only certain static routes into OSPF. According to the route map `static ospf`, only routes that have a next hop of GigabitEthernet interface 0/0 and that have a metric of 255 will be redistributed into the OSPF backbone area.



Note: When re-distributing routes using route-maps, the user must take care to create the route-map defined in the **redistribute** command under the routing protocol. If no route-map is created, then NO routes are redistributed.

```
router ospf 34
  default-information originate metric-type 1
  redistribute static metric 20 metric-type 2 tag 0 route-map staticospf
!
route-map staticospf permit 10
  match interface GigabitEthernet 0/0
  match metric 255
  set level backbone
```

Configure a route map for route tagging

One method for identifying routes from different routing protocols is to assign a tag to routes from that protocol. As the route enters a different routing domain, it is tagged and that tag is passed along with the route as it passes through different routing protocols. This tag can then be used when the route leaves a routing domain to redistribute those routes again.

In the following example, the **redistribute ospf** command with a route map is used in the ROUTER RIP mode to apply a tag of 34 to all internal OSPF routes that are redistributed into RIP.

```
!
router rip
  redistribute ospf 34 metric 1 route-map torip
!
route-map torip permit 10
  match route-type internal
  set tag 34
!
```

Continue clause

Normally, when a match is found, set clauses are executed, and the packet is then forwarded; no more route-map modules are processed. If the **continue** command is configured at the end of a module, the next module (or a specified module) is processed even after a match is found. The following example shows a continue clause at the end of a route-map module. In this example, if a match is found in the route-map “test” module 10, module 30 will be processed.



Note: If the continue clause is configured without specifying a module, the next sequential module is processed.

```
!  
route-map test permit 10  
match commu comm-list1  
set community 1:1 1:2 1:3  
set as-path prepend 1 2 3 4 5  
continue 30!
```

Bidirectional Forwarding Detection (BFD)

Bidirectional Forwarding Detection (BFD) is supported only on platforms: e C **S4810** and **S4820T**

Protocol Overview

Bidirectional Forwarding Detection (BFD) is a protocol that is used to rapidly detect communication failures between two adjacent systems. It is a simple and lightweight replacement for existing routing protocol link state detection mechanisms. It also provides a failure detection solution for links on which no routing protocol is used.

BFD is a simple hello mechanism. Two neighboring systems running BFD establish a session using a three-way handshake. After the session has been established, the systems exchange periodic control packets at sub-second intervals. If a system does not receive a hello packet within a specified amount of time, routing protocols are notified that the forwarding path is down.

BFD provides forwarding path failure detection times on the order of milliseconds rather than seconds as with conventional routing protocol hellos. It is independent of routing protocols, and as such provides a consistent method of failure detection when used across a network. Networks converge faster because BFD triggers link state changes in the routing protocol sooner and more consistently, because BFD can eliminate the use of multiple protocol-dependent timers and methods.

BFD also carries less overhead than routing protocol hello mechanisms. Control packets can be encapsulated in any form that is convenient, and, on Dell Force10 routers, sessions are maintained by BFD Agents that reside on the line card, which frees resources on the RPM. Only session state changes are reported to the BFD Manager (on the RPM), which in turn notifies the routing protocols that are registered with it.

BFD is an independent and generic protocol, which all media, topologies, and routing protocols can support using any encapsulation. Dell Force10 has implemented BFD at Layer 3 and with UDP encapsulation. BFD functionality will be implemented in phases. The C-Series and E-Series support BFD on OSPF, IS-IS, VLANs, VRRP, LAGs, and physical ports based on the IETF internet draft document *draft-ietf-bfd-base-03*. On the S4810 and S4820T, BFD is supported on dynamic routing protocols such as OSPF, IS-IS and BGP.

How BFD Works

Two neighboring systems running BFD establish a session using a three-way handshake. After the session has been established, the systems exchange control packets at agreed upon intervals. In addition, systems send a control packet anytime there is a state change or change in a session parameter; these control packets are sent without regard to transmit and receive intervals.



Note: FTOS does not support multi-hop BFD sessions.

If a system does not receive a control packet within an agreed-upon amount of time, the BFD Agent changes the session state to Down. It then notifies the BFD Manager of the change, and sends a control packet to the neighbor that indicates the state change (though it might not be received if the link or receiving interface is faulty). The BFD Manager notifies the routing protocols that are registered with it (clients) that the forwarding path is down, and a link state change is triggered in all protocols.



Note: A session state change from Up to Down is the only state change that triggers a link state change in the routing protocol client.

BFD packet format

Control packets are encapsulated in UDP packets. The following illustration shows the complete encapsulation of a BFD control packet inside an IPv4 packet.

Figure 8-1. BFD in IPv4 Packet Format

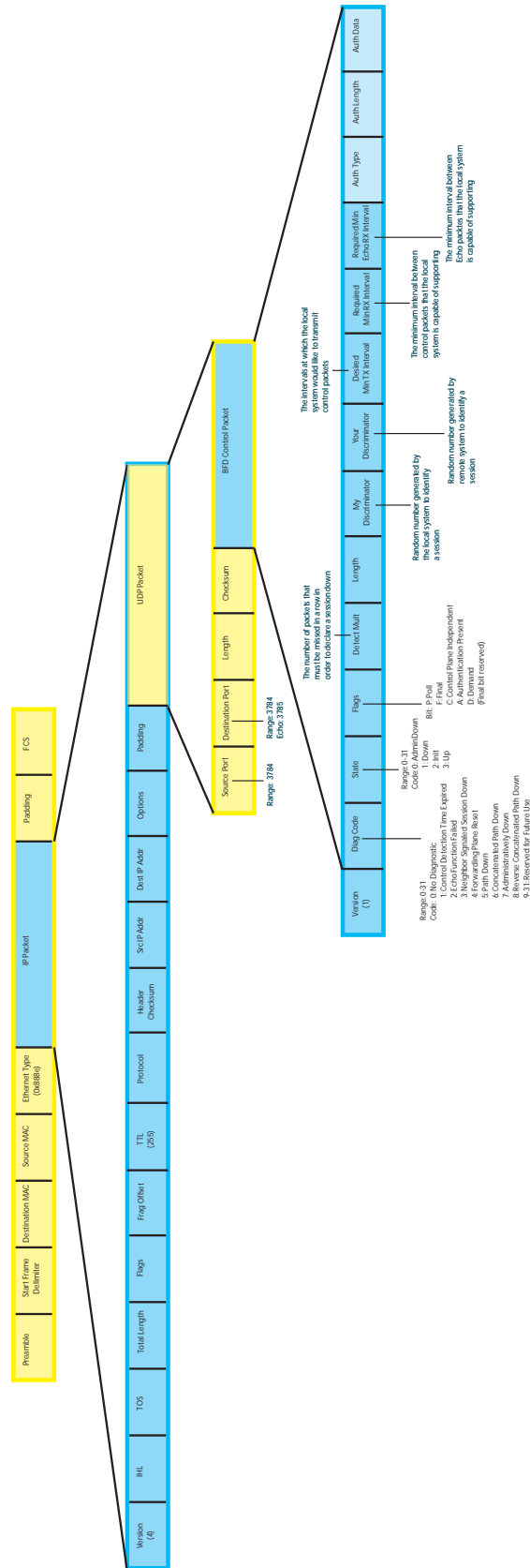

Table 8-1. BFD Packet Fields

| Field | Description |
|--------------------------|---|
| Diagnostic Code | The reason that the last session failed. |
| State | The current local session state. See BFD sessions . |
| Flag | A bit that indicates packet function. If the poll bit is set, the receiving system must respond as soon as possible, without regard to its transmit interval. The responding system clears the poll bit and sets the final bit in its response. The poll and final bits are used during the handshake and Demand mode (see BFD sessions). Note: FTOS does not currently support multi-point sessions, Demand mode, authentication, or control plane independence; these bits are always clear. |
| Detection Multiplier | The number of packets that must be missed in order to declare a session down. |
| Length | The entire length of the BFD packet. |
| My Discriminator | A random number generated by the local system to identify the session. |
| Your Discriminator | A random number generated by the remote system to identify the session. Discriminator values are necessary to identify the session to which a control packet belongs since there can be many sessions running on a single interface. |
| Desired Min TX Interval | The minimum rate at which the local system would like to send control packets to the remote system. |
| Required Min RX Interval | The minimum rate at which the local system would like to receive control packets from the remote system. |
| Required Min Echo RX | The minimum rate at which the local system would like to receive echo packets. Note: FTOS does not currently support the echo function. |
| Authentication Type | An optional method for authenticating control packets. Note: FTOS does not currently support the BFD authentication function. |
| Authentication Length | |
| Authentication Data | |

Two important parameters are calculated using the values contained in the control packet.

- **Transmit interval** — Transmit interval is the agreed-upon rate at which a system sends control packets. Each system has its own transmit interval, which is the greater of the last received remote Desired TX Interval and the local Required Min RX Interval.
- **Detection time** — Detection time is the amount of time that a system does not receive a control packet, after which the system determines that the session has failed. Each system has its own detection time.
 - In Asynchronous mode: Detection time is the remote Detection Multiplier multiplied by greater of the remote Desired TX Interval and the local Required Min RX Interval.
 - In Demand mode: Detection time is the local Detection Multiplier multiplied by the greater of the local Desired Min TX and the remote Required Min RX Interval.

BFD sessions

BFD must be enabled on both sides of a link in order to establish a session. The two participating systems can assume either of two roles:

- **Active**—The active system initiates the BFD session. Both systems can be active for the same session.
- **Passive**—The passive system does not initiate a session. It only responds to a request for session initialization from the active system.

A BFD session has two modes:

- **Asynchronous mode**—In Asynchronous mode, both systems send periodic control messages at an agreed upon interval to indicate that their session status is Up.
- **Demand mode**—If one system requests Demand mode, the other system stops sending periodic control packets; it only sends a response to status inquiries from the Demand mode initiator. Either system (but not both) can request Demand mode at any time.



Note: FTOS supports asynchronous mode only.

A session can have four states: Administratively Down, Down, Init, and Up.

- **Administratively Down**—The local system will not participate in a particular session.
- **Down**—The remote system is not sending any control packets or at least not within the detection time for a particular session.
- **Init**—The local system is communicating.
- **Up**—The both systems are exchanging control packets.

The session is declared down if:

- A control packet is not received within the detection time.
- Sufficient echo packets are lost.
- Demand mode is active and a control packet is not received in response to a poll packet.

BFD three-way handshake

A three-way handshake must take place between the systems that will participate in the BFD session. The handshake shown in the illustration below assumes that there is one active and one passive system, and that this is the first session established on this link. The default session state on both ports is Down.

1. The active system sends a steady stream of control packets that indicates that its session state is Down, until the passive system responds. These packets are sent at the desired transmit interval of the Active system, and the Your Discriminator field is set to zero.
2. When the passive system receives any of these control packets, it changes its session state to Init, and sends a response that indicates its state change. The response includes its session ID in the My Discriminator field, and the session ID of the remote system in the Your Discriminator field.
3. The active system receives the response from the passive system, and changes its session state to Up. It then sends a control packet indicating this state change. This is the third and final part of the handshake. At this point, the discriminator values have been exchanged, and the transmit intervals have been negotiated.

- The passive system receives the control packet, changes its state to Up. Both systems agree that a session has been established. However, since both members must send a control packet—that requires a response—anytime there is a state change or change in a session parameter, the passive system sends a final response indicating the state change. After this, periodic control packets are exchanged.

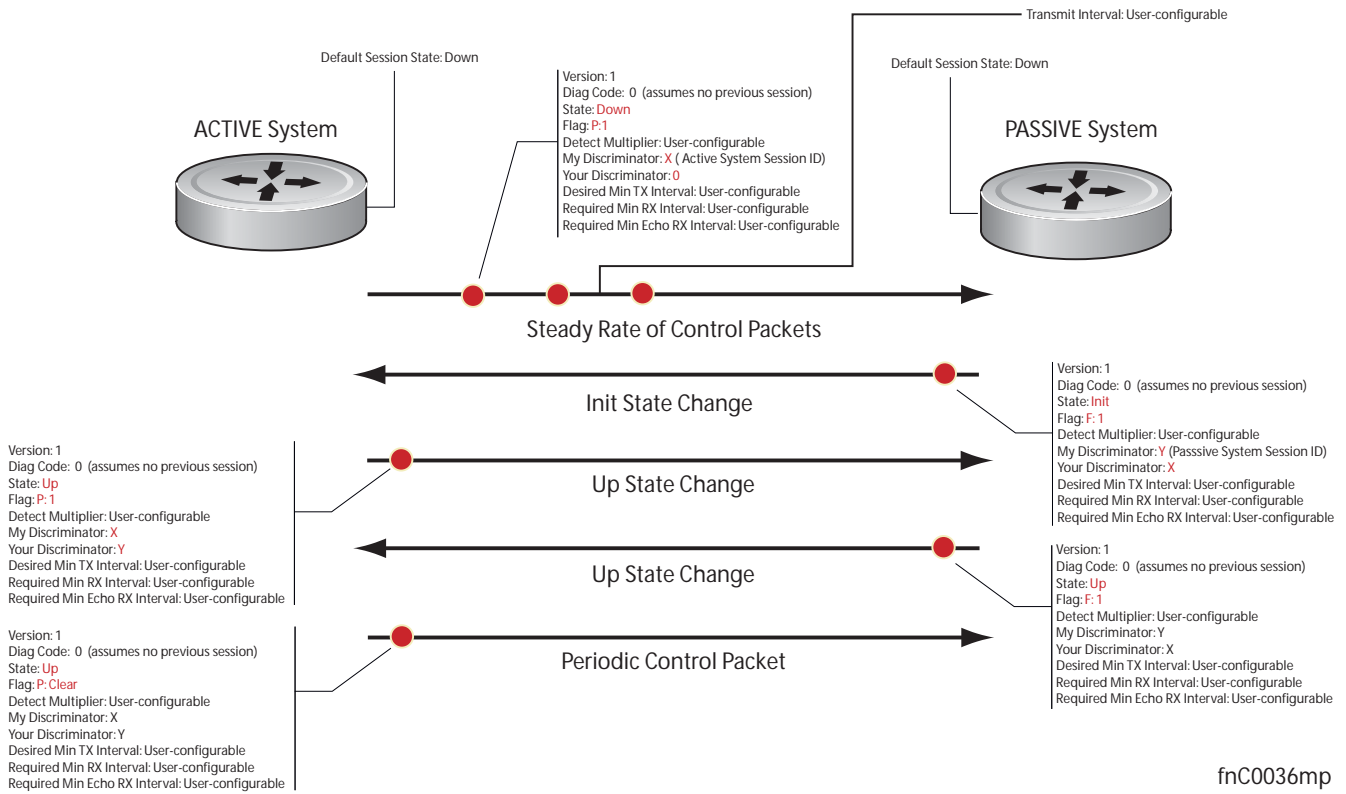

Session state changes

The illustration below shows how the session state on a system changes based on the status notification it receives from the remote system. For example, if a session on a system is down, and it receives a Down status notification from the remote system, the session state on the local system changes to Init.

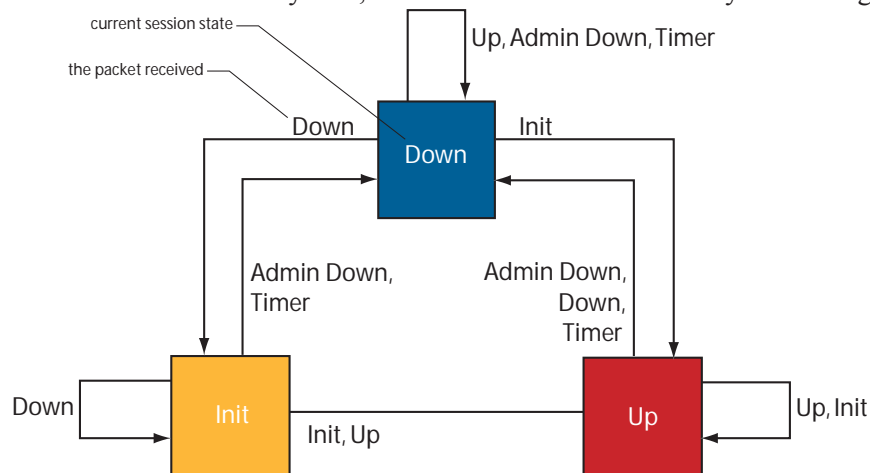

Important Points to Remember

- BFD for line card ports is hitless, but is not hitless for VLANs since they are instantiated on the RPM.
- FTOS supports a maximum of 100 sessions per BFD agent on C-Series and E-Series. Each linecard processor has a BFD Agent, so the limit translates to 100 BFD sessions per linecard (plus, on the E-Series, 100 BFD sessions on RP2, which handles LAG and VLANs). On the S4810 and S4820T, FTOS supports 128 sessions per stack unit at 200 minimum transmit and receive intervals with a multiplier of 3, and 64 sessions at 100 minimum transmit and receive intervals with a multiplier of 4.
- BFD must be enabled on both ends of a link.
- Demand mode, authentication, and the Echo function are not supported.
- BFD is not supported on multi-hop and virtual links.
- Protocol Liveness is supported for routing protocols only.
- FTOS supports only OSPF, IS-IS, (E-Series **S4810** and **S4820T** only), BGP (**S4810** and **S4820T** only), and VRRP (not on **S4810** or **S4820T**) protocols as BFD clients.

Configuring Bidirectional Forwarding Detection

The remainder of this chapter is divided into the following sections:

- [Configuring BFD for Physical Ports](#)
- [Configuring BFD for Static Routes](#)
- [Configuring BFD for OSPF](#)
- [Configuring BFD for IS-IS](#)
- [Configuring BFD for BGP](#)
- [Configuring BFD for VRRP](#)
- [Configuring BFD for VLANs](#)
- [Configuring BFD for Port-Channels](#)
- [Configuring Protocol Liveness](#)
- [Troubleshooting BFD](#)

Configuring BFD for Physical Ports

Configuring BFD for Physical Ports is supported on C-Series and E-Series only.

BFD on physical ports is useful when no routing protocol is enabled. Without BFD, if the remote system fails, the local system does not remove the connected route until the first failed attempt to send a packet. When BFD is enabled, the local system removes the route as soon as it stops receiving periodic control packets from the remote system.

Configuring BFD for a physical port is a two-step process:

1. [Enabling BFD globally.](#)

2. Establish a session with a next-hop neighbor.

Related configuration tasks

- [Viewing physical port session parameters.](#)
- [Disabling and re-enabling BFD.](#)

Enabling BFD globally

BFD must be enabled globally on both routers, as shown in the illustration in [Establishing a session on physical ports](#).

To enable BFD globally:

| Step | Task | Command Syntax | Command Mode |
|------|----------------------|----------------|---------------|
| 1 | Enable BFD globally. | bfd enable | CONFIGURATION |

Verify that BFD is enabled globally using the command `show running bfd`, as shown in the example below.

```
R1(conf)#bfd ?
enable                Enable BFD protocol
protocol-liveness     Enable BFD protocol-liveness
R1(conf)#bfd enable

R1(conf)#do show running-config bfd
!
bfd enable
R1(conf)#
```

Establishing a session on physical ports

To establish a session, BFD must be enabled at interface level on both ends of the link, as shown in the illustration below. The configuration parameters do not need to match.

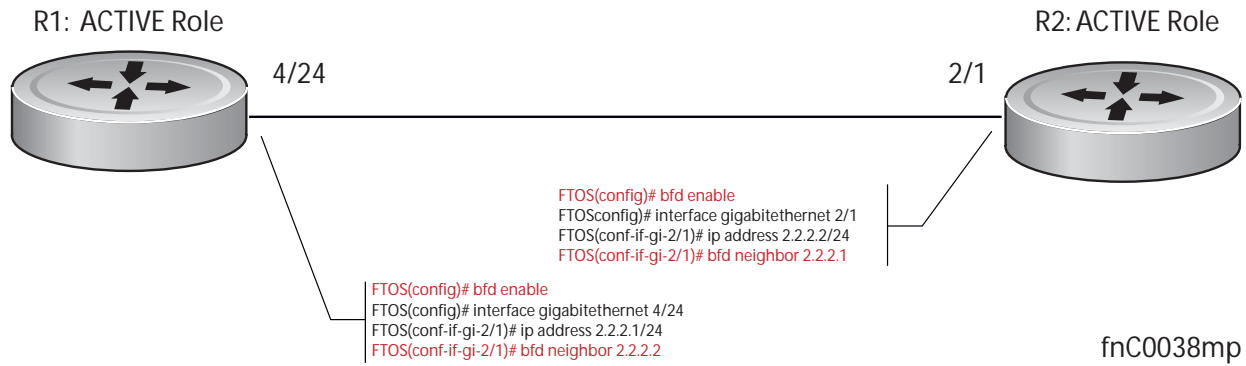

To establish a session:

| Step | Task | Command Syntax | Command Mode |
|------|---|------------------------------|---------------|
| 1 | Enter interface mode | interface | CONFIGURATION |
| 2 | Assign an IP address to the interface if one is not already assigned. | ip address <i>ip-address</i> | INTERFACE |

Verify that the session is established using the command `show bfd neighbors`, as shown in the example below.

```
R1(conf-if-gi-4/24)#do show bfd neighbors
*      - Active session role
Ad Dn  - Admin Down
C      - CLI
I      - ISIS
O      - OSPF
R      - Static Route (RTM)

  LocalAddr      RemoteAddr      Interface State Rx-int Tx-int Mult Clients
* 2.2.2.1        2.2.2.2        Gi 4/24   Up    100   100   3    C
```

The example below for the command `show bfd neighbors detail` shows more specific information about BFD sessions.

```
R1(conf-if-gi-4/24)#do show bfd neighbors detail

Session Discriminator: 1
Neighbor Discriminator: 1
Local Addr: 2.2.2.1
Local MAC Addr: 00:01:e8:09:c3:e5
Remote Addr: 2.2.2.2
Remote MAC Addr: 00:01:e8:06:95:a2
Int: GigabitEthernet 4/24
State: Up
Configured parameters:
```

```

TX: 100ms, RX: 100ms, Multiplier: 3
Neighbor parameters:
TX: 100ms, RX: 100ms, Multiplier: 3
Actual parameters:
TX: 100ms, RX: 100ms, Multiplier: 3
Role: Active
Delete session on Down: False
Client Registered: CLI
Uptime: 00:03:57
Statistics:
Number of packets received from neighbor: 1775
Number of packets sent to neighbor: 1775
Number of state changes: 1
Number of messages from IFA about port state change: 0
Number of messages communicated b/w Manager and Agent: 4

```

When both interfaces are configured for BFD, log messages are displayed indicating state changes, as shown in [Message 1](#).

Message 1 BFD Session State Changes

```

R1(conf-if-gi-4/24)#00:36:01: %RPM0-P:RP2 %BFDMGR-1-BFD_STATE_CHANGE: Changed session state to
Down for neighbor 2.2.2.2 on interface Gi 4/24 (diag: 0)
00:36:02: %RPM0-P:RP2 %BFDMGR-1-BFD_STATE_CHANGE: Changed session state to Up for neighbor
2.2.2.2 on interface Gi 4/24 (diag: 0)

```

Viewing physical port session parameters

BFD sessions are configured with default intervals and a default role (active). Dell Force10 recommends maintaining the default values.

View session parameters using the `show bfd neighbors detail` command.

```

R1(conf-if-gi-4/24)#bfd interval 100 min_rx 100 multiplier 4 role passive
R1(conf-if-gi-4/24)#do show bfd neighbors detail

```

```

Session Discriminator: 1
Neighbor Discriminator: 1
Local Addr: 2.2.2.1
Local MAC Addr: 00:01:e8:09:c3:e5
Remote Addr: 2.2.2.2
Remote MAC Addr: 00:01:e8:06:95:a2
Int: GigabitEthernet 4/24
State: Up
Configured parameters:
TX: 100ms, RX: 100ms, Multiplier: 4
Neighbor parameters:
TX: 100ms, RX: 100ms, Multiplier: 3
Actual parameters:
TX: 100ms, RX: 100ms, Multiplier: 4
Role: Passive

```

```

Delete session on Down: False
Client Registered: CLI
Uptime: 00:09:06
Statistics:
  Number of packets received from neighbor: 4092
  Number of packets sent to neighbor: 4093
  Number of state changes: 1
  Number of messages from IFA about port state change: 0
  Number of messages communicated b/w Manager and Agent: 7

```

Disabling and re-enabling BFD

BFD is enabled on all interfaces by default, though sessions are not created unless explicitly configured. If BFD is disabled, all of the sessions on that interface are placed in an Administratively Down state ([Message 2](#)), and the remote systems are notified of the session state change ([Message 3](#)).

To disable BFD on an interface:

| Step | Task | Command Syntax | Command Mode |
|------|------------------------------|----------------|--------------|
| 1 | Disable BFD on an interface. | no bfd enable | INTERFACE |

Message 2 Disabling BFD on a Local Interface

```

R1(conf-if-gi-4/24)#01:00:52: %RPM0-P:RP2 %BFDMGR-1-BFD_STATE_CHANGE: Changed session state to Ad
Dn for neighbor 2.2.2.2 on interface Gi 4/24 (diag: 0)

```

Message 3 Remote System State Change due to Local State Admin Down

```

R2>01:32:53: %RPM0-P:RP2 %BFDMGR-1-BFD_STATE_CHANGE: Changed session state to Down for neighbor
2.2.2.1 on interface Gi 2/1 (diag: 7)

```

To re-enable BFD on an interface:

| Step | Task | Command Syntax | Command Mode |
|------|-----------------------------|----------------|--------------|
| 1 | Enable BFD on an interface. | bfd enable | INTERFACE |

Configuring BFD for Static Routes

Configuring BFD for Static Routes is supported on C-Series and E-Series only.

BFD gives systems a link state detection mechanism for static routes. With BFD, systems are notified to remove static routes from the routing table as soon as the link state change occurs, rather than having to wait until packets fail to reach their next hop.

Configuring BFD for static routes is a three-step process:

1. [Enabling BFD globally.](#)
2. On the local system, establish a session with the next hop of a static route. Refer to [Configuring BFD for Static Routes](#).
3. On the remote system, establish a session with the physical port that is the origin of the static route. Refer to [Establishing a session on physical ports](#).

Related configuration tasks

- [Changing static route session parameters.](#)
- [Disabling BFD for static routes.](#)

Establishing sessions for static routes

Sessions are established for all neighbors that are the next hop of a static route.

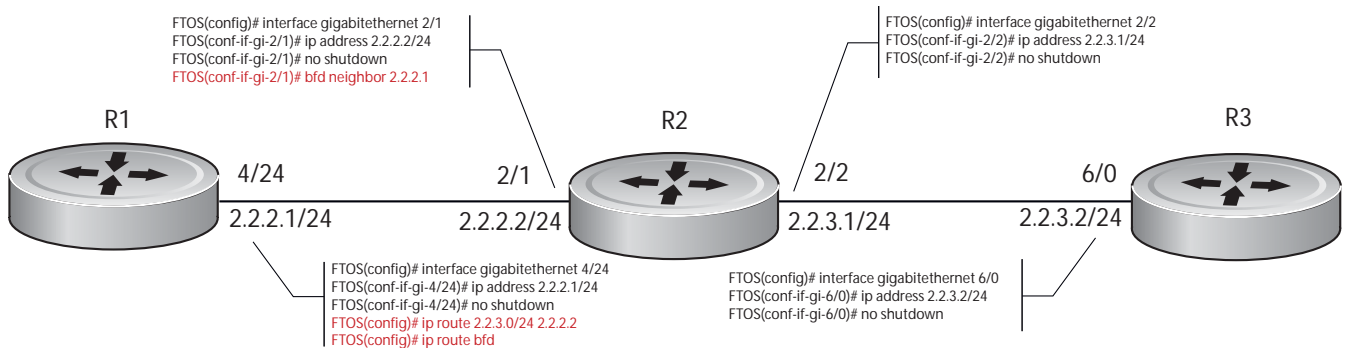

fnC0039mp

To establish a BFD session:

| Step | Task | Command Syntax | Command Mode |
|------|---|---------------------------|---------------|
| 1 | Establish BFD sessions for all neighbors that are the next hop of a static route. | <code>ip route bfd</code> | CONFIGURATION |

Verify that sessions have been created for static routes using the command `show bfd neighbors`, as shown in the example below.

```
R1(conf)#ip route 2.2.3.0/24 2.2.2.2
R1(conf)#ip route bfd
R1(conf)#do show bfd neighbors
```

```
*          - Active session role
Ad Dn     - Admin Down
C         - CLI
```

I - ISIS
 O - OSPF
 R - Static Route (RTM)

```

LocalAddr      RemoteAddr      Interface State Rx-int Tx-int Mult Clients
2.2.2.1        2.2.2.2        Gi 4/24  Up    100   100   4      R

```

View detailed session information using the command `show bfd neighbors detail`, as shown in the example in [Verifying BFD sessions with BGP neighbors using show bfd neighbors detail](#).

Changing static route session parameters

BFD sessions are configured with default intervals and a default role. The parameters that can be configured are: Desired TX Interval, Required Min RX Interval, Detection Multiplier, and system role. These parameters are configured for all static routes; if you change a parameter, the change affects all sessions for static routes.

To change parameters for static route sessions:

| Step | Task | Command Syntax | Command Mode |
|------|--|---|---------------|
| 1 | Change parameters for all static route sessions. | <code>ip route bfd interval <i>milliseconds</i> min_rx <i>milliseconds</i> multiplier <i>value</i> role [active passive]</code> | CONFIGURATION |

View session parameters using the command `show bfd neighbors detail`, as shown in the example in [Verifying BFD sessions with BGP neighbors using show bfd neighbors detail](#).

Disabling BFD for static routes

If BFD is disabled, all static route BFD sessions are torn down. A final Admin Down packet is sent to all neighbors on the remote systems, and those neighbors change to the Down state ([Message 3](#)).

To disable BFD for static routes:

| Step | Task | Command Syntax | Command Mode |
|------|--------------------------------|------------------------------|---------------|
| 1 | Disable BFD for static routes. | <code>no ip route bfd</code> | CONFIGURATION |

Configuring BFD for OSPF

BFD for OSPF is only supported on platforms:    

When using BFD with OSPF, the OSPF protocol registers with the BFD manager on the RPM. BFD sessions are established with all neighboring interfaces participating in OSPF. If a neighboring interface fails, the BFD agent on the line card notifies the BFD manager, which in turn notifies the OSPF protocol that a link state change occurred.

Configuring BFD for OSPF is a two-step process:

1. Enabling BFD globally.
2. Establishing sessions with OSPF neighbors.

Related configuration tasks

- Changing OSPF session parameters.
- Disabling BFD for OSPF.

Establishing sessions with OSPF neighbors

BFD sessions can be established with all OSPF neighbors at once or sessions can be established with all neighbors out of a specific interface. Sessions are only established when the OSPF adjacency is in the full state.

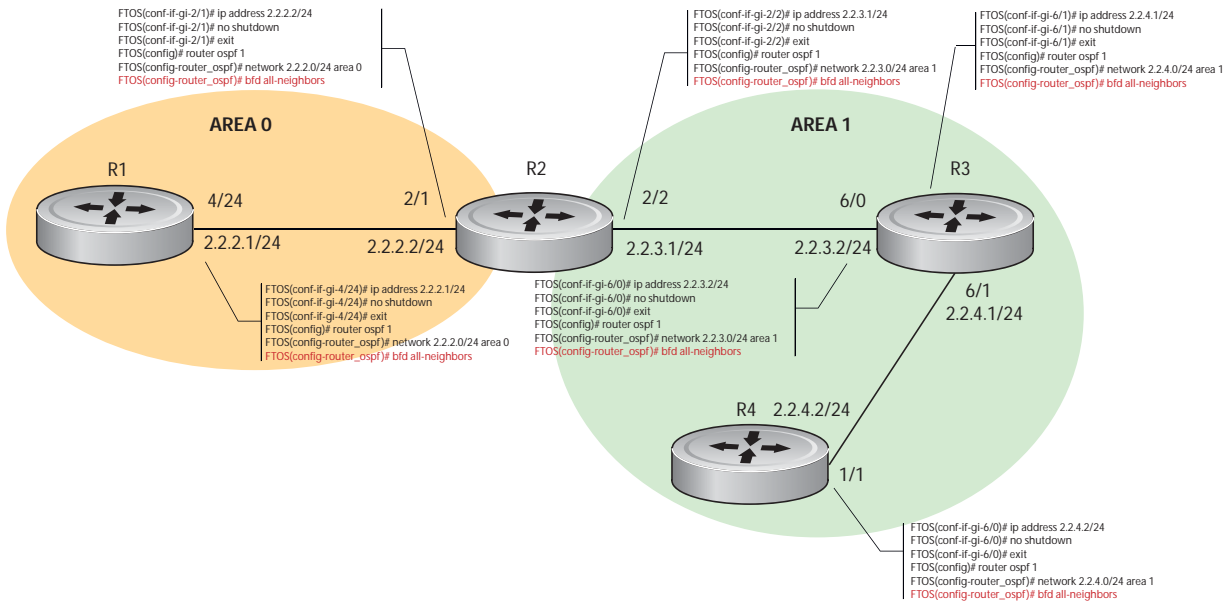

To establish BFD with all OSPF neighbors:

| Step | Task | Command Syntax | Command Mode |
|------|---|-------------------|--------------|
| 1 | Establish sessions with all OSPF neighbors. | bfd all-neighbors | ROUTER-OSPF |

To establish BFD for all OSPF neighbors on a single interface:

| Step | Task | Command Syntax | Command Mode |
|------|---|---------------------------|--------------|
| 1 | Establish sessions with all OSPF neighbors on a single interface. | ip ospf bfd all-neighbors | INTERFACE |

View the established sessions using the command `show bfd neighbors`, as shown in the example below.

```
R2(conf-router_ospf)#bfd all-neighbors
R2(conf-router_ospf)#do show bfd neighbors
```

```
*          - Active session role
Ad Dn     - Admin Down
C         - CLI
I         - ISIS
O         - OSPF
R         - Static Route (RTM)
```

```
LocalAddr RemoteAddr Interface State Rx-int Tx-int Mult Clients
* 2.2.2.2   2.2.2.1   Gi 2/1   Up    100   100   3    o
* 2.2.3.1   2.2.3.2   Gi 2/2   Up    100   100   3    o
```

Changing OSPF session parameters

BFD sessions are configured with default intervals and a default role. The parameters that can be configured are: Desired TX Interval, Required Min RX Interval, Detection Multiplier, and system role. These parameters are configured for all OSPF sessions or all OSPF sessions on a particular interface; if you change a parameter globally, the change affects all OSPF neighbors sessions. If you change a parameter at interface level, the change affects all OSPF sessions on that interface.

To change parameters for all OSPF sessions:

| Step | Task | Command Syntax | Command Mode |
|------|--------------------------------------|--|--------------|
| 1 | Change parameters for OSPF sessions. | <code>bfd all-neighbors interval <i>milliseconds</i> min_rx <i>milliseconds</i> multiplier <i>value</i> role [active passive]</code> | ROUTER-OSPF |

To change parameters for OSPF sessions on an interface:

| Step | Task | Command Syntax | Command Mode |
|------|--|--|--------------|
| 1 | Change parameters for all OSPF sessions on an interface. | <code>ip ospf bfd all-neighbors interval <i>milliseconds</i> min_rx <i>milliseconds</i> multiplier <i>value</i> role [active passive]</code> | INTERFACE |

View session parameters using the command `show bfd neighbors detail`, as shown in the example in [Displaying BFD for BGP Information](#).

Disabling BFD for OSPF

If BFD is disabled globally, all sessions are torn down, and sessions on the remote system are placed in a Down state. If BFD is disabled on an interface, sessions on the interface are torn down, and sessions on the remote system are placed in a Down state ([Message 3](#)). Disabling BFD does not trigger a change in BFD clients; a final Admin Down packet is sent before the session is terminated.

To disable BFD sessions with all OSPF neighbors:

| Step | Task | Command Syntax | Command Mode |
|------|---|----------------------|--------------|
| 1 | Disable BFD sessions with all OSPF neighbors. | no bfd all-neighbors | ROUTER-OSPF |

To disable BFD sessions with all OSPF neighbors out of an interface:

| Step | Task | Command Syntax | Command Mode |
|------|--|--------------------------------------|--------------|
| 1 | Disable BFD sessions with all OSPF neighbors out of an interface | ip ospf bfd all-neighbors disable | INTERFACE |

Configuring BFD for IS-IS

BFD for IS-IS is supported on platforms:  **S4810** **S4820T**

When using BFD with IS-IS, the IS-IS protocol registers with the BFD manager on the RPM. BFD sessions are then established with all neighboring interfaces participating in IS-IS. If a neighboring interface fails, the BFD agent on the line card notifies the BFD manager, which in turn notifies the IS-IS protocol that a link state change occurred.

Configuring BFD for IS-IS is a two-step process:

1. Enable BFD globally. See [Enabling BFD globally on page 152](#).
2. Establish sessions for all or particular IS-IS neighbors.

Related configuration tasks

- Change session parameters.
- Disable BFD sessions for IS-IS.

Establishing sessions with IS-IS neighbors

BFD sessions can be established for all IS-IS neighbors at once or sessions can be established for all neighbors out of a specific interface.

Figure 8-2. Establishing Sessions with IS-IS Neighbors

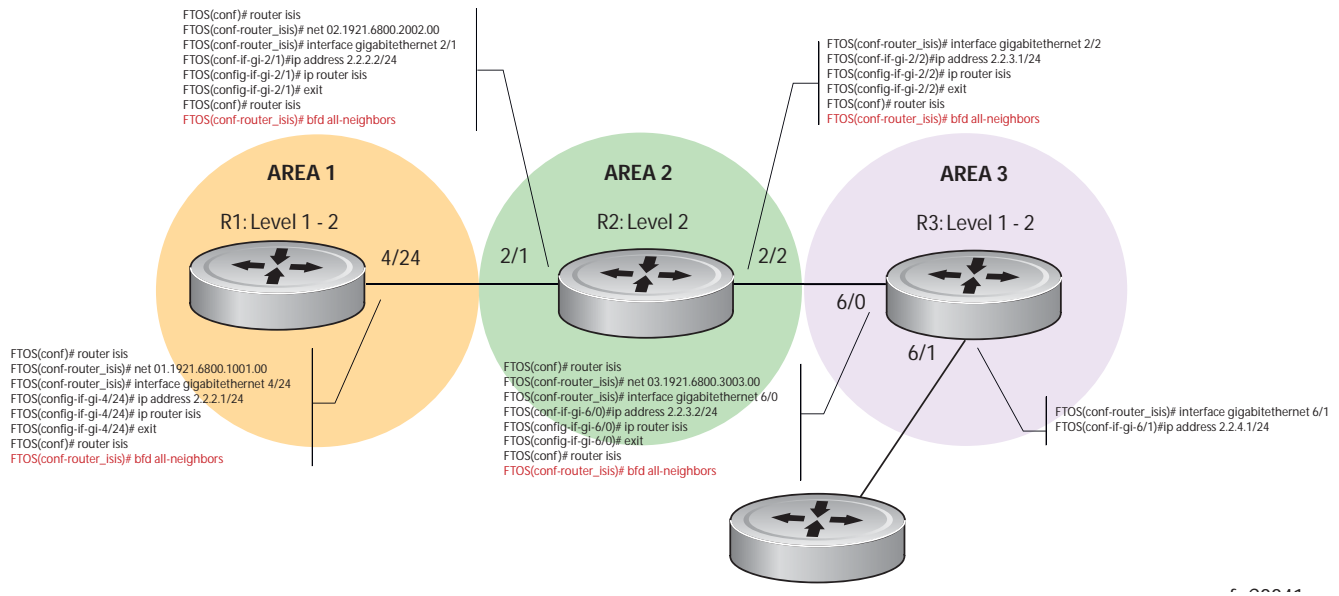

To establish BFD with all IS-IS neighbors:

| Step | Task | Command Syntax | Command Mode |
|------|--|-------------------|--------------|
| 1 | Establish sessions with all IS-IS neighbors. | bfd all-neighbors | ROUTER-ISIS |

To establish BFD with all IS-IS neighbors out of a single interface:

| Step | Task | Command Syntax | Command Mode |
|------|--|------------------------|--------------|
| 1 | Establish sessions with all IS-IS neighbors out of an interface. | isis bfd all-neighbors | INTERFACE |

View the established sessions using the command `show bfd neighbors`, as shown in Figure 8-3.

Figure 8-3. Viewing Established Sessions for IS-IS Neighbors

```

R2(conf-router_isis)#bfd all-neighbors
R2(conf-router_isis)#do show bfd neighbors

*      - Active session role
Ad Dn  - Admin Down
C      - CLI
I      - ISIS
O      - OSPF
R      - Static Route (RTM)

LocalAddr      RemoteAddr      Interface State Rx-int Tx-int Mult
Clients
* 2.2.2.2      2.2.2.1      Gi 2/1    Up    100   100   3    I
  
```

IS-IS BFD Sessions Enabled

Changing IS-IS session parameters

BFD sessions are configured with default intervals and a default role. The parameters that can be configured are: Desired TX Interval, Required Min RX Interval, Detection Multiplier, and system role. These parameters are configured for all IS-IS sessions or all IS-IS sessions out of an interface; if you change a parameter globally, the change affects all IS-IS neighbors sessions. If you change a parameter at interface level, the change affects all IS-IS sessions on that interface.

To change parameters for all IS-IS sessions:

| Step | Task | Command Syntax | Command Mode |
|------|---|--|--------------|
| 1 | Change parameters for all IS-IS sessions. | <code>bfd all-neighbors interval <i>milliseconds</i> min_rx <i>milliseconds</i> multiplier <i>value</i> role [active passive]</code> | ROUTER-ISIS |

To change parameters for IS-IS sessions on an interface:

| Step | Task | Command Syntax | Command Mode |
|------|---|---|--------------|
| 1 | Change parameters for all IS-IS sessions out of an interface. | <code>isis bfd all-neighbors interval <i>milliseconds</i> min_rx <i>milliseconds</i> multiplier <i>value</i> role [active passive]</code> | INTERFACE |

View session parameters using the command `show bfd neighbors detail`.

Disabling BFD for IS-IS

If BFD is disabled globally, all sessions are torn down, and sessions on the remote system are placed in a Down state. If BFD is disabled on an interface, sessions on the interface are torn down, and sessions on the remote system are placed in a Down state ([Message 3](#)). Disabling BFD does not trigger a change in BFD clients; a final Admin Down packet is sent before the session is terminated.

To disable BFD sessions with all IS-IS neighbors:

| Step | Task | Command Syntax | Command Mode |
|------|--|-----------------------------------|--------------|
| 1 | Disable BFD sessions with all IS-IS neighbors. | <code>no bfd all-neighbors</code> | ROUTER-ISIS |

To disable BFD sessions with all IS-IS neighbors out of an interface:

| Step | Task | Command Syntax | Command Mode |
|------|--|---|--------------|
| 1 | Disable BFD sessions with all IS-IS neighbors out of an interface. | <code>isis bfd all-neighbors disable</code> | INTERFACE |

Configuring BFD for BGP

BFD for BGP is only supported on platforms:    

In a BGP core network, BFD provides rapid detection of communication failures in BGP fast-forwarding paths between internal BGP (iBGP) and external BGP (eBGP) peers for faster network reconvergence. BFD for BGP is supported on 1GE, 10GE, 40GE, port-channel, and VLAN interfaces. BFD for BGP does not support IPv6 and the BGP multihop feature.

Prerequisites

Before configuring BFD for BGP, you must first configure the following settings:

1. Configure BGP on the routers that you want to interconnect as described in [Chapter 9, Border Gateway Protocol IPv4 \(BGPv4\)](#).
2. Enable fast fall-over for BGP neighbors to reduce convergence time (**neighbor fall-over** command) as described in [BGP fast fall-over](#).

Establishing sessions with BGP neighbors

Before configuring BFD for BGP, you must first configure BGP on the routers that you want to interconnect. For more information, refer to [Chapter 9, Border Gateway Protocol IPv4 \(BGPv4\)](#).

For example, the following illustration shows a sample BFD configuration on Router 1 and Router 2 that use eBGP in a transit network to interconnect AS1 and AS2. The eBGP routers exchange information with each other as well as with iBGP routers to maintain connectivity and accessibility within each autonomous system.

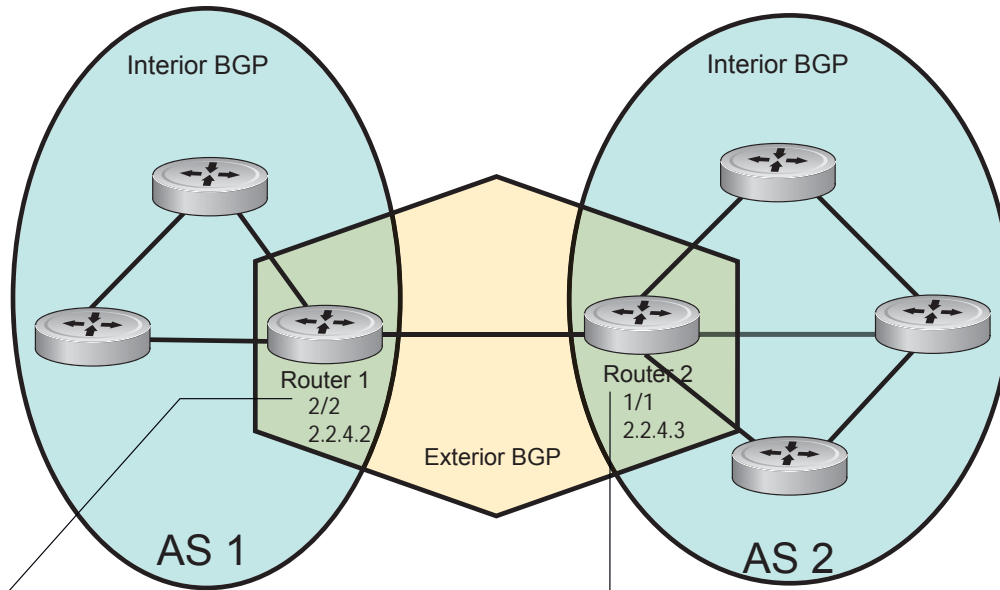

```

FTOS(conf)# bfd enable
FTOS(conf)# router bgp 1
FTOS(conf-router-bgp)# neighbor 2.2.4.3 remote-as 2
FTOS(conf-router-bgp)# neighbor 2.2.4.3 no shutdown
FTOS(conf-router-bgp)# bfd all-neighbors interval 200 min_rx 200
multiplier 6 role active
OR
FTOS(conf-router-bgp)# neighbor 2.2.4.3 bfd

```

```

FTOS(conf)# bfd enable
FTOS(conf)# router bgp 2
FTOS(conf-router-bgp)# neighbor 2.2.4.2 remote-as 1
FTOS(conf-router-bgp)# neighbor 2.2.4.2 no shutdown
FTOS(conf-router-bgp)# bfd all-neighbors interval 200 min_rx 200
multiplier 6 role active
OR
FTOS(conf-router-bgp)# neighbor 2.2.4.2 bfd

```

Note that the sample configuration shows alternative ways to establish a BFD session with a BGP neighbor:

- By establishing BFD sessions with all neighbors discovered by BGP (bfd all-neighbors command)
- By establishing a BFD session with a specified BGP neighbor (neighbor {ip-address | peer-group-name} bfd command)

BFD packets originating from a router are assigned to the highest priority egress queue to minimize transmission delays. Incoming BFD control packets received from the BGP neighbor are assigned to the highest priority queue within the Control Plane Policing (COPP) framework to avoid BFD packets drops due to queue congestion.

BFD notifies BGP of any failure conditions that it detects on the link. Recovery actions are initiated by BGP.

BFD for BGP is supported only on directly-connected BGP neighbors and only in BGP IPv4 networks.

- On an E-Series ExaScale, up to 100 simultaneous BFD sessions are supported.
- On an S4810 or an S4820T, up to 128 simultaneous BFD sessions are supported.

As long as each BFD for BGP neighbor receives a BFD control packet within the configured BFD interval for failure detection, the BFD session remains up and BGP maintains its adjacencies. If a BFD for BGP neighbor does not receive a control packet within the detection interval, the router informs any clients of the BFD session (other routing protocols) about the failure. It then depends on the individual routing protocols that uses the BGP link to determine the appropriate response to the failure condition. The typical response is usually to terminate the peering session for the routing protocol and reconverge by bypassing the failed neighboring router. A log message is generated whenever BFD detects a failure condition.

On C-Series and E-Series only, you can configure BFD for BGP on the following types of interfaces: physical port (10GE or 40GE), port channel, and VLAN.

To establish a BFD session with one or all BGP neighbors, follow these steps:

| Step | Task | Command Syntax | Command Mode |
|--|---|--|-------------------|
| 1 | Enable BFD globally. | <code>bfd enable</code> | CONFIGURATION |
| 2 | Specify the AS number and enter ROUTER BGP configuration mode. | <code>router bgp <i>as-number</i></code> | CONFIGURATION |
| 3 | Add a BGP neighbor or peer group in a remote AS. | <code>neighbor {<i>ip-address</i> <i>peer-group name</i>} remote-as <i>as-number</i></code> | CONFIG-ROUTER-BGP |
| 4 | Enable the BGP neighbor. | <code>neighbor {<i>ip-address</i> <i>peer-group-name</i>} no shutdown</code> | CONFIG-ROUTER-BGP |
| 5 | Configure parameters for a BFD session established with all neighbors discovered by BGP. | <code>bfd all-neighbors [interval <i>milliseconds</i> min_rx <i>milliseconds</i> multiplier <i>value</i> role {<i>active</i> <i>passive</i>}]</code> | CONFIG-ROUTER-BGP |
| | OR | OR | |
| | Establish a BFD session with a specified BGP neighbor or peer group using the default BFD session parameters. | <code>neighbor {<i>ip-address</i> <i>peer-group-name</i>} bfd</code> | |
| Notes: | | | |
| - When you establish a BFD session with a specified BGP neighbor or peer group using the neighbor bfd command, the default BFD session parameters are used (interval: 100 milliseconds, min_rx: 100 milliseconds, multiplier: 3 packets, and role: active). | | | |
| - When you explicitly enable or disable a BGP neighbor for a BFD session with the neighbor bfd or neighbor bfd disable commands: | | | |
| - The neighbor does not inherit the BFD enable/disable values configured with the bfd all-neighbors command or configured for the peer group to which the neighbor belongs. | | | |
| - The neighbor only inherits the global timer values configured with the bfd all-neighbors command (interval , min_rx , and multiplier). | | | |
| 6 | Repeat Steps 1 to 5 on each BGP peer participating in a BFD session. | | |

Disabling BFD for BGP

To disable a BFD for BGP session with a specified neighbor, enter the `neighbor {ip-address | peer-group-name} bfd disable` command in ROUTER BGP configuration mode.

To remove the disabled state of a BFD for BGP session with a specified neighbor, enter the `no neighbor {ip-address | peer-group-name} bfd disable` command in ROUTER BGP configuration mode. The BGP link with the neighbor returns to normal operation and uses the BFD session parameters globally configured with the `bfd all-neighbors` command or configured for the peer group to which the neighbor belongs.

Using BFD in a BGP Peer Group

If you establish a BFD session for the members of a peer group (`neighbor peer-group-name bfd` command in ROUTER BGP configuration mode), members of the peer group may have BFD:

- Explicitly enabled (`neighbor ip-address bfd` command)
- Explicitly disabled (`neighbor ip-address bfd disable` command)
- Inherited (neither explicitly enabled or disabled) according to the current BFD configuration of the peer group. For information on BGP peer groups, refer to [Configure Peer Groups](#).

If you explicitly enable (or disable) a BGP neighbor for BFD that belongs to a peer group:

- The neighbor does not inherit the BFD enable/disable values configured with the `bfd all-neighbors` command or configured for the peer group to which the neighbor belongs.
- The neighbor inherits only the global timer values that are configured with the `bfd all-neighbors` command (interval, min_rx, and multiplier).

If you explicitly enable (or disable) a peer group for BFD that has no BFD parameters configured (e.g. advertisement interval) using the `neighbor peer-group-name bfd` command, the peer group inherits any BFD settings configured with the `bfd all-neighbors` command.

Displaying BFD for BGP Information

To display information about BFD for BGP sessions on a router, enter one of the following show commands:

| Task | Command | Command Mode |
|--|--|----------------|
| Verify a BFD for BGP configuration. | <code>show running-config bgp</code> Verifying a BFD for BGP Configuration | EXEC Privilege |
| Verify that a BFD for BGP session has been successfully established with a BGP neighbor. A line-by-line listing of established BFD adjacencies is displayed. | <code>show bfd neighbors [interface] [detail]</code> Verifying BFD sessions with BGP neighbors using show bfd neighbors and Verifying BFD sessions with BGP neighbors using show bfd neighbors detail | EXEC Privilege |
| Check to see if BFD is enabled for BGP connections. | <code>show ip bgp summary</code> Displaying BFD for BGP status | EXEC Privilege |
| Displays routing information exchanged with BGP neighbors, including BFD for BGP sessions. | <code>show ip bgp neighbors [ip-address]</code> Displaying Routing Sessions with BGP neighbors | EXEC Privilege |

The following examples show the BFD for BGP output displayed for these show commands.

Verifying a BFD for BGP Configuration

```
R2# show running-config bgp
!
router bgp 2
 neighbor 1.1.1.2 remote-as 1
 neighbor 1.1.1.2 no shutdown
 neighbor 2.2.2.2 remote-as 1
 neighbor 2.2.2.2 no shutdown
 neighbor 3.3.3.2 remote-as 1
 neighbor 3.3.3.2 no shutdown
 bfd all-neighbors
```

Verifying BFD sessions with BGP neighbors using show bfd neighbors

```
R2# show bfd neighbors
```

```
*          - Active session role
Ad Dn     - Admin Down
B         - BGP
C         - CLI
I         - ISIS
O         - OSPF
R         - Static Route (RTM)
M         - MPLS
V         - VRRP
```

| LocalAddr | RemoteAddr | Interface | State | Rx-int | Tx-int | Mult | Clients |
|-----------|------------|-----------|-------|--------|--------|------|---------|
| * 1.1.1.3 | 1.1.1.2 | Te 6/0 | Up | 100 | 100 | 3 | B |
| * 2.2.2.3 | 2.2.2.2 | Te 6/1 | Up | 100 | 100 | 3 | B |
| * 3.3.3.3 | 3.3.3.2 | Te 6/2 | Up | 100 | 100 | 3 | B |

Verifying BFD sessions with BGP neighbors using show bfd neighbors detail

```
R2# show bfd neighbors detail
```

```
Session Discriminator: 9
Neighbor Discriminator: 10
Local Addr: 1.1.1.3
Local MAC Addr: 00:01:e8:66:da:33
Remote Addr: 1.1.1.2
Remote MAC Addr: 00:01:e8:8a:da:7b
Int: TenGigabitEthernet 6/0
State: Up
Configured parameters:
TX: 100ms, RX: 100ms, Multiplier: 3
Neighbor parameters:
TX: 100ms, RX: 100ms, Multiplier: 3
Actual parameters:
TX: 100ms, RX: 100ms, Multiplier: 3
Role: Active
```

```

Delete session on Down: True
Client Registered: BGP
Uptime: 00:07:55
Statistics:
Number of packets received from neighbor: 4762
Number of packets sent to neighbor: 4490
Number of state changes: 2
Number of messages from IFA about port state change: 0
Number of messages communicated b/w Manager and Agent: 5

```

```

Session Discriminator: 10
Neighbor Discriminator: 11
Local Addr: 2.2.2.3
Local MAC Addr: 00:01:e8:66:da:34
Remote Addr: 2.2.2.2
Remote MAC Addr: 00:01:e8:8a:da:7b
Int: TenGigabitEthernet 6/1
State: Up
Configured parameters:
TX: 100ms, RX: 100ms, Multiplier: 3
Neighbor parameters:
TX: 100ms, RX: 100ms, Multiplier: 3
Actual parameters:
TX: 100ms, RX: 100ms, Multiplier: 3
Role: Active
Delete session on Down: True
Client Registered: BGP
Uptime: 00:02:22
Statistics:
Number of packets received from neighbor: 1428
Number of packets sent to neighbor: 1428
Number of state changes: 1
Number of messages from IFA about port state change: 0
Number of messages communicated b/w Manager and Agent: 4

```

Displaying BFD Packet Counters

```
R2# show bfd counters bgp
```

```

Interface TenGigabitEthernet 6/0
Protocol BGP
Messages:
Registration      : 5
De-registration  : 4
Init              : 0
Up                : 6
Down              : 0
Admin Down        : 2

```

```
Interface TenGigabitEthernet 6/1
```

```

Protocol BGP
Messages:
Registration      : 5
De-registration  : 4
Init             : 0
Up              : 6
Down            : 0
Admin Down      : 2

```

Interface TenGigabitEthernet 6/2

```

Protocol BGP
Messages:
Registration      : 1
De-registration  : 0
Init             : 0
Up              : 1
Down            : 0
Admin Down      : 2

```

Displaying BFD for BGP status

```

R2# show ip bgp summary
BGP router identifier 10.0.0.1, local AS number 2
BGP table version is 0, main routing table version 0
BFD is enabled, Interval 100 Min_rx 100 Multiplier 3 Role Active
3 neighbor(s) using 24168 bytes of memory

```

| Neighbor | AS | MsgRcvd | MsgSent | TblVer | InQ | OutQ | Up/Down | State/Pfx |
|----------|----|---------|---------|--------|-----|------|----------|-----------|
| 1.1.1.2 | 1 | 282 | 281 | 0 | 0 | 0 | 00:38:12 | 0 |
| 2.2.2.2 | 1 | 273 | 273 | 0 | 0 | (0) | 04:32:26 | 0 |
| 3.3.3.2 | 1 | 282 | 281 | 0 | 0 | 0 | 00:38:12 | 0 |

Displaying Routing Sessions with BGP neighbors

```

R2# show ip bgp neighbors 2.2.2.2

BGP neighbor is 2.2.2.2, remote AS 1, external link
  BGP version 4, remote router ID 12.0.0.4
  BGP state ESTABLISHED, in this state for 00:05:33
  Last read 00:00:30, last write 00:00:30
  Hold time is 180, keepalive interval is 60 seconds
  Received 8 messages, 0 in queue
    1 opens, 0 notifications, 0 updates
    7 keepalives, 0 route refresh requests
  Sent 9 messages, 0 in queue
    2 opens, 0 notifications, 0 updates
    7 keepalives, 0 route refresh requests
  Minimum time between advertisement runs is 30 seconds
  Minimum time before advertisements start is 0 seconds

```

```
Capabilities received from neighbor for IPv4 Unicast :
  MULTIPROTO_EXT(1)
  ROUTE_REFRESH(2)
  CISCO_ROUTE_REFRESH(128)
```

```
Capabilities advertised to neighbor for IPv4 Unicast :
  MULTIPROTO_EXT(1)
  ROUTE_REFRESH(2)
  CISCO_ROUTE_REFRESH(128)
```

Neighbor is using BGP global mode BFD configuration

```
For address family: IPv4 Unicast
BGP table version 0, neighbor version 0
Prefixes accepted 0 (consume 0 bytes), withdrawn 0 by peer, martian prefixes ignored 0
Prefixes advertised 0, denied 0, withdrawn 0 from peer
```

```
Connections established 1; dropped 0
Last reset never
Local host: 2.2.2.3, Local port: 63805
Foreign host: 2.2.2.2, Foreign port: 179
E1200i_ExaScale#
```

R2# show ip bgp neighbors 2.2.2.3

```
BGP neighbor is 2.2.2.3, remote AS 1, external link
  Member of peer-group pgl for session parameters
  BGP version 4, remote router ID 12.0.0.4
  BGP state ESTABLISHED, in this state for 00:05:33
  ...
  Neighbor is using BGP neighbor mode BFD configuration
  Peer active in peer-group outbound optimization
  ...
```

R2# show ip bgp neighbors 2.2.2.4

```
BGP neighbor is 2.2.2.4, remote AS 1, external link
  Member of peer-group pgl for session parameters
  BGP version 4, remote router ID 12.0.0.4
  BGP state ESTABLISHED, in this state for 00:05:33
  ...
  Neighbor is using BGP peer-group mode BFD configuration
  Peer active in peer-group outbound optimization
  ...
```

Configuring BFD for VRRP

BFD for VRRP is only supported on platforms:  

When using BFD with VRRP, the VRRP protocol registers with the BFD manager on the RPM. BFD sessions are established with all neighboring interfaces participating in VRRP. If a neighboring interface fails, the BFD agent on the line card notifies the BFD manager, which in turn notifies the VRRP protocol that a link state change occurred.

Configuring BFD for VRRP is a three-step process:

1. Enable BFD globally. Refer to [Enabling BFD globally](#).
2. Establish VRRP BFD sessions with all VRRP-participating neighbors.
3. On the master router, establish a VRRP BFD sessions with the backup routers. Refer to [Establishing sessions with all VRRP neighbors](#).

Related configuration tasks

- [Changing VRRP session parameters](#).
- [Establishing sessions with OSPF neighbors](#).

Establishing sessions with all VRRP neighbors

BFD sessions can be established for all VRRP neighbors at once, or a session can be established with a particular neighbor.

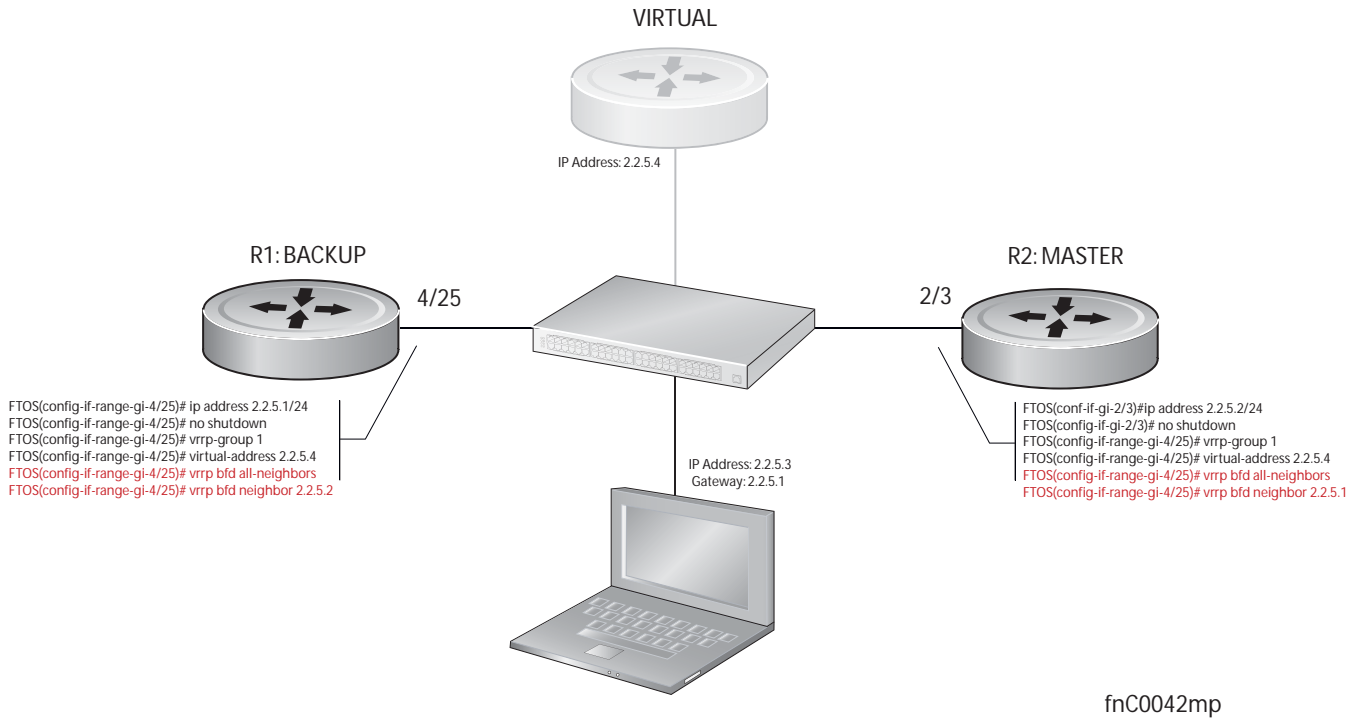

To establish sessions with all VRRP neighbors:

| Step | Task | Command Syntax | Command Mode |
|------|---|------------------------|--------------|
| 1 | Establish sessions with all VRRP neighbors. | vrrp bfd all-neighbors | INTERFACE |

Establishing VRRP sessions on VRRP neighbors

The master router does not care about the state of the backup router, so it does not participate in any VRRP BFD sessions. Therefore, VRRP BFD sessions on the backup router cannot change to the UP state. The master router must be configured to establish an individual VRRP session the backup router.

To establish a session with a particular VRRP neighbor:

| Step | Task | Command Syntax | Command Mode |
|------|--|-------------------------------------|--------------|
| 1 | Establish a session with a particular VRRP neighbor. | vrrp bfd neighbor <i>ip-address</i> | INTERFACE |

View the established sessions using the command `show bfd neighbors`, as shown in the example below.

```

R1(conf-if-gi-4/25)#vrrp bfd all-neighbors
R1(conf-if-gi-4/25)#do show bfd neighbor
    
```

```

*          - Active session role
Ad Dn     - Admin Down
    
```



```

C      - CLI
I      - ISIS
O      - OSPF
R      - Static Route (RTM)
V      - VRRP

```

```

      LocalAddr      RemoteAddr      Interface State Rx-int Tx-int Mult Clients
* 2.2.5.1      2.2.5.2      Gi 4/25      Down 1000 1000 3 V

```

Session state information is also shown in the show vrrp command output, as shown in the following example.

```

R1(conf-if-gi-4/25)#do show vrrp
-----
GigabitEthernet 4/1, VRID: 1, Net: 2.2.5.1
State: Backup, Priority: 1, Master: 2.2.5.2
Hold Down: 0 sec, Preempt: TRUE, AdvInt: 1 sec
Adv rcvd: 95, Bad pkts rcvd: 0, Adv sent: 933, Gratuitous ARP sent: 3
Virtual MAC address:
  00:00:5e:00:01:01
Virtual IP address:
  2.2.5.4
Authentication: (none)
BFD Neighbors:
RemoteAddr      State
2.2.5.2         Up

```

Changing VRRP session parameters

BFD sessions are configured with default intervals and a default role. The parameters that can be configured are: Desired TX Interval, Required Min RX Interval, Detection Multiplier, and system role. You can change parameters for all VRRP sessions for a particular neighbor.

To change parameters for all VRRP sessions:

| Step | Task | Command Syntax | Command Mode |
|------|--|--|--------------|
| 1 | Change parameters for all VRRP sessions. | vrrp bfd all-neighbors interval <i>milliseconds</i> min_rx <i>milliseconds</i> multiplier <i>value</i> role [active passive] | INTERFACE |

To change parameters for a particular VRRP session:

| Step | Task | Command Syntax | Command Mode |
|------|--|---|--------------|
| 1 | Change parameters for a particular VRRP session. | vrrp bfd neighbor <i>ip-address</i> interval <i>milliseconds</i> min_rx <i>milliseconds</i> multiplier <i>value</i> role [active passive] | INTERFACE |

View session parameters using the command `show bfd neighbors detail`, as shown in the example in [Verifying BFD sessions with BGP neighbors using show bfd neighbors detail](#).

Disabling BFD for VRRP

If any or all VRRP sessions are disabled, the sessions are torn down. A final Admin Down control packet is sent to all neighbors and sessions on the remote system change to the Down state ([Message 3](#)).

To disable all VRRP sessions on an interface:

| Step | Task | Command Syntax | Command Mode |
|------|--|--|--------------|
| 1 | Disable all VRRP sessions on an interface. | <code>no vrrp bfd all-neighbors</code> | INTERFACE |

To disable all VRRP sessions in a particular VRRP group:

| Step | Task | Command Syntax | Command Mode |
|------|--|--------------------------|--------------|
| 1 | Disable all VRRP sessions in a VRRP group. | <code>bfd disable</code> | VRRP |

To disable a particular VRRP session:

| Step | Task | Command Syntax | Command Mode |
|------|--|--|--------------|
| 1 | Disable a particular VRRP session on an interface. | <code>no vrrp bfd neighbor ip-address</code> | INTERFACE |

Configuring BFD for VLANs

Configuring BFD for VLANs is supported on C-Series and E-Series only.

BFD on Dell Force10 systems is a Layer 3 protocol. Therefore, BFD is used with routed VLANs. BFD on VLANs is analogous to BFD on physical ports. If no routing protocol is enabled, and a remote system fails, the local system does not remove the connected route until the first failed attempt to send a packet. If BFD is enabled, the local system removes the route when it stops receiving periodic control packets from the remote system.

There is one BFD Agent for VLANs and port-channels, which resides on RP2 as opposed to the other agents which are on the line card. Therefore, the 100 total possible sessions that this agent can maintain is shared for VLANs and port-channels.

Configuring BFD for VLANs is a two-step process:

1. [Enabling BFD globally](#).
2. [Establishing sessions with VLAN neighbors](#).

Related configuration tasks

- [Establishing sessions with OSPF neighbors.](#)

Establishing sessions with VLAN neighbors

To establish a session, BFD must be enabled at interface level on both ends of the link, as shown in the illustration below. The session parameters do not need to match.

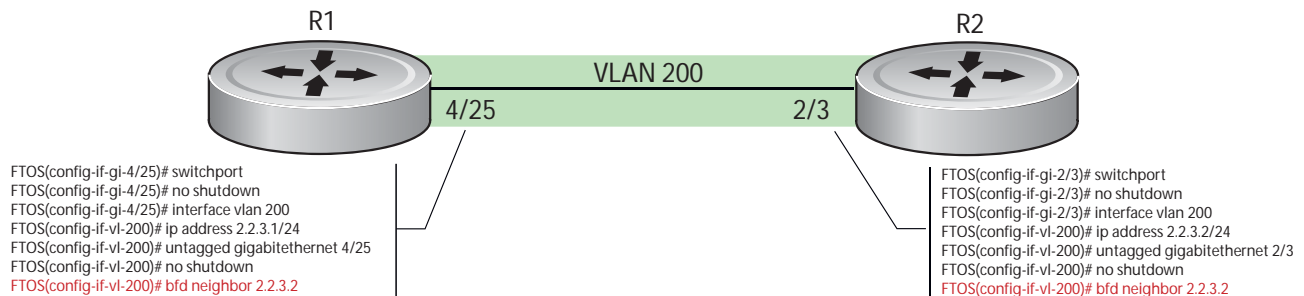

fnC0043mp

Disabling BFD for VLANs

If BFD is disabled on an interface, sessions on the interface are torn down. A final Admin Down control packet is sent to all neighbors, and sessions on the remote system change to the Down state ([Message 3](#)).

To disable BFD on a VLAN interface:

| Step | Task | Command Syntax | Command Mode |
|------|---|----------------|----------------|
| 1 | Disable all sessions on a VLAN interface. | no bfd enable | INTERFACE VLAN |

Configuring BFD for Port-Channels

Configuring BFD for port-channels is supported on C-Series and E-Series only.

BFD on port-channels is analogous to BFD on physical ports. If no routing protocol is enabled, and a remote system fails, the local system does not remove the connected route until the first failed attempt to send a packet. If BFD is enabled, the local system removes the route when it stops receiving periodic control packets from the remote system.

There is one BFD Agent for VLANs and port-channels, which resides on RP2 as opposed to the other agents which are on the line card. Therefore, the 100 total possible sessions that this agent can maintain is shared for VLANs and port-channels.

Configuring BFD for port-channels is a two-step process:

1. Enabling BFD globally.
2. Establishing sessions on port-channels.

Related configuration tasks

- Disabling BFD for port-channels.

Establishing sessions on port-channels

To establish a session, BFD must be enabled at interface level on both ends of the link, as shown in the example below. The session parameters do not need to match.

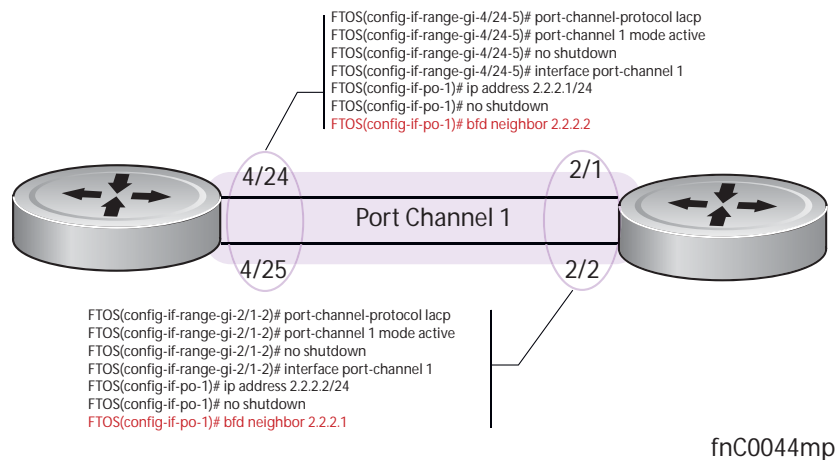

Disabling BFD for port-channels

If BFD is disabled on an interface, sessions on the interface are torn down. A final Admin Down control packet is sent to all neighbors, and sessions on the remote system are placed in a Down state ([Message 3](#)).

To disable BFD for a port-channel:

| Step | Task | Command Syntax | Command Mode |
|------|---------------------------------|----------------|------------------------|
| 1 | Disable BFD for a port-channel. | no bfd enable | INTERFACE PORT-CHANNEL |

Configuring Protocol Liveness

Protocol Liveness is a feature that notifies the BFD Manager when a client protocol is disabled. When a client is disabled, all BFD sessions for that protocol are torn down. Neighbors on the remote system receive an Admin Down control packet and are placed in the Down state ([Message 3](#)).

To enable Protocol Liveness:

| Step | Task | Command Syntax | Command Mode |
|------|--------------------------|-----------------------|---------------|
| 1 | Enable Protocol Liveness | bfd protocol-liveness | CONFIGURATION |

Troubleshooting BFD

Examine control packet field values using the command `debug bfd detail`. The following example shows a three-way handshake using this command.

```
R1(conf-if-gi-4/24)#00:54:38: %RPM0-P:RP2 %BFDMGR-1-BFD_STATE_CHANGE: Changed session state to
Down for neighbor 2.2.2.2 on interface Gi 4/24 (diag: 0)
00:54:38 : Sent packet for session with neighbor 2.2.2.2 on Gi 4/24
TX packet dump:
  Version:1, Diag code:0, State:Down, Poll bit:0, Final bit:0, Demand bit:0
  myDiscrim:4, yourDiscrim:0, minTx:1000000, minRx:1000000, multiplier:3, minEchoRx:0
00:54:38 : Received packet for session with neighbor 2.2.2.2 on Gi 4/24
RX packet dump:
  Version:1, Diag code:0, State:Init, Poll bit:0, Final bit:0, Demand bit:0
  myDiscrim:6, yourDiscrim:4, minTx:1000000, minRx:1000000, multiplier:3, minEchoRx:0
00:54:38: %RPM0-P:RP2 %BFDMGR-1-BFD_STATE_CHANGE: Changed session state to Up for neighbor 2.2.2.2
on interface Gi 4/24 (diag: 0)
```

Examine control packets in hexadecimal format using the command `debug bfd packet`.

```
RX packet dump:
  20 c0 03 18 00 00 00 05 00 00 00 04 00 01 86 a0
  00 01 86 a0 00 00 00 00
00:34:13 : Sent packet for session with neighbor 2.2.2.2 on Gi 4/24
TX packet dump:
  20 c0 03 18 00 00 00 04 00 00 00 05 00 01 86 a0
  00 01 86 a0 00 00 00 00
00:34:14 : Received packet for session with neighbor 2.2.2.2 on Gi 4/24
RX packet dump:
  20 c0 03 18 00 00 00 05 00 00 00 04 00 01 86 a0
  00 01 86 a0 00 00 00 00
00:34:14 : Sent packet for session with neighbor 2.2.2.2 on Gi 4/24
TX packet dump:
  20 c0 03 18 00 00 00 04 00 00 00 05 00 01 86 a0
  00 01 86 a0 00 00 00 00
00:34:14 : Received packet for session with neighbor 2.2.2.2 on Gi 4/24
RX packet dump:
```

```
20 c0 03 18 00 00 00 05 00 00 00 04 00 01 86 a0
00 01 86 a0 00 00 00 00
00:34:14 : Sent packet for session with neighbor 2.2.2.2 on Gi 4/24
L
```

The output for the command `debug bfd event` is the same as the log messages that appear on the console by default.

Border Gateway Protocol IPv4 (BGPv4)

Border Gateway Protocol IPv4 (BGPv4) version 4 (BGPv4) is supported on platforms: e c s

S4810 **S4820T**

Platforms support BGP according to the following table:

| FTOS version | Platform support | |
|--------------|--------------------|----------------|
| 8.3.19.0 | S4820T | S4820T |
| 8.3.11.1 | Z9000 | Z |
| 8.3.7.0 | S4810 | S4810 |
| 8.1.1.0 | E-Series ExaScale | e _x |
| 7.8.1.0 | S-Series | S |
| 7.7.1.0. | C-Series | C |
| pre-7.7.1.0 | E-Series TeraScale | e _t |

This chapter is intended to provide a general description of Border Gateway Protocol version 4 (BGPv4) as it is supported in the Dell Force10 Operating System (FTOS).

This chapter includes the following topics:

- Protocol Overview
 - Autonomous Systems (AS)
 - Sessions and Peers
 - Route Reflectors
 - Confederations
- BGP Attributes
 - Best Path Selection Criteria
 - Weight
 - Local Preference
 - Multi-Exit Discriminators (MEDs)
 - AS Path

- Next Hop
- Multiprotocol BGP
- Implementing BGP with FTOS
 - Advertise IGP cost as MED for redistributed routes
 - Ignore Router-ID for some best-path calculations
 - 4-Byte AS Numbers
 - AS4 Number Representation
 - AS Number Migration
 - BGP4 Management Information Base (MIB)
 - Important Points to Remember
- Configuration Information
 - Configuration Task List for BGP
 - MBGP Configuration
 - Storing Last and Bad PDUs
 - Capturing PDUs
 - PDU Counters
- Sample Configurations

BGP protocol standards are listed in the [Chapter 56, Standards Compliance](#) chapter.

Protocol Overview

Border Gateway Protocol (BGP) is an external gateway protocol that transmits interdomain routing information within and between [Autonomous Systems \(AS\)](#). Its primary function is to exchange network reachability information with other BGP systems. BGP generally operates with an Internal Gateway Protocol (IGP) such as OSPF or RIP, allowing you to communicate to external ASs smoothly. BGP adds reliability to network connections by having multiple paths from one router to another.

Autonomous Systems (AS)

BGP Autonomous Systems (ASs) are a collection of nodes under common administration, with common network routing policies. Each AS has a number, already assigned by an internet authority. You do not assign the BGP number.

AS Numbers (ASNs) are important because the ASN uniquely identifies each network on the Internet. The [IANA](#) has reserved AS numbers 64512 through 65534 to be used for private purposes. The ASNs 0 and 65535 are reserved by the IANA and should not be used in a live environment.

Autonomous Systems can be grouped into three categories, defined by their connections and operation.

A **multihomed** AS is one that maintains connections to more than one other AS. This allows the AS to remain connected to the internet in the event of a complete failure of one of their connections. However, this type of AS does not allow traffic from one AS to pass through on its way to another AS. A simple example of this is seen in the illustration below.

A **stub** AS is one that is connected to only one other AS.

A **transit** AS is one that provides connections through itself to separate networks. For example as seen in the illustration below, Router 1 can use Router 2 (the transit AS) to connect to Router 4. ISPs are always transit ASs, because they provide connections from one network to another. The ISP is considered to be “selling transit service” to the customer network, so thus the term Transit AS.

When BGP operates inside an Autonomous System (AS1 or AS2 as seen in the illustration below), it is referred to as Internal BGP (IBGP *Interior Border Gateway Protocol*). When BGP operates between Autonomous Systems (AS1 and AS2), it is called External BGP (EBGP *Exterior Border Gateway Protocol*). IBGP provides routers inside the AS with the knowledge to reach routers external to the AS. EBGP routers exchange information with other EBGP routers as well as IBGP routers to maintain connectivity and accessibility.

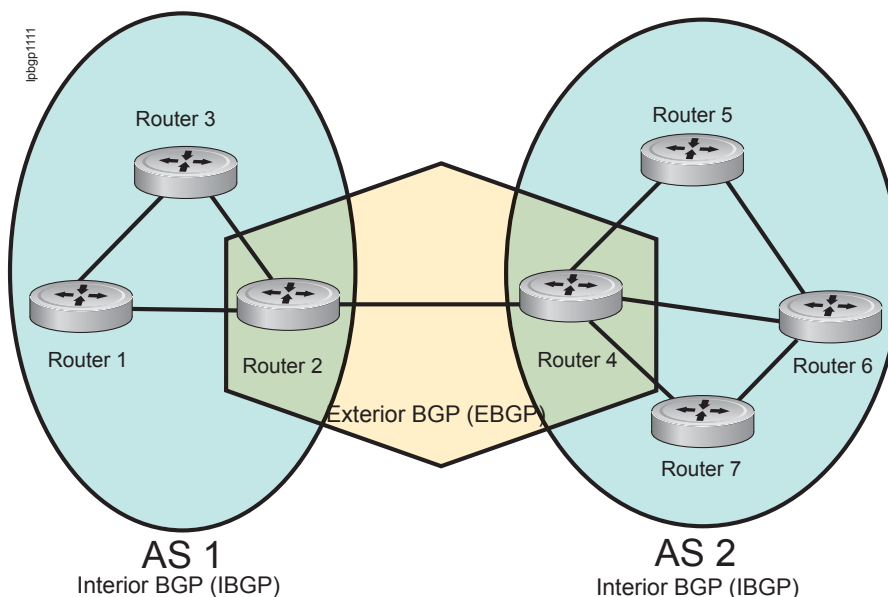

BGP version 4 (BGPv4) supports classless interdomain routing and aggregate routes and AS paths. BGP is a path vector protocol - a computer network in which BGP maintains the path that update information takes as it diffuses through the network. Updates traveling through the network and returning to the same node are easily detected and discarded.

BGP does not use traditional Interior Gateway Protocol (IGP) matrix, but makes routing decisions based on path, network policies and/or rulesets. Unlike most protocols, BGP uses TCP as its transport protocol.

Since each BGP routers talking to another router is a session, a BGP network needs to be in “full mesh”. This is a topology that has every router directly connected to every other router. For example, as seen in the illustration below, four routers connected in a full mesh have three peers each, six routers have five peers each, and eight routers in full mesh will have seven peers each.

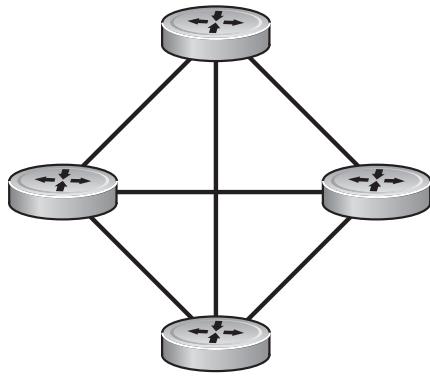

4 Routers

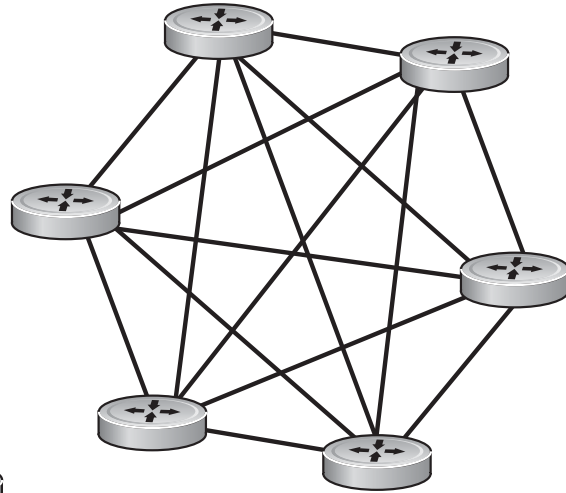

6 Routers

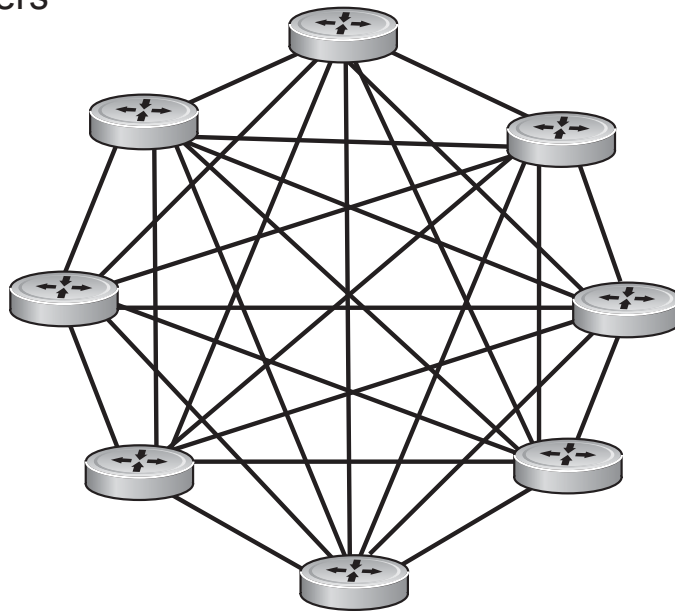

8 Routers

The number of BGP speakers each BGP peer must maintain increases exponentially. Network management quickly becomes impossible.

Sessions and Peers

When two routers communicate using the BGP protocol, a BGP session is started. The two end-points of that session are Peers. A Peer is also called a Neighbor.

Establishing a session

Information exchange between peers is driven by events and timers. The focus in BGP is on the traffic routing policies.

In order to make decisions in its operations with other BGP peers, a BGP peer uses a simple finite state machine that consists of six states: Idle, Connect, Active, OpenSent, OpenConfirm, and Established. For each peer-to-peer session, a BGP implementation tracks which of these six states the session is in. The BGP protocol defines the messages that each peer should exchange in order to change the session from one state to another.

The first state is the **Idle** mode. BGP initializes all resources, refuses all inbound BGP connection attempts, and initiates a TCP connection to the peer.

The next state is **Connect**. In this state the router waits for the TCP connection to complete, transitioning to the **OpenSent** state if successful.

If that transition is not successful, BGP resets the ConnectRetry timer and transitions to the **Active** state when the timer expires.

In the **Active** state, the router resets the ConnectRetry timer to zero, and returns to the **Connect** state.

Upon successful **OpenSent** transition, the router sends an Open message and waits for one in return.

Once the Open message parameters are agreed between peers then the neighbor relation is established and is in **Open confirm** state. This is when the router receives and checks for agreement on the parameters of open messages to establish a session.

Keepalive messages are exchanged next, and upon successful receipt, the router is placed in the **Established** state. Keepalive messages continue to be sent at regular periods (established by the Keepalive timer) to verify connections.

Once established, the router can now send/receive Keepalive, Update, and Notification messages to/from its peer.

Peer Groups

Peer Groups are neighbors grouped according to common routing policies. They enable easier system configuration and management by allowing groups of routers to share and inherit policies.

Peer groups also aid in convergence speed. When a BGP process needs to send the same information to a large number of peers, it needs to set up a long output queue to get that information to all the proper peers. If they are members of a peer group, however, the information can be sent to one place then passed onto the peers within the group.

Route Reflectors

Route Reflectors reorganize the iBGP core into a hierarchy and allow some route advertisement rules.

Route reflection divides iBGP peers into two groups: client peers and nonclient peers. A route reflector and its client peers form a route reflection cluster. Since BGP speakers announce only the best route for a given prefix, route reflector rules are applied after the router makes its best path decision.

- If a route was received from a nonclient peer, reflect the route to all client peers.
- If the route was received from a client peer, reflect the route to all nonclient and all client peers.

To illustrate how these rules affect routing, refer to the illustration below and the following steps. Routers B, C, D, E, and G are members of the same AS - AS100. These routers are also in the same Route Reflection Cluster, where Router D is the Route Reflector. Router E and H are client peers of Router D; Routers B and C and nonclient peers of Router D.

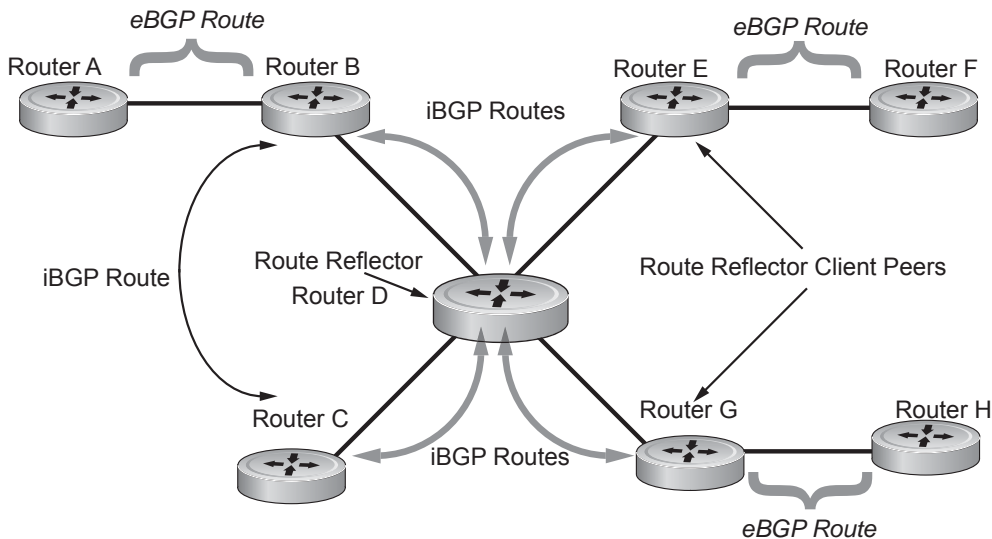

1. Router B receives an advertisement from Router A through eBGP. Since the route is learned through eBGP, Router B advertises it to all its iBGP peers: Routers C and D.
2. Router C receives the advertisement but does not advertise it to any peer because its only other peer is Router D, an iBGP peer, and Router D has already learned it through iBGP from Router B.
3. Router D does not advertise the route to Router C because Router C is a nonclient peer and the route advertisement came from Router B who is also a non-client peer.
4. Router D does reflect the advertisement to Routers E and G because they are client peers of Router D.
5. Routers E and G then advertise this iBGP learned route to their eBGP peers Routers F and H.

Confederations

Communities

BGP communities are sets of routes with one or more common attributes. This is a way to assign common attributes to multiple routes at the same time.

BGP Attributes

Routes learned via BGP have associated properties that are used to determine the best route to a destination when multiple paths exist to a particular destination. These properties are referred to as BGP attributes, and an understanding of how BGP attributes influence route selection is required for the design of robust networks. This section describes the attributes that BGP uses in the route selection process:

- Weight
- Local Preference
- Multi-Exit Discriminators (MEDs)
- Origin
- AS Path
- Next Hop

Best Path Selection Criteria

Paths for active routes are grouped in ascending order according to their neighboring external AS number (BGP best path selection is deterministic by default, which means the **bgp non-deterministic-med** command is NOT applied).

The best path in each group is selected based on specific criteria. Only one “best path” is selected at a time. If any of the criteria results in more than one path, BGP moves on to the next option in the list. For example, two paths may have the same weights, but different local preferences. BGP sees that the Weight criteria results in two potential “best paths” and moves to local preference to reduce the options. If a number of best paths is determined, this selection criteria is applied to group’s best to determine the ultimate best path.

In non-deterministic mode (the **bgp non-deterministic-med** command is applied), paths are compared in the order in which they arrive. This method can lead to FTOS choosing different best paths from a set of paths, depending on the order in which they were received from the neighbors, since MED may or may not get compared between adjacent paths. In deterministic mode, FTOS compares MED between adjacent paths within an AS group since all paths in the AS group are from the same AS.



Note: In 8.3.12.0, the **bgp bestpath as-path multipath-relax** command is disabled by default, preventing BGP from load-balancing a learned route across two or more eBGP peers. To enable load-balancing across different eBGP peers, enable the **bgp bestpath as-path multipath-relax** command.

A system error will result if the **bgp bestpath as-path ignore** command and the **bgp bestpath as-path multipath-relax** command are configured at the same time. Only enable one command at a time.

The following image illustrates the decisions BGP goes through to select the best path. The list following the illustration details the path selection criteria.

Figure 9-1. BGP Best Path Selection

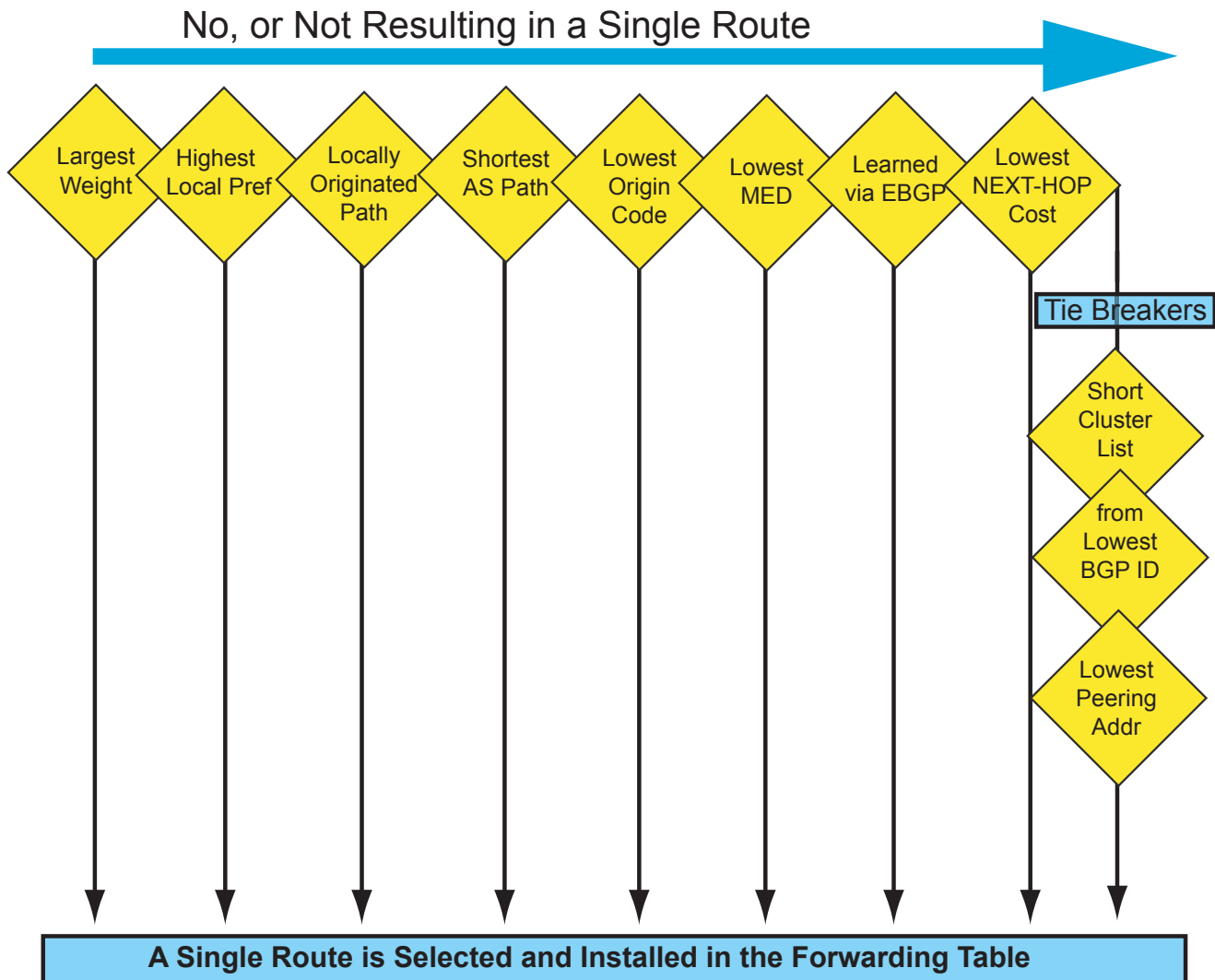

Best Path selection details

1. Prefer the path with the largest WEIGHT attribute.
2. Prefer the path with the largest LOCAL_PREF attribute.
3. Prefer the path that was locally Originated via a **network** command, **redistribute** command or **aggregate-address** command.
 - Routes originated with the **network** or **redistribute** commands are preferred over routes originated with the **aggregate-address** command.
4. Prefer the path with the shortest AS_PATH (unless the **bgp bestpath as-path ignore** command is configured, then AS_PATH is not considered). The following criteria apply:
 - An AS_SET has a path length of 1, no matter how many ASs are in the set.
 - A path with no AS_PATH configured has a path length of 0.
 - AS_CONFED_SET is not included in the AS_PATH length.

- AS_CONFED_SEQUENCE has a path length of 1, no matter how many ASs are in the AS_CONFED_SEQUENCE.
5. Prefer the path with the lowest ORIGIN type (IGP is lower than EGP, and EGP is lower than INCOMPLETE).
 6. Prefer the path with the lowest Multi-Exit Discriminator (MED) attribute. The following criteria apply:
 - This comparison is only done if the first (neighboring) AS is the same in the two paths; the MEDs are compared only if the first AS in the AS_SEQUENCE is the same for both paths.
 - If the **bgp always-compare-med** command is entered, MEDs are compared for all paths.
 - Paths with no MED are treated as “worst” and assigned a MED of 4294967295.
 7. Prefer external (EBGP) to internal (IBGP) paths or confederation EBGP paths.
 8. Prefer the path with the lowest IGP metric to the BGP next-hop is selected when synchronization is disabled and only an internal path remains.
 9. FTOS deems the paths as equal and does not perform steps 9 through 11 listed below, if the following criteria is met:
 - the IBGP multipath or EBGP multipath are configured (**maximum-path** command)
 - the paths being compared were received from the same AS with the same number of ASs in the AS Path but with different NextHops
 - the paths were received from IBGP or EBGP neighbor respectively
 10. If the **bgp bestpath router-id ignore** command is enabled and:
 - If the Router-ID is the same for multiple paths (because the routes were received from the same route) skip this step.
 - If the Router-ID is NOT the same for multiple paths, Prefer the path that was first received as the Best Path. The path selection algorithm should return without performing any of the checks outlined below.
 11. Prefer the path originated from the BGP router with the lowest router ID. For paths containing a Route Reflector (RR) attribute, the originator ID is substituted for the router ID.
 12. If two paths have the same router ID, prefer the path with the lowest cluster ID length. Paths without a cluster ID length are set to a 0 cluster ID length.
 13. Prefer the path originated from the neighbor with the lowest address. (The neighbor address is used in the BGP neighbor configuration, and corresponds to the remote peer used in the TCP connection with the local router.)

After a number of best paths is determined, this selection criteria is applied to group’s best to determine the ultimate best path.

In non-deterministic mode (the **bgp non-deterministic-med** command is applied), paths are compared in the order in which they arrive. This method can lead to FTOS choosing different best paths from a set of paths, depending on the order in which they were received from the neighbors since MED may or may not get compared between adjacent paths. In deterministic mode, FTOS compares MED between adjacent paths within an AS group since all paths in the AS group are from the same AS.

Weight

The Weight attribute is local to the router and is not advertised to neighboring routers. If the router learns about more than one route to the same destination, the route with the highest weight will be preferred. The route with the highest weight is installed in the IP routing table.

Local Preference

Local Preference (LOCAL_PREF) represents the degree of preference within the entire AS. The higher the number, the greater the preference for the route.

The Local Preference (LOCAL_PREF) is one of the criteria used to determine the best path, so keep in mind that other criteria may impact selection, as shown in the illustration in [Best Path Selection Criteria](#). For this example, assume that LOCAL_PREF is the only attribute applied. In the illustration below, AS100 has two possible paths to AS 200. Although the path through the Router A is shorter (one hop instead of two) the LOCAL_PREF settings have the preferred path go through Router B and AS300. This is advertised to all routers within AS100 causing all BGP speakers to prefer the path through Router B.

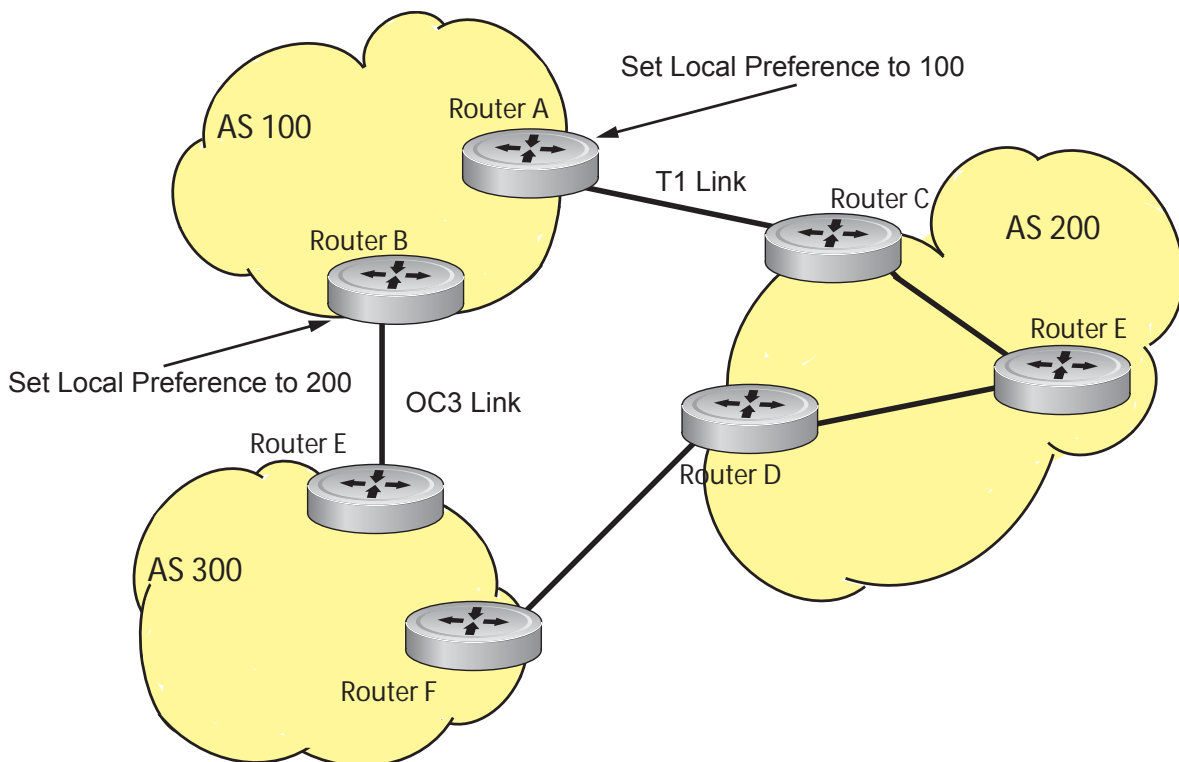

Multi-Exit Discriminators (MEDs)

If two Autonomous Systems (AS) connect in more than one place, a Multi-Exit Discriminator (MED) can be used to assign a preference to a preferred path. The MED is one of the criteria used to determine the best path, so keep in mind that other criteria may impact selection, as shown in the illustration in [Best Path Selection Criteria](#).

One AS assigns the MED a value and the other AS uses that value to decide the preferred path. For this example, assume the MED is the only attribute applied. In the following illustration, AS100 and AS200 connect in two places. Each connection is a BGP session. AS200 sets the MED for its T1 exit point to 100 and the MED for its OC3 exit point to 50. This sets up a path preference through the OC3 link. The MEDs are advertised to AS100 routers so they know which is the preferred path.

An MED is a non-transitive attribute. If AS100 sends an MED to AS200, AS200 does not pass it on to AS300 or AS400. The MED is a locally relevant attribute to the two participating Autonomous Systems (AS100 and AS200).

Note that the MEDs are advertised across both links, so that if a link goes down AS 1 still has connectivity to AS300 and AS400.

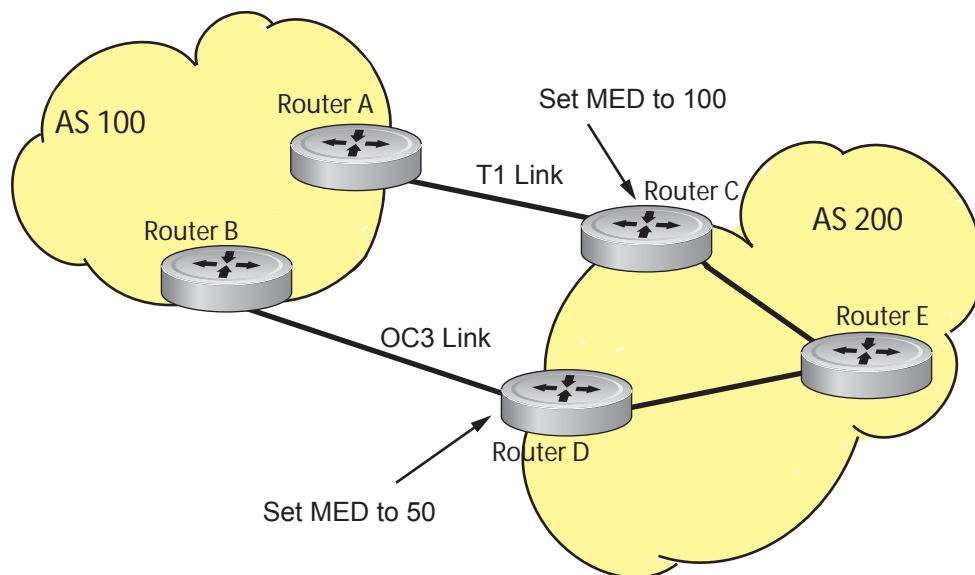

Note: With FTOS Release 8.3.1.0, configuring the **set metric-type internal** command in a route-map advertises the IGP cost as MED to outbound EBGP peers when redistributing routes. The configured **set metric** value overwrites the default IGP cost.

Origin

The Origin indicates the origin of the prefix, or how the prefix came into BGP. There are three Origin codes: IGP, EGP, INCOMPLETE.

- IGP indicated the prefix originated from information learned through an interior gateway protocol.
- EGP indicated the prefix originated from information learned from an EGP protocol, which NGP replaced.
- INCOMPLETE indicates that the prefix originated from an unknown source.

Generally, an IGP indicator means that the route was derived inside the originating AS. EGP generally means that a route was learned from an external gateway protocol. An INCOMPLETE origin code generally results from aggregation, redistribution or other indirect ways of installing routes into BGP.

In FTOS, these origin codes appear as shown in the example below. The question mark (?) indicates an Origin code of INCOMPLETE. The lower case letter (i) indicates an Origin code of IGP.

```
FTOS#show ip bgp
BGP table version is 0, local router ID is 10.101.15.13
Status codes: s suppressed, d damped, h history, * valid, > best
Path source: I - internal, a - aggregate, c - confed-external, r - redistributed, n - network
Origin codes: i - IGP, e - EGP, ? - incomplete
```

| | Network | Next Hop | Metric | LocPrf | Weight | Path |
|----|------------|-------------|--------|--------|--------|-------|
| *> | 7.0.0.0/29 | 10.114.8.33 | 0 | 0 | 18508 | ? |
| *> | 7.0.0.0/30 | 10.114.8.33 | 0 | 0 | 18508 | ? |
| *> | 9.2.0.0/16 | 10.114.8.33 | 10 | 0 | 18508 | 701 i |

AS Path

The AS Path is the list of all Autonomous Systems that all the prefixes listed in the update have passed through. The local AS number is added by the BGP speaker when advertising to a eBGP neighbor.

In FTOS the AS Path is shown in the following example. Note that the Origin attribute is shown following the AS Path information.

```
FTOS#show ip bgp paths
Total 30655 Paths
Address      Hash Refcount Metric Path
0x4014154    0          3 18508 701 3549 19421 i
0x4013914    0          3 18508 701 7018 14990 i
0x5166d6c    0          3 18508 209 4637 1221 9249 9249 i
0x5e62df4    0          2 18508 701 17302 i
0x3a1814c    0         26 18508 209 22291 i
0x567ea9c    0         75 18508 209 3356 2529 i
0x6cc1294    0          2 18508 209 1239 19265 i
0x6cc18d4    0          1 18508 701 2914 4713 17935 i
0x5982e44    0        162 18508 209 i
0x67d4a14    0          2 18508 701 19878 ?
0x559972c    0         31 18508 209 18756 i
0x59cd3b4    0          2 18508 209 7018 15227 i
0x7128114    0         10 18508 209 3356 13845 i
0x536a914    0          3 18508 209 701 6347 7781 i
0x2ffe884    0          1 18508 701 3561 9116 21350 i
```

Next Hop

The Next Hop is the IP address used to reach the advertising router. For EBGP neighbors, the Next-Hop address is the IP address of the connection between the neighbors. For IBGP, the EBGP Next-Hop address is carried into the local AS. A Next Hop attribute is set when a BGP speaker advertises itself to another BGP speaker outside its local AS. It can also be set when advertising routes within an AS. The Next Hop attribute also serves as a way to direct traffic to another BGP speaker, rather than waiting for a speaker to advertise.

FTOS allows you to set the Next Hop attribute in the CLI. Setting the Next Hop attribute lets you determine a router as the next hop for a BGP neighbor.

Multiprotocol BGP

MBGP for IPv6 unicast is supported on platforms `e C`

MBGP for IPv4 Multicast is supported on platform `C e S`

Multiprotocol Extensions for BGP (MBGP) is defined in IETF RFC 2858. MBGP allows different types of address families to be distributed in parallel. This allows information about the topology of IP Multicast-capable routers to be exchanged separately from the topology of normal IPv4 and IPv6 unicast routers. It allows a multicast routing topology different from the unicast routing topology.



Note: It is possible to configure BGP peers that exchange both unicast and multicast network layer reachability information (NLRI), but you cannot connect Multiprotocol BGP with BGP. Therefore, you cannot redistribute Multiprotocol BGP routes into BGP.

Implementing BGP with FTOS

Additional Path (Add-Path) support

The Add-path feature reduces convergence times by advertising multiple paths to its peers for the same address prefix without replacing existing paths with new ones. By default, a BGP speaker advertises only the best path to its peers for a given address prefix. If the best path becomes unavailable, the BGP speaker withdraws its path from its local RIB and recalculates a new best path. This requires both IGP and BGP convergence and can therefore be a lengthy process.

BGP add-path on FTOS reduces the time taken for BGP convergence by advertising multiple paths to its peers for the same address prefix without new paths implicitly replacing the existing paths. An iBGP speaker that receives multiple paths from its peers should calculate the best path in its own. BGP add-path helps switchover to next new best path based on IGP convergence time when best path becomes unavailable.

Advertise IGP cost as MED for redistributed routes

When using multipath connectivity to an external AS, you can advertise the MED value selectively to each peer for redistributed routes. For some peers you can set the internal/IGP cost as the MED while setting others to a constant pre-defined metric as MED value.

FTOS 8.3.1.0 and later support configuring the **set metric-type internal** command in a route-map to advertise the IGP cost as the MED to outbound EBGP peers when redistributing routes. The configured **set metric** value overwrites the default IGP cost.

By using the **redistribute** command in conjunction with the **route-map** command, you can specify whether a peer advertises the standard MED or uses the IGP cost as the MED.

Note the following when configuring this functionality:

- If the **redistribute** command does not have any **metric** configured and BGP Peer out-bound route-map does have **metric-type internal** configured, BGP advertises the IGP cost as MED.
- If the **redistribute** command has **metric** configured (**route-map set metric** or **redistribute route-type metric**) and the BGP Peer out-bound route-map has **metric-type internal** configured, BGP advertises the metric configured in the redistribute command as MED.
- If BGP peer out-bound route-map has **metric** configured, then all other metrics are overwritten by this.



Note: When redistributing static, connected or OSPF routes, there is no metric option. Simply assign the appropriate route-map to the redistributed route.

Table 9-1, "Example MED advertisement," in Border Gateway Protocol IPv4 (BGPv4) gives some examples of these rules.

Table 9-1. Example MED advertisement

| Command Settings | BGP Local Routing Information Base | MED Advertised to Peer | |
|---|------------------------------------|-------------------------------------|--|
| | | WITH route-map metric-type internal | WITHOUT route-map metric-type internal |
| redistribute <i>isis</i> (IGP cost = 20) | MED: IGP cost 20 | MED = 20 | MED = 0 |
| redistribute <i>isis</i> route-map set metric 50 | MED: IGP cost 50 | MED: 50 | MED: 50 |
| redistribute <i>isis</i> metric 100 | MED: IGP cost 100 | MED: 100 | MED: 100 |

Ignore Router-ID for some best-path calculations

FTOS 8.3.1.0 and later allow you to avoid unnecessary BGP best-path transitions between external paths under certain conditions. The **bgp bestpath router-id ignore** command reduces network disruption caused by routing and forwarding plane changes and allows for faster convergence.

4-Byte AS Numbers

FTOS Version 7.7.1 and later support 4-Byte (32-bit) format when configuring Autonomous System Numbers (ASNs). The 4-Byte support is advertised as a new BGP capability (4-BYTE-AS) in the OPEN message. If a 4-Byte BGP speaker has sent and received this capability from another speaker, all the messages will be 4-octet. The behavior of a 4-Byte BGP speaker will be different with the peer depending on whether the peer is 4-Byte or 2-Byte BGP speaker.

Where the 2-Byte format is 1-65535, the 4-Byte format is 1-4294967295. Enter AS Numbers using the traditional format. If the ASN is greater than 65535, the dot format is shown when using the **show ip bgp** commands. For example, an ASN entered as 3183856184 will appear in the show commands as 48581.51768; an ASN of 65123 is shown as 65123. To calculate the comparable dot format for an ASN from a traditional format, use **ASN/65536.ASN%65536**.

Table 9-2. 4-Byte ASN Dot Format Examples

| Traditional Format | | Dot Format |
|--------------------|---------|-------------|
| 65001 | Is | 0.65501 |
| 65536 | The | 1.0 |
| 100000 | Same As | 1.34464 |
| 4294967295 | | 65535.65535 |

When creating **Confederations**, all the routers in a Confederation must be either 4-Byte or 2-Byte identified routers. You cannot mix them.

Configure the 4-byte AS numbers with the **four-octet-support** command.

AS4 Number Representation

FTOS version 8.2.1.0 supports multiple representations of an 4-byte AS Numbers: **asplain**, **asdot+**, and **asdot**.



Note: The ASDOT and ASDOT+ representations are supported only in conjunction with the **4-Byte AS Numbers** feature. If 4-Byte AS Numbers are not implemented, only ASPLAIN representation is supported.

ASPLAIN is the method FTOS has used for all previous FTOS versions. It remains the default method with FTOS 8.2.1.0 and later. With the ASPLAIN notation, a 32 bit binary AS number is translated into a decimal value.

- All AS Numbers between 0-65535 are represented as a decimal number when entered in the CLI as well as when displayed in the show command outputs.
- AS Numbers larger than 65535 are represented using ASPLAIN notation as well. 65546 is represented as 65546.

ASDOT+ representation splits the full binary 4-byte AS number into two words of 16 bits separated by a decimal point (.): <high-order 16 bit value>.<low-order 16 bit value>. Some examples are shown in [Table 9-2, "4-Byte ASN Dot Format Examples," in Border Gateway Protocol IPv4 \(BGPv4\)](#).

- All AS Numbers between 0-65535 are represented as a decimal number, when entered in the CLI as well as when displayed in the show command outputs.
- AS Numbers larger than 65535 is represented using ASDOT notation as <higher 2 bytes in decimal>.<lower 2 bytes in decimal>. For example: AS 65546 is represented as 1.10.

ASDOT representation combines the ASPLAIN and ASDOT+ representations. AS Numbers less than 65536 appear in integer format (asplain); AS Numbers equal to or greater than 65536 appear using the decimal method (asdot+). For example, the AS Number 65526 appears as 65526, and the AS Number 65546 appears as 1.10.

Dynamic AS Number Notation application

FTOS 8.3.1.0 applies the ASN Notation type change dynamically to the running-config statements. When you apply or change an asnotation, the type selected is reflected immediately in the running-configuration and the show commands (refer to the following two examples).

Dynamic changes of the bgp asnotation command in the show running config

```
ASDOT
FTOS(conf-router_bgp)#bgp asnotation asdot
FTOS(conf-router_bgp)#show conf
!
router bgp 100
  bgp asnotation asdot
  bgp four-octet-as-support
neighbor 172.30.1.250 local-as 65057
<output truncated>

FTOS(conf-router_bgp)#do show ip bgp
BGP table version is 24901, local router ID is 172.30.1.57
<output truncated>
```

```
ASDOT+
FTOS(conf-router_bgp)#bgp asnotation asdot+
FTOS(conf-router_bgp)#show conf
!
router bgp 100
  bgp asnotation asdot+
  bgp four-octet-as-support
neighbor 172.30.1.250 local-as 65057
<output truncated>

FTOS(conf-router_bgp)#do show ip bgp
BGP table version is 31571, local router ID is 172.30.1.57
<output truncated>
```

```
AS-PLAIN
FTOS(conf-router_bgp)#bgp asnotation asplain
FTOS(conf-router_bgp)#sho conf
!
router bgp 100
  bgp four-octet-as-support
neighbor 172.30.1.250 local-as 65057
<output truncated>

FTOS(conf-router_bgp)#do sho ip bgp
BGP table version is 34558, local router ID is 172.30.1.57
<output truncated>
```

Dynamic changes when bgp asnotation command is disabled in the show running config

```
AS NOTATION DISABLED
FTOS(conf-router_bgp)#no bgp asnotation
FTOS(conf-router_bgp)#sho conf
!
router bgp 100
  bgp four-octet-as-support
neighbor 172.30.1.250 local-as 65057
<output truncated>

FTOS(conf-router_bgp)#do sho ip bgp
BGP table version is 28093, local router ID is 172.30.1.57
```

```
AS4 SUPPORT DISABLED
FTOS(conf-router_bgp)#no bgp four-octet-as-support
FTOS(conf-router_bgp)#sho conf
!
router bgp 100
neighbor 172.30.1.250 local-as 65057

FTOS(conf-router_bgp)#do show ip bgp
BGP table version is 28093, local router ID is 172.30.1.57
```

AS Number Migration

When migrating one AS to another, perhaps combining ASs, an eBGP network may lose its routing to an iBGP if the ASN changes. Migration can be difficult as all the iBGP and eBGP peers of the migrating network need to be updated to maintain network reachability. With this feature you can transparently change the AS number of entire BGP network and ensure that the routes are propagated throughout the network while the migration is in progress. Essentially, **Local-AS** provides a capability to the BGP speaker to operate as if it belongs to "virtual" AS network besides its physical AS network.

The following illustration shows a scenario where Router A, Router B and Router C belong to AS 100, 200, 300 respectively. Router A acquired Router B; Router B has Router C as its customer. When Router B is migrating to Router A, it needs to maintain the connection with Router C without immediately updating Router C's configuration. **Local-AS** allows this to happen by allowing Router B to appear as if it still belongs to Router B's old network (AS 200) as far as communicating with Router C is concerned.

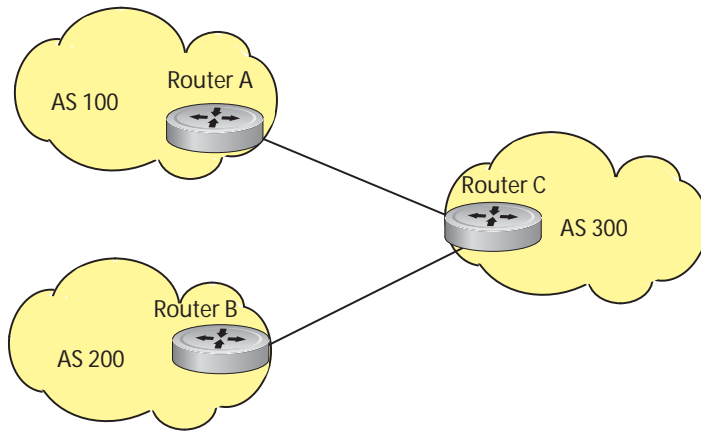

Before Migration

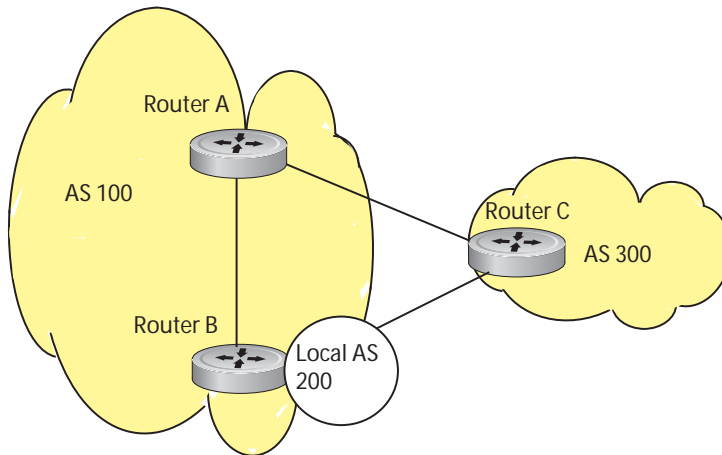

After Migration, with Local-AS enabled

When you complete your migration, and you have reconfigured your network with the new information you must disable this feature.

If the “no prepend” option is used, the local-as will not be prepended to the updates received from the eBGP peer. If “no prepend” is not selected (the default), the local-as is added to the first AS segment in the AS-PATH. If an inbound route-map is used to prepend the as-path to the update from the peer, the local-as is added first. For example, consider the topology described in the illustration above. If Router B has an inbound route-map applied on Router C to prepend "65001 65002" to the as-path, the following events will take place on Router B

1. Receive and validate the update
2. Prepend local-as 200 to as-path
3. Prepend "65001 65002" to as-path

Local-as is prepended before the route-map to give an impression that update passed thru a router in AS 200 before it reached Router B.

BGP4 Management Information Base (MIB)

The FORCE10-BGP4-V2-MIB enhances FTOS BGP Management Information Base (MIB) support with many new SNMP objects and notifications (traps) defined in the *draft-ietf-idr-bgp4-mibv2-05*. To see these enhancements, download the MIB from the Dell Force10 website, www.force10networks.com.



Note: Refer to the Dell Force10 iSupport webpage for the *Force10-BGP4-V2-MIB* and other MIB documentation.

Important Points to Remember

- In `f10BgpM2AsPathTableEntry` table, `f10BgpM2AsPathSegmentIndex`, and `f10BgpM2AsPathElementIndex` are used to retrieve a particular ASN from the AS path. These indices are assigned to the AS segments and individual ASN in each segment starting from 0. For example, an AS path list of {200 300 400} 500 consists of two segments: {200 300 400} with segment index 0 and 500 with segment index 1. ASN 200, 300, and 400 are assigned 0, 1, and 2 element indices in that order.
- Unknown optional transitive attributes within a given path attribute (PA) are assigned indices in order. These indices correspond to `f10BgpM2PathAttrUnknownIndex` field in the `f10BgpM2PathAttrUnknownEntry` table.
- Negotiation of multiple instances of the same capability is not supported. `F10BgpM2PeerCapAnnouncedIndex` and `f10BgpM2PeerCapReceivedIndex` are ignored in the peer capability lookup.
- Inbound BGP soft-reconfiguration must be configured on a peer for `f10BgpM2PrefixInPrefixesRejected` to display the number of prefixes filtered due to a policy. If BGP soft-reconfig is not enabled, the denied prefixes are not accounted for.
- `F10BgpM2AdjRibsOutRoute` stores the pointer to the NLRI in the peer's Adj-Rib-Out.
- PA Index (`f10BgpM2PathAttrIndex` field in various tables) is used to retrieve specific attributes from the PA table. The Next-Hop, RR Cluster-list, Originator ID attributes are not stored in the PA Table and cannot be retrieved using the index passed in. These fields are not populated in `f10BgpM2PathAttrEntry`, `f10BgpM2PathAttrClusterEntry`, `f10BgpM2PathAttrOriginatorIdEntry`.
- `F10BgpM2PathAttrUnknownEntry` contains the optional-transitive attribute details.
- Query for `f10BgpM2LinkLocalNextHopEntry` returns default value for Link-local Next-hop.
- RFC 2545 and the `f10BgpM2Rfc2545Group` are not supported.
- An SNMP query will display up to 89 AS paths. A query for a larger AS path count will display as "... " at the end of the output.
- SNMP set for BGP is not supported. For all peer configuration tables (`f10BgpM2PeerConfigurationGroup`, `f10BgpM2PeerRouteReflectorCfgGroup`, and `f10BgpM2PeerAsConfederationCfgGroup`), an SNMP set operation will return an error. Only SNMP queries are supported. In addition, the `f10BgpM2CfgPeerError`, `f10BgpM2CfgPeerBgpPeerEntry`, and `f10BgpM2CfgPeerRowEntryStatus` fields are to hold the SNMP set status and are ignored in SNMP query.
- The AFI/SAFI is not used as an index to the `f10BgpM2PeerCountersEntry` table. The BGP peer's AFI/SAFI (IPv4 Unicast or IPv6 Multicast) is used for various outbound counters. Counters corresponding to IPv4 Multicast cannot be queried.

- The f10BgpM2[Cfg]PeerReflectorClient field is populated based on the assumption that route-reflector clients are not in a full mesh if BGP client-2-client reflection is enabled and that the BGP speaker acting as reflector will advertise routes learned from one client to another client. If disabled, it is assumed that clients are in a full mesh, and there is no need to advertise prefixes to the other clients.
- High CPU utilization may be observed during an SNMP walk of a large BGP Loc-RIB.
- To avoid SNMP timeouts with a large-scale configuration (large number of BGP neighbors and a large BGP Loc-RIB), Dell Force10 recommends setting the timeout and retry count values to a relatively higher number. e.g. t = 60 or r = 5.
- To return all values on an snmpwalk for the f10BgpM2Peer sub-OID, use the -C c option, such as snmpwalk -v 2c -C c -c public <IP_address> <OID>.
- An SNMP walk may terminate pre-maturely if the index does not increment lexicographically. Dell Force10 recommends using options to ignore such errors.
- Multiple BGP process instances are not supported. Thus, the F10BgpM2PeerInstance field in various tables is not used to locate a peer.
- Multiple instances of the same NLRI in the BGP RIB are not supported and are set to zero in the SNMP query response.
- F10BgpM2NlriIndex and f10BgpM2AdjRibsOutIndex fields are not used.
- Carrying MPLS labels in BGP is not supported. F10BgpM2NlriOpaqueType and f10BgpM2NlriOpaquePointer fields are set to zero.
- 4-byte ASN is supported. f10BgpM2AsPath4byteEntry table contains 4-byte ASN-related parameters based on the configuration.

Traps (notifications) specified in the BGP4 MIB draft <draft-ietf-idr-bgp4-mibv2-05.txt> are not supported. Such traps (bgpM2Established and bgpM2BackwardTransition) are supported as part of RFC 1657.

Configuration Information

The software supports BGPv4 as well as the following:

- deterministic multi-exit discriminator (MED) (default)
- a path with a missing MED is treated as worst path and assigned an MED value of (0xffffffff)
- the community format follows RFC 1998
- delayed configuration (the software at system boot reads the entire configuration file prior to sending messages to start BGP peer sessions)

The following are not yet supported:

- auto-summarization (the default is no auto-summary)
- synchronization (the default is no synchronization)

BGP Configuration

To enable the BGP process and begin exchanging information, you must assign an AS number and use commands in the ROUTER BGP mode to configure a BGP neighbor.

Defaults

By default, BGP is disabled.

By default, FTOS compares the MED attribute on different paths from within the same AS (the **bgp always-compare-med** command is not enabled).



Note: In FTOS, all newly configured neighbors and peer groups are disabled. You must enter the **neighbor** *{ip-address | peer-group-name}* **no shutdown** command to enable a neighbor or peer group.

Table 9-3, "FTOS BGP Defaults," in *Border Gateway Protocol IPv4 (BGPv4)* displays the default values for BGP on FTOS.

Table 9-3. FTOS BGP Defaults

| Item | Default |
|--------------------------------|--|
| BGP Neighbor Adjacency changes | All BGP neighbor changes are logged. |
| Fast External Fallover feature | Enabled |
| graceful restart feature | Disabled |
| Local preference | 100 |
| MED | 0 |
| Route Flap Damping Parameters | half-life = 15 minutes reuse = 750 suppress = 2000 max-suppress-time = 60 minutes |
| Distance | external distance = 20 internal distance = 200 local distance = 200 |
| Timers | keepalive = 60 seconds holdtime = 180 seconds |

Configuration Task List for BGP

The following list includes the configuration tasks for BGP:

- [Enable BGP](#)
- [Configure AS4 Number Representations](#)
- [Configure Peer Groups](#)

- BGP fast fall-over
- Configure passive peering
- Maintain existing AS numbers during an AS migration
- Allow an AS number to appear in its own AS path
- Enable graceful restart
- Filter on an AS-Path attribute
- Configure IP community lists
- Manipulate the COMMUNITY attribute
- Change MED attribute
- Change LOCAL_PREFERENCE attribute
- Change NEXT_HOP attribute
- Change WEIGHT attribute
- Enable multipath
- Filter BGP routes
- Redistribute routes
- Configure BGP route reflectors
- Aggregate routes
- Configure BGP confederations
- Enable route flap dampening
- Change BGP timers
- BGP neighbor soft-reconfiguration
- Route map continue

Enable BGP

By default, BGP is not enabled on the system. FTOS supports one Autonomous System (AS) and you must assign the AS Number (ASN). To establish BGP sessions and route traffic, you must configure at least one BGP neighbor or peer.



In BGP, routers with an established TCP connection are called neighbors or peers. Once a connection is established, the neighbors exchange full BGP routing tables with incremental updates afterwards. In addition, neighbors exchange KEEPALIVE messages to maintain the connection.

In BGP, neighbor routers or peers can be classified as internal or external. External BGP peers must be connected physically to one another (unless you enable the EBGP multihop feature), while internal BGP peers do not need to be directly connected. The IP address of an EBGP neighbor is usually the IP address of the interface directly connected to the router. First, the BGP process determines if all internal BGP peers are reachable, and then it determines which peers outside the AS are reachable.



Note: Sample Configurations for enabling BGP routers are found at the end of this chapter.

Use these commands in the following sequence, starting in the CONFIGURATION mode to establish BGP sessions on the router.

| Step | Command Syntax | Command Mode | Purpose |
|------|--|-------------------|---|
| 1 | router bgp <i>as-number</i> | CONFIGURATION | Assign an AS number and enter the ROUTER BGP mode. AS Number: 0-65535 (2-Byte) or 1-4294967295 (4-Byte) or 0.1-65535.65535 (Dotted format) Only one AS is supported per system |
| |  | | If you enter a 4-Byte AS Number, 4-Byte AS Support is enabled automatically. |
| 1a | bgp four-octet-as-support | CONFIG-ROUTER-BGP | Enable 4-Byte support for the BGP process. Note: This is an OPTIONAL command. Enable if you want to use 4-Byte AS numbers or if you support AS4 Number Representation . |
| |  | | Use it only if you support 4-Byte AS Numbers or if you support AS4 Number Representation . If you are supporting 4-Byte ASNs, this command must be enabled first. Disable 4-Byte support and return to the default 2-Byte format by using the no bgp four-octet-as-support command. You cannot disable 4-Byte support if you currently have a 4-Byte ASN configured. Disabling 4-Byte AS Numbers also disables ASDOT and ASDOT+ number representation. All AS Numbers will be displayed in ASPLAIN format. |
| 1b | address-family [ipv4 ipv6] | CONFIG-ROUTER-BGP | Enable IPv4 multicast or IPv6 mode. Use this command to enter BGP for IPv6 mode (CONF-ROUTER_BGPv6_AF). |
| 2 | neighbor { <i>ip-address</i> <i>peer-group name</i> } remote-as <i>as-number</i> | CONFIG-ROUTER-BGP | Add a neighbor as a remote AS. Formats: IP Address A.B.C.D Peer-Group Name: 16 characters AS-number: 0-65535 (2-Byte) or 1-4294967295 (4-Byte) or 0.1-65535.65535 (Dotted format) You must Configure Peer Groups <i>before</i> assigning it a remote AS. |
| 3 | neighbor { <i>ip-address</i> <i>peer-group-name</i> } no shutdown | CONFIG-ROUTER-BGP | Enable the BGP neighbor. |

 **Note:** When you change the configuration of a BGP neighbor, always reset it by entering the **clear ip bgp** command in EXEC Privilege mode.

Enter **show config** in CONFIGURATION ROUTER BGP mode to view the BGP configuration. Use the **show ip bgp summary** command in EXEC Privilege mode to view the BGP status. The following example shows the summary with a 2-Byte AS Number displayed; the example in [Example: show ip bgp summary \(4-Byte AS Number displayed\)](#) shows the summary with a 4-Byte AS Number displayed.

Example: show ip bgp summary (2-Byte AS Number displayed)

```
R2#show ip bgp summary
BGP router identifier 192.168.10.2, local AS number 65123
BGP table version is 1, main routing table version 1
1 network entrie(s) using 132 bytes of memory
1 paths using 72 bytes of memory
BGP-RIB over all using 73 bytes of memory
1 BGP path attribute entrie(s) using 72 bytes of memory
1 BGP AS-PATH entrie(s) using 47 bytes of memory
5 neighbor(s) using 23520 bytes of memory
```

| Neighbor | AS | MsgRcvd | MsgSent | TblVer | InQ | OutQ | Up/Down | State/Pfx |
|--------------|-------|---------|---------|--------|-----|------|---------|-----------|
| 10.10.21.1 | 65123 | 0 | 0 | 0 | 0 | 0 | never | Active |
| 10.10.32.3 | 65123 | 0 | 0 | 0 | 0 | 0 | never | Active |
| 100.10.92.9 | 65192 | 0 | 0 | 0 | 0 | 0 | never | Active |
| 192.168.10.1 | 65123 | 0 | 0 | 0 | 0 | 0 | never | Active |
| 192.168.12.2 | 65123 | 0 | 0 | 0 | 0 | 0 | never | Active |

R2#

Example: show ip bgp summary (4-Byte AS Number displayed)

```
R2#show ip bgp summary
BGP router identifier 192.168.10.2, local AS number 48735.59224
BGP table version is 1, main routing table version 1
1 network entrie(s) using 132 bytes of memory
1 paths using 72 bytes of memory
BGP-RIB over all using 73 bytes of memory
1 BGP path attribute entrie(s) using 72 bytes of memory
1 BGP AS-PATH entrie(s) using 47 bytes of memory
5 neighbor(s) using 23520 bytes of memory
```

| Neighbor | AS | MsgRcvd | MsgSent | TblVer | InQ | OutQ | Up/Down | State/Pfx |
|--------------|-------|---------|---------|--------|-----|------|---------|-----------|
| 10.10.21.1 | 65123 | 0 | 0 | 0 | 0 | 0 | never | Active |
| 10.10.32.3 | 65123 | 0 | 0 | 0 | 0 | 0 | never | Active |
| 100.10.92.9 | 65192 | 0 | 0 | 0 | 0 | 0 | never | Active |
| 192.168.10.1 | 65123 | 0 | 0 | 0 | 0 | 0 | never | Active |
| 192.168.12.2 | 65123 | 0 | 0 | 0 | 0 | 0 | never | Active |

R2#

For the router's identifier, FTOS uses the highest IP address of the Loopback interfaces configured. Since Loopback interfaces are virtual, they cannot go down, thus preventing changes in the router ID. If no Loopback interfaces are configured, the highest IP address of any interface is used as the router ID.

To view the status of BGP neighbors, use the **show ip bgp neighbors** command in EXEC Privilege mode as shown in the example below. For BGP neighbor configuration information, use the **show running-config bgp** command in EXEC Privilege mode as shown in the second example. Note that the **showconfig** command in CONFIGURATION ROUTER BGP mode gives the same information as the **show running-config bgp**.

The following example displays two neighbors: one is an external and the second one is an internal BGP neighbor. The first line of the output for each neighbor displays the AS number and states whether the link is an external or internal.

The third line of the **show ip bgp neighbors** output contains the BGP State. If anything other than ESTABLISHED is listed, the neighbor is not exchanging information and routes. For more details on using the **show ip bgp neighbors** command, refer to the *FTOS Command Line Interface Reference*.

Example: show ip bgp neighbors

```
FTOS#show ip bgp neighbors
```

```
BGP neighbor is 10.114.8.60, remote AS 18508, external link
  BGP version 4, remote router ID 10.20.20.20
  BGP state ESTABLISHED, in this state for 00:01:58
  Last read 00:00:14, hold time is 90, keepalive interval is 30 seconds
  Received 18552 messages, 0 notifications, 0 in queue
  Sent 11568 messages, 0 notifications, 0 in queue
  Received 18549 updates, Sent 11562 updates
  Minimum time between advertisement runs is 30 seconds
```

```
For address family: IPv4 Unicast
  BGP table version 216613, neighbor version 201190
  130195 accepted prefixes consume 520780 bytes
  Prefix advertised 49304, rejected 0, withdrawn 36143
```

```
Connections established 1; dropped 0
  Last reset never
Local host: 10.114.8.39, Local port: 1037
Foreign host: 10.114.8.60, Foreign port: 179
```

```
BGP neighbor is 10.1.1.1, remote AS 65535, internal link
  Administratively shut down
  BGP version 4, remote router ID 10.0.0.0
  BGP state IDLE, in this state for 17:12:40
  Last read 17:12:40, hold time is 180, keepalive interval is 60 seconds
  Received 0 messages, 0 notifications, 0 in queue
  Sent 0 messages, 0 notifications, 0 in queue
  Received 0 updates, Sent 0 updates
  Minimum time between advertisement runs is 5 seconds
```

```
For address family: IPv4 Unicast
  BGP table version 0, neighbor version 0
  0 accepted prefixes consume 0 bytes
  Prefix advertised 0, rejected 0, withdrawn 0
```

```
Connections established 0; dropped 0
```

```
Last reset never
No active TCP connection
FTOS#
```

Example: show running-config bgp

```
R2#show running-config bgp
!
router bgp 65123
  bgp router-id 192.168.10.2
  network 10.10.21.0/24
  network 10.10.32.0/24
  network 100.10.92.0/24
  network 192.168.10.0/24
  bgp four-octet-as-support
  neighbor 10.10.21.1 remote-as 65123
  neighbor 10.10.21.1 filter-list ISPlin
  neighbor 10.10.21.1 no shutdown
  neighbor 10.10.32.3 remote-as 65123
  neighbor 10.10.32.3 no shutdown
  neighbor 100.10.92.9 remote-as 65192
  neighbor 100.10.92.9 no shutdown
  neighbor 192.168.10.1 remote-as 65123
  neighbor 192.168.10.1 update-source Loopback 0
  neighbor 192.168.10.1 no shutdown
  neighbor 192.168.12.2 remote-as 65123
  neighbor 192.168.12.2 update-source Loopback 0
  neighbor 192.168.12.2 no shutdown
R2#
```

Configure AS4 Number Representations

Enable one type of AS Number Representation: ASPLAIN, ASDOT+, or ASDOT.

- ASPLAIN is the method FTOS has used for all previous FTOS versions. It remains the default method with FTOS 8.2.1.0 and later. With the ASPLAIN notation, a 32 bit binary AS number is translated into a decimal value.
- ASDOT+ representation splits the full binary 4-byte AS number into two words of 16 bits separated by a decimal point (.): <high-order 16 bit value>.<low-order 16 bit value>.
- ASDOT representation combines the ASPLAIN and ASDOT+ representations. AS Numbers less than 65536 appear in integer format (asplain); AS Numbers equal to or greater than 65536 appear using the decimal method (asdot+). For example, the AS Number 65526 appears as 65526, and the AS Number 65546 appears as 1.10.



Note: The ASDOT and ASDOT+ representations are supported only in conjunction with the [4-Byte AS Numbers](#) feature. If 4-Byte AS Numbers are not implemented, only ASPLAIN representation is supported.

Only one form of AS Number Representation is supported at a time. You cannot combine the types of representations within an AS.

| Task | Command Syntax | Command Mode |
|--|--|-------------------|
| Enable ASPLAIN AS Number representation. | bgp asnotation asplain | CONFIG-ROUTER-BGP |
| |  Note: ASPLAIN is the default method FTOS uses and does not appear in the configuration display. | |
| Enable ASDOT AS Number representation. | bgp asnotation asdot | CONFIG-ROUTER-BGP |
| Enable ASDOT+ AS Number representation. | bgp asnotation asdot+ | CONFIG-ROUTER-BGP |

bgp asnotation asplain

```
FTOS(conf-router_bgp)#bgp asnotation asplain
FTOS(conf-router_bgp)#sho conf
!
router bgp 100
  bgp four-octet-as-support
  neighbor 172.30.1.250 remote-as 18508
  neighbor 172.30.1.250 local-as 65057
  neighbor 172.30.1.250 route-map rmap1 in
  neighbor 172.30.1.250 password 7 5ab3eb9a15ed02ff4f0dfd4500d6017873cfd9a267c04957
  neighbor 172.30.1.250 no shutdown
5332332 9911991 65057 18508 12182 7018 46164 i
```

bgp asnotation asdot

```
FTOS(conf-router_bgp)#bgp asnotation asdot
FTOS(conf-router_bgp)#sho conf
!
router bgp 100
  bgp asnotation asdot
  bgp four-octet-as-support
  neighbor 172.30.1.250 remote-as 18508
  neighbor 172.30.1.250 local-as 65057
  neighbor 172.30.1.250 route-map rmap1 in
  neighbor 172.30.1.250 password 7 5ab3eb9a15ed02ff4f0dfd4500d6017873cfd9a267c04957
  neighbor 172.30.1.250 no shutdown
5332332 9911991 65057 18508 12182 7018 46164 i
```

bgp asnotation asdot+

```
FTOS(conf-router_bgp)#bgp asnotation asdot+
FTOS(conf-router_bgp)#sho conf
!
router bgp 100
  bgp asnotation asdot+
  bgp four-octet-as-support
  neighbor 172.30.1.250 remote-as 18508
  neighbor 172.30.1.250 local-as 65057
  neighbor 172.30.1.250 route-map rmap1 in
```

```
neighbor 172.30.1.250 password 7 5ab3eb9a15ed02ff4f0dfd4500d6017873cfd9a267c04957
neighbor 172.30.1.250 no shutdown
5332332 9911991 65057 18508 12182 7018 46164 i
```

Configure Peer Groups

To configure multiple BGP neighbors at one time, create and populate a BGP peer group. Another advantage of peer groups is that members of a peer groups inherit the configuration properties of the group and share same update policy.

A *maximum* of 256 Peer Groups are allowed on the system.

You create a peer group by assigning it a name, then adding members to the peer group. Once a peer group is created, you can configure route policies for it. Refer to [Filter BGP routes](#) for information on configuring route policies for a peer group.



Note: [Sample Configurations](#) for enabling Peer Groups are found at the end of this chapter.

Use these commands in the following sequence starting in the CONFIGURATION ROUTER BGP mode to create a peer group

| Step | Command Syntax | Command Mode | Purpose |
|------|--|-------------------|---|
| 1 | neighbor <i>peer-group-name</i> peer-group | CONFIG-ROUTER-BGP | Create a peer group by assigning a name to it. |
| 2 | neighbor <i>peer-group-name</i> no shutdown | CONFIG-ROUTER-BGP | Enable the peer group. By default, all peer groups are disabled |
| 3 | neighbor <i>ip-address</i> remote-as <i>as-number</i> | CONFIG-ROUTER-BGP | Create a BGP neighbor. |
| 4 | neighbor <i>ip-address</i> no shutdown | CONFIG-ROUTER-BGP | Enable the neighbor. |
| 5 | neighbor <i>ip-address</i> peer-group <i>peer-group-name</i> | CONFIG-ROUTER-BGP | Add an enabled neighbor to the peer group. |
| 6 | neighbor { <i>ip-address</i> <i>peer-group name</i> } remote-as <i>as-number</i> | CONFIG-ROUTER-BGP | Add a neighbor as a remote AS. Formats: IP Address A.B.C.D Peer-Group Name 16 characters AS-number: 0-65535 (2-Byte) or 1-4294967295 0.1- 65535.65535 (4-Byte) or 0.1-65535.65535 (Dotted format) |

| Step | Command Syntax | Command Mode | Purpose |
|------|----------------|--------------|--|
| | | | To add an external BGP (EBGP) neighbor, configure the <i>as-number</i> parameter with a number <i>different</i> from the BGP <i>as-number</i> configured in the router bgp as-number command. |
| | | | To add an internal BGP (IBGP) neighbor, configure the <i>as-number</i> parameter with the <i>same</i> BGP <i>as-number</i> configured in the router bgp as-number command. |

After you create a peer group, you can use any of the commands beginning with the keyword **neighbor** to configure that peer group.

When you add a peer to a peer group, it inherits all the peer group's configured parameters.

A neighbor *cannot* become part of a peer group if it has any of the following commands are configured:

- neighbor advertisement-interval
- neighbor distribute-list out
- neighbor filter-list out
- neighbor next-hop-self
- neighbor route-map out
- neighbor route-reflector-client
- neighbor send-community

A neighbor may keep its configuration after it was added to a peer group if the neighbor's configuration is more specific than the peer group's, and the neighbor's configuration does not affect outgoing updates.



Note: When you configure a new set of BGP policies for a peer group, **always** reset the peer group by entering the **clear ip bgp peer-group peer-group-name** command in EXEC Privilege mode.

Use the **show config** command in the CONFIGURATION ROUTER BGP mode to view the configuration. When you create a peer group, it is disabled (**shutdown**). The following example shows the creation of a peer group (zanzibar).

```
FTOS(conf-router_bgp)#neighbor zanzibar peer-group
FTOS(conf-router_bgp)#show conf
!
router bgp 45
  bgp fast-external-fallover
  bgp log-neighbor-changes
  neighbor zanzibar peer-group
  neighbor zanzibar shutdown
  neighbor 10.1.1.1 remote-as 65535
  neighbor 10.1.1.1 shutdown
  neighbor 10.14.8.60 remote-as 18505
  neighbor 10.14.8.60 no shutdown
FTOS(conf-router_bgp)#
```

Use the **neighbor peer-group-name no shutdown** command in the CONFIGURATION ROUTER BGP mode to enable a peer group.

```
FTOS(conf-router_bgp)#neighbor zanzibar no shutdown
FTOS(conf-router_bgp)#show config
!
router bgp 45
  bgp fast-external-fallover
  bgp log-neighbor-changes
  neighbor zanzibar peer-group
  neighbor zanzibar no shutdown
  neighbor 10.1.1.1 remote-as 65535
  neighbor 10.1.1.1 shutdown
  neighbor 10.14.8.60 remote-as 18505
  neighbor 10.14.8.60 no shutdown
FTOS(conf-router_bgp)#
```

To disable a peer group, use the **neighbor peer-group-name shutdown** command in the CONFIGURATION ROUTER BGP mode. The configuration of the peer group is maintained, but it is not applied to the peer group members. When you disable a peer group, all the peers within the peer group that are in ESTABLISHED state are moved to IDLE state.

Use the **show ip bgp peer-group** command in EXEC Privilege mode as shown in the following example to view the status of peer groups.

```
FTOS>show ip bgp peer-group
```

```
Peer-group zanzibar, remote AS 65535
BGP version 4
Minimum time between advertisement runs is 5 seconds
```

```
For address family: IPv4 Unicast
BGP neighbor is zanzibar, peer-group internal,
Number of peers in this group 26
Peer-group members (* - outbound optimized):
 10.68.160.1
 10.68.161.1
 10.68.162.1
 10.68.163.1
 10.68.164.1
 10.68.165.1
 10.68.166.1
 10.68.167.1
 10.68.168.1
 10.68.169.1
 10.68.170.1
 10.68.171.1
 10.68.172.1
 10.68.173.1
 10.68.174.1
 10.68.175.1
 10.68.176.1
 10.68.177.1
 10.68.178.1
 10.68.179.1
 10.68.180.1
```

```

10.68.181.1
10.68.182.1
10.68.183.1
10.68.184.1
10.68.185.1
FTOS>

```

BGP fast fall-over

By default, a BGP session is governed by the hold time. BGP routers typically carry large routing tables, so frequent session resets are not desirable. The BGP fast fall-over feature reduces the convergence time while maintaining stability. The connection to a BGP peer is immediately reset if a link to a directly connected external peer fails.

When fall-over is enabled, BGP tracks IP reachability to the peer remote address and the peer local address. Whenever either address becomes unreachable (for example, no active route exists in the routing table for peer IPv6 destinations/local address), BGP brings down the session with the peer.

The BGP fast fall-over feature is configured on a per-neighbor or peer-group basis and is disabled by default.

| Command Syntax | Command Mode | Purpose |
|---|-------------------|---------------------------|
| neighbor { <i>ip-address</i> <i>peer-group-name</i> } fall-over | CONFIG-ROUTER-BGP | Enable BGP Fast Fall-Over |

To disable Fast Fall-Over, use the **[no] neighbor [neighbor | peer-group] fall-over** command in CONFIGURATION ROUTER BGP mode

Use the **show ip bgp neighbors** command as shown in the example below to verify that fast fall-over is enabled on a particular BGP neighbor. Note that since Fast Fall-Over is disabled by default, it will appear only if it has been enabled.

```

FTOS#sh ip bgp neighbors

BGP neighbor is 100.100.100.100, remote AS 65517, internal link
  Member of peer-group test for session parameters
  BGP version 4, remote router ID 30.30.30.5
  BGP state ESTABLISHED, in this state for 00:19:15
  Last read 00:00:15, last write 00:00:06
  Hold time is 180, keepalive interval is 60 seconds
  Received 52 messages, 0 notifications, 0 in queue
  Sent 45 messages, 5 notifications, 0 in queue
  Received 6 updates, Sent 0 updates
  Route refresh request: received 0, sent 0
  Minimum time between advertisement runs is 5 seconds
  Minimum time before advertisements start is 0 seconds

Capabilities received from neighbor for IPv4 Unicast :
  MULTIPROTO_EXT(1)
  ROUTE_REFRESH(2)
  CISCO_ROUTE_REFRESH(128)

```

```

Capabilities advertised to neighbor for IPv4 Unicast :
  MULTIPROTO_EXT(1)
  ROUTE_REFRESH(2)
  CISCO_ROUTE_REFRESH(128)

```

```

Fall-over enabled

```

```

Update source set to Loopback 0

```

```

Peer active in peer-group outbound optimization

```

```

For address family: IPv4 Unicast
BGP table version 52, neighbor version 52
4 accepted prefixes consume 16 bytes
Prefix advertised 0, denied 0, withdrawn 0

```

```

Connections established 6; dropped 5
Last reset 00:19:37, due to Reset by peer

```

```

Notification History
'Connection Reset' Sent : 5  Recv: 0

```

```

Local host: 200.200.200.200, Local port: 65519
Foreign host: 100.100.100.100, Foreign port: 179

```

```

FTOS#

```

Use the **show ip bgp peer-group** command to verify that fast fall-over is enabled on a peer-group.

```

FTOS#sh ip bgp peer-group

```

```

Peer-group test
Fall-over enabled
BGP version 4
Minimum time between advertisement runs is 5 seconds

```

```

For address family: IPv4 Unicast
BGP neighbor is test
Number of peers in this group 1
Peer-group members (* - outbound optimized):
  100.100.100.100*

```

```

FTOS#

```

```

router bgp 65517
  neighbor test peer-group
  neighbor test fall-over
  neighbor test no shutdown
  neighbor 100.100.100.100 remote-as 65517
  neighbor 100.100.100.100 fall-over
  neighbor 100.100.100.100 update-source Loopback 0
  neighbor 100.100.100.100 no shutdown
FTOS#

```

Configure passive peering

When you enable a peer-group, the software sends an OPEN message to initiate a TCP connection. If you enable passive peering for the peer group, the software does not send an OPEN message, but it will respond to an OPEN message.

When a BGP neighbor connection with authentication configured is rejected by a passive peer-group, FTOS does not allow another passive peer-group on the same subnet to connect with the BGP neighbor. To work around this, change the BGP configuration or change the order of the peer group configuration.

You can constrain the number of passive sessions accepted by the neighbor. The **limit** keyword allows you to set the total number of sessions the neighbor will accept, between 2 and 265. The default is 256 sessions.

Use these commands in the following sequence, starting in the CONFIGURATION ROUTER BGP mode to configure passive peering.

| Step | Command Syntax | Command Mode | Purpose |
|------|---|-------------------|--|
| 1 | neighbor <i>peer-group-name</i> peer-group passive limit | CONFIG-ROUTER-BGP | Configure a peer group that does not initiate TCP connections with other peers. Enter the limit keyword to restrict the number of sessions accepted. |
| 2 | neighbor <i>peer-group-name</i> subnet <i>subnet-number mask</i> | CONFIG-ROUTER-BGP | Assign a subnet to the peer group. The peer group will respond to OPEN messages sent on this subnet. |
| 3 | neighbor <i>peer-group-name</i> no shutdown | CONFIG-ROUTER-BGP | Enable the peer group. |
| 4 | neighbor <i>peer-group-name</i> remote-as <i>as-number</i> | CONFIG-ROUTER-BGP | Create and specify a remote peer for BGP neighbor. |

Only after the peer group responds to an OPEN message sent on the subnet does its BGP state change to ESTABLISHED. Once the peer group is ESTABLISHED, the peer group is the same as any other peer group.

For more information on peer groups, refer to [Configure Peer Groups](#).

Maintain existing AS numbers during an AS migration

The **local-as** feature smooths out the BGP network migration operation and allows you to maintain existing ASNs during a BGP network migration.

When you complete your migration, be sure to reconfigure your routers with the new information and disable this feature.

| Command Syntax | Command Mode | Purpose |
|--|-----------------------|--|
| neighbor { <i>IP address</i> / <i>peer-group-name</i> local-as <i>as</i> <i>number</i> [no prepend]} | CONFIG-ROUTER- BGP | Allow external routes from this neighbor. Format: IP Address: A.B.C.D Peer Group Name: 16 characters AS-number: 0-65535 (2-Byte) or 1-4294967295 (4-Byte) or 0.1-65535.65535 (Dotted format) No Prepend specifies that local AS values are not prepended to announcements from the neighbor. |

You must [Configure Peer Groups](#) *before* assigning it to an AS.
This feature is not supported on passive peer groups.

Disable this feature, using the **no neighbor local-as** command in CONFIGURATION ROUTER BGP mode.

```
R2(conf-router_bgp)#show conf
!
router bgp 65123
  bgp router-id 192.168.10.2
  network 10.10.21.0/24
  network 10.10.32.0/24
  network 100.10.92.0/24
  network 192.168.10.0/24
  bgp four-octet-as-support
  neighbor 10.10.21.1 remote-as 65123
  neighbor 10.10.21.1 filter-list Laura in
  neighbor 10.10.21.1 no shutdown
  neighbor 10.10.32.3 remote-as 65123
  neighbor 10.10.32.3 no shutdown
  neighbor 100.10.92.9 remote-as 65192
  neighbor 100.10.92.9 local-as 6500
  neighbor 100.10.92.9 no shutdown
  neighbor 192.168.10.1 remote-as 65123
  neighbor 192.168.10.1 update-source Loopback 0
  neighbor 192.168.10.1 no shutdown
  neighbor 192.168.12.2 remote-as 65123
  neighbor 192.168.12.2 update-source Loopback 0
  neighbor 192.168.12.2 no shutdown
R2(conf-router_bgp)#
```

Allow an AS number to appear in its own AS path

This command allows you to set the number of times a particular AS number can occur in the AS path. The **allow-as** feature permits a BGP speaker to allow the ASN to be present for specified number of times in the update received from the peer, even if that ASN matches its own. The AS-PATH loop is detected if the local ASN is present more than the specified number of times in the command.

| Command Syntax | Command Mode | Purpose |
|---|-------------------|--|
| neighbor { <i>IP address</i> / <i>peer-group-name</i> } allow-as-in <i>number</i> | CONFIG-ROUTER-BGP | Allow this neighbor ID to use the AS path the specified number of times. Format: IP Address: A.B.C.D Peer Group Name: 16 characters Number: 1-10 |

You must [Configure Peer Groups](#) before assigning it to an AS.

To disable this feature, use the **no neighbor allow-as in** *number* command in the CONFIGURATION ROUTER BGP mode.

```
R2(conf-router_bgp)#show conf
!
router bgp 65123
  bgp router-id 192.168.10.2
  network 10.10.21.0/24
  network 10.10.32.0/24
  network 100.10.92.0/24
  network 192.168.10.0/24
  bgp four-octet-as-support
  neighbor 10.10.21.1 remote-as 65123
  neighbor 10.10.21.1 filter-list Laura in
  neighbor 10.10.21.1 no shutdown
  neighbor 10.10.32.3 remote-as 65123
  neighbor 10.10.32.3 no shutdown
  neighbor 100.10.92.9 remote-as 65192
  neighbor 100.10.92.9 local-as 6500
  neighbor 100.10.92.9 no shutdown
  neighbor 192.168.10.1 remote-as 65123
  neighbor 192.168.10.1 update-source Loopback 0
  neighbor 192.168.10.1 no shutdown
  neighbor 192.168.12.2 remote-as 65123
  neighbor 192.168.12.2 allow-as-in 9
  neighbor 192.168.12.2 update-source Loopback 0
  neighbor 192.168.12.2 no shutdown
R2(conf-router_bgp)#R2(conf-router_bgp)#
```

Enable graceful restart

Use this feature to lessen the negative effects of a BGP restart. FTOS advertises support for this feature to BGP neighbors through a capability advertisement. You can enable graceful restart by router and/or by peer or peer group.



Note: By default, BGP graceful restart is disabled.

The default role for BGP on is as a receiving or restarting peer. If you enable BGP, when a peer that supports graceful restart resumes operating, FTOS performs the following tasks:

- Continues saving routes received from the peer if the peer advertised it had graceful restart capability. Continues forwarding traffic to the peer.
- Flags routes from the peer as Stale and sets a timer to delete them if the peer does not perform a graceful restart.
- Deletes all routes from the peer if forwarding state information is not saved.
- Speeds convergence by advertising a special update packet known as an end-of-RIB marker. This marker indicates the peer has been updated with all routes in the local RIB.

If you configure your system to do so, FTOS can perform the following actions during a hot failover:

- Save all FIB and CAM entries on the line card and continue forwarding traffic while the secondary RPM is coming online.
- Advertise to all BGP neighbors and peer-groups that the forwarding state of all routes has been saved. This prompts all peers to continue saving the routes they receive from your E-Series and to continue forwarding traffic.
- Bring the secondary RPM online as the primary and re-open sessions with all peers operating in “no shutdown” mode.
- Defer best path selection for a certain amount of time. This helps optimize path selection and results in fewer updates being sent out.

Enable graceful restart using the **configure router bgp graceful-restart** command. The table below shows the command and its available options:

| Command Syntax | Command Mode | Usage |
|---|-------------------|---|
| bgp graceful-restart | CONFIG-ROUTER-BGP | Enable graceful restart for the BGP node. |
| bgp graceful-restart [restart-time time-in-seconds] | CONFIG-ROUTER-BGP | Set maximum restart time for all peers. Default is 120 seconds. |
| bgp graceful-restart [stale-path-time time-in-seconds] | CONFIG-ROUTER-BGP | Set maximum time to retain the restarting peer’s stale paths. Default is 360 seconds. |
| bgp graceful-restart [role receiver-only] | CONFIG-ROUTER-BGP | Local router supports graceful restart as a receiver only. |

BGP graceful restart is active only when the neighbor becomes established. Otherwise, it is disabled. Graceful-restart applies to all neighbors with established adjacency.

With the graceful restart feature, FTOS enables the receiving/restarting mode by default. In receiver-only mode, graceful restart saves the advertised routes of peers that support this capability when they restart. However, the E-Series does not advertise that it saves these forwarding states when it restarts. This option provides support for remote peers for their graceful restart without supporting the feature itself.

You can implement BGP graceful restart either by neighbor or by BGP peer-group. For more information, please refer to the following table or the *FTOS Command Line Interface Reference*.

| Command Syntax | Command Mode | Purpose |
|--|-------------------|---|
| neighbor { <i>ip-address</i> <i>peer-group-name</i> } graceful-restart | CONFIG-ROUTER-BGP | Add graceful restart to a BGP neighbor or peer-group. |
| neighbor { <i>ip-address</i> <i>peer-group-name</i> } graceful-restart [restart-time <i>time-in-seconds</i>] | CONFIG-ROUTER-BGP | Set maximum restart time for the neighbor or peer-group. Default is 120 seconds. |
| neighbor { <i>ip-address</i> <i>peer-group-name</i> } graceful-restart [role receiver-only] | CONFIG-ROUTER-BGP | Local router supports graceful restart for this neighbor or peer-group as a receiver only. |
| neighbor { <i>ip-address</i> <i>peer-group-name</i> } graceful-restart [stale-path-time <i>time-in-seconds</i>] | CONFIG-ROUTER-BGP | Set maximum time to retain the restarting neighbor's or peer-group's stale paths. Default is 360 seconds. |

Filter on an AS-Path attribute

The BGP attribute, AS_PATH, can be used to manipulate routing policies. The AS_PATH attribute contains a sequence of AS numbers representing the route's path. As the route traverses an Autonomous System, the AS number is prepended to the route. You can manipulate routes based on their AS_PATH to affect interdomain routing. By identifying certain AS numbers in the AS_PATH, you can permit or deny routes based on the number in its AS_PATH.

To view all BGP path attributes in the BGP database, use the **show ip bgp paths** command in EXEC Privilege mode as shown in the example below.

```
FTOS#show ip bgp paths
Total 30655 Paths
Address          Hash Refcount Metric Path
0x4014154        0         3      18508 701 3549 19421 i
0x4013914        0         3      18508 701 7018 14990 i
0x5166d6c        0         3      18508 209 4637 1221 9249 9249 i
0x5e62df4        0         2      18508 701 17302 i
0x3a1814c        0        26      18508 209 22291 i
0x567ea9c        0        75      18508 209 3356 2529 i
0x6cc1294        0         2      18508 209 1239 19265 i
0x6cc18d4        0         1      18508 701 2914 4713 17935 i
0x5982e44        0        162      18508 209 i
0x67d4a14        0         2      18508 701 19878 ?
0x559972c        0        31      18508 209 18756 i
```

```

0x59cd3b4      0      2      18508 209 7018 15227 i
0x7128114      0     10     18508 209 3356 13845 i
0x536a914      0      3     18508 209 701 6347 7781 i
0x2ffe884      0      1     18508 701 3561 9116 21350 i
0x2ff7284      0     99     18508 701 1239 577 855 ?
0x2ff7ec4      0      4     18508 209 3561 4755 17426 i
0x2ff8544      0      3     18508 701 5743 2648 i
0x736c144      0      1     18508 701 209 568 721 1494 i
0x3b8d224      0     10     18508 209 701 2019 i
0x5eb1e44      0      1     18508 701 8584 16158 i
0x5cd891c      0      9     18508 209 6453 4759 i
--More--

```

AS-PATH ACLs use regular expressions to search AS_PATH values. AS-PATH ACLs have an “implicit deny.” This means that routes that do not meet a deny or match filter are dropped.

Use these commands in the following sequence, starting in the CONFIGURATION mode to configure an AS-PATH ACL to filter a specific AS_PATH value.

| Step | Command Syntax | Command Mode | Purpose |
|------|---|-------------------|--|
| 1 | ip as-path access-list <i>as-path-name</i> | CONFIGURATION | Assign a name to a AS-PATH ACL and enter AS-PATH ACL mode. |
| 2 | {deny permit} filter <i>parameter</i> | CONFIG-AS-PATH | Enter the parameter to match BGP AS-PATH for filtering. This is the filter that will be used to match the AS-path. The entries can be any format, letters, numbers, or regular expressions. This command can be entered multiple times if multiple filters are desired. Refer to Table 9-4, "Regular Expressions," in Border Gateway Protocol IPv4 (BGPv4) for accepted expressions. |
| 3 | exit | AS-PATH ACL | Return to CONFIGURATION mode |
| 4 | router bgp <i>as-number</i> | CONFIGURATION | Enter ROUTER BGP mode. |
| 5 | neighbor <i>{ip-address peer-group-name}</i> filter-list <i>as-path-name</i> {in out} | CONFIG-ROUTER-BGP | Use a configured AS-PATH ACL for route filtering and manipulation. If you assign an non-existent or empty AS-PATH ACL, the software allows all routes. |

Regular Expressions as filters

Regular expressions are used to filter AS paths or community lists. A regular expression is a special character used to define a pattern that is then compared with an input string.

For an AS-path access list as shown in the commands above, if the AS path matches the regular expression in the access list, then the route matches the access list.

The example below applies access list Eagle to routes inbound from BGP peer 10.5.5.2. Access list Eagle uses a regular expression to deny routes originating in AS 32.

```

FTOS(config)#router bgp 99
FTOS(conf-router_bgp)#neigh AAA peer-group
FTOS(conf-router_bgp)#neigh AAA no shut
FTOS(conf-router_bgp)#show conf
!
router bgp 99
  neighbor AAA peer-group
  neighbor AAA no shutdown
  neighbor 10.155.15.2 remote-as 32
  neighbor 10.155.15.2 shutdown
FTOS(conf-router_bgp)#neigh 10.155.15.2 filter-list 1 in
FTOS(conf-router_bgp)#ex

FTOS(conf)#ip as-path access-list Eagle
FTOS(config-as-path)#deny 32$
FTOS(config-as-path)#ex
FTOS(conf)#router bgp 99
FTOS(conf-router_bgp)#neighbor AAA filter-list Eagle in
FTOS(conf-router_bgp)#show conf
!
router bgp 99
  neighbor AAA peer-group
  neighbor AAA filter-list Eaglein
  neighbor AAA no shutdown
  neighbor 10.155.15.2 remote-as 32
  neighbor 10.155.15.2 filter-list 1 in
  neighbor 10.155.15.2 shutdown
FTOS(conf-router_bgp)#ex
FTOS(conf)#ex

FTOS#show ip as-path-access-lists
ip as-path access-list Eagle
  deny 32$
FTOS#

```

Table 9-4, "Regular Expressions," in Border Gateway Protocol IPv4 (BGPv4) lists the Regular Expressions accepted in FTOS.

Table 9-4. Regular Expressions

| Regular Expression | Definition |
|--------------------|--|
| ^ (caret) | Matches the beginning of the input string. Alternatively, when used as the first character within brackets [^] matches any number except the ones specified within the brackets. |
| \$ (dollar) | Matches the end of the input string. |
| . (period) | Matches any single character, including white space. |
| * (asterisk) | Matches 0 or more sequences of the immediately previous character or pattern. |
| + (plus) | Matches 1 or more sequences of the immediately previous character or pattern. |
| ? (question) | Matches 0 or 1 sequence of the immediately previous character or pattern. |

Table 9-4. Regular Expressions

| Regular Expression | Definition |
|--------------------|---|
| () (parenthesis) | Specifies patterns for multiple use when followed by one of the multiplier metacharacters: asterisk *, plus sign +, or question mark ? |
| [] (brackets) | Matches any enclosed character; specifies a range of single characters |
| - (hyphen) | Used within brackets to specify a range of AS or community numbers. |
| _ (underscore) | Matches a ^, a \$, a comma, a space, a {, or a }. Placed on either side of a string to specify a literal and disallow substring matching. Numerals enclosed by underscores can be preceded or followed by any of the characters listed above. |
| (pipe) | Matches characters on either side of the metacharacter; logical OR. |

As seen in the example in [Regular Expressions as filters](#), the expressions are displayed when using the **show** commands. Use the **show config** command in the CONFIGURATION AS-PATH ACL mode and the **show ip as-path-access-list** command in EXEC Privilege mode to view the AS-PATH ACL configuration.

For more information on this command and route filtering, refer to [Filter BGP routes](#).

Redistribute routes

In addition to filtering routes, you can add routes from other routing instances or protocols to the BGP process. With the **redistribute** command syntax, you can include ISIS, OSPF, static, or directly connected routes in the BGP process.

Use any of the following commands in ROUTER BGP mode to add routes from other routing instances or protocols.

| Command Syntax | Command Mode | Purpose |
|---|---|---|
| redistribute { connected static } [route-map <i>map-name</i>] | ROUTER BGP or CONF-ROUTER_BGPv6_ AF | Include, directly connected or user-configured (static) routes in BGP. Configure the following parameters: <ul style="list-style-type: none"> <i>map-name</i>: name of a configured route map. |
| redistribute isis [level-1 level-1-2 level-2] [metric <i>value</i>] [route-map <i>map-name</i>] | ROUTER BGP or CONF-ROUTER_BGPv6_ AF | Include specific ISIS routes in BGP. Configure the following parameters: <ul style="list-style-type: none"> level-1, level-1-2, or level-2: Assign all redistributed routes to a level. Default is level-2. <i>metric</i> range: 0 to 16777215. Default is 0. <i>map-name</i>: name of a configured route map. |

| Command Syntax | Command Mode | Purpose |
|---|---|--|
| redistribute ospf <i>process-id</i> [match external {1 2} match internal] [metric-type {external internal}] [route-map <i>map-name</i>] | ROUTER BGP or CONF-ROUTER_BGPv6_ AF | Include specific OSPF routes in IS-IS. Configure the following parameters: <ul style="list-style-type: none"> <i>process-id</i> range: 1 to 65535 match external range: 1 or 2 match internal metric-type: external or internal. <i>map-name</i>: name of a configured route map. |

Enable additional paths

By default, the add-path feature is disabled.

Use the following command in the CONFIGURATION ROUTER BGP mode to allow multiple paths sent to peers.



Note: In some cases, while receiving 1K same routes from more than 64 iBGP neighbors, BGP sessions holdtime of 10 seconds may flap. The BGP add-path does not update packets for advertisement and cannot scale to higher numbers. Either reduce the number of routes added or increase the holddown timer value.

| Step | Command Syntax | Command Mode | Purpose |
|------|---|-------------------|---|
| 1 | bgp add-path [send receive both] <i>count</i> | CONFIG-ROUTER-BGP | Allow the advertisement of multiple paths for the same address prefix without the new paths replacing any previous ones. Range: 2-64 |
| 2 | neighbor add-path | CONFIG-ROUTER-BGP | Allow the specified neighbor/peer group to send/receive multiple path advertisements. |
| 3 | max-path <i>number</i> | CONFIG-ROUTER-BGP | Configure the maximum number of parallel routes (multipath support) BGP supports. Range: 2-64 |

Configure IP community lists

Within FTOS, you have multiple methods of manipulating routing attributes. One attribute you can manipulate is the COMMUNITY attribute. This attribute is an optional attribute that is defined for a group of destinations. In FTOS, you can assign a COMMUNITY attribute to BGP routers by using an IP Community list. After you create an IP Community list, you can apply routing decisions to all routers meeting the criteria in the IP Community list.

IETF RFC 1997 defines the COMMUNITY attribute and the pre-defined communities of INTERNET, NO_EXPORT_SUBCONFED, NO_ADVERTISE, and NO_EXPORT. All BGP routes belong to the INTERNET community. In the RFC, the other communities are defined as follows:

- All routes with the NO_EXPORT_SUBCONFED (0xFFFFFFFF03) community attribute are not sent to CONFED-EBGP or EBGP peers, but are sent to IBGP peers within CONFED-SUB-AS
- All routes with the NO_ADVERTISE (0xFFFFFFFF02) community attribute must not be advertised
- All routes with the NO_EXPORT (0xFFFFFFFF01) community attribute must not be advertised outside a BGP confederation boundary, but are sent to CONFED-EBGP and IBGP peers

FTOS also supports BGP Extended Communities as described in RFC 4360—BGP Extended Communities Attribute.

Use these commands in the following sequence, starting in the CONFIGURATION mode to configure an IP community list.

| Step | Command Syntax | Command Mode | Purpose |
|------|--|-----------------------|--|
| 1 | ip community-list <i>community-list-name</i> | CONFIGURATION | Create a Community list and enter the COMMUNITY-LIST mode. |
| 2 | { deny permit } { <i>community-number</i> local-AS no-advertise no-export quote-regexp <i>regular-expression-list</i> regexp <i>regular-expression</i> } | CONFIG-COMMUNITY-LIST | Configure a Community list by denying or permitting specific community numbers or types of community <ul style="list-style-type: none"> • <i>community-number</i>: use AA:NN format where AA is the AS number (2 or 4 Bytes) and NN is a value specific to that autonomous system. • local-AS: routes with the COMMUNITY attribute of NO_EXPORT_SUBCONFED. • no-advertise: routes with the COMMUNITY attribute of NO_ADVERTISE. • no-export: routes with the COMMUNITY attribute of NO_EXPORT. • quote-regexp: followed by any number of regular expressions. The software applies all regular expressions in the list. • regexp: followed by a regular expression. |

Use these commands in the following sequence, starting in the CONFIGURATION mode to configure an IP extended community list.

| Step | Command Syntax | Command Mode | Purpose |
|------|--|---------------|--|
| 1 | ip extcommunity-list <i>extcommunity-list-name</i> | CONFIGURATION | Create a extended community list and enter the EXTCOMMUNITY-LIST mode. |

| Step | Command Syntax | Command Mode | Purpose |
|------|--|---------------------------|--|
| 2 | { permit deny } {{ rt soo } { <i>ASN:NN</i> <i>IPADDR:N</i> } regex <i>REGEX-LINE</i> } | CONFIG-COMMUNITY- LIST | Two types of extended communities are supported. Filter routes based on the type of extended communities they carry using one of the following keywords: <ul style="list-style-type: none"> • rt: Route Target • soo: Route Origin or Site-of-Origin. Support for matching extended communities against regular expression is also supported. Match against a regular expression using the following keyword: <ul style="list-style-type: none"> • regex: regular expression |

To set or modify an extended community attribute, use the **set extcommunity {rt | soo} {ASN:NN | IPADDR:NN}** command.

To view the configuration, use the **show config** command in the CONFIGURATION COMMUNITY-LIST or CONFIGURATION EXTCOMMUNITY LIST mode or the **show ip {community-lists | extcommunity-list} command** in EXEC Privilege mode as shown in the example below.

```
FTOS#show ip community-lists
ip community-list standard 1
deny 701:20
deny 702:20
deny 703:20
deny 704:20
deny 705:20
deny 14551:20
deny 701:112
deny 702:112
deny 703:112
deny 704:112
deny 705:112
deny 14551:112
deny 701:667
deny 702:667
deny 703:667
deny 704:666
deny 705:666
deny 14551:666
FTOS#
```

Use these commands in the following sequence, starting in the CONFIGURATION mode, To use an IP Community list or Extended Community List to filter routes, you must apply a **match community** filter to a route map and then apply that route map to a BGP neighbor or peer group.

| Step | Command Syntax | Command Mode | Purpose |
|------|---|---------------|--|
| 1 | route-map <i>map-name</i> [permit deny] [<i>sequence-number</i>] | CONFIGURATION | Enter the ROUTE-MAP mode and assign a name to a route map. |

| Step | Command Syntax | Command Mode | Purpose |
|------|---|-------------------|---|
| 2 | match { community <i>community-list-name</i> [exact] extcommunity <i>extcommunity-list-name</i> [exact]} | CONFIG-ROUTE-MAP | Configure a match filter for all routes meeting the criteria in the IP Community or Extended Community list. |
| 3 | exit | CONFIG-ROUTE-MAP | Return to the CONFIGURATION mode. |
| 4 | router bgp <i>as-number</i> | CONFIGURATION | Enter the ROUTER BGP mode. AS-number: 0-65535 (2-Byte) or 1-4294967295 (4-Byte) or 0.1-65535.65535 (Dotted format) |
| 5 | neighbor { <i>ip-address</i> <i>peer-group-name</i> } route-map <i>map-name</i> { in out } | CONFIG-ROUTER-BGP | Apply the route map to the neighbor or peer group's incoming or outgoing routes. |

To view the BGP configuration, use the **show config** command in CONFIGURATION ROUTER BGP mode. To view a route map configuration, use the **show route-map** command in EXEC Privilege mode.

To view which BGP routes meet an IP Community or Extended Community list's criteria, use the **show ip bgp {community-list | extcommunity-list} command** in EXEC Privilege mode.

Manipulate the COMMUNITY attribute

In addition to permitting or denying routes based on the values of the COMMUNITY attributes, you can manipulate the COMMUNITY attribute value and send the COMMUNITY attribute with the route information.

By default, FTOS does not send the COMMUNITY attribute.

Use the following command in the CONFIGURATION ROUTER BGP mode to send the COMMUNITY attribute to BGP neighbors.

| Command Syntax | Command Mode | Purpose |
|--|-------------------|---|
| neighbor { <i>ip-address</i> <i>peer-group-name</i> } send-community | CONFIG-ROUTER-BGP | Enable the software to send the router's COMMUNITY attribute to the BGP neighbor or peer group specified. |

To view the BGP configuration, use the **show config** command in the CONFIGURATION ROUTER BGP mode.

If you want to remove or add a specific COMMUNITY number from a BGP path, you must create a route map with one or both of the following statements in the route map. Then apply that route map to a BGP neighbor or peer group. Use these commands in the following sequence, starting in the CONFIGURATION mode:

| Step | Command Syntax | Command Mode | Purpose |
|------|---|-------------------|--|
| 1 | route-map <i>map-name</i> [permit deny] [<i>sequence-number</i>] | CONFIGURATION | Enter the ROUTE-MAP mode and assign a name to a route map. |
| 2 | set comm-list <i>community-list-name</i> delete | CONFIG-ROUTE-MAP | Configure a set filter to delete all COMMUNITY numbers in the IP Community list. |
| | set community { <i>community-number</i> local-as no-advertise no-export none } | CONFIG-ROUTE-MAP | Configure a Community list by denying or permitting specific community numbers or types of community <ul style="list-style-type: none"> • <i>community-number</i>: use AA:NN format where AA is the AS number (2 or 4 Bytes) and NN is a value specific to that autonomous system. • local-AS: routes with the COMMUNITY attribute of NO_EXPORT_SUBCONFED and are not sent to EBGp peers. • no-advertise: routes with the COMMUNITY attribute of NO_ADVERTISE and are not advertised. • no-export: routes with the COMMUNITY attribute of NO_EXPORT. • none: remove the COMMUNITY attribute. • additive: add the communities to already existing communities. |
| 3 | exit | CONFIG-ROUTE-MAP | Return to the CONFIGURATION mode. |
| 4 | router bgp <i>as-number</i> | CONFIGURATION | Enter the ROUTER BGP mode. |
| 5 | neighbor { <i>ip-address</i> <i>peer-group-name</i> } route-map <i>map-name</i> { in out } | CONFIG-ROUTER-BGP | Apply the route map to the neighbor or peer group's incoming or outgoing routes. |

To view the BGP configuration, use the **show config** command in CONFIGURATION ROUTER BGP mode. To view a route map configuration, use the **show route-map** command in EXEC Privilege mode.

Use the **show ip bgp community** command in EXEC Privilege mode as shown in the following example to view BGP routes matching a certain community number or pre-defined BGP community.

```
FTOS>show ip bgp community
BGP table version is 3762622, local router ID is 10.114.8.48
Status codes: s suppressed, d damped, h history, * valid, > best, i - internal
Origin codes: i - IGP, e - EGP, ? - incomplete

   Network          Next Hop          Metric      LocPrf   Weight   Path
* i 3.0.0.0/8       195.171.0.16      100         100     0   209 701 80 i
*>i 4.2.49.12/30    195.171.0.16      100         100     0   209 i
```

```

* i 4.21.132.0/23          195.171.0.16          100          0 209 6461 16422 i
*>i 4.24.118.16/30        195.171.0.16          100          0 209 i
*>i 4.24.145.0/30        195.171.0.16          100          0 209 i
*>i 4.24.187.12/30       195.171.0.16          100          0 209 i
*>i 4.24.202.0/30        195.171.0.16          100          0 209 i
*>i 4.25.88.0/30         195.171.0.16          100          0 209 3561 3908 i
*>i 6.1.0.0/16           195.171.0.16          100          0 209 7170 1455 i
*>i 6.2.0.0/22           195.171.0.16          100          0 209 7170 1455 i
*>i 6.3.0.0/18           195.171.0.16          100          0 209 7170 1455 i
*>i 6.4.0.0/16           195.171.0.16          100          0 209 7170 1455 i
*>i 6.5.0.0/19           195.171.0.16          100          0 209 7170 1455 i
*>i 6.8.0.0/20           195.171.0.16          100          0 209 7170 1455 i
*>i 6.9.0.0/20           195.171.0.16          100          0 209 7170 1455 i
*>i 6.10.0.0/15          195.171.0.16          100          0 209 7170 1455 i
*>i 6.14.0.0/15          205.171.0.16          100          0 209 7170 1455 i
*>i 6.133.0.0/21         205.171.0.16          100          0 209 7170 1455 i
*>i 6.151.0.0/16         205.171.0.16          100          0 209 7170 1455 i
--More--

```

Change MED attribute

By default, FTOS uses the MULTI_EXIT_DISC or MED attribute when comparing EBGP paths from the same AS.

Use any or all of the following commands in the CONFIGURATION ROUTER BGP mode to change how the MED attribute is used.

| Command Syntax | Command Mode | Purpose |
|--|-------------------|---|
| bgp always-compare-med | CONFIG-ROUTER-BGP | Enable MED comparison in the paths from neighbors with different ASs. By default, this comparison is not performed. |
| bgp bestpath med {confed missing-as-best} | CONFIG-ROUTER-BGP | Change the bestpath MED selection to one of the following: confed : Chooses the bestpath MED comparison of paths learned from BGP confederations. missing-as-best : Treat a path missing an MED as the most preferred one |

Use the **show config** command in the CONFIGURATION ROUTER BGP mode to view the nondefault values.

Change LOCAL_PREFERENCE attribute

In FTOS, you can change the value of the LOCAL_PREFERENCE attribute.

Use the following command in the CONFIGURATION ROUTER BGP mode to change the default values of this attribute for all routes received by the router.

| Command Syntax | Command Mode | Purpose |
|--|-------------------|---|
| bgp default local-preference <i>value</i> | CONFIG-ROUTER-BGP | Change the LOCAL_PREF value. <ul style="list-style-type: none"> <i>value</i> range: 0 to 4294967295 Default is 100. |

Use the **show config** command in CONFIGURATION ROUTER BGP mode or the **show running-config bgp** command in EXEC Privilege mode to view BGP configuration.

A more flexible method for manipulating the LOCAL_PREF attribute value is to use a route map.

Use these commands in the following sequence, starting CONFIGURATION mode to change the default value of the LOCAL_PREF attribute for specific routes.

| Step | Command Syntax | Command Mode | Purpose |
|------|--|-------------------|--|
| 1 | route-map <i>map-name</i> [permit deny] [<i>sequence-number</i>] | CONFIGURATION | Enter the ROUTE-MAP mode and assign a name to a route map. |
| 2 | set local-preference <i>value</i> | CONFIG-ROUTE-MAP | Change LOCAL_PREF value for routes meeting the criteria of this route map. |
| 3 | exit | CONFIG-ROUTE-MAP | Return to the CONFIGURATION mode. |
| 4 | router bgp <i>as-number</i> | CONFIGURATION | Enter the ROUTER BGP mode. |
| 5 | neighbor { <i>ip-address</i> <i>peer-group-name</i> } route-map <i>map-name</i> { in out } | CONFIG-ROUTER-BGP | Apply the route map to the neighbor or peer group's incoming or outgoing routes. |

To view the BGP configuration, use the **show config** command in the CONFIGURATION ROUTER BGP mode. To view a route map configuration, use the **show route-map** command in EXEC Privilege mode.

Change NEXT_HOP attribute

You can change how the NEXT_HOP attribute is used.

Use the following command in the CONFIGURATION ROUTER BGP mode to change the how the NEXT_HOP attribute is used.

| Command Syntax | Command Mode | Purpose |
|---|-------------------|--|
| neighbor { <i>ip-address</i> <i>peer-group-name</i> } next-hop-self | CONFIG-ROUTER-BGP | Disable next hop processing and configure the router as the next hop for a BGP neighbor. |

Use the **show config** command in CONFIGURATION ROUTER BGP mode or the **show running-config bgp** command in EXEC Privilege mode to view BGP configuration.

You can also use route maps to change this and other BGP attributes. For example, you can include the following command in a route map to specify the next hop address:

| Command Syntax | Command Mode | Purpose |
|---------------------------------------|------------------|----------------------------|
| set next-hop <i>ip-address</i> | CONFIG-ROUTE-MAP | Sets the next hop address. |

Change WEIGHT attribute

Use the following command in CONFIGURATION ROUTER BGP mode to change the how the WEIGHT attribute is used.

| Command Syntax | Command Mode | Purpose |
|--|-------------------|---|
| neighbor { <i>ip-address</i> <i>peer-group-name</i> } weight <i>weight</i> | CONFIG-ROUTER-BGP | Assign a weight to the neighbor connection. <ul style="list-style-type: none"> <i>weight</i> range: 0 to 65535 Default is 0 |

Use the **show config** command in CONFIGURATION ROUTER BGP mode or the **show running-config bgp** command in EXEC Privilege mode to view BGP configuration.

You can also use route maps to change this and other BGP attributes. For example, you can include the following command in a route map to specify the next hop address:

| Command Syntax | Command Mode | Purpose |
|---------------------------------|------------------|--|
| set weight <i>weight</i> | CONFIG-ROUTE-MAP | Sets weight for the route. <ul style="list-style-type: none"> <i>weight</i> range: 0 to 65535 |

Enable multipath

By default, the software allows one path to a destination. You can enable multipath to allow up to 16 parallel paths to a destination.

Use the following command in the CONFIGURATION ROUTER BGP mode to allow more than one path.

| Command Syntax | Command Mode | Purpose |
|--|-------------------|--|
| maximum-paths { ebgp ibgp } <i>number</i> | CONFIG-ROUTER-BGP | Enable multiple parallel paths. <ul style="list-style-type: none"> <i>number</i> range: 1 to 16 Default is 1 |

The **show ip bgp** *network* command includes multipath information for that network.

Filter BGP routes

Filtering routes allows you to implement BGP policies. You can use either IP prefix lists, route maps, AS-PATH ACLs or IP Community lists (via a route map) to control which routes are accepted and advertised by the BGP neighbor or peer group. Prefix lists filter routes based on route and prefix length, while AS-Path ACLs filter routes based on the Autonomous System number. Route maps can filter and set conditions, change attributes, and assign update policies.

 **Note:** FTOS supports up to 255 characters in a set community statement inside a route map.

 **Note:** With FTOS, you can create inbound and outbound policies. Each of the commands used for filtering, has **in** and **out** parameters that must be applied. In FTOS, the order of preference varies depending on whether the attributes are applied for inbound updates or outbound updates.

For inbound and outbound updates the order of preference is:

- prefix lists (using **neighbor distribute-list** command)
- AS-PATH ACLs (using **neighbor filter-list** command)
- route maps (using **neighbor route-map** command)

Prior to filtering BGP routes, you must create the prefix list, AS-PATH ACL, or route map to be used.

Refer to [Access Control Lists \(ACLs\) in the Access Control Lists \(ACLs\) chapter](#) for configuration information on prefix lists, AS-PATH ACLs, and route maps.

 **Note:** When you configure a new set of BGP policies, always reset the neighbor or peer group by entering the **clear ip bgp** command in EXEC Privilege mode.

Use these commands in the following sequence, starting in the CONFIGURATION mode to filter routes using prefix lists.

| Step | Command Syntax | Command Mode | Purpose |
|------|---|--------------------|--|
| 1 | ip prefix-list <i>prefix-name</i> | CONFIGURATION | Create a prefix list and assign it a name. |
| 2 | seq <i>sequence-number</i> { deny permit } { <i>any</i> <i>ip-prefix</i> [ge le] } | CONFIG-PREFIX LIST | Create multiple prefix list filters with a deny or permit action. ge : Minimum prefix length to be matched le : maximum prefix length to be matched Refer to Access Control Lists (ACLs) for information on configuring prefix lists. |
| 3 | exit | CONFIG-PREFIX LIST | Return to the CONFIGURATION mode. |
| 4 | router bgp <i>as-number</i> | CONFIGURATION | Enter ROUTER BGP mode. |

| Step | Command Syntax | Command Mode | Purpose |
|------|--|-------------------|---|
| 5 | neighbor { <i>ip-address</i> <i>peer-group-name</i> } distribute-list <i>prefix-list-name</i> { in out } | CONFIG-ROUTER-BGP | Filter routes based on the criteria in the configured prefix list. Configure the following parameters: <ul style="list-style-type: none"> <i>ip-address</i> or <i>peer-group-name</i>: enter the neighbor's IP address or the peer group's name. <i>prefix-list-name</i>: enter the name of a configured prefix list. in: apply the prefix list to inbound routes. out: apply the prefix list to outbound routes. |

As a reminder, below are some rules concerning prefix lists:

- If the prefix list contains no filters, all routes are permitted.
- If none of the routes match any of the filters in the prefix list, the route is denied. This action is called an implicit deny. (If you want to forward all routes that do not match the prefix list criteria, you must configure a prefix list filter to permit all routes. For example, you could have the following filter as the last filter in your prefix list **permit 0.0.0.0/0 le 32**).
- Once a route matches a filter, the filter's action is applied. No additional filters are applied to the route.

To view the BGP configuration, use the **show config** command in the ROUTER BGP mode. To view a prefix list configuration, use the **show ip prefix-list detail** or **show ip prefix-list summary** commands in EXEC Privilege mode.

Use these commands in the following sequence, starting in the CONFIGURATION mode to filter routes using a route map.

| Step | Command Syntax | Command Mode | Purpose |
|------|---|------------------|--|
| 1 | route-map <i>map-name</i> [permit deny] [<i>sequence-number</i>] | CONFIGURATION | Create a route map and assign it a name. |
| 2 | { match set } | CONFIG-ROUTE-MAP | Create multiple route map filters with a match or set action. Refer to Access Control Lists (ACLs) for information on configuring route maps. |
| 3 | exit | CONFIG-ROUTE-MAP | Return to the CONFIGURATION mode. |
| 4 | router bgp <i>as-number</i> | CONFIGURATION | Enter ROUTER BGP mode. |

| Step | Command Syntax | Command Mode | Purpose |
|------|--|-------------------|---|
| | neighbor { <i>ip-address</i> <i>peer-group-name</i> } route-map <i>map-name</i> { in out } | CONFIG-ROUTER-BGP | Filter routes based on the criteria in the configured route map. Configure the following parameters: <ul style="list-style-type: none"> • <i>ip-address</i> or <i>peer-group-name</i>: enter the neighbor's IP address or the peer group's name. • <i>map-name</i>: enter the name of a configured route map. • in: apply the route map to inbound routes. • out: apply the route map to outbound routes. |

Use the **show config** command in CONFIGURATION ROUTER BGP mode to view the BGP configuration. Use the **show route-map** command in EXEC Privilege mode to view a route map configuration.

Use these commands in the following sequence, beginning in the CONFIGURATION mode to filter routes based on AS-PATH information.

| Step | Command Syntax | Command Mode | Purpose |
|------|--|-------------------|---|
| 1 | ip as-path access-list <i>as-path-name</i> | CONFIGURATION | Create a AS-PATH ACL and assign it a name. |
| 2 | { deny permit } <i>as-regular-expression</i> | AS-PATH ACL | Create a AS-PATH ACL filter with a deny or permit action. |
| 3 | exit | AS-PATH ACL | Return to the CONFIGURATION mode. |
| 4 | router bgp <i>as-number</i> | CONFIGURATION | Enter ROUTER BGP mode. |
| 5 | neighbor { <i>ip-address</i> <i>peer-group-name</i> } filter-list <i>as-path-name</i> { in out } | CONFIG-ROUTER-BGP | Filter routes based on the criteria in the configured route map. Configure the following parameters: <ul style="list-style-type: none"> • <i>ip-address</i> or <i>peer-group-name</i>: enter the neighbor's IP address or the peer group's name. • <i>as-path-name</i>: enter the name of a configured AS-PATH ACL. • in: apply the AS-PATH ACL map to inbound routes. • out: apply the AS-PATH ACL to outbound routes. |

Use the **show config** command in CONFIGURATION ROUTER BGP mode and **show ip as-path-access-list** command in EXEC Privilege mode to view which commands are configured.

Include this filter **permit .*** in your AS-PATH ACL to forward all routes not meeting the AS-PATH ACL criteria.

Configure BGP route reflectors

BGP route reflectors are intended for Autonomous Systems with a large mesh and they reduce the amount of BGP control traffic. With route reflection configured properly, IBGP routers are not fully meshed within a cluster but all receive routing information.

Configure clusters of routers where one router is a concentration router and others are clients who receive their updates from the concentration router.

Use the following commands in the CONFIGURATION ROUTER BGP mode to configure a route reflector.

| Command Syntax | Command Mode | Purpose |
|---|-------------------|--|
| bgp cluster-id <i>cluster-id</i> | CONFIG-ROUTER-BGP | Assign an ID to a router reflector cluster. You can have multiple clusters in an AS. |
| neighbor { <i>ip-address</i> <i>peer-group-name</i> } route-reflector-client | CONFIG-ROUTER-BGP | Configure the local router as a route reflector and the neighbor or peer group identified is the route reflector client. |

To view a route reflector configuration, use the **show config** command in the CONFIGURATION ROUTER BGP mode or **show running-config bgp** in EXEC Privilege mode.

When you enable a route reflector, FTOS automatically enables route reflection to all clients. To disable route reflection between all clients in this reflector, use the **no bgp client-to-client reflection** command in CONFIGURATION ROUTER BGP mode. All clients should be fully meshed before you disable route reflection.

Aggregate routes

FTOS provides multiple ways to aggregate routes in the BGP routing table. At least one specific route of the aggregate must be in the routing table for the configured aggregate to become active.

Use the following command in the CONFIGURATION ROUTER BGP mode to aggregate routes.

| Command Syntax | Command Mode | Purpose |
|---|-----------------------|--|
| aggregate-address <i>ip-address mask</i> [advertise-map <i>map-name</i>] [as-set] [attribute-map <i>map-name</i>] [summary-only] [suppress-map <i>map-name</i>] | CONFIG-ROUTER- BGP | Assign the IP address and mask of the prefix to be aggregated. Optional parameters are: <ul style="list-style-type: none"> • advertise-map <i>map-name</i>: set filters for advertising an aggregate route • as-set: generate path attribute information and include it in the aggregate. • attribute-map <i>map-name</i>: <i>modify</i> attributes of the aggregate, except for the AS_PATH and NEXT_HOP attributes • summary-only: advertise only the aggregate address. Specific routes will not be advertised • suppress-map <i>map-name</i>: identify which more-specific routes in the aggregate are suppressed |

AS_SET includes AS_PATH and community information from the routes included in the aggregated route.

In the **show ip bgp** command, aggregates contain an ‘a’ in the first column and routes suppressed by the aggregate contain an ‘s’ in the first column.

```

FTOS#show ip bgp
BGP table version is 0, local router ID is 10.101.15.13
Status codes: s suppressed, d damped, h history, * valid, > best
Path source: I - internal, a - aggregate, c - confed-external, r - redistributed, n - network
Origin codes: i - IGP, e - EGP, ? - incomplete

   Network          Next Hop          Metric      LocPrf  Weight Path
*>  7.0.0.0/29      10.114.8.33         0           0 18508 ?
*>  7.0.0.0/30      10.114.8.33         0           0 18508 ?
*>a 9.0.0.0/8        192.0.0.0           32768      18508 701 {7018 2686 3786} ?
*>  9.2.0.0/16      10.114.8.33         0           0 18508 701 i
*>  9.141.128.0/24  10.114.8.33         0           0 18508 701 7018 2686 ?
FTOS#
  
```

Configure BGP confederations

Another way to organize routers within an AS and reduce the mesh for IBGP peers is to configure BGP confederations. As with route reflectors, BGP confederations are recommended only for IBGP peering involving a large number of IBGP peering sessions per router. Basically, when you configure BGP confederations, you break the AS into smaller sub-AS, and to those outside your network, the confederations appear as one AS. Within the confederation sub-AS, the IBGP neighbors are fully meshed and the MED, NEXT_HOP, and LOCAL_PREF attributes are maintained between confederations.

Use the following commands in the CONFIGURATION ROUTER BGP mode to configure BGP confederations.

| Command Syntax | Command Mode | Purpose |
|---|-------------------|---|
| bgp confederation identifier <i>as-number</i> | CONFIG-ROUTER-BGP | Specifies the confederation ID. AS-number: 0-65535 (2-Byte) or 1-4294967295 (4-Byte) |
| bgp confederation peers <i>as-number</i> [... <i>as-number</i>] | CONFIG-ROUTER-BGP | Specifies which confederation sub-AS are peers. AS-number: 0-65535 (2-Byte) or 1-4294967295 (4-Byte) |
| All Confederation routers must be either 4-Byte or 2-Byte. You cannot have a mix of router ASN support, | | |

Use the **show config** command in the CONFIGURATION ROUTER BGP mode to view the configuration.

Enable route flap dampening

When EBGP routes become unavailable, they “flap” and the router issues both WITHDRAWN and UPDATE notices. A flap is when a route

- is withdrawn
- is readvertised after being withdrawn
- has an attribute change

The constant router reaction to the WITHDRAWN and UPDATE notices causes instability in the BGP process. To minimize this instability, you may configure penalties, a numeric value, for routes that flap. When that penalty value reaches a configured limit, the route is not advertised, even if the route is up. In FTOS, that penalty value is 1024. As time passes and the route does not flap, the penalty value decrements or is decayed. However, if the route flaps again, it is assigned another penalty.

The penalty value is cumulative and penalty is added under following cases:

- Withdraw
- Readvertise
- Attribute change

When dampening is applied to a route, its path is described by one of the following terms:

- history entry—an entry that stores information on a downed route
- dampened path—a path that is no longer advertised
- penalized path—a path that is assigned a penalty

The CLI example below shows configuring values to start reusing or restarting a route, as well as their default values.

```

FTOS(conf-router_bgp)#bgp dampening ?
<1-45> Half-life time for the penalty (default = 15)
route-map Route-map to specify criteria for dampening
<cr>
FTOS(conf-router_bgp)#bgp dampening 2 ?
<1-20000> Value to start reusing a route (default = 750)
FTOS(conf-router_bgp)#bgp dampening 2 2000 ?
<1-20000> Value to start suppressing a route (default = 2000)
FTOS(conf-router_bgp)#bgp dampening 2 2000 3000 ?
<1-255> Maximum duration to suppress a stable route (default = 60)
FTOS(conf-router_bgp)#bgp dampening 2 2000 3000 10 ?
route-map Route-map to specify criteria for dampening
<cr>

```

Use the following command in the CONFIGURATION ROUTER BGP mode to configure route flap dampening parameters.

| Command Syntax | Command Mode | Purpose |
|--|-----------------------|---|
| bgp dampening [<i>half-life</i> <i>reuse</i> <i>suppress</i> <i>max-suppress-time</i>] [route-map map-name] | CONFIG-ROUTER-B GP | Enable route dampening. Enter the following optional parameters to configure route dampening parameters: <ul style="list-style-type: none"> • <i>half-life</i> range: 1 to 45. Number of minutes after which the Penalty is decreased. After the router assigns a Penalty of 1024 to a route, the Penalty is decreased by half after the half-life period expires. (Default: 15 minutes) • <i>reuse</i> range: 1 to 20000. This number is compared to the flapping route's Penalty value. If the Penalty value is less than the reuse value, the flapping route is once again advertised (or no longer suppressed). Withdrawn routes are removed from history state. (Default: 750) • <i>suppress</i> range: 1 to 20000. This number is compared to the flapping route's Penalty value. If the Penalty value is greater than the suppress value, the flapping route is no longer advertised (that is, it is suppressed). (Default: 2000.) • <i>max-suppress-time</i> range: 1 to 255. The maximum number of minutes a route can be suppressed. The default is four times the half-life value. (Default: 60 minutes.) • route-map map-name: name of a configured route map. Only match commands in the configured route map are supported. Use this parameter to apply route dampening to selective routes. |

To view the BGP configuration, use **show config** in the CONFIGURATION ROUTER BGP mode or **show running-config bgp** in EXEC Privilege mode.

To set dampening parameters via a route map, use the following command in CONFIGURATION ROUTE-MAP mode:

| Command Syntax | Command Mode | Purpose |
|--|------------------|--|
| set dampening <i>half-life reuse suppress max-suppress-time</i> | CONFIG-ROUTE-MAP | <p>Enter the following optional parameters to configure route dampening parameters:</p> <ul style="list-style-type: none"> <i>half-life</i> range: 1 to 45. Number of minutes after which the Penalty is decreased. After the router assigns a Penalty of 1024 to a route, the Penalty is decreased by half after the half-life period expires. (Default: 15 minutes) <i>reuse</i> range: 1 to 20000. This number is compared to the flapping route's Penalty value. If the Penalty value is less than the reuse value, the flapping route is once again advertised (or no longer suppressed). (Default: 750) <i>suppress</i> range: 1 to 20000. This number is compared to the flapping route's Penalty value. If the Penalty value is greater than the suppress value, the flapping route is no longer advertised (that is, it is suppressed). (Default: 2000.) <i>max-suppress-time</i> range: 1 to 255. The maximum number of minutes a route can be suppressed. The default is four times the half-life value. (Default: 60 minutes.) |

To view a count of dampened routes, history routes and penalized routes when route dampening is enabled, look at the seventh line of the **show ip bgp** summary command output as shown in the following example.

```

FTOS>show ip bgp summary
BGP router identifier 10.114.8.131, local AS number 65515
BGP table version is 855562, main routing table version 780266
122836 network entrie(s) and 221664 paths using 29697640 bytes of memory
34298 BGP path attribute entrie(s) using 1920688 bytes of memory
29577 BGP AS-PATH entrie(s) using 1384403 bytes of memory
184 BGP community entrie(s) using 7616 bytes of memory
Dampening enabled. 0 history paths, 0 dampened paths, 0 penalized paths

Neighbor          AS      MsgRcvd MsgSent   TblVer  InQ   OutQ Up/Down   State/PfxRcd
10.114.8.34       18508   82883   79977    780266  0     2  00:38:51 118904
10.114.8.33       18508  117265   25069    780266  0    20  00:38:50 102759
FTOS>

```

To view which routes are dampened (non-active), use the **show ip bgp dampened-routes** command in EXEC Privilege mode.

Use the following command in EXEC Privilege mode to clear information on route dampening and return suppressed routes to active state.

| Command Syntax | Command Mode | Purpose |
|--|----------------|--|
| clear ip bgp dampening [<i>ip-address mask</i>] | EXEC Privilege | Clear all information or only information on a specific route. |

Use the following command in EXEC and EXEC Privilege mode to view statistics on route flapping.

| Command Syntax | Command Mode | Purpose |
|--|------------------------|--|
| show ip bgp flap-statistics [<i>ip-address</i> [<i>mask</i>]] [filter-list <i>as-path-name</i>] [regex <i>regular-expression</i>] | EXEC EXEC Privilege | View all flap statistics or for specific routes meeting the following criteria: <ul style="list-style-type: none">• <i>ip-address</i> [<i>mask</i>]: enter the IP address and mask• filter-list <i>as-path-name</i>: enter the name of an AS-PATH ACL.• regex <i>regular-expression</i>: enter a regular expression to match on. |

By default, the path selection in FTOS is deterministic, that is, paths are compared irrespective of the order of their arrival. You can change the path selection method to non-deterministic, that is, paths are compared in the order in which they arrived (starting with the most recent). Furthermore, in non-deterministic mode, the software may not compare MED attributes though the paths are from the same AS.

Use the following command in CONFIGURATION ROUTER BGP mode to change the path selection from the default mode (deterministic) to non-deterministic.

| Command Syntax | Command Mode | Purpose |
|----------------------------------|-------------------|---|
| bgp non-deterministic-med | CONFIG-ROUTER-BGP | Change the best path selection method to non-deterministic. |

 **Note:** When you change the best path selection method, path selection for existing paths remains unchanged until you reset it by entering the **clear ip bgp** command in EXEC Privilege mode.

Change BGP timers

Use either or both of the following commands in the CONFIGURATION ROUTER BGP mode to configure BGP timers.

| Command Syntax | Command Mode | Purpose |
|--|-------------------|---|
| neighbors { <i>ip-address</i> <i>peer-group-name</i> } timers <i>keepalive</i> <i>holdtime</i> | CONFIG-ROUTER-BGP | Configure timer values for a BGP neighbor or peer group. <ul style="list-style-type: none">• <i>keepalive</i> range: 1 to 65535. Time interval, in seconds, between keepalive messages sent to the neighbor routers. (Default: 60 seconds)• <i>holdtime</i> range: 3 to 65536. Time interval, in seconds, between the last keepalive message and declaring the router dead. (Default: 180 seconds) |

| Command Syntax | Command Mode | Purpose |
|---|-------------------|---|
| timers bgp <i>keepalive holdtime</i> | CONFIG-ROUTER-BGP | Configure timer values for all neighbors. <ul style="list-style-type: none"> <i>keepalive</i> range: 1 to 65535. Time interval, in seconds, between keepalive messages sent to the neighbor routers. (Default: 60 seconds) <i>holdtime</i> range: 3 to 65536. Time interval, in seconds, between the last keepalive message and declaring the router dead. (Default: 180 seconds) |

Use the **show config** command in CONFIGURATION ROUTER BGP mode or the **show running-config bgp** command in EXEC Privilege mode to view non-default values.

Timer values configured with the **neighbor timers** command override the timer values configured with the **timers bgp** command.

When two neighbors, configured with different *keepalive* and *holdtime* values, negotiate for new values, the resulting values will be as follows:

- the lower of the *holdtime* values is the new *holdtime* value, and
- whichever is the lower value; one-third of the new *holdtime* value, or the configured *keepalive* value is the new *keepalive* value.

BGP neighbor soft-reconfiguration

Changing routing policies typically requires a reset of BGP sessions (the TCP connection) for the policies to take effect. Such resets cause undue interruption to traffic due to hard reset of the BGP cache and the time it takes to re-establish the session. BGP soft reconfig allows for policies to be applied to a session without clearing the BGP Session. Soft-reconfig can be done on a per-neighbor basis and can either be inbound or outbound.

BGP Soft Reconfiguration clears the policies without resetting the TCP connection.

Use the **clear ip bgp** command in EXEC Privilege mode at the system prompt to reset a BGP connection using BGP soft reconfiguration.

| Command Syntax | Command Mode | Purpose |
|---|-------------------|--|
| clear ip bgp {* neighbor-address AS Numbers ipv4 peer-group-name} [soft [in out]] | EXEC Privilege | Clear all information or only specific details. *: Clear all peers <i>neighbor-address</i> : Clear the neighbor with this IP address <i>AS Numbers</i> : Peers' AS numbers to be cleared <i>ipv4</i> : Clear information for IPv4 Address family <i>peer-group-name</i> : Clear all members of the specified peer group |
| neighbor {ip-address peer-group-name} soft-reconfiguration inbound | CONFIG-ROUTER-BGP | Enable soft-reconfiguration for the BGP neighbor specified. BGP stores all the updates received by the neighbor but does not reset the peer-session. |

| Command Syntax | Command Mode | Purpose |
|----------------|--------------|---|
| | | Entering this command starts the storage of updates, which is required to do inbound soft reconfiguration. Outbound BGP soft reconfiguration does not require inbound soft reconfiguration to be enabled. |

When soft-reconfiguration is enabled for a neighbor and the **clear ip bgp soft in** command is executed, the update database stored in the router is replayed and updates are reevaluated. With this command, the replay and update process is triggered only if route-refresh request is not negotiated with the peer. If the request is indeed negotiated (upon execution of **clear ip bgp soft in**), then BGP sends a route-refresh request to the neighbor and receives all of the peer's updates.

To use soft reconfiguration, or soft reset, without preconfiguration, both BGP peers must support the soft route refresh capability, which is advertised in the open message sent when the peers establish a TCP session.

To determine whether a BGP router supports this capability, use the **show ip bgp neighbors** command. If a router supports the route refresh capability, the following message should be displayed:

```
Received route refresh capability from peer.
```

If you specify a BGP peer group by using the *peer-group-name* argument, all members of the peer group inherit the characteristic configured with this command.

The following example enables inbound soft reconfiguration for the neighbor 10.108.1.1. All updates received from this neighbor are stored unmodified, regardless of the inbound policy. When inbound soft reconfiguration is done later, the stored information is used to generate a new set of inbound updates.

```
FTOS>router bgp 100
  neighbor 10.108.1.1 remote-as 200
  neighbor 10.108.1.1 soft-reconfiguration inbound
```

Route map continue

The BGP route map **continue** feature (in ROUTE-MAP mode) allows movement from one route-map entry to a specific route-map entry (the *sequence number*). If the sequence number is not specified, the continue feature moves to the next sequence number (also known as an implied continue). If a match clause exists, the **continue** feature executes only after a successful match occurs. If there are no successful matches, **continue** is ignored.

continue [*sequence-number*]

Match Clause with a Continue Clause

The **continue** feature can exist without a match clause. Without a match clause, the continue clause executes and jumps to the specified route-map entry. With a match clause and a continue clause, the match clause executes first and the continue clause next in a specified route map entry. The continue clause launches only after a successful match. The behavior is:

- A successful match with a continue clause—the route map executes the set clauses and then goes to the specified route map entry upon execution of the continue clause.
- If the next route map entry contains a continue clause, the route map executes the continue clause if a successful match occurs.
- If the next route map entry does not contain a continue clause, the route map evaluates normally. If a match does not occur, the route map does not continue and falls-through to the next sequence number, if one exists.

Set Clause with a Continue Clause

If the route-map entry contains sets with the continue clause, then the set actions operation is performed first followed by the continue clause jump to the specified route map entry.

- If a set actions operation occurs in the first route map entry and then the same set action occurs with a different value in a subsequent route map entry, the last set of actions overrides the previous set of actions with the same **set** command.
- If the **set community additive** and **set as-path prepend** commands are configured, the communities and AS numbers are prepended.

MBGP Configuration

MBGP for IPv6 unicast is supported on platforms $E_t C$

MBGP for IPv4 Multicast is supported on platform $C E_t S$

MBGP is *not* supported on the E-Series ExaScale E_x platform.

Multiprotocol BGP (MBGP) is an enhanced BGP that carries IP multicast routes. BGP carries two sets of routes: one set for unicast routing and one set for multicast routing. The routes associated with multicast routing are used by the Protocol Independent Multicast (PIM) to build data distribution trees.

FTOS MBGP is implemented as per RFC 1858. The MBGP feature can be enabled per router and/or per peer/peer-group.

Default is IPv4 Unicast routes.

| Command Syntax | Command Mode | Purpose |
|--|-------------------|---|
| address family ipv4 multicast | CONFIG-ROUTER-BGP | Enables support for the IPv4 Multicast family on the BGP node |

| Command Syntax | Command Mode | Purpose |
|--|--|--|
| neighbor [<i>ip-address</i> <i>peer-group-name</i>] activate | CONFIG-ROUTER-BGP-AF (Address Family) | Enable IPv4 Multicast support on a BGP neighbor/peer group |

When a peer is configured to support IPv4 Multicast, FTOS takes the following actions:

- Send a capacity advertisement to the peer in the BGP Open message specifying IPv4 Multicast as a supported AFI/SAFI (Subsequent Address Family Identifier).
- If the corresponding capability is received in the peer's Open message, BGP will mark the peer as supporting the AFI/SAFI.
- When exchanging updates with the peer, BGP sends and receives IPv4 Multicast routes if the peer is marked as supporting that AFI/SAFI.
- Exchange of IPv4 Multicast route information occurs through the use of two new attributes called MP_REACH_NLRI and MP_UNREACH_NLRI, for feasible and withdrawn routes, respectively.
- If the peer has not been activated in any AFI/SAFI, the peer remains in Idle state.

Most FTOS BGP IPv4 Unicast commands are extended to support the IPv4 Multicast RIB using extra options to the command. Refer to the *FTOS Command Line Interface Reference* for a detailed description of the MBGP commands.

BGP Regular Expression Optimization

BGP policies that contain regular expressions to match against as-paths and communities might take a lot of CPU processing time, thus affect BGP routing convergence. Also, **show bgp** commands that get filtered through regular expressions can take a lot of CPU cycles, especially when the database is large. FTOS optimizes processing time when using regular expressions by caching and re-using regular expression evaluated results, at the expense of some memory in RP1 processor. This feature is turned on by default. Use the command **bgp regex-eval-optz-disable** in CONFIGURATION ROUTER BGP mode to disable it if necessary.

Debugging BGP

Use any of the commands in EXEC Privilege mode to enable BGP debugging.

| Command Syntax | Command Mode | Purpose |
|---|----------------|--|
| debug ip bgp [<i>ip-address</i> peer-group <i>peer-group-name</i>] [in out] | EXEC Privilege | View all information on BGP, including BGP events, keepalives, notifications, and updates. |
| debug ip bgp dampening [in out] | EXEC Privilege | View information on BGP route being dampened. |
| debug ip bgp [<i>ip-address</i> peer-group <i>peer-group-name</i>] events [in out] | EXEC Privilege | View information on local BGP state changes and other BGP events. |

| Command Syntax | Command Mode | Purpose |
|--|----------------|--|
| debug ip bgp [<i>ip-address</i> peer-group <i>peer-group-name</i>] keepalive [in out] | EXEC Privilege | View information about BGP KEEPALIVE messages. |
| debug ip bgp [<i>ip-address</i> peer-group <i>peer-group-name</i>] notifications [in out] | EXEC Privilege | View information about BGP notifications received from or sent to neighbors. |
| debug ip bgp [<i>ip-address</i> peer-group <i>peer-group-name</i>] updates [in out] [prefix-list name] | EXEC Privilege | View information about BGP updates and filter by prefix name |
| debug ip bgp { <i>ip-address</i> <i>peer-group-name</i> } soft-reconfiguration | EXEC Privilege | Enable soft-reconfiguration debug. Enable soft-reconfiguration debug. To enhance debugging of soft reconfig, use the following command only when route-refresh is not negotiated to avoid the peer from resending messages: bgp soft-reconfig-backup In-BGP is shown via the show ip protocols command. |

FTOS displays debug messages on the console. To view which debugging commands are enabled, use the **show debugging** command in EXEC Privilege mode.

Use the keyword **no** followed by the debug command To disable a specific debug command. For example, to disable debugging of BGP updates, enter **no debug ip bgp updates** command.

Use **no debug ip bgp** to disable all BGP debugging.

Use **undebug all** to disable all debugging.

Storing Last and Bad PDUs

FTOS stores the last notification sent/received, and the last bad PDU received on per peer basis. The last bad PDU is the one that causes a notification to be issued. These PDUs are shown in the output of the command **show ip bgp neighbor**, as shown in the example below.

```
FTOS(conf-router_bgp)#do show ip bgp neighbors 1.1.1.2

BGP neighbor is 1.1.1.2, remote AS 2, external link
  BGP version 4, remote router ID 2.4.0.1
  BGP state ESTABLISHED, in this state for 00:00:01
  Last read 00:00:00, last write 00:00:01
  Hold time is 90, keepalive interval is 30 seconds
  Received 1404 messages, 0 in queue
    3 opens, 1 notifications, 1394 updates
    6 keepalives, 0 route refresh requests
  Sent 48 messages, 0 in queue
    3 opens, 2 notifications, 0 updates
    43 keepalives, 0 route refresh requests
  Minimum time between advertisement runs is 30 seconds
  Minimum time before advertisements start is 0 seconds
```

```

Capabilities received from neighbor for IPv4 Unicast :
  MULTIPROTO_EXT(1)
  ROUTE_REFRESH(2)
  CISCO_ROUTE_REFRESH(128)

Capabilities advertised to neighbor for IPv4 Unicast :
  MULTIPROTO_EXT(1)
  ROUTE_REFRESH(2)
  CISCO_ROUTE_REFRESH(128)

For address family: IPv4 Unicast
BGP table version 1395, neighbor version 1394
Prefixes accepted 1 (consume 4 bytes), 0 withdrawn by peer
Prefixes advertised 0, rejected 0, 0 withdrawn from peer

Connections established 3; dropped 2
Last reset 00:00:12, due to Missing well known attribute

Notification History
'UPDATE error/Missing well-known attr' Sent : 1  Recv: 0
'Connection Reset' Sent : 1  Recv: 0

Last notification (len 21) sent 00:26:02 ago
  ffffffff ffffffff ffffffff ffffffff 00160303 03010000
Last notification (len 21) received 00:26:20 ago
  ffffffff ffffffff ffffffff ffffffff 00150306 00000000
Last PDU (len 41) received 00:26:02 ago that caused notification to be issued
  ffffffff ffffffff ffffffff ffffffff 00290200 00000e01 02040201 00024003 04141414 0218c0a8
  01000000
Local host: 1.1.1.1, Local port: 179
Foreign host: 1.1.1.2, Foreign port: 41758

```

Capturing PDUs

Capture incoming and outgoing PDUs on a per-peer basis using the command **capture bgp-pdu neighbor direction**. Disable capturing using the no form of this command.

The buffer size supports a maximum value between 40 MB (the default) and 100 MB. The capture buffers are cyclic and reaching the limit prompts the system to overwrite the oldest PDUs when new ones are received for a given neighbor or direction. Setting the buffer size to a value lower than the current max, might cause captured PDUs to be freed to set the new limit.



Note: Memory on RP1 is not pre-allocated, and is allocated only when a PDU needs to be captured.

Use the command **capture bgp-pdu max-buffer-size** as shown in the example below to change the maximum buffer size. View the captured PDUs using the command **show capture bgp-pdu neighbor**.

```

FTOS#show capture bgp-pdu neighbor 20.20.20.2

Incoming packet capture enabled for BGP neighbor 20.20.20.2
Available buffer size 40958758, 26 packet(s) captured using 680 bytes
PDU[1] : len 101, captured 00:34:51 ago

```

```

ffffff fffffff fffffff fffffff 00650100 00000013 00000000 00000000 419ef06c 00000000
00000000 00000000 00000000 00000000 0181a1e4 0181a25c 41af92c0 00000000 00000000 00000000
00000000 00000001 0181a1e4 0181a25c 41af9400 00000000
PDU[2] : len 19, captured 00:34:51 ago
ffffff fffffff fffffff fffffff 00130400
PDU[3] : len 19, captured 00:34:51 ago
ffffff fffffff fffffff fffffff 00130400
PDU[4] : len 19, captured 00:34:22 ago
ffffff fffffff fffffff fffffff 00130400
[. . .]

Outgoing packet capture enabled for BGP neighbor 20.20.20.2
Available buffer size 40958758, 27 packet(s) captured using 562 bytes
PDU[1] : len 41, captured 00:34:52 ago
ffffff fffffff fffffff fffffff 00290104 000100b4 14141401 0c020a01 04000100 01020080
00000000
PDU[2] : len 19, captured 00:34:51 ago
ffffff fffffff fffffff fffffff 00130400
PDU[3] : len 19, captured 00:34:50 ago
ffffff fffffff fffffff fffffff 00130400
PDU[4] : len 19, captured 00:34:20 ago
ffffff fffffff fffffff fffffff 00130400
[. . .]

```

The buffers storing the PDU free memory when:

- BGP is disabled
- A neighbor is unconfigured
- **clear ip bgp** is issued
- New PDU are captured and there is no more space to store them
- The max buffer size is reduced. (This may cause PDUs to be cleared depending upon the buffer space consumed and the new limit.)

With full internet feed (205K) captured, approximately 11.8MB is required to store all of the PDUs, as shown in the following example.

```

FTOS(conf-router_bgp)#do show capture bgp-pdu neighbor 172.30.1.250

Incoming packet capture enabled for BGP neighbor 172.30.1.250
Available buffer size 29165743, 192991 packet(s) captured using 11794257 bytes
[. . .]

FTOS(conf-router_bgp)#do sho ip bg s
BGP router identifier 172.30.1.56, local AS number 65056
BGP table version is 313511, main routing table version 313511
207896 network entrie(s) and 207896 paths using 42364576 bytes of memory
59913 BGP path attribute entrie(s) using 2875872 bytes of memory
59910 BGP AS-PATH entrie(s) using 2679698 bytes of memory
3 BGP community entrie(s) using 81 bytes of memory

Neighbor      AS      MsgRcvd  MsgSent      TblVer  InQ   OutQ  Up/Down  State/Pfx
1.1.1.2       2          17      18966         0       0     0 00:08:19 Active

```

PDU Counters

FTOS version 7.5.1.0 introduces additional counters for various types of PDUs sent and received from neighbors. These are seen in the output of the command **show ip bgp neighbor**.

Sample Configurations

The following configurations are examples for enabling BGP and setting up some peer groups. These are not comprehensive directions. They are intended to give you a some guidance with typical configurations.

You can copy and paste from these examples to your CLI. Be sure you make the necessary changes to support your own IP Addresses, Interfaces, Names, etc.

The image below is a graphic illustration of the configurations shown on the following pages. These configurations show how to create BGP areas using physical and virtual links. They include setting up the interfaces and peers groups with each other.

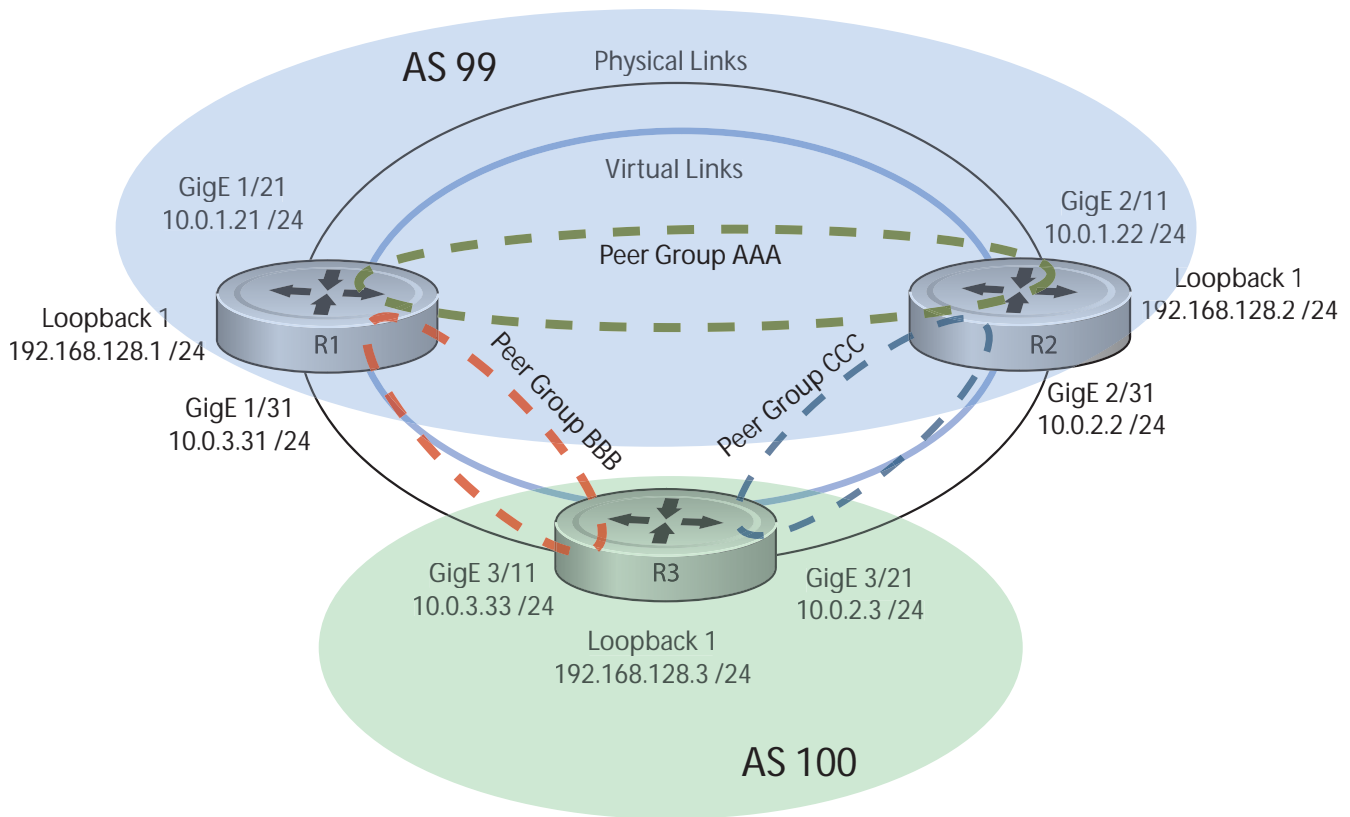

Example: Enable BGP, Router 1

```

R1# conf
R1(conf)#int loop 0
R1(conf-if-lo-0)#ip address 192.168.128.1/24
R1(conf-if-lo-0)#no shutdown
R1(conf-if-lo-0)#show config
!
interface Loopback 0
 ip address 192.168.128.1/24
 no shutdown
R1(conf-if-lo-0)#int gig 1/21
R1(conf-if-gi-1/21)#ip address 10.0.1.21/24
R1(conf-if-gi-1/21)#no shutdown
R1(conf-if-gi-1/21)#show config
!
interface GigabitEthernet 1/21
 ip address 10.0.1.21/24
 no shutdown
R1(conf-if-gi-1/21)#int gig 1/31
R1(conf-if-gi-1/31)#ip address 10.0.3.31/24
R1(conf-if-gi-1/31)#no shutdown
R1(conf-if-gi-1/31)#show config
!
interface GigabitEthernet 1/31
 ip address 10.0.3.31/24
 no shutdown
R1(conf-if-gi-1/31)#router bgp 99
R1(conf-router_bgp)#network 192.168.128.0/24
R1(conf-router_bgp)#neighbor 192.168.128.2 remote 99
R1(conf-router_bgp)#neighbor 192.168.128.2 no shut
R1(conf-router_bgp)#neighbor 192.168.128.2 update-source loop 0
R1(conf-router_bgp)#neighbor 192.168.128.3 remote 100
R1(conf-router_bgp)#neighbor 192.168.128.3 no shut
R1(conf-router_bgp)#neighbor 192.168.128.3 update-source loop 0
R1(conf-router_bgp)#show config
!
router bgp 99
 network 192.168.128.0/24
 neighbor 192.168.128.2 remote-as 99
 neighbor 192.168.128.2 update-source Loopback 0
 neighbor 192.168.128.2 no shutdown
 neighbor 192.168.128.3 remote-as 100
 neighbor 192.168.128.3 update-source Loopback 0
 neighbor 192.168.128.3 no shutdown
R1(conf-router_bgp)#end
R1#
R1#show ip bgp summary
BGP router identifier 192.168.128.1, local AS number 99
BGP table version is 4, main routing table version 4
4 network entrie(s) using 648 bytes of memory
6 paths using 408 bytes of memory
BGP-RIB over all using 414 bytes of memory
3 BGP path attribute entrie(s) using 144 bytes of memory
2 BGP AS-PATH entrie(s) using 74 bytes of memory
2 neighbor(s) using 8672 bytes of memory

Neighbor          AS      MsgRcvd  MsgSent    TblVer  InQ   OutQ  Up/Down   State/Pfx

```



```

192.168.128.2   99           4           5           4   0   0 00:00:32   1
192.168.128.3  100          5           4           1   0   0 00:00:09   4
R1#

```

Example: Enable BGP, Router 2

```

R2# conf
R2(conf)#int loop 0
R2(conf-if-lo-0)#ip address 192.168.128.2/24
R2(conf-if-lo-0)#no shutdown
R2(conf-if-lo-0)#show config
!
interface Loopback 0
 ip address 192.168.128.2/24
 no shutdown
R2(conf-if-lo-0)#int gig 2/11
R2(conf-if-gi-2/11)#ip address 10.0.1.22/24
R2(conf-if-gi-2/11)#no shutdown
R2(conf-if-gi-2/11)#show config
!
interface GigabitEthernet 2/11
 ip address 10.0.1.22/24
 no shutdown
R2(conf-if-gi-2/11)#int gig 2/31
R2(conf-if-gi-2/31)#ip address 10.0.2.2/24
R2(conf-if-gi-2/31)#no shutdown
R2(conf-if-gi-2/31)#show config
!
interface GigabitEthernet 2/31
 ip address 10.0.2.2/24
 no shutdown
R2(conf-if-gi-2/31)#

R2(conf-if-gi-2/31)#router bgp 99
R2(conf-router_bgp)#network 192.168.128.0/24
R2(conf-router_bgp)#neighbor 192.168.128.1 remote 99
R2(conf-router_bgp)#neighbor 192.168.128.1 no shut
R2(conf-router_bgp)#neighbor 192.168.128.1 update-source loop 0
R2(conf-router_bgp)#neighbor 192.168.128.3 remote 100
R2(conf-router_bgp)#neighbor 192.168.128.3 no shut
R2(conf-router_bgp)#neighbor 192.168.128.3 update loop 0
R2(conf-router_bgp)#show config
!
router bgp 99
 bgp router-id 192.168.128.2
 network 192.168.128.0/24
 bgp graceful-restart
 neighbor 192.168.128.1 remote-as 99
 neighbor 192.168.128.1 update-source Loopback 0
 neighbor 192.168.128.1 no shutdown
 neighbor 192.168.128.3 remote-as 100
 neighbor 192.168.128.3 update-source Loopback 0
 neighbor 192.168.128.3 no shutdown
R2(conf-router_bgp)#end

R2#show ip bgp summary

```

```

BGP router identifier 192.168.128.2, local AS number 99
BGP table version is 1, main routing table version 1
1 network entrie(s) using 132 bytes of memory
3 paths using 204 bytes of memory
BGP-RIB over all using 207 bytes of memory
2 BGP path attribute entrie(s) using 128 bytes of memory
2 BGP AS-PATH entrie(s) using 90 bytes of memory
2 neighbor(s) using 9216 bytes of memory

```

| Neighbor | AS | MsgRcvd | MsgSent | TblVer | InQ | OutQ | Up/Down | State/Pfx |
|---------------|-----|---------|---------|--------|-----|------|----------|-----------|
| 192.168.128.1 | 99 | 40 | 35 | 1 | 0 | 0 | 00:01:05 | 1 |
| 192.168.128.3 | 100 | 4 | 4 | 1 | 0 | 0 | 00:00:16 | 1 |

R2#

Example: Enable BGP, Router 3

```

R3# conf
R3(conf)#
R3(conf)#int loop 0
R3(conf-if-lo-0)#ip address 192.168.128.3/24
R3(conf-if-lo-0)#no shutdown
R3(conf-if-lo-0)#show config
!
interface Loopback 0
 ip address 192.168.128.3/24
 no shutdown
R3(conf-if-lo-0)#int gig 3/11
R3(conf-if-gi-3/11)#ip address 10.0.3.33/24
R3(conf-if-gi-3/11)#no shutdown
R3(conf-if-gi-3/11)#show config
!
interface GigabitEthernet 3/11
 ip address 10.0.3.33/24
 no shutdown

R3(conf-if-lo-0)#int gig 3/21
R3(conf-if-gi-3/21)#ip address 10.0.2.3/24
R3(conf-if-gi-3/21)#no shutdown
R3(conf-if-gi-3/21)#show config
!
interface GigabitEthernet 3/21
 ip address 10.0.2.3/24
 no shutdown

R3(conf-if-gi-3/21)#
R3(conf-if-gi-3/21)#router bgp 100
R3(conf-router_bgp)#show config
!
router bgp 100
R3(conf-router_bgp)#network 192.168.128.0/24
R3(conf-router_bgp)#neighbor 192.168.128.1 remote 99
R3(conf-router_bgp)#neighbor 192.168.128.1 no shut
R3(conf-router_bgp)#neighbor 192.168.128.1 update-source loop 0
R3(conf-router_bgp)#neighbor 192.168.128.2 remote 99
R3(conf-router_bgp)#neighbor 192.168.128.2 no shut
R3(conf-router_bgp)#neighbor 192.168.128.2 update loop 0
R3(conf-router_bgp)#show config

```

```

!
router bgp 100
 network 192.168.128.0/24
 neighbor 192.168.128.1 remote-as 99
 neighbor 192.168.128.1 update-source Loopback 0
 neighbor 192.168.128.1 no shutdown
 neighbor 192.168.128.2 remote-as 99
 neighbor 192.168.128.2 update-source Loopback 0
 neighbor 192.168.128.2 no shutdown
R3(conf)#end
R3#show ip bgp summary
BGP router identifier 192.168.128.3, local AS number 100
BGP table version is 1, main routing table version 1
1 network entrie(s) using 132 bytes of memory
3 paths using 204 bytes of memory
BGP-RIB over all using 207 bytes of memory
2 BGP path attribute entrie(s) using 128 bytes of memory
2 BGP AS-PATH entrie(s) using 90 bytes of memory
2 neighbor(s) using 9216 bytes of memory
Neighbor          AS      MsgRcvd  MsgSent      TblVer  InQ   OutQ  Up/Down  State/Pfx
192.168.128.1    99          24       25           1     0     0 00:14:20    1
192.168.128.2    99          14       14           1     0     0 00:10:22    1
R3#

```

Example: Enable Peer Group, Router 1

```

R1#conf
R1(conf)#router bgp 99
R1(conf-router_bgp)# network 192.168.128.0/24
R1(conf-router_bgp)# neighbor AAA peer-group
R1(conf-router_bgp)# neighbor AAA no shutdown
R1(conf-router_bgp)# neighbor BBB peer-group
R1(conf-router_bgp)# neighbor BBB no shutdown
R1(conf-router_bgp)# neighbor 192.168.128.2 peer-group AAA
R1(conf-router_bgp)# neighbor 192.168.128.3 peer-group BBB
R1(conf-router_bgp)#
R1(conf-router_bgp)#show config
!
router bgp 99
 network 192.168.128.0/24
 neighbor AAA peer-group
 neighbor AAA no shutdown
 neighbor BBB peer-group
 neighbor BBB no shutdown
 neighbor 192.168.128.2 remote-as 99
 neighbor 192.168.128.2 peer-group AAA
 neighbor 192.168.128.2 update-source Loopback 0
 neighbor 192.168.128.2 no shutdown
 neighbor 192.168.128.3 remote-as 100
 neighbor 192.168.128.3 peer-group BBB
 neighbor 192.168.128.3 update-source Loopback 0
 neighbor 192.168.128.3 no shutdown
R1#
R1#show ip bgp summary

```

```

BGP router identifier 192.168.128.1, local AS number 99
BGP table version is 1, main routing table version 1
1 network entrie(s) using 132 bytes of memory
3 paths using 204 bytes of memory
BGP-RIB over all using 207 bytes of memory
2 BGP path attribute entrie(s) using 96 bytes of memory
2 BGP AS-PATH entrie(s) using 74 bytes of memory
2 neighbor(s) using 8672 bytes of memory

```

| Neighbor | AS | MsgRcvd | MsgSent | TblVer | InQ | OutQ | Up/Down | State/Pfx |
|---------------|-----|---------|---------|--------|-----|------|----------|-----------|
| 192.168.128.2 | 99 | 23 | 24 | 1 | 0 | (0) | 00:00:17 | 1 |
| 192.168.128.3 | 100 | 30 | 29 | 1 | 0 | (0) | 00:00:14 | 1 |

```

!
R1#show ip bgp neighbors

```

```

BGP neighbor is 192.168.128.2, remote AS 99, internal link
Member of peer-group AAA for session parameters
BGP version 4, remote router ID 192.168.128.2
BGP state ESTABLISHED, in this state for 00:00:37
Last read 00:00:36, last write 00:00:36
Hold time is 180, keepalive interval is 60 seconds
Received 23 messages, 0 in queue
  2 opens, 0 notifications, 2 updates
  19 keepalives, 0 route refresh requests
Sent 24 messages, 0 in queue
  2 opens, 1 notifications, 2 updates
  19 keepalives, 0 route refresh requests
Minimum time between advertisement runs is 5 seconds
Minimum time before advertisements start is 0 seconds

```

Example: Enable Peer Groups, Router 1 (Continued)

```

Capabilities received from neighbor for IPv4 Unicast :

```

```

MULTIPROTO_EXT(1)
ROUTE_REFRESH(2)
CISCO_ROUTE_REFRESH(128)

```

```

Capabilities advertised to neighbor for IPv4 Unicast :

```

```

MULTIPROTO_EXT(1)
ROUTE_REFRESH(2)
CISCO_ROUTE_REFRESH(128)

```

```

Update source set to Loopback 0
Peer active in peer-group outbound optimization
For address family: IPv4 Unicast
BGP table version 1, neighbor version 1
Prefixes accepted 1 (consume 4 bytes), withdrawn 0 by peer
Prefixes advertised 1, denied 0, withdrawn 0 from peer

```

```

Connections established 2; dropped 1
Last reset 00:00:57, due to user reset

```

```

Notification History

```

```

'Connection Reset' Sent : 1 Recv: 0
Last notification (len 21) sent 00:00:57 ago
  ffffffff ffffffff ffffffff ffffffff 00150306 00000000
Local host: 192.168.128.1, Local port: 179
Foreign host: 192.168.128.2, Foreign port: 65464

```

```

BGP neighbor is 192.168.128.3, remote AS 100, external link
  Member of peer-group BBB for session parameters
  BGP version 4, remote router ID 192.168.128.3
  BGP state ESTABLISHED, in this state for 00:00:37
  Last read 00:00:36, last write 00:00:36
  Hold time is 180, keepalive interval is 60 seconds
  Received 30 messages, 0 in queue
    4 opens, 2 notifications, 4 updates
    20 keepalives, 0 route refresh requests
  Sent 29 messages, 0 in queue
    4 opens, 1 notifications, 4 updates
    20 keepalives, 0 route refresh requests
  Minimum time between advertisement runs is 30 seconds
  Minimum time before advertisements start is 0 seconds

  Capabilities received from neighbor for IPv4 Unicast :
    MULTIPROTO_EXT(1)
Capabilities received from neighbor for IPv4 Unicast :
  MULTIPROTO_EXT(1)
  ROUTE_REFRESH(2)
  CISCO_ROUTE_REFRESH(128)
Update source set to Loopback 0
  Peer active in peer-group outbound optimization
For address family: IPv4 Unicast
  BGP table version 1, neighbor version 1
  Prefixes accepted 1 (consume 4 bytes), withdrawn 0 by peer
  Prefixes advertised 1, denied 0, withdrawn 0 from peer
Connections established 4; dropped 3
  Last reset 00:00:54, due to user reset
R1#

```

Example: Enable Peer Groups, Router 2

```

R2#conf
R2(conf)#router bgp 99
R2(conf-router_bgp)# neighbor CCC peer-group
R2(conf-router_bgp)# neighbor CC no shutdown
R2(conf-router_bgp)# neighbor BBB peer-group
R2(conf-router_bgp)# neighbor BBB no shutdown
R2(conf-router_bgp)# neighbor 192.168.128.1 peer AAA
R2(conf-router_bgp)# neighbor 192.168.128.1 no shut
R2(conf-router_bgp)# neighbor 192.168.128.3 peer BBB
R2(conf-router_bgp)# neighbor 192.168.128.3 no shut
R2(conf-router_bgp)#show conf
!
router bgp 99
  network 192.168.128.0/24
  neighbor AAA peer-group
  neighbor AAA no shutdown
  neighbor BBB peer-group
  neighbor BBB no shutdown
  neighbor 192.168.128.1 remote-as 99
  neighbor 192.168.128.1 peer-group CCC
  neighbor 192.168.128.1 update-source Loopback 0
  neighbor 192.168.128.1 no shutdown
  neighbor 192.168.128.3 remote-as 100
  neighbor 192.168.128.3 peer-group BBB

```

```
neighbor 192.168.128.3 update-source Loopback 0
neighbor 192.168.128.3 no shutdown
R2(conf-router_bgp)#end
```

```
R2#
```

```
R2#show ip bgp summary
BGP router identifier 192.168.128.2, local AS number 99
BGP table version is 2, main routing table version 2
1 network entrie(s) using 132 bytes of memory
3 paths using 204 bytes of memory
BGP-RIB over all using 207 bytes of memory
2 BGP path attribute entrie(s) using 128 bytes of memory
2 BGP AS-PATH entrie(s) using 90 bytes of memory
2 neighbor(s) using 9216 bytes of memory
```

| Neighbor | AS | MsgRcvd | MsgSent | TblVer | InQ | OutQ | Up/Down | State/Pfx |
|---------------|-----|---------|---------|--------|-----|------|----------|-----------|
| 192.168.128.1 | 99 | 140 | 136 | 2 | 0 | (0) | 00:11:24 | 1 |
| 192.168.128.3 | 100 | 138 | 140 | 2 | 0 | (0) | 00:18:31 | 1 |

```
R2#show ip bgp neighbor
```

```
BGP neighbor is 192.168.128.1, remote AS 99, internal link
Member of peer-group AAA for session parameters
BGP version 4, remote router ID 192.168.128.1
BGP state ESTABLISHED, in this state for 00:11:42
Last read 00:00:38, last write 00:00:38
Hold time is 180, keepalive interval is 60 seconds
Received 140 messages, 0 in queue
  6 opens, 2 notifications, 19 updates
  113 keepalives, 0 route refresh requests
Sent 136 messages, 0 in queue
  12 opens, 3 notifications, 6 updates
  115 keepalives, 0 route refresh requests
Minimum time between advertisement runs is 5 seconds
Minimum time before advertisements start is 0 seconds
```

Example: Enable Peer Groups, Router 3

```
R3#conf
```

```
R3(conf)#router bgp 100
R3(conf-router_bgp)# neighbor AAA peer-group
R3(conf-router_bgp)# neighbor AAA no shutdown
R3(conf-router_bgp)# neighbor CCC peer-group
R3(conf-router_bgp)# neighbor CCC no shutdown
R3(conf-router_bgp)# neighbor 192.168.128.2 peer-group BBB
R3(conf-router_bgp)# neighbor 192.168.128.2 no shutdown
R3(conf-router_bgp)# neighbor 192.168.128.1 peer-group BBB
R3(conf-router_bgp)# neighbor 192.168.128.1 no shutdown
R3(conf-router_bgp)#
```

```
R3(conf-router_bgp)#end
```

```
R3#show ip bgp summary
```

```
BGP router identifier 192.168.128.3, local AS number 100
BGP table version is 1, main routing table version 1
1 network entrie(s) using 132 bytes of memory
3 paths using 204 bytes of memory
BGP-RIB over all using 207 bytes of memory
```

```
2 BGP path attribute entrie(s) using 128 bytes of memory
2 BGP AS-PATH entrie(s) using 90 bytes of memory
2 neighbor(s) using 9216 bytes of memory
```

| Neighbor | AS | MsgRcvd | MsgSent | TblVer | InQ | OutQ | Up/Down | State/Pfx |
|---------------|----|---------|---------|--------|-----|------|----------|-----------|
| 192.168.128.1 | 99 | 93 | 99 | 1 | 0 | (0) | 00:00:15 | 1 |
| 192.168.128.2 | 99 | 122 | 120 | 1 | 0 | (0) | 00:00:11 | 1 |

```
R3#show ip bgp neighbor
```

```
BGP neighbor is 192.168.128.1, remote AS 99, external link
Member of peer-group BBB for session parameters
BGP version 4, remote router ID 192.168.128.1
BGP state ESTABLISHED, in this state for 00:00:21
Last read 00:00:09, last write 00:00:08
Hold time is 180, keepalive interval is 60 seconds
Received 93 messages, 0 in queue
  5 opens, 0 notifications, 5 updates
  83 keepalives, 0 route refresh requests
Sent 99 messages, 0 in queue
  5 opens, 4 notifications, 5 updates
  85 keepalives, 0 route refresh requests
Minimum time between advertisement runs is 30 seconds
Minimum time before advertisements start is 0 seconds
```

```
Capabilities received from neighbor for IPv4 Unicast :
MULTIPROTO_EXT(1)
ROUTE_REFRESH(2)
CISCO_ROUTE_REFRESH(128)
```

```
Capabilities advertised to neighbor for IPv4 Unicast :
MULTIPROTO_EXT(1)
ROUTE_REFRESH(2)
CISCO_ROUTE_REFRESH(128)
```

```
Update source set to Loopback 0
Peer active in peer-group outbound optimization
```

```
For address family: IPv4 Unicast
BGP table version 1, neighbor version 1
Prefixes accepted 1 (consume 4 bytes), withdrawn 0 by peer
Prefixes advertised 1, denied 0, withdrawn 0 from peer
```

Example: Enable Peer Groups, Router 3 (Continued)

```
Capabilities received from neighbor for IPv4 Unicast :
MULTIPROTO_EXT(1)
ROUTE_REFRESH(2)
CISCO_ROUTE_REFRESH(128)
```

```
Capabilities advertised to neighbor for IPv4 Unicast :
MULTIPROTO_EXT(1)
ROUTE_REFRESH(2)
CISCO_ROUTE_REFRESH(128)
```

```
Update source set to Loopback 0
Peer active in peer-group outbound optimization
```

```

For address family: IPv4 Unicast
BGP table version 2, neighbor version 2
Prefixes accepted 1 (consume 4 bytes), withdrawn 0 by peer
Prefixes advertised 1, denied 0, withdrawn 0 from peer

Connections established 6; dropped 5
Last reset 00:12:01, due to Closed by neighbor

Notification History
'HOLD error/Timer expired' Sent : 1  Recv: 0
'Connection Reset' Sent : 2  Recv: 2

Last notification (len 21) received 00:12:01 ago
ffffff fffffff fffffff fffffff 00150306 00000000
Local host: 192.168.128.2, Local port: 65464
Foreign host: 192.168.128.1, Foreign port: 179

BGP neighbor is 192.168.128.3, remote AS 100, external link
Member of peer-group BBB for session parameters
BGP version 4, remote router ID 192.168.128.3
BGP state ESTABLISHED, in this state for 00:18:51
Last read 00:00:45, last write 00:00:44
Hold time is 180, keepalive interval is 60 seconds
Received 138 messages, 0 in queue
  7 opens, 2 notifications, 7 updates
  122 keepalives, 0 route refresh requests
Sent 140 messages, 0 in queue
  7 opens, 4 notifications, 7 updates
  122 keepalives, 0 route refresh requests
Minimum time between advertisement runs is 30 seconds
Minimum time before advertisements start is 0 seconds
Capabilities advertised to neighbor for IPv4 Unicast :
  MULTIPROTO_EXT(1)
Capabilities received from neighbor for IPv4 Unicast :
  MULTIPROTO_EXT(1)
  ROUTE_REFRESH(2)
  CISCO_ROUTE_REFRESH(128)
ROUTE_REFRESH(2)
  CISCO_ROUTE_REFRESH(128)

Update source set to Loopback 0
Peer active in peer-group outbound optimization
For address family: IPv4 Unicast
BGP table version 2, neighbor version 2
Prefixes accepted 1 (consume 4 bytes), withdrawn 0 by peer
Prefixes advertised 1, denied 0, withdrawn 0 from peer

```

Bare Metal Provisioning 2.0

Bare Metal Provisioning 2.0 is included as part of the FTOS image. It is supported on the following platforms: **S4810** and **S4820T**

Bare Metal Provisioning (BMP) improves accessibility to the switch by automatically loading pre-defined configurations and boot images that are stored in file servers. BMP can be used on a single switch or on multiple switches.



Note: Some of the configuration examples in this chapter use “S4810” within their commands. These examples work just as well if “S4820T” is used.

For more information on using BMP and the different types of modes, refer to the *Open Automation Guide*.

BMP eases configuration by providing the following key features:

- Boot images and running configurations are specified in a DHCP server.
- Files are automatically downloaded from a file server and applied by the switch.
- Switch access is allowed through all ports (management and user ports) with or without DHCP-based dynamic IP address configuration of a switch.
- Booting up in Layer 3 mode with interfaces already in no shutdown mode and only enabling some basic protocols to protect the switch and the network.

BMP is enabled on a brand new, factory-loaded switch. For switches that do not have BMP already enabled, use the following steps to enable the feature:

1. Configure an auto-configuration mode using the **reload-type** command.
2. Reload the switch in the configured mode using the **reload** command.

Prerequisites

Before you use BMP 2.0 to auto-configure a supported Dell Force10 switch, you must first configure a Dynamic Host Configuration Protocol (DHCP) server and a file server in the network. Optionally, you can also configure a Domain Name Server (DNS). For more information, refer to [DHCP Server](#), [Domain Name Server](#), and [File Server](#).



Note: If the switch is connected to upstream aggregation switches that have VLT enabled and the DHCP and file servers are reachable through the VLT LAG interface, you must configure the VLT members with the **lacp ungroup member-independent vlt** command. This allows the bottom switch to establish communication with the VLT switches.

Restrictions

BMP 2.0 is supported on the user ports and management ports of a switch.

Overview

On a new factory-loaded switch, the switch boots up in **Jumpstart** mode. You can reconfigure a switch to reload between **Normal** and **Jumpstart** mode.

- **Jumpstart (BMP) mode:** The switch automatically configures all ports (management and user ports) as Layer 3 physical ports and acts as a DHCP client on the ports for a user-configured time (DHCP timeout). This is the default startup mode. It is set with the **reload-type jump-start** command.
- **Normal mode:** The switch loads the FTOS image and startup configuration file stored in the local flash. New configurations require that the Management IP and Management Interface be configured manually. This mode is set with the **reload-type normal-reload** command.

To reconfigure a switch to reload between **Normal** and **Jumpstart** mode, use the **reload-type** command.

| Command Syntax | Command Mode | Purpose |
|--|----------------|--|
| reload-type { normal-reload jump-start [config-download { <i>enable</i> <i>disable</i> }] [dhcp-timeout <i>minutes</i>]} | EXEC Privilege | <p>Reload a switch running BMP version 2.0 in either Normal or Jumpstart mode. If you reload in Jumpstart mode, you can configure:</p> <ul style="list-style-type: none"> • config-download: Whether the switch boots up using the configuration file downloaded from the DHCP/file servers (<i>enable</i>) OR if the downloaded file will be discarded and the startup configuration file stored in the local flash will be used (<i>disable</i>). • dhcp-timeout: The amount of time the switch waits for a DHCP server response before reverting to Normal mode and loading the startup configuration from the flash. The default time is infinity, which makes the switch continue to wait forever unless the stop jump-start command is given. Range: 1 to 50 minutes. Default: The switch tries to contact a DHCP server an infinite number of times. |
| stop jump-start | EXEC Privilege | <p>This command stops the jumpstart reload process while it is in progress and changes the reload type to Normal mode.</p> <p>If the command is initiated while the switch is downloading an image or configuration file, the command takes effect when the DHCP release is sent.</p> |

The reload settings that you configure with the **reload-type** command are stored in non-volatile memory and retained for future reboots. Enter the **reload** command to reload the switch in the current configured mode: Normal or Jumpstart mode.

To display the currently configured reload mode for a switch running BMP version 2.0, enter the **show reload-type** or **show bootvar** command.

```
FTOS#show reload type
Reload-Type      :   jump-start [Next boot :jump-start]
config-download  :   enable
dhcp-timeout     :    10

FTOS#show bootvar
. . content truncated..
Reload Mode =   jump-start
File URL =  tftp://30.0.0.1/FTOS-SE-8-3-8-17.bin
```

If a switch enters a loop while reloading in Jumpstart mode because it continuously tries to contact a DHCP server and a DHCP server is not found, enter the **stop jump-start** command to interrupt the repeated discovery attempts. The startup configuration file stored in the local flash on the switch is loaded as part of the **stop jump-start** command and the auto-configuration mode is changed to **Normal** reload.

Jumpstart mode

Jumpstart (BMP) mode is the default boot mode configured for a new switch arriving from Dell Force10. This mode obtains the FTOS image and configuration file from a network source (DHCP server and file server).

DHCP Server

DHCP Configuration

You must first configure an external DHCP server before you can use the Jumpstart mode on a switch. Configure the DHCP server with the set of parameters described below for each client switch. Refer to the *FTOS Configuration Guide: Dynamic Host Configuration Protocol* chapter for detailed information. The DHCP server is configured to assign an IP address to the switch and specify the files to download.

One or more of the following parameters must be configured on the DHCP server.

- **Boot File Name:** The FTOS image to be loaded on the switch. The boot file name is expected to use Option 67 or the boot filename in the boot payload of the DHCP offer. If both are specified, Option 67 will be used.
- **Configuration File Name:** The configurations to be applied to the switch. The configuration file name is expected to use Option 209.
- **File Server Address:** The server where the Image and Configurations file are placed. The address is assumed to be a TFTP address unless it is given as a URL. The switch supports TFTP, HTTP, and FTP protocols, as well as files stored in Flash. If TFTP is used, you can add Option 66 or Option 150.
- **Domain Name Server:** (Optional.) The DNS server to be contacted to resolve the hostname through Option 6.
- **IP Address:** Dynamic IP address for the switch. This is used only for file transfers.

The DHCP option codes used are:

- 6 Domain Name Server IP
- 66 TFTP Server name
- 67 Boot filename
- 150 TFTP server IP address
- 209 Configuration File



Note: The boot file name and configuration file name must be in the correct format. If it is not, the switch will be unable to download the file from the DHCP server, and will behave as if the server could not be reached. The discovery process will continue, despite configured time-out, until the **stop jump-start** command is given.

URL Examples

FTOS image

```
option bootfile-name "ftp://user:passwd@myserver/
FTOS-SE-8.3.10.1.bin";
```

Description

FTP URL with hostname
(requires DNS)

```
option bootfile-name "http://10.20.4.1/FTOS-SE-8.3.10.1.bin";
```

HTTP URL with IP address

```
option bootfile-name "tftp://10.20.4.1/
FTOS-SE-8.3.10.1.bin";
```

TFTP URL with IP address

```
option bootfile-name "flash://FTOS-SE-8.3.10.1.bin";
```

Flash path relative to /f10/flash
directory

Configuration file could be given in the following way

```
option config-file "ftp://user:passwd@10.20.4.1//home/user/
S4810-1.conf";
```

FTP URL with IP address

```
option config-file "http://myserver/S4810-1.conf";
```

HTTP URL with hostname
(requires DNS)

```
option config-file "tftp://10.10.4.1/S4810-1.conf";
```

TFTP URL with IP address

```
option config-file "flash://S4810-1.conf";
```

Flash path relative to /f10/flash
directory

MAC-Based IP assignment

One way to use the BMP mode most efficiently is to configure the DHCP server to assign a fixed IP address, FTOS image, and configuration file based on the switch's MAC address. When this is done, the same IP address is assigned to the switch even on repetitive reloads and the same configuration file will be retrieved when using the DNS server or the **network-config** file to determine the hostname.

The assigned IP address is only used to retrieve the files from the file server. It is discarded after the files are retrieved.

Following is an example of a configuration of the DHCP server included on the most popular Linux distributions. The **dhcpd.conf** file shows assignment of a fixed IP address and configuration file based on the MAC address of the switch.

| Parameter Example | Description |
|---|--|
| <pre>option boot-filename code 67 = text; option tftp-server-address code 150 = ip-address; option config-file code 209 = text; subnet 10.20.30.0 netmask 255.255.255.0 { option domain-name-servers 20.30.40.1, 20.30.40.2; host S4810-1 { hardware ethernet 00:01:e8:8c:4d:0e; fixed-address 10.20.30.41; option boot-filename "tftp://10.20.4.1/FTOS-SE-8.3.10.1.bin"; option config-file "http://10.20.4.1/S4810-1.conf"; } host S4810-2 { hardware ethernet 00:01:e8:8c:4c:04; fixed-address 10.20.30.42; option tftp-server-address 10.20.4.1; filename "FTOS-SE-8.3.10.1.bin"; option config-file "S4810-2.conf"; } }</pre> | <p>BMP 2.0 Syntax</p> <p>MAC to IP mapping</p> <p>FTOS image</p> <p>Config file</p> <p>BMP1.0 syntax</p> <p>MAC to IP mapping</p> <p>FTOS image</p> <p>Config file</p> |

DHCP Retry Mechanism

BMP will request a different DHCP offer in the following scenarios:

- If the command **reload-type config-download** is enabled, the DHCP offer specifies both the boot image and the configuration file, and either download is successful, BMP will not request another DHCP offer.
- If the offer contains only a boot image that cannot be downloaded, BMP will request another DHCP offer.
- If the command **reload-type config-download** is enabled and the configuration file in the offer cannot be downloaded, BMP will request another DHCP offer.

DHCP Server IP Blacklist

If the process does not complete successfully, the DHCP server IP will be blacklisted and the DHCP process will be re-initiated. A DHCP server is maintained in the blacklist for ten minutes. If a DHCP offer is received from the blacklisted DHCP server, the offer will be rejected.

File Server

Set up a file server and ensure connectivity.

The server that holds the boot and configuration files must be configured as the network source for the switch. The switch recognizes HTTP, TFTP, FTP, and Flash URLs.

For example:

- tftp://serverip/filename
- tftp://hostname/filename
- ftp://user:passwd@serverip//mypath/filename
- ftp://user:passwd@hostname//mypath/filename
- http://serverip/filename
- http://hostname/filename
- flash://filename
- filename (Assumes TFTP)

When loading the FTOS image, if the FTOS image on the server is different from the image on the local flash, the switch downloads the image from the server onto the local flash and reloads using that image.

Next, the switch tries to load the configuration file. If the configuration file is not specified or if the **config-download** parameter is disabled, the switch loads the startup-config from the local flash.

Domain Name Server

Set up a Domain Name Server (DNS) to determine the host name applied in the switch startup configuration when no configuration file is retrieved from the DHCP server. The DNS server is contacted only when no configuration file is contained in a DHCP server response and the host name is not resolved from the network-config file on the switch. Refer to the *FTOS Configuration Guide IPv4 Addressing* chapter, *Resolution of Host Names* for information.

Switch boot and set-up behavior in Jumpstart Mode

When the switch boots up in jumpstart mode all ports, including management ports, are placed in **L3** mode in a **no shut** state. The switch acts as a DHCP client on these ports for a period of time (dhcp-timeout). This allows the switch time to send out a DHCP DISCOVER on all the **interface up** ports to the DHCP Server in order to obtain its IP address, boot image filename and configuration file from the DHCP server.

1. The switch begins boot up process in jumpstart mode (default mode)
2. The switch sends DHCP Discover on all the interface up ports.

```
00:01:31: %STKUNIT0-M:CP %JUMPSTART-5-JUMPSTART_DISCOVER: DHCP DISCOVER sent on Ma 0/0.
00:01:31: %STKUNIT0-M:CP %JUMPSTART-5-JUMPSTART_DISCOVER: DHCP DISCOVER sent on Te 0/0.
00:01:31: %STKUNIT0-M:CP %JUMPSTART-5-JUMPSTART_DISCOVER: DHCP DISCOVER sent on Te 0/5.
00:01:31: %STKUNIT0-M:CP %JUMPSTART-5-JUMPSTART_DISCOVER: DHCP DISCOVER sent on Te 0/6.
00:01:47: %STKUNIT0-M:CP %JUMPSTART-5-JUMPSTART_DISCOVER: DHCP DISCOVER sent on Te 0/8.
00:01:47: %STKUNIT0-M:CP %JUMPSTART-5-JUMPSTART_DISCOVER: DHCP DISCOVER sent on Te 0/35.
00:01:47: %STKUNIT0-M:CP %JUMPSTART-5-JUMPSTART_DISCOVER: DHCP DISCOVER sent on Fo 0/56.
00:01:47: %STKUNIT0-M:CP %JUMPSTART-5-JUMPSTART_DISCOVER: DHCP DISCOVER sent on Fo 0/60.
00:01:47: %STKUNIT0-M:CP %JUMPSTART-5-JUMPSTART_DISCOVER: DHCP DISCOVER sent on Ma 0/0.
```

3. The IP address, boot image filename and the configuration filename are reserved for the switch and provided in the DHCP reply (one-file read method). The switch receives its IP address, subnet mask, DHCP server IP, TFTP server address, DNS server IP, bootfile name and the configuration filename from the DHCP server.

If a DHCP offer has no image path or configuration file path it is considered to be an invalid BMP DHCP offer, the offer is ignored. The first DHCP offer with IP address, FTOS image and configuration file, *or* the IP address and FTOS image, *or* the IP address and configuration file is chosen.

4. The DHCP OFFER is selected.
 - a All other ports are set to shutdown mode.

```
00:01:33: %STKUNIT0-M:CP %JUMPSTART-5-DHCP_OFFER: DHCP acquired IP 30.0.0.20 mask 255.255.0.0 server IP 30.1.1.1.
00:01:33: %STKUNIT0-M:CP %JUMPSTART-5-DHCP_OFFER: DHCP tftp IP 30.0.0.1 dns IP 30.0.0.1 router IP 30.0.0.14.
00:01:33: %STKUNIT0-M:CP %JUMPSTART-5-DHCP_OFFER: DHCP image file FTOS-SE-8.3.10.1.bin.
00:01:33: %STKUNIT0-M:CP %JUMPSTART-5-DHCP_OFFER: DHCP config file pt-s4810-12.
```

5. The switch sends a unicast message to the file server to retrieve the named FTOS file and/or the configuration file from the base directory of the server.
 - a If an option **bootfile-name** is used, the file name can be 256 bytes. If a **filename** field is specified in the DHCP Offer, the filename can be 128 bytes. The name can be a fully qualified URL or it can be a file name only.
 - b When an FTOS image is found, the switch compares that image to the version the chassis currently has loaded.
 - If there is a mismatch, the switch applies the downloaded version and reloads.

```
*****VALID IMAGE*****
```

```
DOWNLOADED RELEASE HEADER :
Release Image Major Version : 8
Release Image Minor Version : 3
Release Image Main Version : 8
Release Image Patch Version : 33
```

```
FLASH RELEASE HEADER B :
Release Image Major Version : 8
Release Image Minor Version : 3
Release Image Main Version : 10
Release Image Patch Version : 1
```

```
00:04:05: %STKUNIT0-M:CP %JUMPSTART-5-JUMPSTART_DOWNLOAD: The FTOS image download is successful.
```

```
Erasing Sseries Primary Image, please wait
```

```
.....
.....
.....
.....
```

```
.....00:09:50: %STKUNsyncing disks... IT0-M:CP %CHMGR-1
```

```
5-RELOAD: User done
request to reload the chassis
rebooting
```

- If there is no version mismatch the switch downloads the configuration file.

```
00:03:27: %STKUNIT0-M:CP %JUMPSTART-5-CFG_APPLY: The downloaded config from dhcp
server is being applied
00:03:27: %STKUNIT0-M:CP %JUMPSTART-5-JUMPSTART_RELEASE: DHCP RELEASE sent on Fo 0/56.
00:03:27: %STKUNIT0-M:CP %SYS-5-CONFIG_LOAD: Loading configuration file
```

- c If the configuration file is downloaded from the server, any saved startup-configuration on the flash is ignored. If no configuration file is downloaded from the server or the **config-download** parameter is disable, the startup-configuration file on the flash is loaded as in normal reload.
6. When the FTOS image and the configuration file have been downloaded, the IP address is released.

```
00:04:06: %STKUNIT0-M:CP %JUMPSTART-5-JUMPSTART_RELEASE: DHCP RELEASE sent on Fo 0/56.  
00:04:06: %STKUNIT0-M:CP %IFMGR-5-ASTATE_DN: Changed interface Admin state to down: Fo 0/56
```
 7. The switch applies the configuration. The switch is now up and running. It can be managed as usual.

Content Addressable Memory (CAM)

Content Addressable Memory (CAM) is supported on platforms: e t C S **S4810**

S4820T

- [Content Addressable Memory](#)
- [CAM Profiles](#)
- [Microcode](#)
- [CAM Profiling for ACLs](#)
- [When to Use CAM Profiling](#)
- [Differences Between EtherScale and TeraScale](#)
- [Important Points to Remember](#)
- [Select CAM Profiles](#)
- [CAM Allocation](#)
- [Test CAM Usage](#)
- [View CAM Profiles](#)
- [View CAM-ACL settings](#)
- [View CAM-ACL settings](#)
- [Configure IPv4Flow Sub-partitions](#)
- [Configure Ingress Layer 2 ACL Sub-partitions](#)
- [Return to the Default CAM Configuration](#)
- [CAM Optimization](#)
- [Applications for CAM Profiling](#)
- [Troubleshoot CAM Profiling](#)

Content Addressable Memory

Content Addressable Memory (CAM) is a type of memory that stores information in the form of a lookup table. On Dell Force10 systems, the CAM stores Layer 2 and Layer 3 forwarding information, access-lists (ACL), flows, and routing policies. On Dell Force10 systems, there are one or two CAM (Dual-CAM) modules per port-pipe depending on the type of line card.

- The ExaScale EH and EJ series line cards are single-CAM line cards that support 10M and 40M CAM for storing the lookup information.

- The TeraScale EG-series line cards are dual-CAM and use two 18 Megabit CAM modules with a dedicated 512 IPv4 Forwarding Information Base (FIB), and flexible CAM allocations for Layer2, FIB, and ACLs.
- Either ExaScale 10G or 40G CAM line cards can be used in a system.

CAM Profiles

Dell Force10 systems partition each CAM module so that it can store the different types of information. The size of each partition is specified in the CAM profile. A CAM profile is stored on every card, including each RPM. The same profile must be on every line card and RPM in the chassis.

There is a default CAM profile and several other CAM profiles available so that you can partition the CAM according to your performance requirements. For example, the default profile has 1K Layer 2 ingress ACL entries. If you need more memory for Layer 2 ingress ACLs, select the profile *l2-ipv4-inacl*.

[Table 11-1](#) describes the available profiles. The default profile is an all-purpose profile that allocates CAM space according to the way Dell Force10 systems are most commonly used. In general, non-default profiles allocate more space to particular regions to accommodate specific applications. The size of CAM partitions is measured in entries. The total CAM space is finite, therefore adding entries to one region necessarily decreases the number available to other regions.



Note: Not all CAM profiles and microcodes are available for all systems. Refer to the *Command Line Interface Reference Guide* for details regarding available profiles for each system.

Table 11-1. CAM Profile Descriptions

| CAM Profile | Description |
|----------------|---|
| Default | An all-purpose profile that allocates CAM space according to the way Dell Force10 systems are most commonly used. Available Microcodes: default, lag-hash-align, lag-hash-mpls |
| eg-default | For EG-series line cards only. EG series line cards have two CAM modules per Port-pipe. Available Microcodes: default, ipv6-extacl |
| ipv4-320k | Provides 320K entries for the IPv4 Forwarding Information Base (FIB) and reduces the IPv4 Flow partition to 12K. Available Microcodes: default, lag-hash-mpls |
| ipv4-egacl-16k | Provides 16K entries for egress ACLs Available Microcodes: acl-group |
| ipv6-extacl | Provides IPv6 functionality. Available Microcodes: ipv6-extacl |
| l2-ipv4-inacl | Provides 32K entries for Layer 2 ingress ACLs and 28K entries for Layer 3 IPv4 ingress ACLs. Available Microcodes: default |

Table 11-1. CAM Profile Descriptions

| CAM Profile | Description |
|-----------------|---|
| unified-default | Maintains the CAM allocations for the and IPv4 FIB while allocating more CAM space for the Ingress and Egress Layer 2 ACL, and IPv4 ACL regions. Available Microcodes: ipv6-extacl |
| ipv4-64k-ipv6 | Provides IPv6 functionality; an alternate to ipv6-extacl that redistributes CAM space from the IPv4FIB to IPv4Flow and IPv6FIB. Available Microcodes: ipv6-extacl |

The size of CAM partitions is measured in entries. [Table 11-1](#) shows the number of entries available in each partition for all CAM profiles. The total CAM space is finite, therefore adding entries to one region necessarily decreases the number available to other regions.

Table 11-2. CAM entries per partition

| Profile | Partition | L2FIB | L2ACL | IPv4FIB | IPv4ACL | IPv4Flow | EgL2ACL | EgIPv4ACL | Reserved | IPv6FIB | IPv6ACL | IPv6Flow | EgIPv6ACL |
|-----------------|-----------|-------|-------|---------|---------|----------|---------|-----------|----------|---------|---------|----------|-----------|
| Default | | 32K | 2K | 256K | 12K | 24K | 1K | 1K | 8K | 0 | 0 | 0 | 0 |
| eg-default | | 32K | 2K | 512K | 12K | 24K | 1K | 1K | 8K | 32K | 3K | 4K | 1K |
| ipv4-320k | | 32K | 2K | 320K | 12K | 12K | 1K | 1K | 4K | 0 | 0 | 0 | 0 |
| pv4-egacl-16k | | 32K | 2K | 192K | 8K | 24K | 0 | 16K | 8K | 0 | 0 | 0 | 0 |
| ipv6-extacl | | 32K | 2K | 192K | 12K | 8K | 1K | 1K | 2K | 6K | 3K | 4K | 2K |
| l2-ipv4-inacl | | 32K | 33K | 64K | 27K | 8K | 2K | 2K | 2K | 0 | 0 | 0 | 0 |
| unified-default | | 32K | 3K | 192K | 9K | 8K | 2K | 2K | 2K | 6K | 2K | 4K | 2K |
| ipv4-64k-ipv6 | | 32K | 2K | 64K | 12K | 24K | 1K | 1K | 8K | 16K | 3K | 4K | 1K |

Microcode

Microcode is a compiled set of instructions for a CPU. On Dell Force10 systems, the microcode controls how packets are handled.

There is a default microcode, and several other microcodes are available, so that you can adjust packet handling according to your application. Specifying a microcode is mandatory when selecting a CAM profile (though you are not required to change it).



Note: Not all CAM profiles and microcodes are available for all systems. Refer to the Command Line Interface Reference Guide for details regarding available profiles for each system.

Table 11-3. Microcode Descriptions

| Microcode | Description |
|----------------|--|
| default | Distributes CAM space for a typical deployment |
| lag-hash-align | For applications that require the same hashing for bi-directional traffic (for example, VoIP call or P2P file sharing). For port-channels, this microcode maps both directions of a bi-directional flow to the same output link. |
| lag-hash-mpls | For hashing based on MPLS labels (up to five labels deep). With the default microcode, MPLS packets are distributed over a port-channel based on the MAC source and destination address. With the lag-hash-mpls microcode, MPLS packets are distributed across the port-channel based on IP source and destination address and IP protocol. This is applicable for MPLS packets with up to five labels. When the IP header is not available after the 5th label, hashing for default load-balance is based on MPLS labels. For packets with more than 5 labels, hashing is always based on the MAC source and destination address. |
| ipv6-extacl | Use this microcode when IPv6 is enabled. |
| acl-group | For applications that need 16k egress IPv4 ACLs (for example, the VLAN ACL Group feature, which permits group VLANs IP egress ACLs). |

CAM Profiling for ACLs

CAM Profiling for ACLs is supported on platform **E t** only.

The default CAM profile has 1K Layer 2 ingress ACL entries. If you need more memory for Layer 2 ingress ACLs, select the profile *l2-ipv4-inacl*.

When budgeting your CAM allocations for ACLs and QoS configurations, remember that ACL and QoS rules might consume more than one CAM entry depending on complexity. For example, TCP and UDP rules with port range options might require more than one CAM entry.

The Layer 2 ACL CAM partition has sub-partitions for several types of information. [Table 11-4](#) lists the sub-partition and the percentage of the Layer 2 ACL CAM partition that FTOS allocates to each by default.

Table 11-4. Layer 2 ACL CAM Sub-partition Sizes

| Partition | % Allocated |
|-----------|-------------|
| Sysflow | 6 |

Table 11-4. Layer 2 ACL CAM Sub-partition Sizes

| Partition | % Allocated |
|-----------|-------------|
| L2ACL | 14 |
| PVST | 50 |
| QoS | 12 |
| L2PT | 13 |
| FRRP | 5 |

You can re-configure the amount of space, in percentage, allocated to each sub-partition. As with the IPv4Flow partition, you can configure the Layer 2 ACL partition from EXEC Privilege mode or CONFIGURATION mode.

The amount of space that you can distribute to the sub-partitions is equal to the amount of CAM space that the selected CAM profile allocates to the Layer 2 ACL partition. FTOS requires that you specify the amount of CAM space for all sub-partitions and that the sum of all sub-partitions is 100%. FTOS displays the following message if the total allocated space is not correct:

```
% Error: Sum of all regions does not total to 100%.
```

Boot Behavior

The profile and microcode loaded on the primary RPM determines the profile and microcode that is required on all other chassis components and is called the “chassis profile.” A profile mismatch condition exists if either the CAM profile or the microcode does not match. The following points describe line card boot behavior when the line card profile does not match the chassis profile.

- A microcode mismatch constitutes a profile mismatch.
- When the line card profile and chassis profile are of the same type (single-CAM or dual-CAM), but their CAM profiles do not match, the line card must load a new profile and therefore takes longer to come online.
- If you insert a single-CAM line card into a chassis with a dual-CAM profile, the system displays [Message 1](#). The line card boots with the default (single-CAM) profile and remains in a problem state as shown in the following command output example. The line card cannot forward traffic in a problem state.

- If you insert a dual-CAM line card into a chassis with a single-CAM profile, the line card boots with a matching profile, but operates with a lower capability.

Message 1 EF Line Card with EG Chassis Profile Error

```
# Before reload:
01:09:56: %RPM0-P:CP %CHMGR-4-EG_PROFILE_WARN: If EG CAM profile is selected, non-EG
cards will be in problem state after reload
# After reload:
00:04:46: %RPM0-P:CP %CHMGR-3-PROFILE_MISMATCH: Mismatch: line card 1 has mismatch CAM
profile or microcode
```

Message 2 EH Line Card with EG Chassis Profile Error

```
# Before reload:
01:09:56: %RPM0-P:CP %CHMGR-4-EH_PROFILE_WARN: If EH CAM profile is selected, non-EJ
cards will be in problem state after reload
# After reload:
00:04:46: %RPM0-P:CP %CHMGR-3-PROFILE_MISMATCH: Mismatch: line card 1 has mismatch CAM
profile or microcode
```

Example: EF Line Card with EG Chassis Profile (Card Problem)

```
R1#show linecard 1 brief
```

```
-- Line card 1 --
Status          : card problem - mismatch cam profile
Next Boot       : online
Required Type   : E48TF - 48-port 10/100/1000Base-T line card with RJ-45 interfaces (EF)
Current Type    : E48TF - 48-port 10/100/1000Base-T line card with RJ-45 interfaces (EF)
Hardware Rev    : Base - 1.1  PP0 - 1.1  PP1 - 1.1
Num Ports       : 48
Up Time         : 0 sec
FTOS Version    : 7.6.1.0
Jumbo Capable   : yes
```

Example: EH Line Card with EG Chassis Profile (Card Problem)

```
R1#show linecard 1 brief
```

```
-- Line card 1 --
Status          : card problem - mismatch cam profile
Next Boot       : online
Required Type   : E90MH - 90-port 10/100/1000Base-T line card with mini RJ-21 interfaces (EH)
Current Type    : E90MH - 90-port 10/100/1000Base-T line card with mini RJ-21 interfaces (EH)
Hardware Rev    : Base - 0.3  PP0 - 1.1  PP1 -
Num Ports       : 90
Up Time         : 0 sec
FTOS Version    : 8.1.1.0
Jumbo Capable   : yes
```

When to Use CAM Profiling

The CAM profiling feature enables you to partition the CAM to best suit your application. For example:

- Configure more Layer 2 FIB entries when the system is deployed as a switch.
- Configure more Layer 3 FIB entries when the system is deployed as a router.
- Configure more ACLs (when IPv6 is not employed).
- Hash MPLS packets based on source and destination IP addresses for LAGs. Refer to [LAG Hashing](#).
- Hash based on bidirectional flow for LAGs. Refer to [LAG Hashing based on Bidirectional Flow](#).
- Optimize the VLAN ACL Group feature, which permits group VLANs for IP egress ACLs. Refer to [CAM profile for the VLAN ACL group feature](#).

Important Points to Remember

- CAM Profiling is available on the E-Series TeraScale with FTOS versions 6.3.1.1 and later.
- All line cards within a single system must have the same CAM profile; this profile must match the system CAM profile (the profile on the primary RPM).
 - FTOS automatically reconfigures the CAM profile on line cards and the secondary RPM to match the system CAM profile by saving the correct profile on the card and then rebooting it.
- The CAM configuration is applied to entire system when you use CONFIGURATION mode commands. You must save the running-configuration to affect the change.
- All CAM configuration commands require you to reboot the system.
- When budgeting your CAM allocations for ACLs and QoS configurations, remember that ACL and QoS rules might consume more than one CAM entry depending on complexity. For example, TCP and UDP rules with port range options might require more than one CAM entry. Refer to [Pre-calculating Available QoS CAM Space](#).
- After you install a secondary RPM, copy the running-configuration to the startup-configuration so that the new RPM has the correct CAM profile.

Differences Between EtherScale and TeraScale

- Only one CAM profile and microcode is available on EtherScale systems.
- Only EtherScale systems can sub-partition the IPv4ACL partition.
- Both EtherScale and TeraScale systems can sub-partition the IPv4Flow CAM partition.

Select CAM Profiles

A CAM profile is selected in CONFIGURATION mode. The CAM profile is applied to entire system, however, you must save the running-configuration to affect the change.

All components in the chassis must have the same CAM profile and microcode. The profile and microcode loaded on the primary RPM determines the profile that is required on all other chassis components.

- If a newly installed line card has a profile different from the primary RPM, the card reboots so that it can load the proper profile.
- If a the standby RPM has a profile different from the primary RPM, the card reboots so that it can load the proper profile.

To change the CAM profile on the entire system:

| Step | Task | Command Syntax | Command Mode |
|------|--|--|----------------|
| 1 | Select a CAM profile. | <code>cam-profile <i>profile</i> microcode <i>microcode</i></code> | CONFIGURATION |
| 2 | Save the running-configuration. | <code>copy running-config startup-config</code> | EXEC Privilege |
| 3 | Verify that the new CAM profile will be written to the CAM on the next boot. | <code>show cam-profile summary</code> | EXEC Privilege |
| 4 | Reload the system. | <code>reload</code> | EXEC Privilege |

CAM Allocation

User Configurable CAM Allocations is available on platforms: C S **S4810** **S4820T**

Allocate space for IPV4 ACLs and QoS regions, and IPv6 6 ACLs and QoS regions on the C-Series and S-Series by using the `cam-acl` command in CONFIGURATION mode.

The CAM space is allotted in FP blocks. The total space allocated must equal 13 FP blocks. Note that there are 16 FP blocks, but the System Flow requires 3 blocks that cannot be reallocated. The default CAM Allocation settings are:

- L3 ACL (`ipv4acl`): 6
- L2 ACL (`l2acl`): 5
- IPv6 L3 ACL (`ipv6acl`): 0
- L3 QoS (`ipv4qos`): 1
- L2 QoS (`l2qos`): 1
- L2PT (`l2pt`): 1
- MAC ACLs (`ipmacacl`): 2

- ECFMACL (ecfmacl): 0
- VMAN QoS (vman-qos): 0
- VMAN Dual QoS (vman-dual-qos): 0

The following additional CAM Allocation settings are supported on the **S4810** : and **S4820T**

- FCoE ACL (fcoeacl): 0
- ISCSI Opt ACL (iscsiptacl): 2

The ipv6acl and vman-dual-qos allocations must be entered as a factor of 2 (2, 4, 6, 8, 10). All other profile allocations can use either even or odd numbered ranges.



Note: On the S4810 and S4820T, there can be *only one* odd number of Blocks in the CLI configuration; the other Blocks must be in factors of 2. For example, a CLI configuration of 5+4+2+1+1 Blocks is not supported; a configuration of 6+4+2+1 Blocks is supported.

You must save the new CAM settings to the startup-config (write-mem or copy run start) then reload the system for the new settings to take effect.

To configure the IPv4 and IPv6 ACLs and QoS regions on the entire system:

| Step | Task | Command Syntax | Command Mode |
|------|--|---|----------------|
| 1 | Select a cam-acl action | cam-acl [default l2acl] | CONFIGURATION |
| | Note: Selecting default resets the CAM entries to the default settings. Select l2acl to allocate space for the ACLs, and QoS regions. | | |
| 2 | Enter the number of FP blocks for each region. Note: If allocation values are not entered for the CAM regions, the value is 0. | l2acl <i>number</i> ipv4acl <i>number</i> ipv6acl <i>number</i> , ipv4qos <i>number</i> l2qos <i>number</i> , l2pt <i>number</i> ipmacacl <i>number</i> ecfmacl <i>number</i> [vman-qos vman-dual-qos <i>number</i>] | EXEC Privilege |
| 3 | Verify that the new settings will be written to the CAM on the next boot. | show cam-acl | EXEC Privilege |
| 4 | Reload the system. | reload | EXEC Privilege |

Test CAM Usage

The test cam-usage command is supported on platforms **C e S**

This command applies to both IPv4 and IPv6 CAM profiles, but is best used when verifying QoS optimization for IPv6 ACLs.

Use this command to determine whether sufficient ACL CAM space is available to enable a service-policy. Create a Class Map with all required ACL rules, then execute the `test cam-usage` command in Privilege mode to verify the actual CAM space required. The following example gives a sample of the output shown when executing the command. The status column indicates whether or not the policy can be enabled.

```
FTOS#test cam-usage service-policy input TestPolicy linecard all
```

| Linecard | Portpipe | CAM Partition | Available CAM | Estimated CAM per Port | Status |
|----------|----------|---------------|---------------|------------------------|---------|
| 2 | 1 | IPv4Flow | 232 | 0 | Allowed |
| 2 | 1 | IPv6Flow | 0 | 0 | Allowed |
| 4 | 0 | IPv4Flow | 232 | 0 | Allowed |
| 4 | 0 | IPv6Flow | 0 | 0 | Allowed |

```
FTOS#
```

View CAM Profiles

View the current CAM profile for the chassis and each component using the command `show cam-profile`, as shown in the following example. This command also shows the profile that will be loaded upon the next chassis or component reload.

```
FTOS#show cam-profile
```

```
-- Chassis CAM Profile --
```

```
CamSize           : 18-Meg
                  : Current Settings : Next Boot
Profile Name      : Default           : Default
L2FIB             : 32K entries       : 32K entries
L2ACL             : 1K entries         : 1K entries
IPv4FIB           : 256K entries      : 256K entries
IPv4ACL           : 12K entries        : 12K entries
IPv4Flow          : 24K entries        : 24K entries
EgL2ACL           : 1K entries         : 1K entries
EgIPv4ACL         : 1K entries         : 1K entries
Reserved          : 8K entries         : 8K entries
FIB               : 0 entries          : 0 entries
ACL               : 0 entries          : 0 entries
Flow              : 0 entries          : 0 entries
EgACL             : 0 entries          : 0 entries
MicroCode Name    : Default           : Default
--More--
```

View a brief output of the command `show cam-profile` using the summary option.

The command `show running-config cam-profile` shows the current profile and microcode as shown in the following example.



Note: If you select the CAM profile from CONFIGURATION mode, the output of this command does not reflect any changes until you save the running-configuration and reload the chassis.

```

FTOS#show running-config cam-profile
!
cam-profile default microcode default

FTOS#

```

View CAM-ACL settings

The show cam-acl command is supported on platforms **C S** **S4810** **S4820T**

View the current cam-acl settings for the C-Series, S-Series and systems chassis and each component using the command show cam-acl, as shown in as shown in the following examples.

The default values for the show cam-acl command for C-Series and S-Series are:

```

FTOS# show cam-acl

-- Chassis Cam ACL --
      Current Settings(in block sizes)
L2Acl      :      2
Ipv4Acl    :      2
Ipv6Acl    :      2
Ipv4Qos    :      2
L2Qos     :      2
L2PT      :      1
IpMacAcl  :      2
VmanQos   :      0
VmanDualQos :    0
EcfmAcl   :      0

-- Line card 0 --
      Current Settings(in block sizes)
L2Acl      :      2
Ipv4Acl    :      2
Ipv6Acl    :      2
Ipv4Qos    :      2
L2Qos     :      2
L2PT      :      1
IpMacAcl  :      2
VmanQos   :      0
VmanDualQos :    0
EcfmAcl   :      0

-- Line card 6 --
      Current Settings(in block sizes)
L2Acl      :      2
Ipv4Acl    :      2
Ipv6Acl    :      2
Ipv4Qos    :      2
L2Qos     :      2
L2PT      :      1
IpMacAcl  :      2
VmanQos   :      0
VmanDualQos :    0
EcfmAcl   :      0

```

The default values for the show cam-acl command for the **S4810** and **S4820T** are:

```
FTOS#show cam-acl

-- Chassis Cam ACL --
                Current Settings(in block sizes)
L2Acl           :           4
Ipv4Acl         :           4
Ipv6Acl         :           0
Ipv4Qos         :           2
L2Qos           :           1
L2PT            :           0
IpMacAcl        :           0
VmanQos         :           0
VmanDualQos     :           0
EcfmAcl         :           0
FcoeAcl         :           0
iscsiOptAcl     :           2

-- Stack unit 0 --
                Current Settings(in block sizes)
L2Acl           :           4
Ipv4Acl         :           4
Ipv6Acl         :           0
Ipv4Qos         :           2
L2Qos           :           1
L2PT            :           0
IpMacAcl        :           0
VmanQos         :           0
VmanDualQos     :           0
EcfmAcl         :           0
FcoeAcl         :           0
iscsiOptAcl     :           2

FTOS#
```

View CAM Usage

View the amount of CAM space available, used, and remaining in each partition (including IPv4Flow and Layer 2 ACL sub-partitions) using the command show cam-usage from EXEC Privilege mode, as shown in the following example.

```
R1#show cam-usage
Linecard|Portpipe| CAM Partition | Total CAM | Used CAM | Available CAM
=====|=====|=====|=====|=====|=====
      1 |    0 | IN-L2 ACL |    1008 |    320 |    688
      |    | IN-L2 FIB |   32768 |   1132 |   31636
      |    | IN-L3 ACL |   12288 |     2 |   12286
      |    | IN-L3 FIB |  262141 |    14 |  262127
      |    | IN-L3-SysFlow |    2878 |    45 |    2833
```

| | | | | | |
|---|---|----------------|--------|------|--------|
| | | IN-L3-TrcList | 1024 | 0 | 1024 |
| | | IN-L3-McastFib | 9215 | 0 | 9215 |
| | | IN-L3-Qos | 8192 | 0 | 8192 |
| | | IN-L3-PBR | 1024 | 0 | 1024 |
| | | IN-V6 ACL | 0 | 0 | 0 |
| | | IN-V6 FIB | 0 | 0 | 0 |
| | | IN-V6-SysFlow | 0 | 0 | 0 |
| | | IN-V6-McastFib | 0 | 0 | 0 |
| | | OUT-L2 ACL | 1024 | 0 | 1024 |
| | | OUT-L3 ACL | 1024 | 0 | 1024 |
| | | OUT-V6 ACL | 0 | 0 | 0 |
| 1 | 1 | IN-L2 ACL | 320 | 0 | 320 |
| | | IN-L2 FIB | 32768 | 1136 | 31632 |
| | | IN-L3 ACL | 12288 | 2 | 12286 |
| | | IN-L3 FIB | 262141 | 14 | 262127 |
| | | IN-L3-SysFlow | 2878 | 44 | 2834 |

--More--

Configure IPv4Flow Sub-partitions

IPv4Flow sub-partition are supported on platform E

The IPv4Flow CAM partitions have sub-partitions for several types of information. [Table 11-5](#) lists the types of information stored in this partition and the number of entries that FTOS allocates to each type.

Table 11-5. IPv4Flow CAM Sub-partition Sizes

| Partition | Space Allocated (EtherScale) | Space Allocated (TeraScale) | Space Allocated (ExaScale) |
|-------------------|------------------------------|-----------------------------|----------------------------|
| ACL | 8K | — | — |
| Multicast FIB/ACL | 9K | 3K | 3K |
| PBR | 1K | 1K | 1K |
| QoS | 8K | 2K | 2K |
| System Flow | 5K | 5K | 5K |
| Trace Lists | 1 | 1K | 1K |

You can re-configure the amount of space allocated for each type of entry. FTOS requires that you specify an amount of CAM space for all types and in the order shown in [Table 11-5](#).

- The IPv4Flow configuration is applied to entire system when you enter the command `cam-ipv4flow` from CONFIGURATION mode, however, you must save the running-configuration to affect the change.

The amount of space that is allocated among the sub-partitions must be equal to the amount of CAM space allocated to IPv4Flow by the selected CAM profile (refer to [Table 11-1](#)); **Message 3** is displayed if the total allocated space is not correct.

Message 3 IPv4Flow Configuration Error

```
% Error: Total size must add up to match IPv4flow size of 24K required by the
configured profile.
```

The minimum amount of space that can be allocated to any sub-partition is 1K, except for System flow, for which the minimum is 4K.

To re-allocate CAM space within the IPv4Flow partition on the entire system:

| Step | Task | Command Syntax | Command Mode |
|------|--|------------------------------------|----------------|
| 1 | Re-allocate CAM space within the IPv4Flow partition. | cam-ipv4flow | CONFIGURATION |
| 2 | Save the running-configuration. | copy running-config startup-config | EXEC Privilege |
| 3 | Verify that the new CAM configuration will be written to the CAM on the next boot. | show cam-ipv4flow | EXEC Privilege |
| 4 | Reload the system. | reload | EXEC Privilege |

```
FTOS(conf)#cam-ipv4flow default
FTOS#copy running-config startup-config
File with same name already exist.
Proceed to copy the file [confirm yes/no]: yes
!
3914 bytes successfully copied

FTOS#sh cam-ipv4flow
-- Chassis Cam Ipv4Flow --
                Current Settings  Next Boot
Multicast Fib/Acl : 8K             9K
Pbr               : 2K             1K
Qos               : 7K             8K
System Flow      : 6K             5K
Trace Lists      : 1K             1K

-- Line card 0 --
                Current Settings  Next Boot
Multicast Fib/Acl : 8K             9K
Pbr               : 2K             1K
Qos               : 7K             8K
System Flow      : 6K             5K
Trace Lists      : 1K             1K

-- Line card 1 --
                Current Settings  Next Boot
Multicast Fib/Acl : 8K             9K
```

| | | | |
|-------------|---|----|----|
| Ebr | : | 2K | 1K |
| Qos | : | 7K | 8K |
| System Flow | : | 6K | 5K |
| Trace Lists | : | 1K | 1K |

Configure Ingress Layer 2 ACL Sub-partitions

IPv4Flow sub-partitions are supported on platform 

The Ingress Layer 2 ACL CAM partition has sub-partitions for several types of information. [Table 11-6](#) lists the sub-partition and the percentage of the Ingress Layer 2 ACL CAM partition that FTOS allocates to each by default.

Table 11-6. Layer 2 ACL CAM Sub-partition Sizes

| Partition | % Allocated |
|-----------|-------------|
| Sysflow | 6 |
| L2ACL | 14 |
| *PVST | 50 |
| QoS | 12 |
| L2PT | 13 |
| FRRP | 5 |

You can re-configure the amount of space, in percentage, allocated to each sub-partition.

- Apply the Ingress Layer 2 ACL configuration to entire system by entering the command `cam-l2acl` from CONFIGURATION mode, however, you must save the running-configuration to affect the change.

The amount of space that you can distribute to the sub-partitions is equal to the amount of CAM space that the selected CAM profile allocates to the Ingress Layer 2 ACL partition (refer to [Table 11-1](#)). FTOS requires that you specify the amount of CAM space for all sub-partitions and that the sum of all sub-partitions is 100%. FTOS displays message [Message 4](#) if the total allocated space is not correct.

Message 4 Layer 2 ACL Configuration Error

% Error: Sum of all regions does not total to 100%.



Note: You must allocate at least (*<number of VLANs> * <Number of switching ports per port-pipe>*) entries at least when employing PVST+ . For example, the default CAM Profile allocates 1000 entries to the Ingress Layer 2 ACL CAM region, and a 48-port linecard has two port-pipes with 24 ports each. If you have 5 VLANs, then you must allocate at least 120 (5*24) entries to the PVST Ingress Layer 2 ACL CAM region, which is 12% of the total 1000 available entries.

To re-allocate CAM space within the Ingress Layer 2 ACL partition on the entire system as shown in the following example. :

| Step | Task | Command Syntax | Command Mode |
|------|--|------------------------------------|----------------|
| 1 | Re-allocate CAM space within the Ingress Layer 2 ACL partition. | cam-l2acl | CONFIGURATION |
| 2 | Save the running-configuration. | copy running-config startup-config | EXEC Privilege |
| 3 | Verify that FTOS will write the new CAM configuration to the CAM on the next boot. | show cam-l2acl | EXEC Privilege |
| 4 | Reload the system. | reload | EXEC Privilege |

```
FTOS(conf)#do show cam-l2acl | find "Line card 1"
-- Line card 1 --
```

```
      Current Settings(in percent)
Sysflow  :      6
L2Acl    :     14
Pvst     :     50
Qos      :     12
L2pt     :     13
Frrp     :      5
```

[output omitted]

```
FTOS(conf)#cam-l2acl system-flow 100 l2acl 0 p 0 q 0 l 0 f 0
FTOS(conf)#do show cam-l2acl | find "Line card 1"
-- Line card 1 --
```

```
      Current Settings(in percent)
Sysflow  :      6
L2Acl    :     14
Pvst     :     50
Qos      :     12
L2pt     :     13
Frrp     :      5
```

[output omitted]

```
FTOS(conf)#do copy run start
File with same name already exist.
Proceed to copy the file [confirm yes/no]: yes
!
```

```
8676 bytes successfully copied
02:00:49: %RPM0-P:CP %FILEMGR-5-FILESAVED: Copied running-config to startup-config in flash by default
FTOS(conf)#do show cam-l2acl | find "Line card 1"
-- Line card 1 --
```

```
      Current Settings(in percent)  Next Boot(in percent)
Sysflow  :      6                    100
L2Acl    :     14                    5
Pvst     :     50                    5
Qos      :     12                    5
L2pt     :     13                    5
Frrp     :      5                    5
```

Return to the Default CAM Configuration

Return to the default CAM Profile, microcode, IPv4Flow, or Layer 2 ACL configuration using the keyword `default` from EXEC Privilege mode or from CONFIGURATION mode, as shown in the following example.

```
FTOS (conf)#cam-profile ?
default          Enable default CAM profile
eg-default        Enable eg-default CAM profile
ipv4-320k         Enable 320K CAM profile
ipv4-egacl-16k   Enable CAM profile with 16K IPv4 egress ACL
ipv6-extacl       Enable CAM profile with extended ACL
l2-ipv4-inacl     Enable CAM profile with 32K L2 and 28K IPv4 ingress ACL
unified-default   Enable default unified CAM profile
FTOS (conf)#cam-profile default microcode ?
default          Enable default microcode
lag-hash-align    Enable microcode with LAG hash align
lag-hash-mpls     Enable microcode with LAG hash MPLS
FTOS (conf)#cam-profile default microcode default
FTOS (conf)#cam-ipv4flow ?
default          Reset IPv4flow CAM entries to default setting
multicast-fib     Set multicast FIB entries
FTOS (conf)#cam-l2acl ?
default          Reset L2-ACL CAM entries to default setting
system-flow       Set system flow entries
```

CAM Optimization

[CAM optimization](#) is supported on platforms **C S**

When this command is enabled, if a Policy Map containing classification rules (ACL and/or dscp/ip-precedence rules) is applied to more than one physical interface on the same port-pipe, only a single copy of the policy is written (only 1 FP entry will be used). When the command is disabled, the system behaves as described in this chapter.

Applications for CAM Profiling

LAG Hashing

FTOS includes a CAM profile and microcode that treats MPLS packets as non-IP packets. Normally, switching and LAG hashing is based on source and destination MAC addresses. Alternatively, you can base LAG hashing for MPLS packets on source and destination IP addresses. This type of hashing is allowed for MPLS packets with 5 labels or less.

MPLS packets are treated as follows:

- When MPLS IP packets are received, FTOS looks up to 5 labels deep for the IP header.
- When an IP header is present, hashing is based on IP 3 tuple (source IP address, destination IP address, and IP protocol).
- If an IP header is not found after the 5th label, hashing is based on the MPLS labels.
- If the packet has more than 5 MPLS labels, hashing is based on the source and destination MAC address.

To enable this type of hashing, use the default CAM profile with the microcode *lag-hash-mpls*.

LAG Hashing based on Bidirectional Flow

To hash LAG packets such that both directions of a bidirectional flow (for example, VoIP or P2P file sharing) are mapped to the same output link in the LAG bundle, use the default CAM profile with the microcode *lag-hash-align*.

CAM profile for the VLAN ACL group feature

IPv4Flow sub-partitions are supported on platform E_t only.

To optimize for the VLAN ACL Group feature, which permits group VLANs for the IP egress ACL, use the CAM profile *ipv4-egacl-16k* with the default microcode.



Note: Do not use this CAM profile for Layer 2 egress ACLs.

Troubleshoot CAM Profiling

CAM Profile Mismatches

The CAM profile on all cards must match the system profile. In most cases, the system corrects mismatches by copying the correct profile to the card, and rebooting the card. If three resets do not bring up the card, or if the system is running an FTOS version prior to 6.3.1.1, the system presents an error message. In this case, manually adjust the CAM configuration on the card to match the system configuration.

Dell Force10 recommends the following to prevent mismatches:

- Use the eg-default CAM profile in a chassis that has only EG Series line cards. If this profile is used in a chassis with non-EG line cards, the non-EG line cards enter a problem state.
- Before moving a card to a new chassis, change the CAM profile on a card to match the new system profile.
- After installing a secondary RPM into a chassis, copy the running-configuration to the startup-configuration.

- Change to the default profile if downgrading to and FTOS version earlier than 6.3.1.1.
- Use the CONFIGURATION mode commands so that the profile is change throughout the system.
- Use the EXEC Privilege mode commands to match the profile of a component to the profile of the target system.

QoS CAM Region Limitation

The default CAM profile allocates a partition within the IPv4Flow region to store QoS service policies. If the QoS CAM space is exceeded, messages similar to the ones in [Message 5](#) are displayed.

Message 5 QoS CAM Region Exceeded

```
%EX2YD:12 %DIFFSERV-2-DSA_QOS_CAM_INSTALL_FAILED: Not enough space in L3
Cam(PolicyQos) for class 2 (Gi 12/20) entries on portpipe 1 for linecard 12
%EX2YD:12 %DIFFSERV-2-
DSA_QOS_CAM_INSTALL_FAILED: Not enough space in L3 Cam(PolicyQos) for class 5 (Gi 12/
22) entries on portpipe 1 for linecard 12
```

If you exceed the QoS CAM space:

| Step | Task |
|------|---|
| 1 | Verify that you have configured a CAM profile that allocates 24K entries to the IPv4 system flow region. Refer to View CAM Profiles . |
| 2 | Allocate more entries in the IPv4Flow region to QoS. Refer to Configure IPv4Flow Sub-partitions . |

FTOS version 7.4.1 introduced the ability to view the actual CAM usage before applying a service-policy. The command `test cam-usage service-policy` provides this test framework, refer to [Pre-calculating Available QoS CAM Space](#).



Note: For troubleshooting other CAM issues, refer to the *E-Series Network Operations Guide*.

Control Plane Policing (CoPP)

Control Plane Policing (CoPP) is supported on platform: **S4810** and **S4820T**

Overview

Control Plane Policing (CoPP) uses ACL rules and QoS policies to create filters for a system's control plane. That filter prevents traffic not specifically identified as legitimate from reaching the system control plane, rate-limits, traffic to an acceptable level.

Control Plane Policing (CoPP) increases security on the system by protecting the Routing Processor from unnecessary or DoS traffic, giving priority to important control plane and management traffic. CoPP uses a dedicated control plane configuration through the ACL and QoS CLIs to provide filtering and rate-limiting capabilities for the control plane packets.

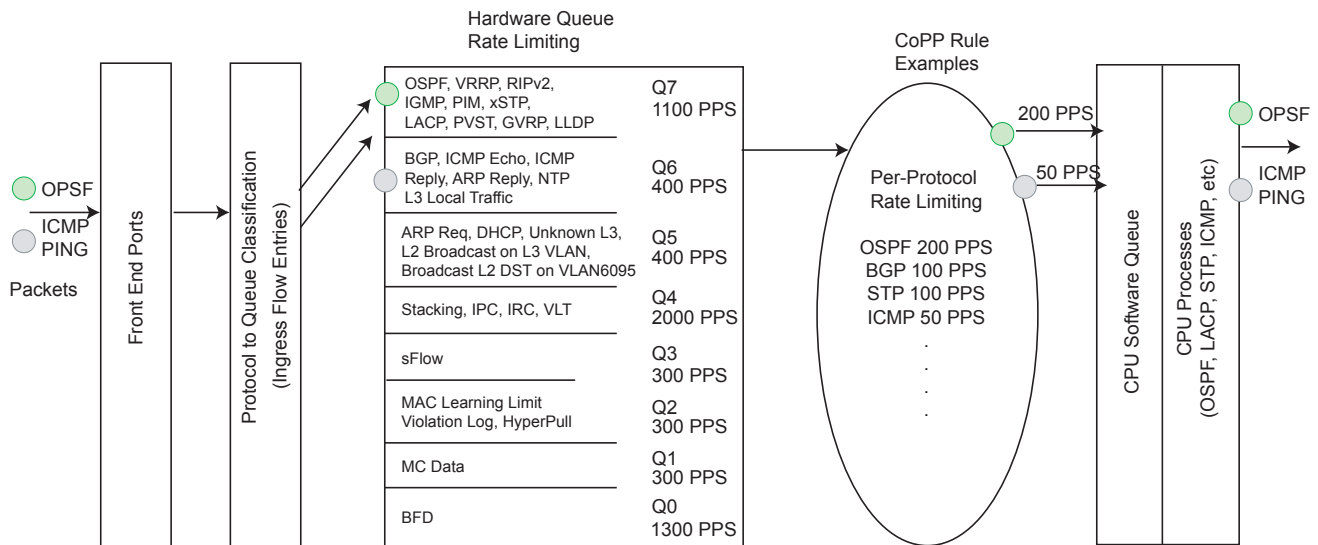

The following illustration shows an example of the difference between having CoPP implemented and not having CoPP implemented.

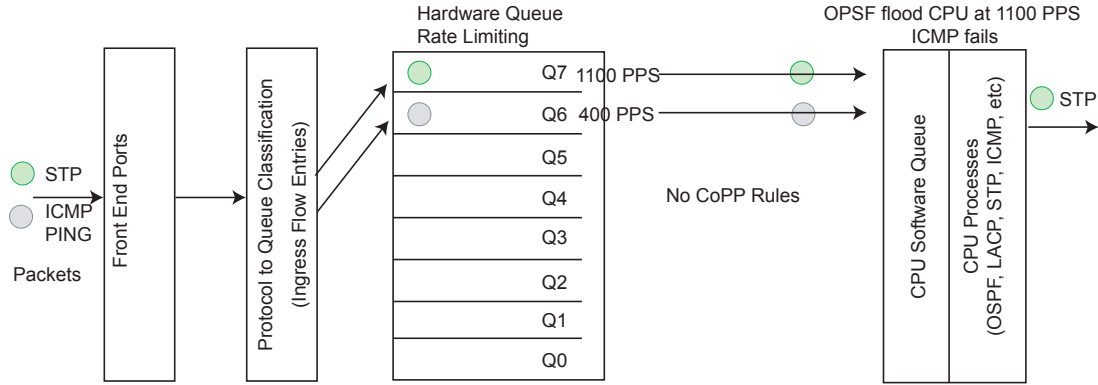

Q7 receives STP at 1100 pps due to network storm/loop. The CPU is hit with the entire 1100 pps and the PING attempt fails intermittently.

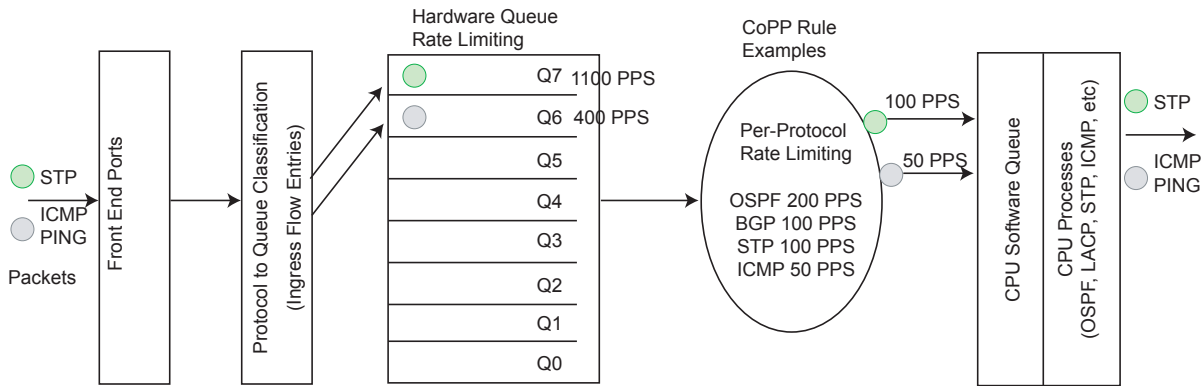

CoPP restricts the STP control packet rate to the CPU to 100 pps. PING works reliably.

Configure Control Plane Policing

The S4810 and S4820T can process a maximum of 6800 PPS (packets per second). Protocols that share a single queue may experience flaps if one of the protocols receives a high rate of control traffic even though Per Protocol CoPP is applied. This happens because Queue-Based Rate Limiting is applied first.

For example, BGP and ICMP share same queue (Q6); Q6 has 400 PPS of bandwidth by default. The desired rate of ICMP is 100 pps and the remaining 300 pps is assigned to BGP. If ICMP packets come at 400 pps, BGP packets may be dropped though ICMP packets are rate-limited to 100 PPS. This may be solved by increasing Q6 bandwidth to 700 pps to allow both ICMP and BGP packets and then applying per-flow CoPP for ICMP and BGP packets. The setting of this Q6 bandwidth is purely dependent on the incoming traffic for the set of protocols sharing the same queue. If the user is not aware of the incoming protocol traffic rate then the required Queue Rate Limit value cannot be set. Such queue bandwidth tuning must be done carefully because the system cannot open up to handle any rate, including traffic coming at the line rate.

CoPP policies are assigned on a per-protocol or a per-queue basis, and are assigned in CONTROL-PLANE mode to each port-pipe.

The CoPP policies are configured by creating extended ACL rules and specifying rate-limits through QoS policies. The ACLs and QoS policies are assigned as service-policies.

Configure CoPP for protocols

This section lists the commands necessary to create and enable the service-policies for CoPP. Refer to [Access Control Lists \(ACLs\)](#) and [Quality of Service \(QoS\)](#) for complete information about creating ACLs and QoS rules.

The basics for creating a CoPP service policy is to create a Layer 2, Layer 3, and/or an IPv6 ACL rule for the desired protocol type. Then, create a QoS input policy to rate-limit the protocol traffics according to the ACL. The ACL and QoS policies are finally assigned to a control-plane service policy for each port-pipe.

| Step | Task | Command Syntax | Command Mode |
|------|---|--|---------------|
| 1 | Create a Layer 2 extended ACL for control-plane traffic policing for a particular protocol. | mac access-list extended <i>name</i> cpu-qos permit {arp frpp gvrp isis lacp lldp stp} | CONFIGURATION |
| 2 | Create a Layer 3 extended ACL for control-plane traffic policing for a particular protocol. | ip access-list extended <i>name</i> cpu-qos permit {bgp dhcp dhcp-relay ftp icmp igmp msdp ntp ospf pim ip ssh telnet vrrp} | CONFIGURATION |
| 3 | Create an IPv6 ACL for control-plane traffic policing for a particular protocol. | ipv6 aqccess-list <i>name</i> cpu-qos permit {bgp icmp vrrp} | CONFIGURATION |
| 4 | Create a QoS input policy for the router and assign the policing. | qos-policy-input <i>name</i> cpu-qos rate-police | CONFIGURATION |
| 5 | Create a QoS class map to differentiate the control-plane traffic and assign to an ACL. | class-map match-any <i>name</i> cpu-qos match {ip mac ipv6} access-group <i>name</i> | CONFIGURATION |
| 6 | Create a QoS input policy map to match to the class-map and qos-policy for each desired protocol. | policy-map-input <i>name</i> cpu-qos class-map <i>name</i> qos-policy <i>name</i> | CONFIGURATION |
| 7 | Enter Control Plane mode. | control-plane-cpuqos | CONFIGURATION |
| 8 | Assign the protocol based service policy on the control plane. Enabling this command on a port-pipe automatically enables the ACL and QoS rules creates with the cpu-qos keyword. | service-policy rate-limit-protocols | CONTROL-PLANE |

Sample Config for CoPP protocol configuration

Create IP/IPv6/MAC Extended ACL

```
FTOS(conf)#ip access-list extended ospf cpu-qos
FTOS(conf-ip-acl-cpuqos)#permit ospf
FTOS(conf-ip-acl-cpuqos)#exit
```

```
FTOS(conf)#ip access-list extended bgp cpu-qos
FTOS(conf-ip-acl-cpuqos)#permit bgp
FTOS(conf-ip-acl-cpuqos)#exit
```

```
FTOS(conf)#mac access-list extended lacp cpu-qos
FTOS(conf-mac-acl-cpuqos)#permit lacp
FTOS(conf-mac-acl-cpuqos)#exit
```

```
FTOS(conf)#ipv6 access-list ipv6-icmp cpu-qos
FTOS(conf-ipv6-acl-cpuqos)#permit icmp
FTOS(conf-ipv6-acl-cpuqos)#exit
```

```
FTOS(conf)#ipv6 access-list ipv6-vrrp cpu-qos
FTOS(conf-ipv6-acl-cpuqos)#permit vrrp
FTOS(conf-ipv6-acl-cpuqos)#exit
```

Create QoS Input Policy

```
FTOS(conf)#qos-policy-in rate_limit_200k cpu-qos
FTOS(conf-in-qos-policy-cpuqos)#rate-police 200 40 peak 500 40
FTOS(conf-in-qos-policy-cpuqos)#exit
```

```
FTOS(conf)#qos-policy-in rate_limit_400k cpu-qos
FTOS(conf-in-qos-policy-cpuqos)#rate-police 400 50 peak 600 50
FTOS(conf-in-qos-policy-cpuqos)#exit
```

```
FTOS(conf)#qos-policy-in rate_limit_500k cpu-qos
FTOS(conf-in-qos-policy-cpuqos)#rate-police 500 50 peak 1000 50
FTOS(conf-in-qos-policy-cpuqos)#exit
```

Create QoS Class Map

```
FTOS(conf)#class-map match-any class_ospf cpu-qos
FTOS(conf-class-map-cpuqos)#match ip access-group ospf
FTOS(conf-class-map-cpuqos)#exit
```

```
FTOS(conf)#class-map match-any class_bgp cpu-qos
FTOS(conf-class-map-cpuqos)#match ip access-group bgp
FTOS(conf-class-map-cpuqos)#exit
```

```
FTOS(conf)#class-map match-any class_lacp cpu-qos
FTOS(conf-class-map-cpuqos)#match mac access-group lacp
FTOS(conf-class-map-cpuqos)#exit
```

```
FTOS(conf)#class-map match-any class-ipv6-icmp cpu-qos
FTOS(conf-class-map-cpuqos)#match ipv6 access-group ipv6-icmp
FTOS(conf-class-map-cpuqos)#exit
```

Match QoS Class Map to QoS Policy

```
FTOS(conf)#policy-map-input egressFP_rate_policy cpu-qos
FTOS(conf-policy-map-in-cpuqos)#class-map class_ospf qos-policy rate_limit_500k
FTOS(conf-policy-map-in-cpuqos)#class-map class_bgp qos-policy rate_limit_400k
FTOS(conf-policy-map-in-cpuqos)#class-map class_lacp qos-policy rate_limit_200k
FTOS(conf-policy-map-in-cpuqos)#class-map class-ipv6 qos-policy rate_limit_200k
FTOS(conf-policy-map-in-cpuqos)#exit
```

Create Control Plane Service Policy

```
FTOS(conf)#control-plane-cpuqos
FTOS(conf-control-cpuqos)#service-policy rate-limit-protocols egressFP_rate_policy
FTOS(conf-control-cpuqos)#exit
```

Configure CoPP for CPU queues

Controlling traffic on the CPU queues does not require ACL rules, but does require QoS policies.

CoPP for CPU queues converts the input rate from **kbps** to **pps**, assuming 64 bytes is the average packet size, and applies that rate to the corresponding queue. Consequently, 1 kbps is roughly equivalent to 2 pps.

The basics for creating a CoPP service policy is to create QoS policies for the desired CPU bound queue and associate it with a particular rate-limit. The QoS policies are assigned to a control-plane service policy for each port-pipe.

| Step | Task | Command Syntax | Command Mode |
|------|--|---|---------------|
| 1 | Create a QoS input policy for the router and assign the policing. | qos-policy-input <i>name</i> cpu-qos | CONFIGURATION |
| 2 | Create an input policy-map to assign the QoS policy to the desired service queues.1. | policy-map--input <i>name</i> cpu-qos service-queue 0 qos-policy <i>name</i> | CONFIGURATION |
| 3 | Enter Control Plane mode. | control-plane-cpuqos | CONFIGURATION |
| 4 | Assign a CPU queue-based service policy on the control plane in cpu-qos mode. Enabling this command sets the queue rates according to those configured. | service-policy rate-limit-cpu-queues <i>name</i> | CONTROL-PLANE |

Sample Config for CoPP CPU queue configuration

Create QoS Policy

```
FTOS#conf
FTOS(conf)#qos-policy-input cpuq_1
FTOS(conf-qos-policy-in)#rate-police 3000 40 peak 500 40
FTOS(conf-qos-policy-in)#exit
```

```

FTOS (conf)#qos-policy-input cpuq_2
FTOS (conf-qos-policy-in)#rate-police 5000 80 peak 600 50
FTOS (conf-qos-policy-in)#exit

```

Assign QoS Policy to Queues

```

FTOS (conf)#policy-map-input cpuq_rate_policy cpu-qos
FTOS (conf-qos-policy-in)#service-queue 5 qos-policy cpuq_1
FTOS (conf-qos-policy-in)#service-queue 6 qos-policy cpuq_2
FTOS (conf-qos-policy-in)#service-queue 7 qos-policy cpuq_1

```

Create Control Plane Service Policy

```

FTOS#conf
FTOS (conf)#control-plane
FTOS (conf-control-plane)#service-policy rate-limit-cpu-queues cpuq_rate_policy

```

Show commands

Use the **show cpu-queue rate cp** command to view the rates for each queue.

```

FTOS#show cpu-queue rate cp
Service-Queue          Rate (PPS)
-----
Q0                      1300
Q1                      300
Q2                      300
Q3                      300
Q4                      2000
Q5                      400
Q6                      400
Q7                      1100
FTOS#

```

Use the **show ip protocol-queue-mapping** command to view the queue mapping for each configured protocol.

```

FTOS#show ip protocol-queue-mapping
Protocol  Src-Port  Dst-Port  TcpFlag  Queue  EgPort  Rate (kbps)
-----
TCP (BGP)  any/179   179/any   _        Q6     CP       100
UDP (DHCP) 67/68     68/67    _        Q6/Q5  CP       _
UDP (DHCP-R) 67        67        _        Q6     CP       _
TCP (FTP)   any       21        _        Q6     CP       _
ICMP       any       any       _        Q6     CP       _
IGMP       any       any       _        Q7     CP       _
TCP (MSDP) any/639   639/any  _        Q6     CP       _
UDP (NTP)   any       123      _        Q6     CP       _
OSPF       any       any       _        Q7     CP       _
PIM        any       any       _        Q7     CP       _
UDP (RIP)   any       520      _        Q7     CP       _
TCP (SSH)   any       22        _        Q6     CP       _
TCP (TELNET) any       23        _        Q6     CP       _
VRRP       any       any       _        Q7     CP       _

```

FTOS#

Use the **show mac protocol-queue-mapping** command to view the queue mapping for the MAC protocols.

FTOS#**show mac protocol-queue-mapping**

| Protocol | Destination Mac | EtherType | Queue | EgPort | Rate (kbps) |
|----------|----------------------|-----------|-------|--------|-------------|
| ARP | any | 0x0806 | Q5/Q6 | CP | — |
| FRRP | 01:01:e8:00:00:10/11 | any | Q7 | CP | — |
| LACP | 01:80:c2:00:00:02 | 0x8809 | Q7 | CP | — |
| LLDP | any | 0x88cc | Q7 | CP | — |
| GVRP | 01:80:c2:00:00:21 | any | Q7 | CP | — |
| STP | 01:80:c2:00:00:00 | any | Q7 | CP | — |
| ISIS | 01:80:c2:00:00:14/15 | any | Q7 | CP | — |
| | 09:00:2b:00:00:04/05 | any | Q7 | CP | — |

FTOS#

Use the **show ipv6 protocol-queue-mapping** command to view the queue mapping for IPv6 protocols.

FTOS#**show ipv6 protocol-queue-mapping**

| Protocol | Src-Port | Dst-Port | TcpFlag | Queue | EgPort | Rate (kbps) |
|-----------|----------|----------|---------|-------|--------|-------------|
| TCP (BGP) | any/179 | 179/any | — | Q6 | CP | — |
| ICMP | any | any | — | Q6 | CP | — |
| VRRP | any | any | — | Q7 | CP | — |

FTOS#

Data Center Bridging (DCB)

The data center bridging (DCB) features are supported on the **S4810** and **S4820T**

This chapter describes the following data center bridging topics:

- [Ethernet Enhancements in Data Center Bridging](#)
- [Enabling Data Center Bridging](#)
- [Configuring Priority-Based Flow Control](#)
- [Configuring Enhanced Transmission Selection](#)
- [Applying DCB Policies in a Switch Stack](#)
- [Configuring DCBx Operation](#)
- [Verifying DCB Configuration](#)
- [PFC and ETS Configuration Examples](#)

Ethernet Enhancements in Data Center Bridging

In 8.3.12.0, the S4810 and S4820T can support loading two DCB_Config files:

- FCoE_DCB_Config
- iSCSI_DCB_Config

These files are located in the root directory C:/CONFIG_TEMPLATE. After copying the config files to the startup config and reloading the system.

The S4810 and S4820T support the following DCB features:

- Data center bridging exchange protocol (DCBx)
- Priority-based Flow Control (PFC)
- Enhanced Transmission Selection (ETS)

Data center bridging (DCB) refers to a set of IEEE Ethernet enhancements that provide data centers with a single, robust, converged network to support multiple traffic types, including local area network (LAN), server, and storage traffic. Through network consolidation, DCB results in reduced operational cost, simplified management, and easy scalability by avoiding the need to deploy separate application-specific networks.

For example, instead of deploying an Ethernet network for LAN traffic, additional storage area networks (SANs) to ensure lossless fiber-channel traffic, and a separate InfiniBand network for high-performance inter-processor computing within server clusters, only one DCB-enabled network is required in a data center. The Dell Force10 switches that support a unified fabric and consolidate multiple network infrastructures use a single input/output (I/O) device called a converged network adapter (CNA).

A CNA is a computer input/output device that combines the functionality of a host bus adapter (HBA) with a network interface controller (NIC). Multiple adapters on different devices for several traffic types are no longer required.

Data center bridging satisfies the needs of the following types of data center traffic in a unified fabric:

- LAN traffic consists of a large number of flows that are generally insensitive to latency requirements, while certain applications, such as streaming video, are more sensitive to latency. Ethernet functions as a best-effort network that may drop packets in case of network congestion. IP networks rely on transport protocols (for example, TCP) for reliable data transmission with the associated cost of greater processing overhead and performance impact.
- Storage traffic based on Fibre Channel media uses the SCSI protocol for data transfer. This traffic typically consists of large data packets with a payload of 2K bytes that cannot recover from frame loss. To successfully transport storage traffic, data center Ethernet must provide no-drop service with lossless links.
- Servers use InterProcess Communication (IPC) traffic within high-performance computing clusters to share information. Server traffic is extremely sensitive to latency requirements.

To ensure lossless delivery and latency-sensitive scheduling of storage and service traffic and I/O convergence of LAN, storage, and server traffic over a unified fabric, IEEE data center bridging adds the following extensions to a classical Ethernet network:

- 802.1Qbb - Priority-based Flow Control (PFC)
- 802.1Qaz - Enhanced Transmission Selection (ETS)
- 802.1Qau - Congestion Notification
- Data Center Bridging Exchange (DCBx) protocol



Note: In FTOS version 8.3.12.0, only the PFC, ETS, and DCBx features are supported in data center bridging.

Priority-Based Flow Control

In a data center network, priority-based flow control (PFC) manages large bursts of one traffic type in multiprotocol links so that it does not affect other traffic types and no frames are lost due to congestion. When PFC detects congestion on a queue for a specified priority, it sends a pause frame for the 802.1p priority traffic to the transmitting device. In this way, PFC ensures that large amounts of queued LAN traffic do not cause storage traffic to be dropped, and that storage traffic does not result in high latency for high-performance computing (HPC) traffic between servers.

PFC enhances the existing 802.3x pause and 802.1p priority capabilities to enable flow control based on 802.1p priorities (classes of service). Instead of stopping all traffic on a link (as performed by the traditional Ethernet pause mechanism), PFC pauses traffic on a link according to the 802.1p priority set on a traffic type. You can create lossless flows for storage and server traffic while allowing for loss in case of LAN traffic congestion on the same physical interface.

Figure 13-1 shows how PFC handles traffic congestion by pausing the transmission of incoming traffic with dot1p priority 4.

Figure 13-1. Priority-Based Flow Control

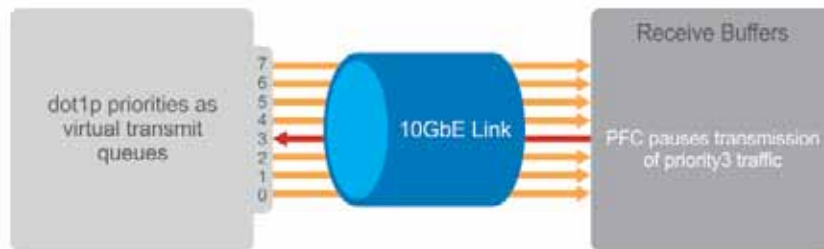

PFC is implemented as follows in the Dell Force10 operating software (FTOS):

- PFC is supported on specified 802.1p priority traffic (dot1p 0 to 7) and is configured per interface. However, only two lossless queues are supported on an interface: one for FCoE converged traffic and one for iSCSI storage traffic. You must configure the same lossless queues on all ports.
- PFC delay constraints place an upper limit on the transmit time of a queue after receiving a message to pause a specified priority.
- By default, PFC is enabled when DCB is enabled. If FCoE_DCB_Config and iSCSI_DCB_Config have not been loaded and DCB is disabled. When DCB is enabled globally, TX and RX cannot be enabled simultaneously on the interface for flow control and link-level flow control is disabled.
- During DCBx negotiation with a remote peer:
 - DCBx communicates with the remote peer by LLDP TLV to determine current policies, such as PFC support and ETS BW allocation.
 - If the negotiation fails and PFC is enabled on the port, any user-configured PFC input policies are applied. If no PFC input policy has been previously applied, the PFC default setting is used (no priorities configured). If you do not enable PFC on an interface, you can enable the 802.3x link-level pause function. By default, the link-level flow pause is disabled when DCBx and PFC are enabled. If no PFC input policy has been applied on the interface, the default PFC settings are used.
 - If DCBx negotiation is not successful (due to, for example, a version or TLV mismatch), DCBx will be disabled and PFC or ETS cannot be enabled.
- PFC supports buffering to receive data that continues to arrive on an interface while the remote system reacts to the PFC operation.
- PFC uses the DCB MIB IEEE 802.1azd2.5 and the PFC MIB IEEE 802.1bb-d2.2.

Enhanced Transmission Selection

Enhanced transmission selection (ETS) supports optimized bandwidth allocation between traffic types in multiprotocol (Ethernet, FCoE, SCSI) links. ETS allows you to divide traffic according to its 802.1p priority into different priority groups (traffic classes) and configure bandwidth allocation and queue scheduling for each group to ensure that each traffic type is correctly prioritized and receives its required bandwidth. For example, you can prioritize low-latency storage or server cluster traffic in a traffic class to receive more bandwidth and restrict best-effort LAN traffic assigned to a different traffic class.

Although you can configure strict-priority queue scheduling for a priority group, ETS introduces flexibility that allows the bandwidth allocated to each priority group to be dynamically managed according to the amount of LAN, storage, and server traffic in a flow. Unused bandwidth is dynamically allocated to prioritized priority groups. Traffic is queued according to its 802.1p priority assignment, while flexible bandwidth allocation and the configured queue-scheduling for a priority group is supported.

Figure 13-2 shows how ETS allows you to allocate bandwidth when different traffic types are classed according to 802.1p priority and mapped to priority groups.

Figure 13-2. Enhanced Transmission Selection

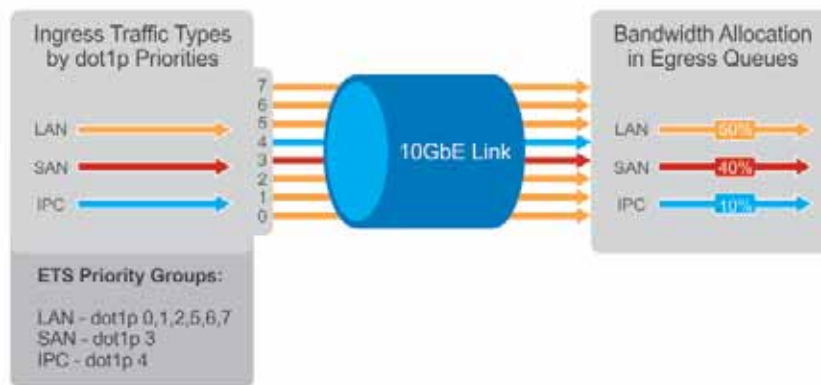

ETS uses the following traffic groupings to select multiprotocol traffic for transmission:

- Priority group: A group of 802.1p priorities used for bandwidth allocation and queue scheduling. All 802.1p priority traffic in a group should have the same traffic handling requirements for latency and frame loss.
- Group ID: A 4-bit identifier assigned to each priority group. Range is from 0 to 7.
- Group bandwidth: Percentage of available bandwidth allocated to a priority group.
- Group transmission selection algorithm (TSA): Type of queue scheduling used by a priority group.

ETS is implemented as follows in FTOS:

- ETS supports groups of 802.1p priorities that have:
 - PFC enabled or disabled
 - No bandwidth limit or no ETS processing

- Bandwidth allocated by the ETS algorithm is made available after strict-priority groups are serviced. If a priority group does not use its allocated bandwidth, the unused bandwidth is made available to other priority groups.
- For ETS traffic selection, an algorithm is applied to priority groups using:
 - Strict-priority shaping
 - ETS shapingCredit-based shaping is not supported.
- ETS uses the DCB MIB IEEE 802.1azd2.5.

Data Center Bridging Exchange Protocol (DCBx)

The data center bridging exchange (DCBx) protocol is disabled by default on the S4810 and S4820T; ETS is also disabled. DCBx allows a switch to automatically discover DCB-enabled peers and exchange configuration information. PFC and ETS use DCBx to exchange and negotiate parameters with peer devices. DCBx capabilities include:

- Discovery of DCB capabilities on peer-device connections
- Determination of possible mismatch in DCB configuration on a peer link
- Configuration of a peer device over a DCB link

DCBx requires the link layer discovery protocol (LLDP) to provide the path to exchange DCB parameters with peer devices. Exchanged parameters are sent in organizationally specific type, length, values (TLVs) in LLDP data units. For more information, refer to [Chapter 29, Link Layer Discovery Protocol \(LLDP\)](#). The following LLDP TLVs are supported for DCB parameter exchange:

- PFC parameters: PFC Configuration TLV and Application Priority Configuration TLV.
- ETS parameters: ETS Configuration TLV and ETS Recommendation TLV.

Data Center Bridging in a Traffic Flow

The following figure shows how DCB handles a traffic flow on an interface.

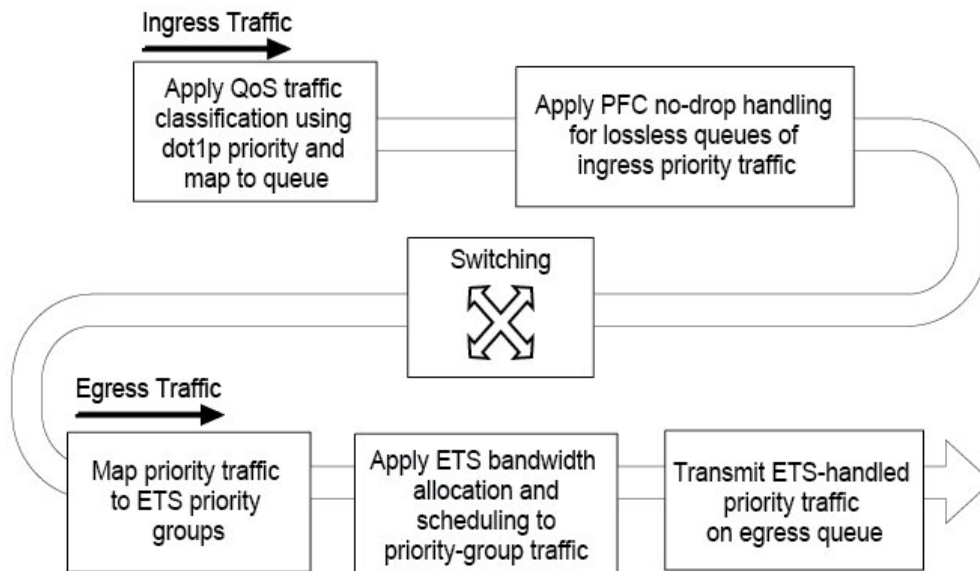
Figure 13-3. DCB PFC and ETS Traffic Handling

Enabling Data Center Bridging

Data center bridging (DCB) is automatically configured when FCoE or iSCSI Optimization are configured. Data center bridging supports converged enhanced Ethernet (CEE) in a data center network. DCB is disabled by default. It must be enabled to support CEE.

- Priority-based flow control
- Enhanced transmission selection
- Data center bridging exchange protocol
- FCoE initialization protocol (FIP) snooping

DCB processes virtual local area network (VLAN)-tagged packets and dot1p priority values. Untagged packets are treated with a dot1p priority of 0.

For DCB to operate effectively, you can classify ingress traffic according to its dot1p priority so that it maps to different data queues. The dot1p-queue assignments used are shown in [Table 13-1](#).

To enable DCB, you must enable either the iSCSI Optimization configuration or the FCoE configuration. For information to configure iSCSI Optimization, refer to [Enabling and Disabling iSCSI Optimization](#). For information to configure FCoE, refer to Step 1 in [Configuring FIP Snooping](#).

To enable DCB with PFC buffers on a switch, enter the following commands, save the configuration, and reboot the system to allow the changes to take effect:

| Task | Command | Command Mode |
|-------------|------------|---------------|
| Enable DCB. | dcb enable | CONFIGURATION |

| Task | Command | Command Mode |
|--|---|---------------|
| Set PFC buffering on the DCB stack unit. | dcb stack-unit all pfc-buffering pfc-ports 64 pfc-queues 2 | CONFIGURATION |

Note: Save the configuration and reboot the system to save the pfc buffering configuration changes.



FTOS Behavior:

DCB is not supported if you enable link-level flow control on one or more interfaces (refer to [Ethernet Pause Frames on page 470](#)).

QoS dot1p Traffic Classification and Queue Assignment

DCB supports PFC, ETS, and DCBx to handle converged Ethernet traffic that is assigned to an egress queue according to the following quality of service (QoS) methods:

- Honor dot1p: Using the `service-class dynamic dot1p` command in INTERFACE configuration mode, you can honor dot1p priorities in ingress traffic at the port or global switch level (refer to [Default dot1p to Queue Mapping](#)).
- Layer 2 class maps: You can use dot1p priorities to classify traffic in a class map and apply a service policy to an ingress port to map traffic to egress queues (refer to [Policy-based QoS Configurations](#)).



Note: Dell Force10 does not recommend mapping all ingress traffic to a single queue when using PFC and ETS. Ingress traffic classification using the `service-class dynamic dot1p` command (honor dot1p) is recommended on all DCB-enabled interfaces. If you use L2 class maps to map dot1p priority traffic to egress queues, take into account the default dot1p-queue assignments in [Table 13-1](#) and the maximum number of two lossless queues supported on a port (refer to [Configuring Lossless Queues](#)).

Although FTOS allows you to change the default dot1p priority-queue assignments (refer to [Set dot1p Priorities for Incoming Traffic](#)), DCB policies applied to an interface may become invalid if dot1p-queue mapping is reconfigured. If the configured DCB policy remains valid, the change in the dot1p-queue assignment is allowed.

Table 13-1. dot1p Priority-Queue Assignment

| dot1p Value in Incoming Frame | Egress Queue Assignment |
|-------------------------------|-------------------------|
| 0 | 0 |
| 1 | 0 |
| 2 | 0 |
| 3 | 1 |
| 4 | 2 |
| 5 | 3 |
| 6 | 3 |
| 7 | 3 |

Configuring Priority-Based Flow Control

Priority-based flow control (PFC) provides a flow control mechanism based on the 802.1p priorities in converged Ethernet traffic received on an interface and is enabled by default when DCB is enabled. As an enhancement to the existing Ethernet pause mechanism, PFC stops traffic transmission for specified priorities (CoS values) without impacting other priority classes. Different traffic types are assigned to different priority classes.

When traffic congestion occurs, PFC sends a pause frame to a peer device with the CoS priority values of the traffic that needs to be stopped. DCBx provides the link-level exchange of PFC parameters between peer devices. PFC allows network administrators to create zero-loss links for SAN traffic that requires no-drop service, while at the same time retaining packet-drop congestion management for LAN traffic.

To ensure complete no-drop service, you must apply the same DCB input policy with the same pause time and dot1p priorities on all PFC-enabled peer interfaces.

To configure PFC and apply a PFC input policy to an interface, follow these steps:

| Step | Task | Command | Command Mode |
|------|--|---|------------------|
| 1 | Create a DCB input policy to apply pause or flow control for specified priorities using a configured delay time. Maximum: 32 alphanumeric characters. | <code>dcb-input <i>policy-name</i></code> | CONFIGURATION |
| 2 | Configure the link delay used to pause specified priority traffic. One quantum is equal to a 512-bit transmission. Range (in quanta): 712-65535. Default: 45556 quantum in link delay. | <code>pfc link-delay <i>value</i></code> | DCB INPUT POLICY |

| Step | Task | Command | Command Mode |
|------|--|--|------------------|
| 3 | Configure the CoS traffic to be stopped for the specified delay. Enter the 802.1p values of the frames to be paused. Range: 0-7. Default: None. Maximum number of loss less queues supported on the switch: 2. Separate priority values with a comma. Specify a priority range with a dash, for example: pfc priority 1,3,5-7. | pfc priority <i>priority-range</i> | DCB INPUT POLICY |
| 4 | Enable the PFC configuration on the port so that the priorities are included in DCBx negotiation with peer PFC devices. Default: PFC mode is on. | pfc mode on | DCB INPUT POLICY |
| 5 | (Optional) Enter a text description of the input policy. Maximum: 32 characters. | description <i>text</i> | DCB INPUT POLICY |
| 6 | Exit DCB input policy configuration mode. | exit | DCB INPUT POLICY |
| 7 | Enter interface configuration mode. | interface type <i>slot/port</i> | CONFIGURATION |
| 8 | Apply the input policy with the PFC configuration to an ingress interface. | dcb-policy input <i>policy-name</i> | INTERFACE |
| 9 | Repeat Steps 1 to 8 on all PFC-enabled peer interfaces to ensure lossless traffic service. | | |



FTOS Behavior:

As soon as you apply a DCB policy with PFC enabled on an interface, DCBx starts exchanging information with PFC-enabled peers. The IEEE802.1Qbb, CEE and CIN versions of PFC TLV are supported. DCBx also validates PFC configurations that are received in TLVs from peer devices.

By applying a DCB input policy with PFC enabled, you enable PFC operation on ingress port traffic. To achieve complete lossless handling of traffic, you must also enable PFC on all DCB egress ports or configure the dot1p priority-queue assignment of PFC priorities to lossless queues (refer to [Configuring Lossless Queues](#)).

To remove a DCB input policy, including the PFC configuration it contains, use the **no dcb-input policy-name** command in INTERFACE Configuration mode. To disable PFC operation on an interface, use the **no pfc mode on** command in DCB Input Policy Configuration mode. PFC is enabled and disabled as the global DCB operation is enabled (**dcb enable**) or disabled (**no dcb enable**).

You can enable any number of 802.1p priorities for PFC. Queues to which PFC priority traffic is mapped are lossless by default. Traffic may be interrupted due to an interface flap (going down and coming up) when you reconfigure the lossless queues for no-drop priorities in a PFC input policy and re-apply the policy to an interface.

For PFC to be applied, the configured priority traffic must be supported by a PFC peer (as detected by DCBx).

To honor a PFC pause frame multiplied by the number of PFC-enabled ingress ports, the minimum link delay should be greater than the round-trip transmission time required by a peer.

If you apply an input policy with PFC disabled (**no pfc mode on**):

- Link-level flow control can be enabled on the interface (refer to [Ethernet Pause Frames on page 470](#)).
- To delete the input policy, you must first disable link-level flow control. PFC is then automatically enabled on the interface because an interface is by default PFC-enabled.
- PFC still allows you to configure lossless queues on a port to ensure no-drop handling of lossless traffic (refer to [Configuring Lossless Queues](#)).

PFC and link-level flow control cannot be enabled at the same time on an interface.

When you apply an input policy to an interface, an error message is displayed if:

- The PFC dot1p priorities result in more than two lossless port queues globally on the switch.
- Link-level flow control is already enabled. PFC and link-level flow control cannot be enabled at the same time on an interface.
- In a switch stack, you must configure all stacked ports with the same PFC configuration.

A DCB input policy for PFC applied to an interface may become invalid if dot1p-queue mapping is reconfigured (refer to [Create Input Policy Maps](#) in [Chapter 38, Quality of Service \(QoS\)](#)). This situation occurs when the new dot1p-queue assignment exceeds the maximum number (2) of lossless queues supported globally on the switch. In this case, all PFC configurations received from PFC-enabled peers are removed and re-synchronized with the peer devices.

Traffic may be interrupted when you reconfigure PFC no-drop priorities in an input policy or re-apply the policy to an interface.

Configuring Lossless Queues

DCB also supports the manual configuration of lossless queues on an interface when PFC mode is turned off and priority classes are disabled in a DCB input policy applied to the interface. The configuration of no-drop queues provides flexibility for ports on which PFC is not needed but lossless traffic should egress from the interface.

Lossless traffic egresses out the no-drop queues. Ingress dot1p traffic from PFC-enabled interfaces is automatically mapped to the no-drop egress queues.

Prerequisite: A DCB input policy with PFC configuration is applied to the interface with the following conditions:

- PFC mode is off (no `pfc mode on`).
- No PFC priority classes are configured (no `pfc priority priority-range`).

To configure lossless queues on a port interface, follow these steps:

| Step | Task | Command | Command Mode |
|------|---|--|---------------|
| 1 | Enter INTERFACE Configuration mode. | <code>interface type <i>slot/port</i></code> | CONFIGURATION |
| 2 | Configure the port queues that will still function as no-drop queues for lossless traffic. For the dot1p-queue assignments, refer to Table 13-1 . Maximum number of lossless queues globally supported on the switch: 2. Range: 0-3. Separate queue values with a comma; specify a priority range with a dash; for example: <code>pfc no-drop queues 1,3</code> or <code>pfc no-drop queues 2-3</code> Default: No lossless queues are configured. | <code>pfc no-drop queues <i>queue-range</i></code> | INTERFACE |



FTOS Behavior:

By default, no lossless queues are configured on a port.

A limit of two lossless queues are supported on a port. If the amount of priority traffic that you configure to be paused exceeds the two lossless queues, an error message is displayed. You must reconfigure the input policy using a smaller number of PFC priorities.

If you configure lossless queues on an interface that already has a DCB input policy with PFC enabled (**pfc mode on**), an error message is displayed.

Configuring the PFC Buffer in a Switch Stack

In a switch stack, you must configure all stacked ports with the same PFC configuration. In addition, you must configure a separate buffer of memory allocated exclusively to a service pool accessed by queues on which priority-based control flows are mapped.

These PFC-enabled queues ensure the lossless transmission of storage and server traffic. The buffer required for the PFC service pool is calculated based on the number of ports and port queues used by PFC traffic.

You can configure the size of the PFC buffer for all switches in a stack or all port pipes on a specified stack unit by entering the following commands on the master switch:

| Task | Command | Command Mode |
|---|---|---------------|
| Configure the PFC buffer for all switches in the stack. Default: The PFC buffer is enabled on all ports on the stack unit. | [no] dcb stack-unit all pfc-buffering pfc-port {1-64} pfc-queues {1-2} | CONFIGURATION |
| Configure the PFC buffer for all port pipes in a specified stack unit by specifying the port-pipe number, number of PFC-enabled ports, and number of configured lossless queues. Valid stack-unit IDs are 0 to 5. The only valid port-set ID (port-pipe number) is 0. | [no] dcb stack-unit <i>stack-unit-id</i> [port-set <i>port-set-id</i>] pfc-buffering pfc-ports {1-64} pfc-queues {1-2} | CONFIGURATION |



FTOS Behavior:

If you configure PFC on a 40GbE port, count the 40GbE port as four PFC-enabled ports in the **pfc-port** number you enter in the command syntax.

To achieve lossless PFC operation, the PFC port count and queue number used for the reserved buffer size that is created must be greater than or equal to the buffer size required for PFC-enabled ports and lossless queues on the switch.

For the PFC buffer configuration to take effect, you must reload the stack or a specified stack unit (**reload** command at the EXEC Privilege level).

DCB and Switch Stacking Caveats for the S4820T

The following is a list of behaviors and limitations regarding the use of DCB over S4820T ports involved in switch stacking:

- You can enable DCB only on 40 Gig (QSPF+) ports.
- DCB is not supported over any of the 48 RJ-45 10 Gig ports while they are configured in stacking mode.
- You cannot configure stacking on any of the 48 RJ-45 10 Gig ports, if DCB is enabled on any of the 40 Gig stacking ports.
- If DCB is enabled, it will disable the ability to use any of the 48 10 Gig ports for stacking.

Configuring Enhanced Transmission Selection

Enhanced transmission selection (ETS) provides a way to optimize bandwidth allocation to outbound 802.1p classes of converged Ethernet traffic. Different traffic types have different service needs. Using ETS, you can create groups within an 802.1p priority class to configure different treatment for traffic with different bandwidth, latency, and best-effort needs.

For example, storage traffic is sensitive to frame loss; interprocess communication (IPC) traffic is latency-sensitive. ETS allows different traffic types to coexist without interruption in the same converged link by:

- Allocating a guaranteed share of bandwidth to each priority group
- Allowing each group to exceed its minimum guaranteed bandwidth if another group is not fully using its allotted bandwidth

To configure ETS and apply an ETS output policy to an interface, you must:

1. Create a QoS output policy with ETS scheduling and bandwidth allocation settings.
2. Create a priority group of 802.1p traffic classes.
3. Configure a DCB output policy in which you associate a priority group with a QoS ETS output policy.
4. Apply the DCB output policy to an interface.

ETS Prerequisites and Restrictions

The following prerequisites and restrictions apply when you configure ETS bandwidth allocation or queue scheduling and apply a QoS ETS output policy on an interface:

- Configuring ETS bandwidth allocation or a queue scheduler for dot1p priorities in a priority group is applicable if the DCBx version used on a port is CIN (refer to [Configuring DCBx on an Interface](#)) or CEE as a port version where CNA supports CEE and DUT port versions in AUTO or CEE mode.

- When allocating bandwidth or configuring a queue scheduler for dot1p priorities in a priority group on a DCBx CIN interface, take into account the CIN bandwidth allocation ([Configuring Bandwidth Allocation for DCBx CIN](#)) and dot1p-queue mapping ([Table 13-1](#)).
- Although an ETS output policy does not support WRED, ECN, rate shaping, and rate limiting because these parameters are not negotiated by DCBx with peer devices, you can apply a QoS output policy with WRED and/or rate shaping on a DCBx CIN-enabled interface (refer to [Configure Port-based Rate Shaping on page 763](#) and [Weighted Random Early Detection](#)). In this case, the WRED or rate shaping configuration in the QoS output policy should take into account the bandwidth allocation or queue scheduler configured in the ETS output policy.
- You can only use a QoS ETS output policy in association with a priority group in a DCB output policy and cannot be applied to an interface as a normal QoS output policy (refer to [Applying an ETS Output Policy for a Priority Group to an Interface](#) and [Create an output QoS policy in Chapter 38, Quality of Service \(QoS\)](#)).



Note: The IEEE 802.1Qaz, CEE, and CIN versions of ETS are supported.

Creating a QoS ETS Output Policy

A QoS output policy that you create to optimize bandwidth on an output interface for specified priority traffic consists of the ETS settings used in DCBx negotiations with peer devices:

- Bandwidth percentage
- Queue scheduling

To create a QoS output policy with ETS settings, follow these steps:

| Step | Task | Command | Command Mode |
|------|--|---|--------------------|
| 1 | Create a QoS output policy to configure the ETS bandwidth allocation and scheduling for priority traffic. Maximum: 32 characters. | <code>qos-policy-output <i>policy-name</i> ets</code> | CONFIGURATION |
| 2 | (Optional) Configure the method used to schedule priority traffic in port queues. <ul style="list-style-type: none"> • <code>strict</code> - Strict priority traffic is serviced before any other queued traffic (refer to Strict-priority Queueing in Chapter 38, Quality of Service (QoS)). Note: If you configure a scheduling method, you cannot configure bandwidth allocation in Step 3. | <code>scheduler <i>value</i></code> | POLICY-MAP-OUT-ETS |

| Step | Task | Command | Command Mode |
|------|--|--|--------------------|
| 3 | <p>(Optional) Configure the bandwidth percentage allocated to priority traffic in port queues. Percentage range: 1 to 100% in units of 1%. The sum of bandwidth percentage assigned to dot1p priorities/queues in a priority group should be 100%. Default: None.</p> <p>Note: If you configure bandwidth allocation, you cannot configure a scheduling method in Step 2.</p> | <code>bandwidth-percentage percentage</code> | POLICY-MAP-OUT-ETS |
| 4 | Exit ETS Output Policy Configuration mode. | <code>exit</code> | POLICY-MAP-OUT-ETS |

**FTOS Behavior:**

Traffic in priority groups is assigned to strict-queue or WERR scheduling in an ETS output policy and is managed using the ETS bandwidth-assignment algorithm. FTOS de-queues all frames of strict-priority traffic before servicing any other queues. A queue with strict-priority traffic can starve other queues in the same port.

ETS-assigned bandwidth allocation and scheduling apply only to data queues, not to control queues.

FTOS supports hierarchical scheduling on an interface. FTOS control traffic is redirected to control queues as higher priority traffic with strict priority scheduling. After control queues drain out, the remaining data traffic is scheduled to queues according to the bandwidth and scheduler configuration in the ETS output policy. The available bandwidth calculated by the ETS algorithm is equal to the link bandwidth after scheduling non-ETS higher-priority traffic.

The configuration of bandwidth allocation and strict-queue scheduling is not supported at the same time for a priority group. If both are configured, the configured bandwidth allocation is ignored for priority-group traffic when you apply the output policy on an interface (refer to [Applying an ETS Output Policy for a Priority Group to an Interface](#)).

Bandwidth assignment in a dot.1p priority-queue: By default, equal bandwidth is assigned to each port queue and each dot1p priority in a priority group. Use the **bandwidth-percentage** command to configure bandwidth amounts in associated dot1p queues. When specified bandwidth is assigned to some port queues and not to others, the remaining bandwidth (100% minus assigned bandwidth amount) is equally distributed to unassigned non-strict priority queues in the priority group. The sum of the allocated bandwidth to all queues in a priority group should be 100% of the bandwidth on the link.

Bandwidth assignment in a priority group: By default, equal bandwidth is assigned to each priority group in the ETS output policy applied to an egress port if you did not configure bandwidth allocation. The sum of configured bandwidth allocation to dot1p priority traffic in all ETS priority groups must be 100%. You must allocate at least 1% of the total bandwidth to each priority group and queue. If you assign bandwidth to some priority groups but not to others, the remaining bandwidth (100% minus assigned bandwidth amount) is equally distributed to non-strict-priority groups which have no configured scheduler.

Scheduling of priority traffic: dot1p priority traffic on the switch is scheduled to the current queue mapping. dot1p priorities within the same queue should have the same traffic properties and scheduling method.

ETS output-policy error: If an error occurs in an ETS output-policy configuration, the configuration is ignored and the scheduler and bandwidth allocation settings are reset to the ETS default values (all priorities are in the same ETS priority group and bandwidth is allocated equally to each priority). If an error occurs when a port receives a peer's ETS configuration, the port's configuration is reset to the previously configured ETS output policy. If no ETS output policy was previously applied, the port is reset to the default ETS parameters.

Creating an ETS Priority Group

An ETS priority group specifies the range of 802.1p priority traffic to which a QoS output policy with ETS settings is applied on an egress interface. You can associate a priority group to more than one ETS output policy on different interfaces.

To create a priority group for ETS, follow these steps:

| Step | Task | Command | Command Mode |
|------|--|---|----------------|
| 1 | Create an ETS priority group to use with an ETS output policy. Maximum: 32 characters. | <code>priority-group <i>group-name</i></code> | CONFIGURATION |
| 2 | Configure the priority-group identifier. Range: 0 to 7. Default: None. | <code>set-pgid <i>value</i></code> | PRIORITY-GROUP |
| 3 | Configure the 802.1p priorities for the traffic on which you want to apply an ETS output policy. Range: 0 to 7. Default: None. Separate priority values with a comma. Specify a priority range with a dash. For example: <code>priority-list 3,5-7.</code> | <code>priority-list <i>value</i></code> | PRIORITY-GROUP |
| 4 | Exit priority-group configuration mode. | <code>exit</code> | PRIORITY-GROUP |
| 5 | Repeat Steps 1 to 4 to configure all remaining dot1p priorities in an ETS priority group. | | |

FTOS Behavior:



A priority group consists of 802.1p priority values that are grouped together for similar bandwidth allocation and scheduling, and that share the same latency and loss requirements. All 802.1p priorities mapped to the same queue should be in the same priority group.

All 802.1p priorities should be configured in priority groups associated with an ETS output policy (refer to [Applying an ETS Output Policy for a Priority Group to an Interface](#)). You can assign each dot1p priority to only one priority group.

By default:

- All 802.1p priorities are grouped in priority group 0.
- 100% of the port bandwidth is assigned to priority group 0. The complete bandwidth is equally assigned to each priority class so that each class has 12 to 13%.

The maximum number of priority groups supported in ETS output policies on an interface is equal to the number of data queues (4) on the port. The 802.1p priorities in a priority group can map to multiple queues.

If you configure more than one priority queue as strict priority or more than one priority group as strict priority, the higher numbered priority queue is given preference when scheduling data traffic.

Applying an ETS Output Policy for a Priority Group to an Interface

To apply ETS on egress port traffic, you must associate a priority group with an ETS output policy which has scheduling and bandwidth configuration in a DCB output policy, and then apply the output policy to an interface.

To apply ETS on egress port traffic, follow these steps:

| Step | Task | Command | Command Mode |
|------|--|---|-------------------|
| 1 | Create a DCB output policy to associate an ETS configuration with priority traffic. Maximum: 32 alphanumeric characters. | <code>dcb-output <i>policy-name</i></code> | CONFIGURATION |
| 2 | Enable the ETS configuration so that scheduling and bandwidth allocation configured in an ETS output policy or received in a DCBx TLV from a peer can take effect on an interface. Default: ETS mode is on. | <code>ets mode on</code> | DCB OUTPUT POLICY |
| 3 | Associate the 802.1p priority traffic in a priority group with the ETS configuration in a QoS output policy. | <code>priority-group <i>group-name</i></code> <code>qos-policy <i>ets-policy-name</i></code> | DCB OUTPUT POLICY |
| 4 | (Optional) Enter a text description of the output policy. Maximum: 32 characters. | <code>description <i>text</i></code> | DCB OUTPUT POLICY |
| 5 | Repeat Steps 1 to 4 to configure all remaining ETS priority groups with an ETS output policy. | | |
| 6 | Exit DCB Output Policy Configuration mode. | <code>exit</code> | DCB OUTPUT POLICY |
| 7 | Enter INTERFACE Configuration mode. | <code>interface type <i>slot/port</i></code> | CONFIGURATION |
| 8 | Apply the output policy with the ETS configuration to an egress interface. | <code>dcb-policy output <i>policy-name</i></code> | INTERFACE |

FTOS Behavior:

Create a DCB output policy to associate a priority group with an ETS output policy with scheduling and bandwidth configuration. You can apply a DCB output policy on multiple egress ports.

The ETS configuration associated with 802.1p priority traffic in a DCB output policy is used in DCBx negotiation with ETS peers.

When you apply an ETS output policy to an interface, ETS-configured scheduling and bandwidth allocation take precedence over any configured settings in the QoS output policies.

To remove an ETS output policy from an interface, use the **no dcb-policy output** *policy-name* command. DCB and ETS are both disabled by default. When DCB is enabled, ETS is enabled on all interfaces that have the default ETS configuration applied.

If you disable ETS in an output policy applied to an interface (the **no ets mode on** command), any previously configured QoS settings at the interface or global level take effect. If QoS settings are configured at the interface or global level and in an output policy map (the **service-policy output** command), the QoS configuration in the output policy take precedence.

ETS Operation with DCBx

In DCBx negotiation with peer ETS devices, ETS configuration is handled as follows:

- ETS TLVs are supported in DCBx versions CIN, CEE, and IEEE2.5.
- ETS operational parameters are determined by the DCBx port-role configurations (see [Configuring DCBx Operation](#)).
- ETS configurations received from TLVs from a peer are validated.
- In case of a hardware limitation or TLV error:
 - DCBx operation on an ETS port goes down.
 - New ETS configurations are ignored and existing ETS configurations are reset to the previously configured ETS output policy on the port or to the default ETS settings if no ETS output policy was previously applied.
- ETS operates with legacy DCBx versions as follows:
 - In the CEE version, the priority group/traffic class group (TCG) ID 15 represents a non-ETS priority group. Any priority group configured with a scheduler type is treated as a strict-priority group and is given the priority-group (TCG) ID 15.
 - The CIN version supports two types of strict-priority scheduling:
 - Group strict priority: Allows a single priority flow in a priority group to increase its bandwidth usage to the bandwidth total of the priority group. A single flow in a group can use all the bandwidth allocated to the group.
 - Link strict priority: Allows a flow in any priority group to increase to the maximum link bandwidth.

CIN supports only the dot1p priority-queue assignment in a priority group. To configure a dot1p priority flow in a priority group to operate with link strict priority, you must configure:

- The dot1p priority for strict-priority scheduling (**strict-priority** command; [Strict-priority Queuing](#))

- The priority group for strict-priority scheduling (**scheduler strict** command; [Creating a QoS ETS Output Policy](#))

If you configure only the priority group in an ETS output policy or only the dot1p priority for strict-priority scheduling, the flow is handled with group strict priority.

Configuring Bandwidth Allocation for DCBx CIN

After you apply an ETS output policy to an interface, if the DCBx version used in your data center network is CIN, you may need to configure a QoS output policy to overwrite the default CIN bandwidth allocation. This default setting divides the bandwidth allocated to each port queue equally between the dot1p priority traffic assigned to the queue.

For more information, refer to [Allocate bandwidth to queue](#).

To create a QoS output policy that allocates different amounts of bandwidth to the different traffic types/dot1p priorities assigned to a queue and apply the output policy to the interface, follow these steps.

| Step | Task | Command | Command Mode |
|------|---|---|-------------------|
| 1 | Create a QoS output policy. Maximum: 32 alphanumeric characters. | <code>qos-policy-output output-policy-name</code> | CONFIGURATION |
| 2 | Configure the percentage of bandwidth to be allocated to the dot1p priority/queue traffic in the associated L2 class map. Default: None. | <code>bandwidth-percentage percentage</code> | QoS OUTPUT POLICY |
| 3 | Repeat Step 2 to configure bandwidth percentages for other priority queues on the port. | <code>bandwidth-percentage percentage</code> | QoS OUTPUT POLICY |
| 4 | Exit QoS Output Policy Configuration mode. | <code>exit</code> | QoS OUTPUT POLICY |
| 5 | Enter INTERFACE Configuration mode. | <code>interface type slot/port</code> | CONFIGURATION |
| 6 | Apply the QoS output policy with the bandwidth percentage for specified priority queues to an egress interface. | <code>service-policy output output-policy-name</code> | INTERFACE |

Applying DCB Policies in a Switch Stack

 **Note:** The S4820T does not support DCB on any of the 48 RJ-45 10 Gigabit stacking links.

You can apply a DCB input policy with PFC configuration to all stacked ports in a switch stack or on a stacked switch. You can apply different DCB input policies to different stacked switches.

| Task | Command | Command Mode |
|---|--|---------------|
| Apply the specified DCB input policy on all ports of the switch stack or a single stacked switch. | <code>dcb-policy input stack-unit {all stack-unit-id} stack-ports all dcb-input-policy-name</code> | CONFIGURATION |

FTOS Behavior:



Entering the command removes all DCB input policies applied to stacked ports.

A **dcb-policy input stack-unit all** command overwrites any previous **dcb-policy input stack-unit stack-unit-id** configurations. Similarly, a **dcb-policy input stack-unit stack-unit-id** command overwrites any previous **dcb-policy input stack-unit all** configuration.

Entering the **no dcb-policy input stack-unit all** command removes all DCB input policies applied to stacked ports and resets PFC to its default settings. The **no dcb-policy input stack-unit stack-unit-id** command removes only the DCB input policy applied to the specified switch.

You can apply a DCB output policy with ETS configuration to all stacked ports in a switch stack or an individual stacked switch. In addition, you can apply different DCB output policies to different stack units.

| Task | Command | Command Mode |
|---|--|---------------|
| Apply the specified DCB output policy on all ports of the switch stack or a stacked switch. | <code>dcb-policy output stack-unit {all stack-unit-id} stack-ports all dcb-output-policy-name</code> | CONFIGURATION |

FTOS Behavior:



Entering the command removes all DCB input policies applied to stacked ports.

A **dcb-policy output stack-unit all** command overwrites any previous **dcb-policy output stack-unit stack-unit-id** configurations. Similarly, a **dcb-policy output stack-unit stack-unit-id** command overwrites any previous **dcb-policy output stack-unit all** configuration.

Entering the **no dcb-policy output stack-unit all** command removes all DCB output policies applied to stacked ports. The **no dcb-policy output stack-unit stack-unit-id** command removes only the DCB output policy applied to the specified switch.

Configuring DCBx Operation

The data center bridging exchange protocol (DCBx) is used by DCB devices to exchange configuration information with directly connected peers using the link layer discovery protocol (LLDP) protocol. DCBx can detect the mis-configuration of a peer DCB device, and optionally, configure peer DCB devices with DCB feature settings to ensure consistent operation in a data center network.

DCBx is a prerequisite for using DCB features, such as priority-based flow control (PFC) and enhanced traffic selection (ETS), to exchange link-level configurations in a converged Ethernet environment. DCBx is also deployed in topologies that support lossless operation for FCoE or iSCSI traffic. In these scenarios, all network devices are DCBx-enabled (DCBx is enabled end-to-end). For more information about how these features are implemented and used, refer to:

- [Configuring Priority-Based Flow Control](#)
- [Configuring Enhanced Transmission Selection](#)
- [FIP Snooping](#)
- [Chapter 13, Data Center Bridging \(DCB\)](#)

The following versions of DCBx are supported CIN, CEE, and IEEE2.5.

Prerequisite: DCBx requires the LLDP to be enabled on all DCB devices.

DCBx Operation

DCBx performs the following operations:

- Discovers DCB configuration (such as PFC and ETS) in a peer device.
- Detects DCB mis-configuration in a peer device; that is, when DCB features are not compatibly configured on a peer device and the local switch. Mis-configuration detection is feature-specific because some DCB features support asymmetric configuration.
- Reconfigures a peer device with the DCB configuration from its configuration source if the peer device is willing to accept configuration.
- Accepts the DCB configuration from a peer if a DCBx port is in “willing” mode to accept a peer’s DCB settings and then internally propagates the received DCB configuration to its peer ports.

DCBx Port Roles

Use the following DCBx port roles to enable the auto-configuration of DCBx-enabled ports and propagate DCB configurations learned from peer DCBx devices internally to other switch ports:

- **Auto-upstream:** The port advertises its own configuration to DCBx peers and is *willing* to receive peer configuration. The port also propagates its configuration to other ports on the switch.

The first auto-upstream that is capable of receiving a peer configuration is elected as the *configuration source*. The elected configuration source then internally propagates the configuration to other auto-upstream and auto-downstream ports. A port that receives an internally propagated configuration overwrites its local configuration with the new parameter values.

When an auto-upstream port (besides the configuration source) receives and overwrites its configuration with internally propagated information, one of the following actions is taken:

- If the peer configuration received is compatible with the internally propagated port configuration, the link with the DCBx peer is enabled.
- If the received peer configuration is not compatible with the currently configured port configuration, the link with the DCBx peer port is disabled and a syslog message for an incompatible configuration is generated. The network administrator must then reconfigure the peer device so that it advertises a compatible DCB configuration.

The configuration received from a DCBx peer or from an internally propagated configuration is not stored in the switch's running configuration.

On a DCBx port in an auto-upstream role, the PFC and application priority TLVs are enabled. ETS recommend TLVs are disabled and ETS configuration TLVs are enabled.

- **Auto-downstream:** The port advertises its own configuration to DCBx peers but is *not willing* to receive remote peer configuration. The port always accepts internally propagated configurations from a configuration source. An auto-downstream port that receives an internally propagated configuration overwrites its local configuration with the new parameter values.

When an auto-downstream port receives and overwrites its configuration with internally propagated information, one of the following actions is taken:

- If the peer configuration received is compatible with the internally propagated port configuration, the link with the DCBx peer is enabled.
- If the received peer configuration is not compatible with the currently configured port configuration, the link with the DCBx peer port is disabled and a syslog message for an incompatible configuration is generated. The network administrator must then reconfigure the peer device so that it advertises a compatible DCB configuration.

The internally propagated configuration is not stored in the switch's running configuration.

On a DCBx port in an auto-downstream role, all PFC, application priority, ETS recommend, and ETS configuration TLVs are enabled.

- **Configuration source:** The port is configured to serve as a source of configuration information on the switch. Peer DCB configurations received on the port are propagated to other DCBx auto-configured ports. If the peer configuration is compatible with a port configuration, DCBx is enabled on the port.

On a configuration-source port, the link with a DCBx peer is enabled when the port receives a DCB configuration that can be internally propagated to other auto-configured ports.

The configuration received from a DCBx peer is not stored in the switch's running configuration.

On a DCBx port that is the configuration source, all PFC and application priority TLVs are enabled. ETS recommend TLVs are disabled and ETS configuration TLVs are enabled.

- **Manual:** The port is configured to operate only with administrator-configured settings and does not auto-configure with DCB settings received from a DCBx peer or from an internally propagated configuration from the configuration source. If you enable DCBx, ports in Manual mode advertise their configurations to peer devices but do not accept or propagate internal or external configurations. Unlike other user-configured ports, the configuration of DCBx ports in Manual mode is saved in the running configuration.

On a DCBx port in a manual role, all PFC, application priority, ETS recommend, and ETS configuration TLVs are enabled.

When making a configuration change to a DCBx port in a Manual role, Dell Force10 recommends that you shut down the interface using the **shutdown** command, change the configuration, then re-activate the interface using the **no shutdown** command.

Default DCBx port role: Manual.



Note: On a DCBx port, application priority TLV advertisements are handled as follows:

- The application priority TLV is transmitted only if the priorities in the advertisement match the configured PFC priorities on the port.
- On auto-upstream and auto-downstream ports:
 - If a configuration source is elected, the ports send an application priority TLV based on the application priority TLV received on the configuration-source port. When an application priority TLV is received on the configuration-source port, the auto-upstream and auto-downstream ports use the internally propagated PFC priorities to match against the received application priority. Otherwise, these ports use their locally configured PFC priorities in application priority TLVs.
 - If no configuration source is configured, auto-upstream and auto-downstream ports check to see that the locally configured PFC priorities match the priorities in a received application priority TLV.
- On manual ports: An application priority TLV is advertised only if the priorities in the TLV match the PFC priorities configured on the port.

DCB Configuration Exchange

The DCBx protocol supports the exchange and propagation of configuration information for the following DCB features.

- Enhanced transmission selection (ETS)
- Priority-based flow control (PFC)

DCBx uses the following methods to exchange DCB configuration parameters:

- Asymmetric: DCB parameters are exchanged between a DCBx-enabled port and a peer port without requiring that a peer port and the local port use the same configured values for the configurations to be compatible. For example, ETS uses an asymmetric exchange of parameters between DCBx peers.
- Symmetric: DCB parameters are exchanged between a DCBx-enabled port and a peer port with the requirement that each configured parameter value is the same for the configurations to be compatible. For example, PFC uses a symmetric exchange of parameters between DCBx peers.

Configuration Source Election

When an auto-upstream or auto-downstream port receives a DCB configuration from a peer, the port first checks to see if there is an active configuration source on the switch.

- If a configuration source already exists, the received peer configuration is checked against the local port configuration. If the received configuration is compatible, the DCBx marks the port as DCBx-enabled. If the configuration received from the peer is not compatible, a warning message is logged and the DCBx frame error counter is incremented. Although DCBx is operationally disabled, the port keeps the peer link up and continues to exchange DCBx packets. If a compatible peer configuration is later received, DCBx is enabled on the port.
- If there is no configuration source, a port may elect itself as the configuration source. A port may become the configuration source if the following conditions exist:
 - No other port is the configuration source.
 - The port role is auto-upstream.

- The port is enabled with link up and DCBx enabled.
- The port has performed a DCBx exchange with a DCBx peer.
- The switch is capable of supporting the received DCB configuration values through either a symmetric or asymmetric parameter exchange.

A newly elected configuration source propagates configuration changes received from a peer to the other auto-configuration ports. Ports receiving auto-configuration information from the configuration source ignore their current settings and use the configuration source information.

Propagation of DCB Information

When an auto-upstream or auto-downstream port receives a DCB configuration from a peer, the port acts as a DCBx client and checks if a DCBx configuration source exists on the switch.

- If a configuration source is found, the received configuration is checked against the currently configured values that are internally propagated by the configuration source. If the local configuration is compatible with the received configuration, the port is enabled for DCBx operation and synchronization.
- If the configuration received from the peer is not compatible with the internally propagated configuration used by the configuration source, the port is disabled as a client for DCBx operation and synchronization and a syslog error message is generated. The port keeps the peer link up and continues to exchange DCBx packets. If a compatible configuration is later received from the peer, the port is enabled for DCBx operation.



Note: DCB configurations internally propagated from a configuration source do not overwrite the configuration on a DCBx port in a manual role.

When a configuration source is elected, all auto-upstream ports other than the configuration source are marked as *willing disabled*. The internally propagated DCB configuration is refreshed on all auto-configuration ports and each port may begin configuration negotiation with a DCBx peer again.

Auto-Detection and Manual Configuration of the DCBx Version

When operating in Auto-Detection mode (**DCBx version auto** command in the [DCBx Configuration Procedure](#)), a DCBx port automatically detects the DCBx version on a peer port. Legacy CIN and CEE versions are supported in addition to the standard IEEE version 2.5 DCBx.

A DCBx port detects a peer version after receiving a valid frame for that version. The local DCBx port reconfigures to operate with the peer version and maintains the peer version on the link until one of the following conditions occurs:

- The switch reboots.
- The link is reset (goes down and up).
- User-configured CLI commands require the version negotiation to restart.
- The peer times out.
- Multiple peers are detected on the link.

If you configure a DCBx port to operate with a specific version (**DCBx version {cee | cin | ieee-v2.5}** command in the [DCBx Configuration Procedure](#)), DCBx operations are performed according to the configured version, including fast and slow transmit timers and message formats. If a DCBx frame with a different version is received, a syslog message is generated and the peer version is recorded in the peer status table. If the frame cannot be processed, it is discarded and the discard counter is incremented.



Note: Because DCBx TLV processing is best effort, it is possible that CIN frames may be processed when DCBx is configured to operate in CEE mode and vice versa. In this case, the unrecognized TLVs cause the unrecognized TLV counter to be incremented, but the frame is processed and is not discarded.

Legacy DCBx (CIN and CEE) supports the DCBx control state machine that is defined to maintain the sequence number and acknowledge number sent in the DCBx control TLVs.

DCBx Example

Figure 13-4 shows how DCBx is used. The external 40GbE ports on the base module (ports 33 and 37) of two switches are used for uplinks configured as DCBx auto-upstream ports. The S4810 or S4820T is connected to third-party, top-of-rack (ToR) switches through 40GbE uplinks. The ToR switches are part of a Fibre Channel storage network.

- The internal ports (ports 1-32) connected to the 10GbE backplane are configured as auto-downstream ports.
On the S4810 and S4820T, PFC and ETS use DCBx to exchange link-level configuration with DCBx peer devices.

Figure 13-4. DCBx Sample Topology

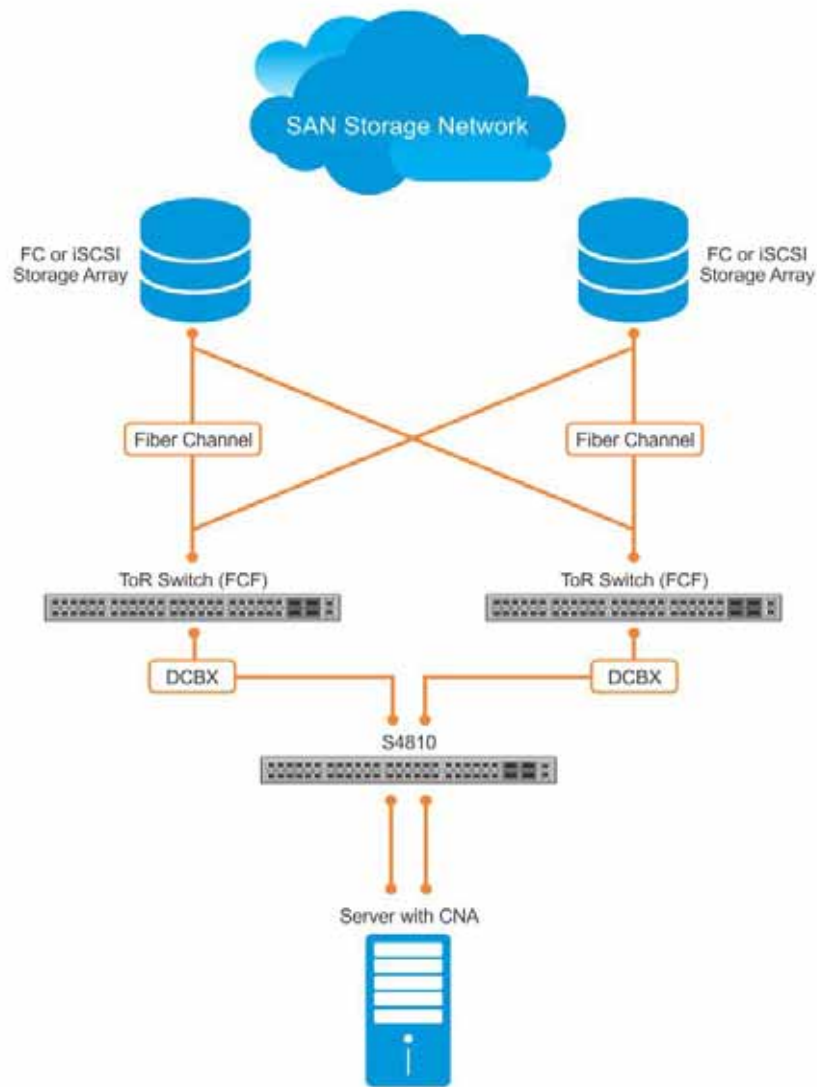

DCBx Prerequisites and Restrictions

The following prerequisites and restrictions apply when you configure DCBx operation on a port:

- DCBx requires LLDP in both send (TX) and receive (RX) mode to be enabled on a port interface (**protocol lldp mode** command; refer to the example in [CONFIGURATION versus INTERFACE Configurations](#) in the [Link Layer Discovery Protocol \(LLDP\)](#) chapter). If a multiple DCBx peer ports are detected on a local DCBx interface, LLDP is shut down.
- The CIN version of DCBx supports only PFC, ETS, and FCOE; it does not support iSCSI, backward congestion management (BCN), logical link down (LLDF), and network interface virtualization (NIV).

DCBx Configuration Procedure

To configure an S4810 or S4820T for DCBx operation in a data center network, you must:

1. Configure ToR- and FCF-facing interfaces as auto-upstream ports.
2. Configure server-facing interfaces as auto-downstream ports.
3. Configure a port to operate in a configuration-source role.
4. Configure ports to operate in a manual role.

To verify the DCBx configuration on a port, use the **show interface DCBx detail** command ([Figure 13-16](#)).

Configure DCBx operation at the interface level on a switch or globally on the switch.

Prerequisite: DCBx requires LLDP to be enabled to advertise DCBx TLVs to peers. For more information, refer to [Chapter 29, Link Layer Discovery Protocol \(LLDP\)](#).

Configuring DCBx on an Interface

To configure DCBx operation on an interface, follow these steps:

| Step | Task | Command | Command Mode |
|------|---|---------------------------------------|---------------|
| 1 | Enter INTERFACE Configuration mode. | <code>interface type slot/port</code> | CONFIGURATION |
| 2 | Enter LLDP Configuration mode to enable DCBx operation. | <code>[no] protocol lldp</code> | INTERFACE |

| Step | Task | Command | Command Mode |
|------|--|--|---------------|
| 3 | <p>Configure the DCBx version used on the interface, where: auto configures the port to operate using the DCBx version received from a peer.</p> <ul style="list-style-type: none"> • <code>cee</code> configures the port to use CEE (Intel 1.01). • <code>cin</code> configures the port to use Cisco-Intel-Nuova (DCBx 1.0). • <code>ieee-v2.5</code> configures the port to use IEEE 802.1Qaz (Draft 2.5). <p>Default: Auto.</p> | <code>[no] DCBx version {auto cee cin ieee-v2.5}</code> | PROTOCOL LLDP |
| 4 | <p>Configure the DCBx port role used by the interface to exchange DCB information, where:</p> <ul style="list-style-type: none"> • <code>auto-upstream</code> configures the port to receive a peer configuration. The configuration source is elected from auto-upstream ports. • <code>auto-downstream</code> configures the port to accept the internally propagated DCB configuration from a configuration source. • <code>config-source</code> configures the port to serve as the configuration source on the switch. • <code>manual</code> configures the port to operate only on administer-configured DCB parameters. The port does not accept a DCB configuration received from a peer or a local configuration source. <p>Default: Manual.</p> | <code>[no] DCBx port-role {config-source auto-downstream auto-upstream manual}</code> | PROTOCOL LLDP |
| 5 | <p>On manual ports only: Configure the PFC and ETS TLVs advertised to DCBx peers, where:</p> <ul style="list-style-type: none"> • <code>ets-conf</code> enables the advertisement of ETS Configuration TLVs. • <code>ets-reco</code> enables the advertisement of ETS Recommend TLVs. • <code>pfc</code> enables the advertisement of PFC TLVs. <p>Default: All PFC and ETS TLVs are advertised.</p> <p>Note: You can configure the transmission of more than one TLV type at a time; for example: <code>advertise DCBx-tlv ets-conf ets-reco</code>. You can enable ETS recommend TLVs (<code>ets-reco</code>) only if ETS configuration TLVs (<code>ets-conf</code>) are enabled. To disable TLV transmission, use the <code>no</code> form of the command; for example, <code>no advertise DCBx-tlv pfc ets-reco</code>.</p> | <code>[no] advertise DCBx-tlv {ets-conf ets-reco pfc} [ets-conf ets-reco pfc] [ets-conf ets-reco pfc]</code> | PROTOCOL LLDP |

| Step | Task | Command | Command Mode |
|------|--|---|---------------|
| 6 | <p>On manual ports only: Configure the Application Priority TLVs advertised on the interface to DCBx peers, where:</p> <ul style="list-style-type: none"> • fcoe enables the advertisement of FCoE in Application Priority TLVs. • iscsi enables the advertisement of iSCSI in Application Priority TLVs. <p>Default: Application Priority TLVs are enabled to advertise FCoE and iSCSI.</p> <p>Note: To disable TLV transmission, enter the no form of the command; for example, no advertise DCBx-appln-tlv iscsi.</p> <p>For information about how to use FCoE and iSCSI, refer to FIP Snooping and iSCSI Optimization.</p> | [no] advertise DCBx-appln-tlv {fcoe iscsi} | PROTOCOL LLDP |

Configuring DCBx Globally on the Switch

To globally configure DCBx operation on a switch, follow these steps:

| Step | Task | Command | Command Mode |
|------|---|--|----------------|
| 1 | Enter Global Configuration mode. | configure | EXEC PRIVILEGE |
| 2 | Enter LLDP Configuration mode to enable DCBx operation. | [no] protocol lldp | CONFIGURATION |
| 3 | <p>Configure the DCBx version used on all interfaces not already configured to exchange DCB information, where:</p> <ul style="list-style-type: none"> • auto configures all ports to operate using the DCBx version received from a peer. • cee configures a port to use CEE (Intel 1.01). cin configures a port to use Cisco-Intel-Nuova (DCBx 1.0). • ieee-v2.5 configures a port to use IEEE 802.1Qaz (Draft 2.5). <p>Default: Auto.</p> | [no] DCBx version {auto cee cin ieee-v2.5} | PROTOCL LLDP |

Note: You can configure the DCBx port role used by interfaces to exchange DCB information by using the **DCBx port-role** command in INTERFACE Configuration mode (see Step 3 in [Configuring DCBx Globally on the Switch](#)).

| Step | Task | Command | Command Mode |
|------|---|--|---------------|
| 4 | <p>Configure the PFC and ETS TLVs to be advertised on un-configured interfaces with a manual port-role, where:</p> <ul style="list-style-type: none"> ets-conf enables transmission of ETS Configuration TLVs. ets-reco enables transmission of ETS Recommend TLVs. pfcs enables transmission of PFC TLVs. <p>Note: You can configure the transmission of more than one TLV type at a time. ETS recommend TLVs (ets-reco) can be enabled only if ETS configuration TLVs (ets-conf) are enabled. To disable TLV transmission, use the no form of the command; for example, no advertise DCBx-tlv pfc ets-reco. Default: All TLV types are enabled.</p> | <pre>[no] advertise DCBx-tlv {ets-conf ets-reco pfc} [ets-conf ets-reco pfc] [ets-conf ets-reco pfc]</pre> | PROTOCOL LLDP |
| 5 | <p>Configure the Application Priority TLVs to be advertised on un-configured interfaces with a manual port-role, where:</p> <ul style="list-style-type: none"> fcoe enables the advertisement of FCoE in Application Priority TLVs. iscsi enables the advertisement of iSCSI in Application Priority TLVs. <p>Default: Application Priority TLVs are enabled and advertise FCoE and iSCSI. Note: To disable TLV transmission, use the no form of the command; for example, no advertise DCBx-appln-tlv iscsi.</p> <p>For information about how to use FCoE and iSCSI, refer to FIP Snooping and iSCSI Optimization.</p> | <pre>[no] advertise DCBx-appln-tlv {fcoe iscsi}</pre> | PROTOCOL LLDP |
| 6 | <p>Configure the FCoE priority advertised for the FCoE protocol in Application Priority TLVs. The priority-bitmap range is from 1 to FF. Default: 0x8.</p> | <pre>[no] fcoe priority-bits priority-bitmap</pre> | PROTOCOL LLDP |
| 7 | <p>Configure the iSCSI priority advertised for the iSCSI protocol in Application Priority TLVs. The priority-bitmap range is from 1 to FF. Default: 0x10.</p> | <pre>[no] iscsi priority-bits priority-bitmap</pre> | PROTOCOL LLDP |

DCBx Error Messages

An error in DCBx operation is displayed using the syslog messages:

LLDP_MULTIPLE_PEER_DETECTED: DCBx is operationally disabled after detecting more than one DCBx peer on the port interface.

LLDP_PEER_AGE_OUT: DCBx is disabled as a result of LLDP timing out on a DCBx peer interface.

DSM_DCBx_PEER_VERSION_CONFLICT: A local port expected to receive the IEEE, CIN, or CEE version in a DCBx TLV from a remote peer but received a different, conflicting DCBx version.

DSM_DCBx_PFC_PARAMETERS_MATCH and **DSM_DCBx_PFC_PARAMETERS_MISMATCH:** A local DCBx port received a compatible (match) or incompatible (mismatch) PFC configuration from a peer.

DSM_DCBx_ETS_PARAMETERS_MATCH and **DSM_DCBx_ETS_PARAMETERS_MISMATCH:** A local DCBx port received a compatible (match) or incompatible (mismatch) ETS configuration from a peer.

LLDP_UNRECOGNISED_DCBx_TLV_RECEIVED: A local DCBx port received an unrecognized DCBx TLV from a peer.

Debugging DCBx on an Interface

To enable DCBx debug traces for all or a specific control path, use the following command:

| Task | Command | Command Mode |
|---|--|----------------|
| Enable DCBx debugging, where: <ul style="list-style-type: none"> all: Enables all DCBx debugging operations. auto-detect-timer: Enables traces for DCBx auto-detect timers. config-exchng: Enables traces for DCBx configuration exchanges. fail: Enables traces for DCBx failures. mgmt: Enables traces for DCBx management frames. resource: Enables traces for DCBx system resource frames. sem: Enables traces for the DCBx state machine. tlv: Enables traces for DCBx TLVs. | <code>debug DCBx {all auto-detect-timer config-exchng fail mgmt resource sem tlv}</code> | EXEC PRIVILEGE |

Verifying DCB Configuration

Use the **show** commands in [Table 13-2](#) to display DCB configurations.

Table 13-2. Displaying DCB Configurations

| Command | Output |
|---|---|
| show dot1p-queue mapping | Displays the current 802.1p priority-queue mapping. |
| show dcb [stack-unit <i>unit-number</i>] | Displays data center bridging status, number of PFC-enabled ports, and number of PFC-enabled queues. On the master switch in a stack, you can specify a stack-unit number. Range is : 0 to 5. |
| show qos dcb-input [pfc-profile] | Displays the PFC configuration in a DCB input policy. |
| show qos dcb-output [ets-profile] | Displays the ETS configuration in a DCB output policy. |
| show qos priority-groups | Displays the ETS priority groups configured on the switch, including the 802.1p priority classes and ID of each group. |
| show interface <i>port-type slot/port</i> pfc {summary detail} | Displays the PFC configuration applied to ingress traffic on an interface, including priorities and link delay. To clear PFC TLV counters, use the <code>clear pfc counters interface <i>port-type slot/port</i></code> command. |
| show interface <i>port-type slot/port</i> pfc statistics | Displays counters for the PFC frames received and transmitted (by dot1p priority class) on an interface. |
| show interface <i>port-type slot/port</i> ets {summary detail} | Displays the ETS configuration applied to egress traffic on an interface, including priority groups with priorities and bandwidth allocation. To clear ETS TLV counters, enter the <code>clear ets counters interface <i>port-type slot/port</i></code> command. |
| show interface <i>port-type slot/port</i> DCBx detail | Displays the DCBx configuration on an interface. |
| show stack-unit {0-11 all} stack ports all pfc details | Displays the PFC configuration applied to ingress traffic on stack-links, including priorities and link delay. |
| show stack-unit {0-11 all} stack ports all ets details | Displays the ETS configuration applied to ingress traffic on stack-links, including priorities and link delay. |

Figure 13-5. show dot1p-queue mapping Command Example

```
FTOS(conf)# show dot1p-queue-mapping
Dot1p Priority: 0 1 2 3 4 5 6 7
Queue          : 0 0 0 1 2 3 3 3
```

Figure 13-6. show dcb Command Example

```
FTOS# show dcb
stack-unit 0 port-set 0
  DCB Status : Enabled
  PFC Port Count : 56 (current), 56 (configured)
  PFC Queue Count : 2 (current), 2 (configured)
```

Figure 13-7. show qos dcb-input Command Example

```
FTOS(conf)# show qos dcb-input
dcb-input pfc-profile
  pfc link-delay 32
  pfc priority 0-1
dcb-input pfc-profile1
  no pfc mode on
  pfc priority 6-7
```

Figure 13-8. show qos dcb-output Command Example

```
FTOS# show qos dcb-output
dcb-output ets
  priority-group san qos-policy san
  priority-group ipc qos-policy ipc
  priority-group lan qos-policy lan
```

Figure 13-9. show qos priority-groups Command Example

```
FTOS#show qos priority-groups
priority-group ipc
  priority-list 4
  set-pgid 2
```

Figure 13-10. show interfaces pfc summary Command Example

```

FTOS# show interfaces tengigabitethernet 0/49 pfc summary
Interface TenGigabitEthernet 0/49
  Admin mode is on
  Admin is enabled
  Remote is enabled, Priority list is 4
  Remote Willing Status is enabled
  Local is enabled
  Oper status is Recommended
  PFC DCBx Oper status is Up
  State Machine Type is Feature
  TLV Tx Status is enabled
  PFC Link Delay 45556 pause quantams
  Application Priority TLV Parameters :
  -----
  FCOE TLV Tx Status is disabled
  ISCSI TLV Tx Status is disabled
  Local FCOE PriorityMap is 0x8
  Local ISCSI PriorityMap is 0x10
  Remote FCOE PriorityMap is 0x8
  Remote ISCSI PriorityMap is 0x8

FTOS# show interfaces tengigabitethernet 0/49 pfc detail
Interface TenGigabitEthernet 0/49
  Admin mode is on
  Admin is enabled
  Remote is enabled
  Remote Willing Status is enabled
  Local is enabled
  Oper status is recommended
  PFC DCBx Oper status is Up
  State Machine Type is Feature
  TLV Tx Status is enabled
  PFC Link Delay 45556 pause quanta
  Application Priority TLV Parameters :
  -----
  FCOE TLV Tx Status is disabled
  ISCSI TLV Tx Status is disabled
  Local FCOE PriorityMap is 0x8
  Local ISCSI PriorityMap is 0x10
  Remote FCOE PriorityMap is 0x8
  Remote ISCSI PriorityMap is 0x8

0 Input TLV pkts, 1 Output TLV pkts, 0 Error pkts, 0 Pause Tx pkts, 0 Pause Rx pkts

```

Table 13-3. show interface pfc summary Command Description

| Field | Description |
|--------------------------------------|--|
| Interface | Interface type with stack-unit and port number. |
| Admin mode is on Admin is enabled | PFC Admin mode is on or off with a list of the configured PFC priorities. When PFC admin mode is on, PFC advertisements are enabled to be sent and received from peers; received PFC configuration takes effect. The admin operational status for a DCBx exchange of PFC configuration is enabled or disabled. |

Table 13-3. show interface pfc summary Command Description

| Field | Description |
|---|---|
| Remote is enabled, Priority list Remote Willing Status is enabled | Operational status (enabled or disabled) of peer device for DCBx exchange of PFC configuration with a list of the configured PFC priorities. Willing status of peer device for DCBx exchange (Willing bit received in PFC TLV): enabled or disabled. |
| Local is enabled | DCBx operational status (enabled or disabled) with a list of the configured PFC priorities. |
| Operational status (local port) | Port state for current operational PFC configuration: Init: Local PFC configuration parameters were exchanged with peer. Recommend: Remote PFC configuration parameters were received from peer. Internally propagated: PFC configuration parameters were received from configuration source. |
| PFC DCBx Oper status | Operational status for exchange of PFC configuration on local port: match (up) or mismatch (down). |
| State Machine Type | Type of state machine used for DCBx exchanges of PFC parameters: Feature - for legacy DCBx versions; Symmetric - for an IEEE version. |
| TLV Tx Status | Status of PFC TLV advertisements: enabled or disabled. |
| PFC Link Delay | Link delay (in quanta) used to pause specified priority traffic. |
| Application Priority TLV: FCOE TLV Tx Status | Status of FCoE advertisements in application priority TLVs from local DCBx port: enabled or disabled. |
| Application Priority TLV: ISCSI TLV Tx Status | Status of iSCSI advertisements in application priority TLVs from local DCBx port: enabled or disabled. |
| Application Priority TLV: Local FCOE Priority Map | Priority bitmap used by local DCBx port in FCoE advertisements in application priority TLVs. |
| Application Priority TLV: Local ISCSI Priority Map | Priority bitmap used by local DCBx port in iSCSI advertisements in application priority TLVs. |
| Application Priority TLV: Remote FCOE Priority Map | Status of FCoE advertisements in application priority TLVs from remote peer port: enabled or disabled. |
| Application Priority TLV: Remote ISCSI Priority Map | Status of iSCSI advertisements in application priority TLVs from remote peer port: enabled or disabled. |
| PFC TLV Statistics: Input TLV pkts | Number of PFC TLVs received. |
| PFC TLV Statistics: Output TLV pkts | Number of PFC TLVs transmitted. |
| PFC TLV Statistics: Error pkts | Number of PFC error packets received. |
| PFC TLV Statistics: Pause Tx pkts | Number of PFC pause frames transmitted. |

Table 13-3. show interface pfc summary Command Description

| Field | Description |
|--------------------------------------|-------------------------------------|
| PFC TLV Statistics: Pause Rx pkts | Number of PFC pause frames received |

Figure 13-11. show interface pfc statistics Command Example

```
FTOS#show interfaces te 0/0 pfc statistics
Interface TenGigabitEthernet 0/0
Priority Received PFC Frames Transmitted PFC Frames
-----
0          0                0
1          0                0
2          0                0
3          0                0
4          0                0
5          0                0
6          0                0
7          0                0
```

Figure 13-12. show interface ets summary Command Example

```

FTOS(conf-qos-policy-out-ets)#do sho int te 0/3 ets de

Interface TenGigabitEthernet 0/3
Max Supported TC Groups is 4
Number of Traffic Classes is 8
Admin mode is on

Admin Parameters :
-----
Admin is enabled

TC-grp      Priority#      Bandwidth      TSA
-----
0           -              -              -
1           0,1,2         100%           ETS
2           3              0 %            SP
3           4,5,6,7       0 %            SP
4           -              -              -
5           -              -              -
6           -              -              -
7           -              -              -

Remote Parameters :
-----
Remote is disabled

Local Parameters :
-----
Local is enabled

TC-grp      Priority#      Bandwidth      TSA
-----
0           -              -              -
1           0,1,2         100%           ETS
2           3              0 %            SP
3           4,5,6,7       0 %            SP
4           -              -              -
5           -              -              -
6           -              -              -
7           -              -              -

Oper status is init
ETS DCBx Oper status is Down
State Machine Type is Asymmetric
Conf TLV Tx Status is enabled
Reco TLV Tx Status is enabled

0 Input Conf TLV Pkts, 1955 Output Conf TLV Pkts, 0 Error Conf TLV Pkts
0 Input Reco TLV Pkts, 1955 Output Reco TLV Pkts, 0 Error Reco TLV Pkts

```

```

FTOS(conf)# show interfaces tengigabitethernet 0/0 ets detail
Interface TenGigabitEthernet 0/0
Max Supported TC Groups is 4
Number of Traffic Classes is 8
Admin mode is on
Admin Parameters :
-----
Admin is enabled
TC-grp Priority# Bandwidth TSA
0 0,1,2,3,4,5,6,7 100% ETS
1 0% ETS
2 0% ETS
3 0% ETS
4 0% ETS
5 0% ETS
6 0% ETS
7 0% ETS
Priority# Bandwidth TSA
0 13% ETS
1 13% ETS
2 13% ETS
3 13% ETS
4 12% ETS
5 12% ETS
6 12% ETS
7 12% ETS
Remote Parameters:
-----
Remote is disabled
Local Parameters :
-----
Local is enabled
TC-grp Priority# Bandwidth TSA
0 0,1,2,3,4,5,6,7 100% ETS
1 0% ETS
2 0% ETS
3 0% ETS
4 0% ETS
5 0% ETS
6 0% ETS
7 0% ETS
Priority# Bandwidth TSA
0 13% ETS
1 13% ETS
2 13% ETS
3 13% ETS
4 12% ETS
5 12% ETS
6 12% ETS
7 12% ETS
Oper status is init
Conf TLV Tx Status is disabled
Traffic Class TLV Tx Status is disabled
0 Input Conf TLV Pkts, 0 Output Conf TLV Pkts, 0 Error Conf TLV Pkts
0T LIVnput Traffic Class TLV Pkts, 0 Output Traffic Class TLV Pkts, 0 Error Traffic Class
Pkts

```

Figure 13-13. show interface ets detail Command Example

```

FTOS(conf)# show interfaces tengigabitethernet 0/0 ets detail
Interface TenGigabitEthernet 0/0
Max Supported TC Groups is 4
Number of Traffic Classes is 8
Admin mode is on
Admin Parameters :
-----
Admin is enabled
TC-grp   Priority#       Bandwidth      TSA
0         0,1,2,3,4,5,6,7   100%           ETS
1         0%                 ETS
2         0%                 ETS
3         0%                 ETS
4         0%                 ETS
5         0%                 ETS
6         0%                 ETS
7         0%                 ETS

Priority#           Bandwidth      TSA
0                   13%           ETS
1                   13%           ETS
2                   13%           ETS
3                   13%           ETS
4                   12%           ETS
5                   12%           ETS
6                   12%           ETS
7                   12%           ETS

Remote Parameters:
-----
Remote is disabled

Local Parameters :
-----
Local is enabled
TC-grp   Priority#       Bandwidth      TSA
0         0,1,2,3,4,5,6,7   100%           ETS
1         0%                 ETS
2         0%                 ETS
3         0%                 ETS
4         0%                 ETS
5         0%                 ETS
6         0%                 ETS
7         0%                 ETS

Priority#           Bandwidth      TSA
0                   13%           ETS
1                   13%           ETS
2                   13%           ETS
3                   13%           ETS
4                   12%           ETS
5                   12%           ETS
6                   12%           ETS
7                   12%           ETS

Oper status is init
Conf TLV Tx Status is disabled
Traffic Class TLV Tx Status is disabled
0 Input Conf TLV Pkts, 0 Output Conf TLV Pkts, 0 Error Conf TLV Pkts
0 Input Traffic Class TLV Pkts, 0 Output Traffic Class TLV Pkts, 0 Error Traffic Class TLV
Pkts

```

Table 13-4. show interface ets detail Command Description

| Field | Description |
|--|--|
| Interface | Interface type with stack-unit and port number. |
| Max Supported TC Group | Maximum number of priority groups supported. |
| Number of Traffic Classes | Number of 802.1p priorities currently configured. |
| Admin mode | ETS mode: on or off. When on, the scheduling and bandwidth allocation configured in an ETS output policy or received in a DCBx TLV from a peer can take effect on an interface. |
| Admin Parameters | ETS configuration on local port, including priority groups, assigned dot1p priorities, and bandwidth allocation. |
| Remote Parameters | ETS configuration on remote peer port, including Admin mode (enabled if a valid TLV was received or disabled), priority groups, assigned dot1p priorities, and bandwidth allocation. If the ETS Admin mode is enabled on the remote port for DCBx exchange, the Willing bit received in ETS TLVs from the remote peer is included. |
| Local Parameters | ETS configuration on local port, including Admin mode (enabled when a valid TLV is received from a peer), priority groups, assigned dot1p priorities, and bandwidth allocation. |
| Operational status (local port) | Port state for current operational ETS configuration: Init: Local ETS configuration parameters were exchanged with peer. Recommend: Remote ETS configuration parameters were received from peer. Internally propagated: ETS configuration parameters were received from configuration source. |
| ETS DCBx Oper status | Operational status of ETS configuration on local port: match or mismatch. |
| State Machine Type | Type of state machine used for DCBx exchanges of ETS parameters: Feature - for legacy DCBx versions; Asymmetric - for an IEEE version. |
| Conf TLV Tx Status | Status of ETS Configuration TLV advertisements: enabled or disabled. |
| ETS TLV Statistic: Input Conf TLV pkts | Number of ETS Configuration TLVs received. |
| ETS TLV Statistic: Output Conf TLV pkts | Number of ETS Configuration TLVs transmitted. |
| ETS TLV Statistic: Error Conf TLV pkts | Number of ETS Error Configuration TLVs received. |

Figure 13-14. show stack-unit all stack-ports all pfc details Command Example

```

FTOS(conf)# show stack-unit all stack-ports all pfc details

stack unit 0 stack-port all
  Admin mode is On
  Admin is enabled, Priority list is 4-5
  Local is enabled, Priority list is 4-5
  Link Delay 45556 pause quantum
  0 Pause Tx pkts, 0 Pause Rx pkts

stack unit 1 stack-port all
  Admin mode is On
  Admin is enabled, Priority list is 4-5
  Local is enabled, Priority list is 4-5
  Link Delay 45556 pause quantum
  0 Pause Tx pkts, 0 Pause Rx pkts

```

Figure 13-15. show stack-unit all stack-ports all ets details Command Example

```

FTOS(conf)# show stack-unit all stack-ports all ets details

Stack unit 0 stack port all
Max Supported TC Groups is 4
Number of Traffic Classes is 1
Admin mode is on

Admin Parameters:
-----
Admin is enabled
TC-grp      Priority#      Bandwidth      TSA
-----
0           0,1,2,3,4,5,6,7  100%           ETS
1           -               -               -
2           -               -               -
3           -               -               -
4           -               -               -
5           -               -               -
6           -               -               -
7           -               -               -
8           -               -               -

Stack unit 1 stack port all
Max Supported TC Groups is 4
Number of Traffic Classes is 1
Admin mode is on
Admin Parameters:
-----
Admin is enabled
TC-grp      Priority#      Bandwidth      TSA
-----
0           0,1,2,3,4,5,6,7  100%           ETS
1           -               -               -
2           -               -               -
3           -               -               -
4           -               -               -
5           -               -               -
6           -               -               -
7           -               -               -
8           -               -               -

```

Figure 13-16. show interface DCBx detail for ieee Command Example

```
FTOS(conf-if-te-0/17-lldp)#do sho int te 2/12 dc d

E-ETS Configuration TLV enabled           e-ETS Configuration TLV disabled
R-ETS Recommendation TLV enabled         r-ETS Recommendation TLV disabled
P-PFC Configuration TLV enabled         p-PFC Configuration TLV disabled
F-Application priority for FCOE enabled  f-Application Priority for FCOE disabled
I-Application priority for iSCSI enabled  i-Application Priority for iSCSI disabled
-----

Interface TenGigabitEthernet 2/12
  Remote Mac Address 00:01:e8:8a:df:a0
  Port Role is Manual
  DCBx Operational Status is Enabled
  Is Configuration Source? FALSE
  Local DCBx Compatibility mode is IEEEv2.5
  Local DCBx Configured mode is IEEEv2.5
  Peer Operating version is IEEEv2.5
  Local DCBx TLVs Transmitted: ERPFi
  1 Input PFC TLV pkts, 2 Output PFC TLV pkts, 0 Error PFC pkts
  0 PFC Pause Tx pkts, 0 Pause Rx pkts
  1 Input ETS Conf TLV Pkts, 1 Output ETS Conf TLV Pkts, 0 Error ETS Conf TLV Pkts
  1 Input ETS Reco TLV pkts, 1 Output ETS Reco TLV pkts, 0 Error ETS Reco TLV Pkts
```

Figure 13-17. show interface DCBx detail for legacy cee Command Example

```

FTOS(conf-if-te-0/17-lldp)#do sho int te 1/14 dc d

E-ETS Configuration TLV enabled           e-ETS Configuration TLV disabled
R-ETS Recommendation TLV enabled         r-ETS Recommendation TLV disabled
P-PFC Configuration TLV enabled         p-PFC Configuration TLV disabled
F-Application priority for FCOE enabled  f-Application Priority for FCOE disabled
I-Application priority for iSCSI enabled i-Application Priority for iSCSI disabled
-----

Interface TenGigabitEthernet 1/14
  Remote Mac Address 00:01:e8:8a:df:a0
  Port Role is Auto-Upstream
  DCBx Operational Status is Enabled
  Is Configuration Source? FALSE
  Local DCBx Compatibility mode is CEE
  Local DCBx Configured mode is CEE
  Peer Operating version is CEE
  Local DCBx TLVs Transmitted: ErPFI

Local DCBx Status
-----
  DCBx Operational Version is 0
  DCBx Max Version Supported is 0
  Sequence Number: 1
  Acknowledgment Number: 1
  Protocol State: In-Sync

Peer DCBx Status:
-----
  DCBx Operational Version is 0
  DCBx Max Version Supported is 0
  Sequence Number: 1
  Acknowledgment Number: 1
  Total DCBx Frames transmitted 994
  Total DCBx Frames received 646
  Total DCBx Frame errors 0
  Total DCBx Frames unrecognized 0

```

Table 13-5. show interface DCBx detail Command Description

| Field | Description |
|-------------------------|---|
| Interface | Interface type with chassis slot and port number. |
| Port-Role | Configured DCBx port role: auto-upstream, auto-downstream, config-source, or manual. |
| DCBx Operational Status | Operational status (enabled or disabled) used to elect a configuration source and internally propagate a DCB configuration. The DCBx operational status is the combination of PFC and ETS operational status. |
| Configuration Source | Specifies whether the port serves as the DCBx configuration source on the switch: true (yes) or false (no). |

Table 13-5. show interface DCBx detail Command Description

| Field | Description |
|--|--|
| Local DCBx Compatibility mode | DCBx version accepted in a DCB configuration as compatible. In auto-upstream mode, a port can only received a DCBx version supported on the remote peer. |
| Local DCBx Configured mode | DCBx version configured on the port: CEE, CIN, IEEE v2.5, or Auto (port auto-configures to use the DCBx version received from a peer). |
| Peer Operating version | DCBx version that the peer uses to exchange DCB parameters. |
| Local DCBx TLVs Transmitted | Transmission status (enabled or disabled) of advertised DCB TLVs (see TLV code at the top of the show command output). |
| Local DCBx Status: DCBx Operational Version | DCBx version advertised in Control TLVs. |
| Local DCBx Status: DCBx Max Version Supported | Highest DCBx version supported in Control TLVs. |
| Local DCBx Status: Sequence Number | Sequence number transmitted in Control TLVs. |
| Local DCBx Status: Acknowledgment Number | Acknowledgement number transmitted in Control TLVs |
| Local DCBx Status: Protocol State | Current operational state of DCBx protocol: ACK or IN-SYNC. |
| Peer DCBx Status: DCBx Operational Version | DCBx version advertised in Control TLVs received from peer device. |
| Peer DCBx Status: DCBx Max Version Supported | Highest DCBx version supported in Control TLVs received from peer device. |
| Peer DCBx Status: Sequence Number | Sequence number transmitted in Control TLVs received from peer device. |
| Peer DCBx Status: Acknowledgment Number | Acknowledgement number transmitted in Control TLVs received from peer device. |
| Total DCBx Frames transmitted | Number of DCBx frames sent from local port. |
| Total DCBx Frames received | Number of DCBx frames received from remote peer port. |
| Total DCBx Frame errors | Number of DCBx frames with errors received. |
| Total DCBx Frames unrecognized | Number of unrecognizable DCBx frames received. |

PFC and ETS Configuration Examples

This section contains examples of how to configure and apply DCB input and output policies on an interface.

Using PFC and ETS to Manage Data Center Traffic

In the following example:

- Incoming SAN traffic is configured for priority-based flow control.
- Outbound LAN, IPC, and SAN traffic is mapped into three ETS priority groups and configured for enhanced traffic selection (bandwidth allocation and scheduling).
- One lossless queue is used.

Figure 13-18. Example: PFC and ETS Applied to LAN, IPC, and SAN Priority Traffic

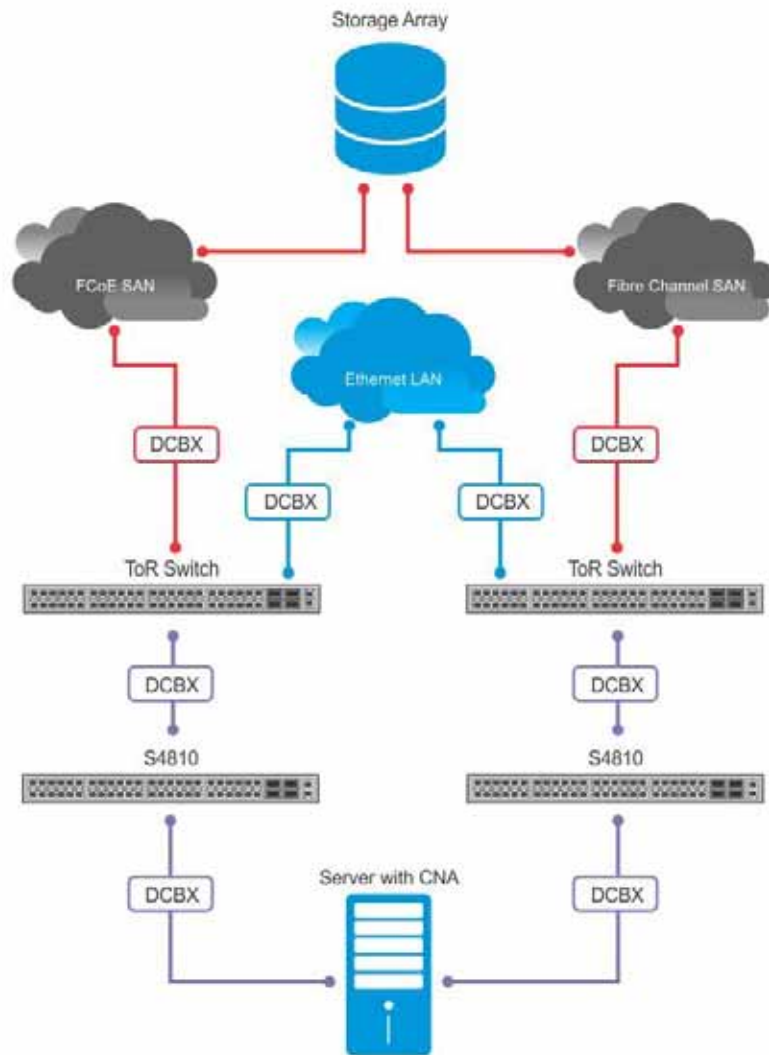

QoS Traffic Classification: The service-class dynamic dot1p command has been used in Global Configuration mode to map ingress dot1p frames to the queues shown in [Table 13-6](#). For more information, refer to [QoS dot1p Traffic Classification and Queue Assignment](#).

Table 13-6. Example: dot1p-Queue Assignment

| dot1p Value in Incoming Frame | Queue Assignment |
|-------------------------------|------------------|
| 0 | 0 |
| 1 | 0 |
| 2 | 0 |
| 3 | 1 |
| 4 | 2 |
| 5 | 3 |
| 6 | 3 |
| 7 | 3 |

Lossless SAN traffic with dot1p priority 3 is assigned to queue 1. Other traffic types are assigned the 802.1p priorities shown in [Table 13-7](#) and the bandwidth allocations shown in [Table 13-8](#).

Table 13-7. Example: dot1p-priority class group Assignment

| dot1p Value in Incoming Frame | Priority Group Assignment |
|-------------------------------|---------------------------|
| 0 | LAN |
| 1 | LAN |
| 2 | LAN |
| 3 | SAN |
| 4 | IPC |
| 5 | LAN |
| 6 | LAN |
| 7 | LAN |

Table 13-8. Example: priority group-bandwidth Assignment

| Priority Group | Bandwidth Assignment |
|----------------|----------------------|
| IPC | 5% |
| SAN | 50% |
| LAN | 45% |

Figure 13-19. PFC and ETS Configuration Command Example

Configure QoS priority-queue assignment to honor dot1p priorities or use L2 class maps to mark and map ingress traffic to output queues; for example:

```
FTOS(conf)# service-class dynamic dot1p
```

Or

```
FTOS(conf)# interface tengigabitethernet 0/1  
FTOS(conf-if-te-0/1)# service-class dynamic dot1p
```

Configure a DCB input policy for applying PFC to lossless SAN priority traffic:

```
FTOS(conf)# dcb-input ipc_san_lan  
FTOS(conf-qos-policy-in)# pfc mode on  
FTOS(conf-qos-policy-in)# pfc priority 3
```

Configure an ETS priority group:

```
FTOS(conf)# priority-group san  
FTOS(conf-pg)# priority-list 3  
FTOS(conf-pg)# set-pgid 1  
FTOS(conf-pg)# exit  
FTOS(conf)# priority-group ipc  
FTOS(conf-pg)# priority-list 4  
FTOS(conf-pg)# set-pgid 2  
FTOS(conf-pg)# exit  
FTOS(conf)# priority-group lan  
FTOS(conf-pg)# priority-list 0-2,5-7  
FTOS(conf-pg)# set-pgid 3  
FTOS(conf-pg)# exit
```

Configure an ETS output policy for egress traffic:

```
FTOS(conf)# qos-policy-output san ets  
FTOS(conf-qos-policy-out)# bandwidth-percentage 50  
FTOS(conf-qos-policy-out)# exit  
FTOS(conf)# qos-policy-output lan ets  
FTOS(conf-qos-policy-out)# bandwidth-percentage 45  
FTOS(conf-qos-policy-out)# exit  
FTOS(conf)# qos-policy-output ipc ets  
FTOS(conf-qos-policy-out)# bandwidth-percentage 5  
FTOS(conf-qos-policy-out)# exit
```

Figure 13-20. Example: DCB PFC and ETS Configuration (Continued)

Configure a DCB output policy for applying ETS (bandwidth allocation and scheduling) to IPC, SAN, and LAN priority traffic:

```
FTOS(conf)# dcb-output ets
FTOS(conf-dcb-out)# priority-group san qos-policy san
FTOS(conf-dcb-out)# priority-group lan qos-policy lan
FTOS(conf-dcb-out)# priority-group ipc qos-policy ipc
```

Apply DCB input and output policies to a port interface:

```
FTOS(conf)# interface tengigabitethernet 0/1
FTOS(conf-if-te-0/1)# dcb-policy input pfc
FTOS(conf-if-te-0/1)# dcb-policy output ets
```

If the DCBx version is CIN, configure a QoS output policy to specify bandwidth allocation to different traffic types:

```
FTOS(conf)# qos-policy-output lan-q0
FTOS(conf-qos-policy-out)# bandwidth-percentage 20
FTOS(conf-qos-policy-out)# exit
FTOS(conf)# qos-policy-output lan-q3
FTOS(conf-qos-policy-out)# bandwidth-percentage 70
FTOS(conf-qos-policy-out)# exit
FTOS(conf)#policy-map-output ets-queues
```

Create a QoS policy map for DCBx CIN bandwidth allocation:

```
FTOS(conf)# policy-map-output ets-queues
FTOS(conf-policy-map-out)# service-queue 0 qos-policy lan-q0
FTOS(conf-policy-map-out)# service-queue 3 qos-policy lan-q3
```

Apply the QoS policy map for DCBx CIN bandwidth allocation to an interface:

```
FTOS(conf-if-te-0/1)# service-policy output ets-queues
```

Using PFC and ETS to Manage Converged Ethernet Traffic in a Switch Stack

Figure 13-21 shows how to apply the DCB PFC input policy (ipc_san_lan) and ETS output policy (ets) configured in Figure 13-19 and Figure 13-20 on all ports in a switch stack.

Figure 13-21. Apply DCB PFC Input Policy and ETS Output Policy in a Switch Stack Example

On the stack master, apply DCB PFC input and ETS output policies to all port interfaces on stacked switches:

```
FTOS(conf)# dcb-policy output stack-unit all stack-ports all ets
FTOS(conf)# dcb-policy input stack-unit all stack-ports all pfc
```

Hierarchical Scheduling in ETS Output Policies

ETS supports up to three levels of hierarchical scheduling. For example, you can apply ETS output policies with the following configurations:

- Priority group 1 assigns traffic to one priority queue with 20% of the link bandwidth and strict-priority scheduling.
- Priority group 2 assigns traffic to one priority queue with 30% of the link bandwidth.
- Priority group 3 assigns traffic to two priority queues with 50% of the link bandwidth and strict-priority scheduling.

In this example, the configured ETS bandwidth allocation and scheduler behavior is as follows:

- Unused bandwidth usage: Normally, if there is no traffic or unused bandwidth for a priority group, the bandwidth allocated to the group is distributed to the other priority groups according to the bandwidth percentage allocated to each group. However, when three priority groups with different bandwidth allocations are used on an interface:
 - If priority group 3 has free bandwidth, it is distributed as follows: 20% of the free bandwidth to priority group 1 and 30% of the free bandwidth to priority group 2.
 - If priority group 1 or 2 has free bandwidth, (20 + 30)% of the free bandwidth is distributed to priority group 3. Priority groups 1 and 2 retain whatever free bandwidth remains up to the (20+30)%.
- Strict-priority groups: If two priority groups have strict-priority scheduling, traffic assigned from the priority group with the higher priority-queue number is scheduled first. However, when three priority groups are used and two groups have strict-priority scheduling (such as groups 1 and 3 in the example), the strict priority group whose traffic is mapped to one queue takes precedence over the strict priority group whose traffic is mapped to two queues.

Therefore, in the example, scheduling traffic to priority group 1 (mapped to one strict-priority queue) takes precedence over scheduling traffic to priority group 3 (mapped to two strict-priority queues).

Dynamic Host Configuration Protocol (DHCP)

Dynamic Host Configuration Protocol (DHCP) is available on platforms: e c s **S4810** **S4820T** Z .

This chapter contains the following sections:

- [Protocol Overview](#)
- [Implementation Information](#)
- [Configuration Tasks](#)
- [Configure the System to be a DHCP Server](#)
- [Configure the System to be a Relay Agent](#)
- [Configure the System for User Port Stacking](#)
- [Configure Secure DHCP](#)

Protocol Overview

Dynamic Host Configuration Protocol (DHCP) is an application layer protocol that dynamically assigns IP addresses and other configuration parameters to network end-stations (hosts) based on configuration policies determined by network administrators. DHCP:

- relieves network administrators of manually configuring hosts, which is a can be a tedious and error-prone process when hosts often join, leave, and change locations on the network.
- reclaims IP addresses that are no longer in use to prevent address exhaustion.

DHCP is based on a client-server model. A host discovers the DHCP server and requests an IP address, and the server either leases or permanently assigns one. There are three types of devices that are involved in DHCP negotiation:

- **DHCP Server**—a network device offering configuration parameters to the client
- **DHCP Client**—a network device requesting configuration parameters from the server
- **Relay agent**—an intermediary network device that passes DHCP messages between the client and server when the server is not on the same subnet as the host

DHCP Packet Format and Options

DHCP uses UDP as its transport protocol. The server listens on port 67 and transmits to port 68; the client listens on port 68 and transmits to port 67. The configuration parameters are carried as options in the DHCP packet in Type, Length, Value (TLV) format; many options are specified in RFC 2132. To limit the number of parameters that servers must provide, hosts specify the parameters that they require, and the server sends only those; some common options are given in [Table 14-1](#).

Figure 14-1. DHCP Packet Format



Table 14-1. Common DHCP Options

| Option | Code | Description |
|------------------------|------|---|
| Subnet Mask | 1 | Specifies the client's subnet mask. |
| Router | 3 | Specifies the router IP addresses that may serve as the client's default gateway. |
| Domain Name Server | 6 | Specifies the DNS servers that are available to the client. |
| Domain Name | 15 | Specifies the domain name that clients should use when resolving hostnames via DNS. |
| IP Address Lease Time | 51 | Specifies the amount of time that the client is allowed to use an assigned IP address. |
| DHCP Message Type | 53 | 1: DHCPDISCOVER 2: DHCPOFFER 3: DHCPREQUEST 4: DHCPDECLINE 5: DHCPACK 6: DHCPNACK 7: DHCPRELEASE 8: DHCPINFORM |
| Parameter Request List | 55 | Clients use this option to tell the server which parameters it requires. It is a series of octets where each octet is DHCP option code. |
| Renewal Time | 58 | Specifies the amount of time after the IP address is granted that the client attempts to renew its lease with the <i>original</i> server. |
| Rebinding Time | 59 | Specifies the amount of time after the IP address is granted that the client attempts to renew its lease with <i>any</i> server, if the original server does not respond. |
| End | 255 | Signals the last option in the DHCP packet. |

Assigning an IP Address using DHCP

When a client joins a network:

1. The client initially broadcasts a **DHCPDISCOVER** message on the subnet to discover available DHCP servers. This message includes the parameters that the client requires and might include suggested values for those parameters.
2. Servers unicast or broadcast a **DHCPOFFER** message in response to the DHCPDISCOVER that offers to the client values for the requested parameters. Multiple servers might respond to a single DHCPDISCOVER; the client might wait a period of time and then act on the most preferred offer.
3. The client broadcasts a **DHCPREQUEST** message in response to the offer, requesting the offered values.
4. Upon receiving a DHCPREQUEST, the server binds the clients' unique identifier (the hardware address plus IP address) to the accepted configuration parameters and stores the data in a database called a *binding table*. The server then broadcasts a **DHCPACK** message, which signals to the client that it may begin using the assigned parameters.
5. When the client leaves the network, or the lease time expires, returns its IP address to the server in a **DHCPRELEASE** message.

There are additional messages that are used in case the DHCP negotiation deviates from the process previously described and shown in the illustration below.

- **DHCPDECLINE**—A client sends this message to the server in response to a DHCPACK if the configuration parameters are unacceptable, for example, if the offered address is already in use. In this case, the client starts the configuration process over by sending a DHCPDISCOVER.
- **DHCPINFORM**—A client uses this message to request configuration parameters when it assigned an IP address manually rather than with DHCP. The server responds by unicast.
- **DHCPNAK**—A server sends this message to the client if it is not able to fulfill a DHCPREQUEST, for example if the requested address is already in use. In this case, the client starts the configuration process over by sending a DHCPDISCOVER.

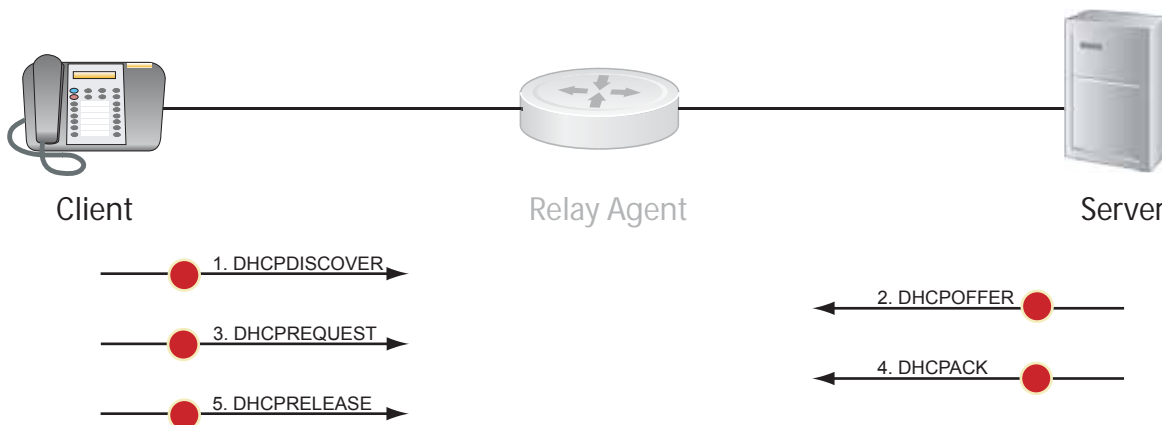

Implementation Information

- The Dell Force10 implementation of DHCP is based on RFC 2131 and RFC 3046.
- IP Source Address Validation is a sub-feature of DHCP Snooping; FTOS uses ACLs internally to implement this feature and as such, you cannot apply ACLs to an interface which has IP Source Address Validation. If you configure IP Source Address Validation on a member port of a VLAN and then attempt to apply a access list to the VLAN, FTOS displays the first line in [Message 1](#). If you first apply an ACL to a VLAN and then attempt enable IP Source Address Validation on one of its member ports, FTOS displays the second line in [Message 1](#).

Message 1 DHCP Snooping with VLAN ACL Compatibility Error

```
% Error: Vlan member has access-list configured.
% Error: Vlan has an access-list configured.
```



Note: If DHCP snooping is enabled globally and any L2 port is configured, any IP ACL, MAC ACL, or DHCP Source-Address validation ACL won't block DHCP packets.

- FTOS provides 40K entries that can be divided between leased addresses and excluded addresses. By extension, the maximum number of pools you can configure depends on the on the subnet mask that you give to each pool. For example, if all pools were configured for a /24 mask, the total would be 40000/253 (approximately 158). If the subnet is increased, more pools can be configured. The maximum subnet that can be configured for a single pool is /17. FTOS displays an error message for configurations that exceed the allocated memory.
- E-Series supports 16K DHCP Snooping entries across 500 VLANs.
- C-Series, S-Series (S25/S50), S55, S60, S4810, and S4820T support 4K DHCP Snooping entries.
- All platforms support Dynamic ARP Inspection on 16 VLANs per system. Refer to [Dynamic ARP Inspection](#).



Note: If the DHCP server is located on the ToR and the VLTi (ICL) is down due to a failed link when a VLT node is rebooted in JumpStart mode, it will not be able to reach the DHCP server, resulting in BMP failure.

Configuration Tasks

- [Configure the System to be a DHCP Server](#)
- [Configure the System to be a Relay Agent](#)
- [Configure Secure DHCP](#)

Configure the System to be a DHCP Server

[Configure the System to be a DHCP Server](#) is supported only on platforms: C S **S4810** **S4820T**

A DHCP server is a network device that has been programmed to provide network configuration parameters to clients upon request. Servers typically serve many clients, making host management much more organized and efficient.

The key responsibilities of DHCP servers are:

1. **Address Storage and Management:** DHCP servers are the owners of the addresses used by DHCP clients. The server stores the addresses and manages their use, keeping track of which addresses have been allocated and which are still available.
2. **Configuration Parameter Storage and Management:** DHCP servers also store and maintain other parameters that are sent to clients when requested. These parameters specify in detail how a client is to operate.
3. **Lease Management:** DHCP servers use leases to allocate addresses to clients for a limited time. The DHCP server maintains information about each of the leases, including lease length.
4. **Responding To Client Requests:** DHCP servers respond to different types of requests from clients, primarily, granting, renewing, and terminating leases.
5. **Providing Administration Services:** The DHCP server includes functionality that allows an administrator to implement policies that govern how DHCP performs its other tasks.

Configuration Tasks

To configure DHCP, an administrator must first set up a DHCP server and provide it with configuration parameters and policy information including IP address ranges, lease length specifications, and configuration data that DHCP hosts need.

Configuring the Dell Force10 system to be a DHCP server is a 3-step process:

1. [Configure the Server for Automatic Address Allocation](#)
2. [Specify a Default Gateway](#)
3. [Enable DHCP Server](#)

Related Configuration Tasks

- [Configure a Method of Hostname Resolution](#)
- [Create Manual Binding Entries](#)
- [Debug DHCP server](#)
- [DHCP Clear Commands](#)

Configure the Server for Automatic Address Allocation

This feature is available on **C** and **S** (S25/S50) platforms only.

Automatic Address Allocation is an address assignment method by which the DHCP server leases an IP address to a client from a pool of available addresses.

Create an IP Address Pool

An address pool is a range of IP addresses that may be assigned by the DHCP server. Address pools are indexed by subnet number.

To create an address pool:

| Step | Task | Command Syntax | Command Mode |
|------|--|---|---------------|
| 1 | Access the DHCP server CLI context. | ip dhcp server | CONFIGURATION |
| 2 | Create an address pool and give it a name. | pool <i>name</i> | DHCP |
| 3 | Specify the range of IP addresses from which the DHCP server may assign addresses. <ul style="list-style-type: none"> <i>network</i> is the subnet address. <i>prefix-length</i> specifies the number of bits used for the network portion of the address you specify. | network <i>network</i> / <i>prefix-length</i> Prefix-length Range: 17 to 31 | DHCP <POOL> |
| 4 | Display the current pool configuration. | show config | DHCP <POOL> |

Once an IP address is leased to a client, only that client may release the address. FTOS performs a IP + MAC source address validation to ensure that no client can release another clients address. This is a default behavior and is separate from [IP+MAC Source Address Validation](#).

Exclude Addresses from the Address Pool

The DHCP server assumes that all IP addresses in a DHCP address pool are available for assigning to DHCP clients. You must specify the IP address that the DHCP server should not assign to clients.

| Task | Command Syntax | Command Mode |
|---|-------------------------|--------------|
| Exclude an address range from DHCP assignment. The exclusion applies to all configured pools. | excluded-address | DHCP |

Specify an Address Lease Time

| Task | Command Syntax | Command Mode |
|--|---|--------------|
| Specify an address lease time for the addresses in a pool. | lease { days [hours] [minutes] infinite } Default: 24 hours | DHCP <POOL> |

Specify a Default Gateway

The IP address of the default router should be on the same subnet as the client.

| Task | Command Syntax | Command Mode |
|---|--------------------------------------|--------------|
| Specify default gateway(s) for the clients on the subnet, in order of preference. | default-router <i>address</i> | DHCP <POOL> |

Enable DHCP Server

This feature is available on **C** and **S** (S25/S50) platforms only.

The DHCP server is disabled by default.

| Step | Task | Command Syntax | Command Mode |
|------|---|--|---------------|
| 1 | Enter the DHCP command-line context. | ip dhcp server | CONFIGURATION |
| 2 | Enable DHCP server. | no disable Default: Disabled | DHCP |
| 3 | Display the current DHCP configuration. | show config | DHCP |

In the illustration below, an IP phone is powered by PoE and has acquired an IP address from the Dell Force10 system, which is advertising LLDP-MED. The leased IP address is displayed using **show ip dhcp binding**, and confirmed with **show lldp neighbors**.

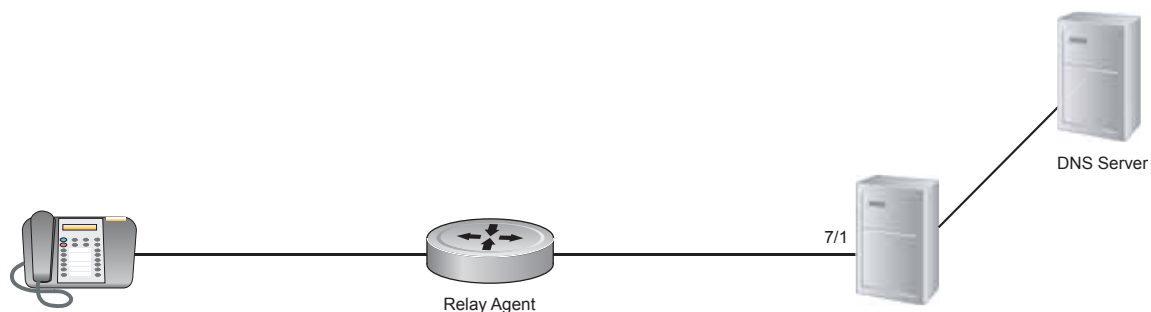

Configure a Method of Hostname Resolution

Dell Force10 systems are capable of providing DHCP clients with parameters for two methods of hostname resolution.

Address Resolution using DNS

A domain is a group of networks. DHCP clients query DNS IP servers when they need to correlate host names to IP addresses.

| Step | Task | Command Syntax | Command Mode |
|------|---|----------------------------------|--------------|
| 1 | Create a domain. | domain-name <i>name</i> | DHCP <POOL> |
| 2 | Specify in order of preference the DNS servers that are available to a DHCP client. | dns-server <i>address</i> | DHCP <POOL> |

Address Resolution using NetBIOS WINS

Windows Internet Naming Service (WINS) is a name resolution service that Microsoft DHCP clients use to correlate host names to IP addresses within a group of networks. Microsoft DHCP clients can be one of four types of NetBIOS nodes: broadcast, peer-to-peer, mixed, or hybrid.

| Step | Task | Command Syntax | Command Mode |
|------|--|---|--------------|
| 1 | Specify the NetBIOS Windows Internet Naming Service (WINS) name servers, in order of preference, that are available to Microsoft Dynamic Host Configuration Protocol (DHCP) clients. | netbios-name-server <i>address</i> | DHCP <POOL> |
| 2 | Specify the NetBIOS node type for a Microsoft DHCP client. Dell Force10 recommends specifying clients as hybrid. | netbios-node-type <i>type</i> | DHCP <POOL> |

Create Manual Binding Entries

An address binding is a mapping between the IP address and Media Access Control (MAC) address of a client. The DHCP server assigns the client an available IP address automatically, and then creates an entry in the binding table. However, the administrator can manually create an entry for a client; manual bindings are useful when you want to guarantee that a particular network device receives a particular IP address. Manual bindings can be considered single-host address pools. There is no limit on the number of manual bindings, but you can only configure one manual binding per host.



Note: FTOS does not prevent you from using a network IP as a host IP; be sure to not use a network IP as a host IP.

To create a manual binding:

| Step | Task | Command Syntax | Command Mode |
|------|--|--|--------------|
| 1 | Create an address pool | pool <i>name</i> | DHCP |
| 2 | Specify the client IP address. | host <i>address</i> | DHCP <POOL> |
| 3 | Specify the client hardware address. <ul style="list-style-type: none"> <i>hardware-address</i> is the client MAC address. <i>type</i> is the protocol of the hardware platform. The default protocol is Ethernet. | hardware-address <i>hardware-address type</i> | DHCP <POOL> |

Debug DHCP server

| Task | Command Syntax | Command Mode |
|--|--|----------------|
| Display debug information for DHCP server. | debug ip dhcp server [events packets] | EXEC Privilege |

DHCP Clear Commands

| Task | Command Syntax | Command Mode |
|---|--|----------------|
| Clear DHCP binding entries for the entire binding table. | clear ip dhcp binding | EXEC Privilege |
| Clear a DHCP binding entry for an individual IP address. | clear ip dhcp binding <i>ip address</i> | EXEC Privilege |
| Clear a DHCP address conflict. (This feature is available on C and S (S25/S50) platforms only.) | clear ip dhcp conflict | EXEC Privilege |
| Clear DHCP server counters. (This feature is available on C and S (S25/S50) platforms only.) | clear ip dhcp server statistics | EXEC Privilege |

Configure the System to be a Relay Agent

The following feature is available on platforms: **C** , **e** , **S** and **S4810** **S4820T**

DHCP clients and servers request and offer configuration information via broadcast DHCP messages. Routers do not forward broadcasts, so if there are no DHCP servers on the subnet, the client does not receive a response to its request and therefore cannot access the network.

You can configure an interface on the Dell Force10 system to relay the DHCP messages to a specific DHCP server using the command **ip helper-address** *dhcp-address* from INTERFACE mode, as shown in the illustration below. Specify multiple DHCP servers by entering the **ip helper-address** *dhcp-address* command multiple times.

When **ip helper-address** is configured, the system listens for DHCP broadcast messages on port 67. The system rewrites packets received from the client and forwards it via unicast; the system rewrites the destination IP address and writes its own address as the relay device. Responses from the server are unicast back to the relay agent on port 68 and the relay agent rewrites the destination address and forwards the packet to the client subnet via broadcast.



Note: DHCP Relay is not available on Layer 2 interfaces and VLANs.

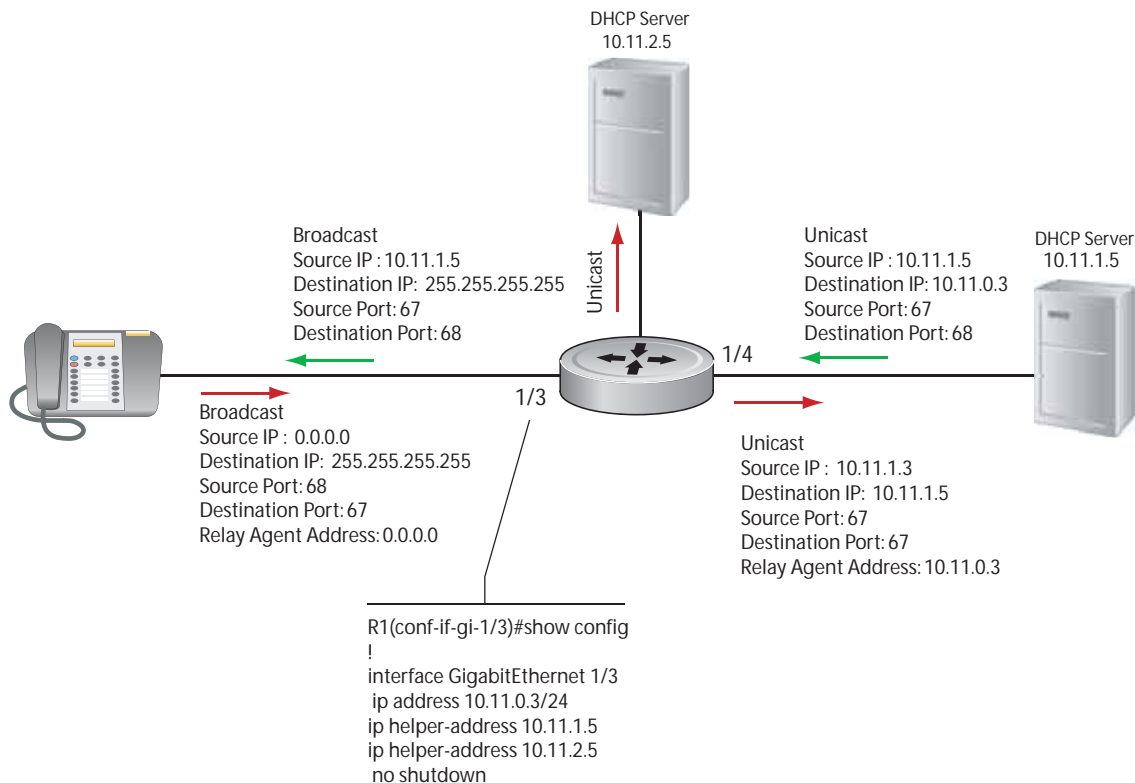

DHCP 001

To view the **ip helper-address** configuration for an interface, use the command **show ip interface** from EXEC privilege mode, as shown in the following example.

```
R1_E600#show ip int gig 1/3
GigabitEthernet 1/3 is up, line protocol is down
Internet address is 10.11.0.1/24
Broadcast address is 10.11.0.255
Address determined by user input
IP MTU is 1500 bytes
Helper address is 192.168.0.1
                  192.168.0.2
Directed broadcast forwarding is disabled
Proxy ARP is enabled
Split Horizon is enabled
Poison Reverse is disabled
ICMP redirects are not sent
ICMP unreachable are not sent
```

Configure the System for User Port Stacking

When you set the DHCP offer on the DHCP server, you can set the stacking-option variable to provide the stack-port detail so a stack can be formed when the units are connected.

Configure Secure DHCP

The following feature is available on platforms: C e S **S4810** **S4820T** Z except where noted.

DHCP as defined by RFC 2131 provides no authentication or security mechanisms. Secure DHCP is a suite of features that protects networks that use dynamic address allocation from spoofing and attacks.

- [Option 82](#)
- [DHCP Snooping](#)
- [Dynamic ARP Inspection](#)
- [Source Address Validation](#)

Option 82

RFC 3046 (Relay Agent Information option, or Option 82) is used for class-based IP address assignment.

The code for the Relay Agent Information option is 82, and is comprised of two sub-options, Circuit ID and Remote ID.

- **Circuit ID** is the interface on which the client-originated message is received.
- **Remote ID** identifies the host from which the message is received. The value of this sub-option is the MAC address of the relay agent that adds Option 82.

The DHCP relay agent inserts Option 82 before forwarding DHCP packets to the server. The server can use this information to:

- track the number of address requests per relay agent; restricting the number of addresses available per relay agent can harden a server against address exhaustion attacks.
- associate client MAC addresses with a relay agent to prevent offering an IP address to a client spoofing the same MAC address on a different relay agent.
- assign IP addresses according to the relay agent. This prevents generating DHCP offers in response to requests from an unauthorized relay agent.

The server echoes the option back to the relay agent in its response, and the relay agent can use the information in the option to forward a reply out the interface on which the request was received rather than flooding it on the entire VLAN.

The relay agent strips Option 82 from DHCP responses before forwarding them to the client.

| Task | Command Syntax | Command Mode |
|--|--|---------------|
| Insert Option 82 into DHCP packets. For routers between the relay agent and the DHCP server, enter the trust-downstream option. | ip dhcp relay information-option [trust-downstream] | CONFIGURATION |

DHCP Snooping

DHCP Snooping protects networks from spoofing. In the context of DHCP Snooping, all ports are either trusted or untrusted. By default, all ports are untrusted. Trusted ports are ports through which attackers cannot connect. Manually configure ports connected to legitimate servers and relay agents as trusted.

When DHCP Snooping is enabled, the relay agent builds a binding table—using DHCPACK messages—containing the client MAC address, IP addresses, IP address lease time, port, VLAN ID, and binding type. Every time the relay agent receives a DHCPACK on an trusted port, it adds an entry to the table.

The relay agent then checks all subsequent DHCP client-originated IP traffic (DHCPRELEASE, DHCPNACK, and DHCPDECLINE) against the binding table to ensure that the MAC-IP address pair is legitimate, and that the packet arrived on the correct port; packets that do not pass this check are forwarded to the server for validation. This check-point prevents an attacker from spoofing a client and declining or releasing the real client's address. Server-originated packets (DHCP OFFER, DHCPACK, DHCPNACK) that arrive on an untrusted port are also dropped. This check-point prevents an attacker from impersonating as a DHCP server to facilitate a man-in-the-middle attack.

Binding table entries are deleted when a lease expires, or the relay agent encounters a DHCPRELEASE, DHCPNACK, DHCPDECLINE.

FTOS Behavior: Introduced in FTOS version 7.8.1.0, DHCP Snooping was available for Layer 3 only and dependent on DHCP Relay Agent (**ip helper-address**). FTOS version 8.2.1.0 extends DHCP Snooping to Layer 2, and you do not have to enable relay agent to snoop on Layer 2 interfaces.

FTOS Behavior: Binding table entries are deleted when a lease expires or when the relay agent encounters a DHCPRELEASE. Starting with FTOS Release 8.2.1.2, line cards maintain a list of snooped VLANs. When the binding table is exhausted, DHCP packets are dropped on snooped VLANs, while these packets are forwarded across non-snooped VLANs. Since DHCP packets are dropped, no new IP address assignments are made. However, DHCPRELEASE and DHCPDECLINE packets are allowed so that the DHCP snooping table can decrease in size. Once the table usage falls below the maximum limit of 4000 entries, new IP address assignments are allowed.



Note: DHCP server packets will be dropped on all untrusted interfaces of a system configured for DHCP snooping. To prevent these packets from being dropped, configure **ip dhcp snooping trust** on the server-connected port.

Enable DHCP snooping

| Step | Task | Command Syntax | Command Mode |
|------|---|-------------------------------|---------------|
| 1 | Enable DHCP Snooping globally. | ip dhcp snooping | CONFIGURATION |
| 2 | Specify ports connected to DHCP servers as trusted. | ip dhcp snooping trust | INTERFACE |
| 3 | Enable DHCP Snooping on a VLAN. | ip dhcp snooping vlan | CONFIGURATION |

Add a static entry in the binding table

| Task | Command Syntax | Command Mode |
|--|-------------------------------------|----------------|
| Add a static entry in the binding table. | ip dhcp snooping binding mac | EXEC Privilege |

Clear the binding table

| Task | Command Syntax | Command Mode |
|--|---------------------------------------|----------------|
| Delete all of the entries in the binding table | clear ip dhcp snooping binding | EXEC Privilege |

Display the contents of the binding table

| Task | Command Syntax | Command Mode |
|--|------------------------------|----------------|
| Display the contents of the binding table. | show ip dhcp snooping | EXEC Privilege |

View the DHCP Snooping statistics with the **show ip dhcp snooping** command.

```

FTOS#show ip dhcp snooping

IP DHCP Snooping                : Enabled.
IP DHCP Snooping Mac Verification : Disabled.
IP DHCP Relay Information-option  : Disabled.
IP DHCP Relay Trust Downstream   : Disabled.

Database write-delay (In minutes) : 0

DHCP packets information
Relay Information-option packets  : 0
Relay Trust downstream packets   : 0
Snooping packets                 : 0

Packets received on snooping disabled L3 Ports : 0
Snooping packets processed on L2 vlans        : 142

DHCP Binding File Details
Invalid File                               : 0
Invalid Binding Entry                     : 0
Binding Entry lease expired                : 0
List of Trust Ports                        :Te 0/49
List of DHCP Snooping Enabled Vlans       :Vl 10
List of DAI Trust ports                    :Te 0/49

```

Drop DHCP packets on snooped VLANs only

Binding table entries are deleted when a lease expires or the relay agent encounters a DHCPRELEASE.

Starting with FTOS Release 8.2.1.1, line cards maintain a list of snooped VLANs. When the binding table fills, DHCP packets are dropped only on snooped VLANs, while such packets will be forwarded across non-snooped VLANs. Since DHCP packets are dropped, no new IP address assignments are made. However, DHCP Release and Decline packets are allowed so that the DHCP snooping table can decrease in size. Once the table usage falls below the max limit of 4000 entries, new IP address assignments are allowed.

View the number of entries in the table with the **show ip dhcp snooping binding** command. This output displays the snooping binding table created using the ACK packets from the trusted port.

```
FTOS#show ip dhcp snooping binding
```

```
Codes : S - Static D - Dynamic
```

| IP Address | MAC Address | Expires(Sec) | Type | VLAN | Interface |
|------------|-------------------|--------------|------|-------|-----------|
| 10.1.1.251 | 00:00:4d:57:f2:50 | 172800 | D | Vl 10 | Gi 0/2 |
| 10.1.1.252 | 00:00:4d:57:e6:f6 | 172800 | D | Vl 10 | Gi 0/1 |
| 10.1.1.253 | 00:00:4d:57:f8:e8 | 172740 | D | Vl 10 | Gi 0/3 |
| 10.1.1.254 | 00:00:4d:69:e8:f2 | 172740 | D | Vl 10 | Te 0/50 |

```
Total number of Entries in the table : 4
```

Dynamic ARP Inspection

Dynamic ARP inspection prevents ARP spoofing by forwarding only ARP frames that have been validated against the DHCP binding table.

ARP is a stateless protocol that provides no authentication mechanism. Network devices accept ARP requests and replies from any device, and ARP replies are accepted even when no request was sent. If a client receives an ARP message for which a relevant entry already exists in its ARP cache, it overwrites the existing entry with the new information.

The lack of authentication in ARP makes it vulnerable to spoofing. ARP spoofing is a technique attackers use to inject false IP-to-MAC mappings into the ARP cache of a network device. It is used to launch man-in-the-middle (MITM), and denial-of-service (DoS) attacks, among others.

A spoofed ARP message is one in which the MAC address in the sender hardware address field and the IP address in the sender protocol field are strategically chosen by the attacker. For example, in an MITM attack, the attacker sends a client an ARP message containing the attacker's MAC address and the gateway's IP address. The client then thinks that the attacker is the gateway, and sends all internet-bound packets to it. Likewise, the attacker sends the gateway an ARP message containing the attacker's MAC address and the client's IP address. The gateway then thinks that the attacker is the client and forwards all packets addressed to the client to it. As a result, the attacker is able to sniff all packets to and from the client.

Other attacks using ARP spoofing include:

- broadcast—an attacker can broadcast an ARP reply that specifies FF:FF:FF:FF:FF:FF as the gateway's MAC address, resulting in all clients broadcasting all internet-bound packets.
- MAC flooding—an attacker can send fraudulent ARP messages to the gateway until the ARP cache is exhausted, after which, traffic from the gateway is broadcast.

- denial of service—an attacker can send a fraudulent ARP messages to a client to associate a false MAC address with the gateway address, which would blackhole all internet-bound packets from the client.



Note: DAI uses entries in the L2SysFlow CAM region, a sub-region of SystemFlow. One CAM entry is required for every DAI-enabled VLAN. You can enable DAI on up to 16 VLANs on a system. However, the ExaScale default CAM profile allocates only 9 entries to the L2SysFlow region for DAI. You can configure 10 to 16 DAI-enabled VLANs by allocating more CAM space to the L2SysFlow region before enabling DAI.

SystemFlow has 102 entries by default. This region is comprised of two sub-regions: L2Protocol and L2SystemFlow. L2Protocol has 87 entries, and L2SystemFlow has 15 entries. Six L2SystemFlow entries are used by Layer 2 protocols, leaving 9 for DAI. L2Protocol can have a maximum of 100 entries, and this region must be expanded to capacity before you can increase the size of L2SystemFlow. This is relevant when you are enabling DAI on VLANs. If, for example, you want to enable DAI on 16 VLANs, you need 7 more entries; in this case, reconfigure the SystemFlow region for 122 entries:

layer-2 eg-acl value fib value frpp value ing-acl value learn value l2pt value qos value system-flow 122

The logic is as follows:

L2Protocol has 87 entries by default and must be expanded to its maximum capacity, 100 entries, before L2SystemFlow can be increased; therefore 13 more L2Protocol entries are required. L2SystemFlow has 15 entries by default, but only 9 are for DAI; to enable DAI on 16 VLANs, 7 more entries are required. 87 L2Protocol + 13 additional L2Protocol + 15 L2SystemFlow + 7 additional L2SystemFlow equals 122.

| Step | Task | Command Syntax | Command Mode |
|------|--|-----------------------|----------------|
| 1 | Enable DHCP Snooping. | | |
| 2 | Validate ARP frames against the DHCP Snooping binding table. | arp inspection | INTERFACE VLAN |

View the number of entries in the ARP database with the **show arp inspection database** command.

```
FTOS#show arp inspection database
```

```

Protocol      Address          Age(min)  Hardware Address  Interface  VLAN  CPU
-----
Internet     10.1.1.251      -         00:00:4d:57:f2:50  Gi 0/2    V1 10  CP
Internet     10.1.1.252      -         00:00:4d:57:e6:f6  Gi 0/1    V1 10  CP
Internet     10.1.1.253      -         00:00:4d:57:f8:e8  Gi 0/3    V1 10  CP
Internet     10.1.1.254      -         00:00:4d:69:e8:f2  Te 0/50   V1 10  CP
FTOS#

```

Use **show arp inspection statistics** command to see how many valid and invalid ARP packets have been processed.

```
FTOS#show arp inspection statistics

Dynamic ARP Inspection (DAI) Statistics
-----
Valid ARP Requests           : 0
Valid ARP Replies           : 1000
Invalid ARP Requests        : 1000
Invalid ARP Replies         : 0
FTOS#
```

Bypass the ARP Inspection

You can configure a port to skip ARP inspection by defining the interface as trusted, which is useful in multi-switch environments. ARPs received on trusted ports bypass validation against the binding table. All ports are untrusted by default.

| Task | Command Syntax | Command Mode |
|---|-----------------------------|--------------|
| Specify an interface as trusted so that ARPs are not validated against the binding table. | arp inspection-trust | INTERFACE |

FTOS Behavior: Introduced in FTOS version 8.2.1.0, Dynamic ARP Inspection (DAI) was available for Layer 3 only. FTOS version 8.2.1.1 extends DAI to Layer 2.

Source Address Validation

Using the DHCP binding table, FTOS can perform three types of source address validation (SAV):

- **IP Source Address Validation** prevents IP spoofing by forwarding only IP packets that have been validated against the DHCP binding table.
- **DHCP MAC Source Address Validation** verifies a DHCP packet's source hardware address matches the client hardware address field (CHADDR) in the payload.
- **IP+MAC Source Address Validation** verifies that the IP source address and MAC source address are a legitimate pair.

IP Source Address Validation

IP Source Address Validation (SAV) prevents IP spoofing by forwarding only IP packets that have been validated against the DHCP binding table. A spoofed IP packet is one in which the IP source address is strategically chosen to disguise the attacker. For example, using ARP spoofing an attacker can assume a legitimate client's identity and receive traffic addressed to it. Then the attacker can spoof the client's IP address to interact with other clients.

The DHCP binding table associates addresses assigned by the DHCP servers, with the port on which the requesting client is attached. When IP Source Address Validation is enabled on a port, the system verifies that the source IP address is one that is associated with the incoming port. If an attacker is impersonating as a legitimate client the source address appears on the wrong ingress port, and the system drops the packet. Likewise, if the IP address is fake, the address will not be on the list of permissible addresses for the port, and the packet is dropped.

| Task | Command Syntax | Command Mode |
|-------------------------------------|--|--------------|
| Enable IP Source Address Validation | ip dhcp source-address-validation | INTERFACE |

 **Note:** If IP Source Guard is enabled using the **ip dhcp source-address-validation** command and there are 187 entries or more in the current DHCP snooping binding table, Source Address Validation (SAV) may not be applied to all entries. To ensure that SAV is applied correctly to all entries, enable the **ip dhcp source-address-validation** command before adding entries to the binding table.

DHCP MAC Source Address Validation

DHCP MAC Source Address Validation (SAV) validates a DHCP packet's source hardware address against the client hardware address field (CHADDR) in the payload.

FTOS Release 8.2.1.1 ensures that the packet's source MAC address is checked against the CHADDR field in the DHCP header only for packets from snooped VLANs.

| Task | Command Syntax | Command Mode |
|--|--|---------------|
| Enable DHCP MAC Source Address Validation. | ip dhcp snooping verify mac-address | CONFIGURATION |

IP+MAC Source Address Validation

The following feature is available on platforms: **C S** **S4810** **S4820T**

IP Source Address Validation validates the IP source address of an incoming packet against the DHCP Snooping binding table. IP+MAC Source Address Validation ensures that the IP source address and MAC source address are a legitimate pair, rather validating each attribute individually. IP+MAC Source Address Validation cannot be configured with IP Source Address Validation.

| Step | Task | Command Syntax | Command Mode |
|------|--|---|----------------|
| 1 | Allocate at least one FP block to the ipmacacl CAM region. | cam-acl l2acl | CONFIGURATION |
| 2 | Save the running-config to the startup-config. | copy running-config startup-config | EXEC Privilege |
| 3 | Reload the system. | reload | EXEC Privilege |

| Step | Task | Command Syntax | Command Mode |
|-------------|--|--|---------------------|
| 4 | Enable IP+MAC Source Address Validation. | ip dhcp source-address-validation ipmac | INTERFACE |

FTOS creates an ACL entry for each IP+MAC address pair in the binding table and applies it to the interface.

| Task | Command Syntax | Command Mode |
|--|--|---------------------|
| Display the IP+MAC ACL for an interface for the entire system. | show ip dhcp snooping source-address-validation [interface] | EXEC Privilege |

Equal Cost Multi-Path (ECMP)

Equal Cost Multi-Path (ECMP) is supported on platforms: E C S **S4810** **S4820T**

ECMP for Flow-based Affinity

ECMP for Flow-based Affinity is available on platforms: E **S4810** **S4820T**

The hashing algorithm on E-Series TeraScale and E-Series ExaScale are different. Hashing on ExaScale is based on CRC, checksum, or XOR, and the algorithm on TeraScale is based on checksum only. If flow-based affinity is to be maintained by an ExaScale and TeraScale chassis, they must both use the same hashing algorithm and seed value, and ECMP must deterministically choose a next hop.

 **Note:** IPv6 /128 routes having multiple paths do not form ECMPs. The /128 route is treated as a host entry and finds its place in the host table.

 **Note:** Using XOR algorithms will result in imbalanced loads across an ECMP/LAG when the number of members in said ECMP/LAG is a multiple of 4.

- [Configurable Hash Algorithm](#)
- [Configurable Hash Algorithm Seed](#)
- [Deterministic ECMP Next Hop](#)
- [Link Bundle Monitoring](#)

Configurable Hash Algorithm

TeraScale has one algorithm that is used for LAGs, ECMP, and NH-ECMP, and ExaScale can use three different algorithms for each of these features. To adjust the ExaScale behavior to match TeraScale, use the following command:

| Task | Command Syntax | Command Mode |
|---|---|---------------|
| Change the ExaScale hash-algorithm for LAG, ECMP, and NH-ECMP to match TeraScale. | hash-algorithm ecmp checksum 0 lag checksum 0 nh-ecmp checksum 0 | CONFIGURATION |

FTOS Behavior: In FTOS versions prior to 8.2.1.2, the ExaScale default hash-algorithm is 0. Beginning with version 8.2.1.2, the default hash-algorithm is 24.

Deterministic ECMP Next Hop

Deterministic ECMP Next Hop arranges all ECMPs in order before writing them into the CAM. For example, suppose the RTM learns 8 ECMPs in the order that the protocols and interfaces came up. In this case, the FIB and CAM sort them so that the ECMPs are always arranged. This implementation ensures that every chassis having the same prefixes orders the ECMPs the same.

With 8 or less ECMPs, the ordering is lexicographic and deterministic. With more than 8 ECMPs, ordering is deterministic, but it is not in lexicographic order.

| Task | Command Syntax | Command Mode |
|--|--------------------------------|---------------|
| Enable IPv4 Deterministic ECMP Next Hop. | ip ecmp-deterministic | CONFIGURATION |
| Enable IPv6 Deterministic ECMP Next Hop. | ipv6 ecmp-deterministic | CONFIGURATION |

Note: Packet loss might occur when you enable **ip/ipv6 ecmp-deterministic** for the first-time only.

Configurable Hash Algorithm Seed

Deterministic ECMP sorts ECMPs in order even though RTM provides them in a random order. However, the hash algorithm uses as a seed the lower 12 bits of the chassis MAC, which yields a different hash result for every chassis. This means that for a given flow, even though the prefixes are sorted, two unrelated chassis will select different hops.

FTOS provides a CLI-based solution for modifying the hash seed to ensure that on each configured system, the ECMP selection is same. When configured, the same seed is set for ECMP, LAG, and NH, and is used for incoming traffic only.



Note: While the seed is stored separately on each port-pipe, the same seed is used across all CAMs.

Note: You cannot separate LAG and ECMP, but you can use different algorithms across chassis with the same seed. If LAG member ports span multiple port-pipes and line cards, set the seed to the same value on each port-pipe to achieve deterministic behavior.

Note: If the hash algorithm configuration is removed. Hash seed will not go to original factory default setting.

| Task | Command Syntax | Command Mode |
|----------------------------------|---|---------------|
| Specify the hash algorithm seed. | hash-algorithm seed <i>value</i> [linecard <i>number</i>] [port-set <i>number</i>] Range: 0 to 4095. | CONFIGURATION |

In the illustration below, Core Router 1 is an E-Series TeraScale and Core Router 2 is an E-Series ExaScale. They have similar configurations and have routes for prefix P with two possible next-hops. When Deterministic ECMP is enabled and the hash algorithm and seed are configured the same, each flow is consistently sent to the same next hop even though they are routed through two different chassis.

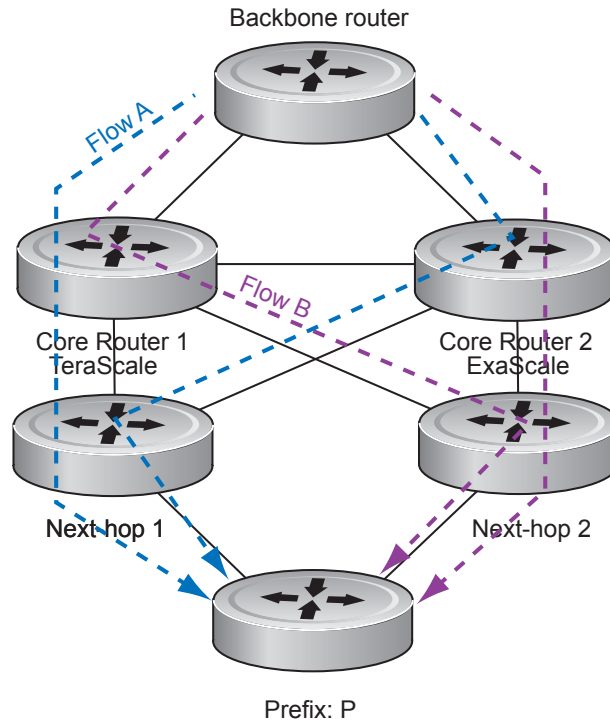

Link Bundle Monitoring

Link Bundle Monitoring is supported only on platforms: **S4810** **S4820T**

Monitoring linked ECMP bundles allows traffic distribution amounts in a link to be monitored for unfair distribution at any given time. A default threshold of 60% is defined as an acceptable amount of traffic on a member link. Links are monitored in 15-second intervals for three consecutive instances. Any deviation within that time causes a syslog to be sent and an alarm event to be generated. When the deviation clears, another syslog is sent and a clear alarm event is generated.

Message 1 Link bundle monitoring percent threshold

```
%STKUNIT0-M:CP %IFMGR-5-BUNDLE_UNEVEN_DISTRIBUTION: Found uneven distribution in LAG bundle 11.
```

The link bundle utilization is calculated as the total bandwidth of all links divided by the total bytes-per-second of all links. Within each ECMP group, interfaces can be specified. If monitoring is enabled for the ECMP group, the utilization calculation is performed when the utilization of the link-bundle (not a link within a bundle) exceeds 60%.

Enable link bundle monitoring using the **ecmp-group** command.



Note: An ecmp-group index is generated automatically for each unique ecmp-group when the user configures multipath routes to the same network. The system can generate a maximum of 512 unique ecmp-groups. The ecmp-group indexes are generated in even numbers (0, 2, 4, 6... 1022) and are for information only.

For link bundle monitoring with ECMP, the **ecmp-group** command is used to enable the link bundle monitoring feature. The ecmp-group with *id 2*, enabled for link bundle monitoring is *user configured*. This is different from the ecmp-group *index 2* that is created by configuring routes and is *automatically generated*.

These two ecmp-groups are not related in any way.

Managing ECMP Group Paths

Managing ECMP Group Paths is supported only on platforms: **S4810** **S4820T**

Configure the maximum number of paths for an ECMP route that the L3 CAM can hold to avoid path degeneration. When the maximum number of routes is not configured, the CAM can hold a maximum ECMP per route.

Use the **ip ecmp-group path-fallback** command to enable or disable the feature.

| Task | Command Syntax | Command Mode |
|--|--|---------------|
| Configure the maximum number of paths per ECMP group | ip ecmp-group maximum-paths {2-64} | CONFIGURATION |
| Enable ECMP group path management | ip ecmp-group path-fallback | CONFIGURATION |

Note: You must save the new ECMP settings to the startup-config (**write-mem**) then reload the system for the new settings to take effect.

```
pt-s4801-templ(conf)#ip ecmp-group maximum-paths 3
User configuration has been changed. Save the configuration and reload to take effect
pt-s4801-templ(conf)#
```

Enabling FIPS Cryptography

FIPS Cryptography is supported on the **S4810** and the **S4820T**

This chapter describes how to enable FIPS cryptography requirements on the Dell Force10 S4810 platform. This feature provides cryptographic algorithms conforming to various FIPS standards published by the National Institute of Standards and Technology (NIST), a non-regulatory agency of the US Department of Commerce. The FIPS mode is also validated for numerous platforms to meet the FIPS-140-2 standard for a software-based cryptographic module.

 **Note:** The FIPS mode included in this release is the OpenSSL FIPS Object Module v2.0, which has been validated to meet FIPS-140-2 requirements, per certificate #1747. The S4810 or S4820T platform is not one of the validated platforms. Dell Force10 has contracted with the OpenSSL Foundation to complete a Change Letter validation of the platform for this FIPS mode. A patch release will be available once that Change Letter validation has been completed.

 **Note:** For release 8.3.12.0 and 8.3.19.0 only the SSH and SCP copy features use the FIPS cryptographic mode to secure management interface user sessions and file transfers. Other features that use cryptographic algorithms do not, or cannot, use the FIPS mode. The administrator must configure the management interfaces to limit access to/from the system to SSH alone.

This chapter describes the FIPS configuration procedure:

- [Preparing the System](#)
- [Enabling FIPS Mode](#)
- [Generating Host-Keys](#)
- [Monitoring FIPS Mode Status](#)
- [Disabling the FIPS Mode](#)

Preparing the System

Before you enable FIPS mode on the S4810 or S4820T, Dell Force10 recommends making the following steps to your system:

- disable the Telnet server (only SSH (Secure Shell) should be used to access the system).
- disable the FTP server (only SCP (Secure Copy) should be used to transfer files to and from the system).
- Attach a secure, standalone host to the console port to be used for FIPS configuration.

Enabling FIPS Mode

You must use the console port to enable or disable FIPS mode. The host attached to the console port must be secured against unauthorized access. Any attempts to enable or disable FIPS mode from a virtual terminal session are denied.

To enable FIPS mode:

| Task | Command Syntax | Command Mode |
|---------------------------------------|------------------|--------------|
| Enable FIPS mode from a console port. | fips mode enable | CONFIG |

When the FIPS mode is enabled, the following actions are taken:

- If enabled, the SSH server will be disabled.
- All open SSH and Telnet sessions, as well as all SCP and FTP file transfers, will be closed.
- Any existing host keys (both RSA and RSA1) will be deleted from system memory and NVRAM storage.
- The FIPS mode is enabled.
 - If the SSH server was enabled when the **fips mode enable** command was entered, it will be re-enabled for version 2 *only*.
 - If the SSH server is re-enabled, a new RSA host key-pair will be generated automatically. This key-pair can also be created manually using the **crypto key generate** command.

Note: Under certain unusual circumstances, it is possible for the FIPS enable command to indicate a failure.

- This will occur if any of the self-tests fail when FIPS mode is enabled
- This will occur if there were existing SSH/Telnet sessions that could not be closed successfully in a reasonable amount of time. In general this can occur if a user at a remote host is in the process of establishing an SSH session to the local system, and has been prompted to accept a new host key or to enter a password, but is not responding to the request. Assuming this is a transient condition, attempting to enable FIPS mode again should be successful.

Generating Host-Keys

When FIPS mode is enabled, or disabled, the system will delete the current public/private host-key pair, terminate any SSH sessions that are in progress (deleting all the per-session encryption key information), actually enable/test the FIPS mode, generate new host-keys, and re-enable the SSH server (assuming it was enabled before enabling FIPS). Refer to **SSH Server and SCP Commands** in the **Security** chapter of the *FTOS Command Line Interface Guide* for more information.

Monitoring FIPS Mode Status

The status of the current FIPS mode (Enabled/Disabled) can be viewed directly using either the **show fips status** command or the **show system** command as shown below.

```
FTOS#show fips status
FIPS Mode      : Enabled
for the system using the show system command.
```

```
FTOS#show system

Stack MAC : 00:01:e8:8a:ff:0c

Reload Type : normal-reload [Next boot : normal-reload]

-- Unit 0 --
Unit Type   : Management Unit
Status      : online
Next Boot   : online
Required Type : S4810 - 52-port GE/TE/FG (SE)
Current Type : S4810 - 52-port GE/TE/FG (SE)
Master priority : 0
Hardware Rev : 3.0
Num Ports   : 64
Up Time     : 7 hr, 3 min
FTOS Version : 4810-8-3-7-1061
Jumbo Capable : yes
POE Capable : no
FIPS Mode    : enabled
Burned In MAC : 00:01:e8:8a:ff:0c
No Of MACs   : 3
...
```

Disabling the FIPS Mode

Use the console port to disable FIPS mode.

To disable the FIPS mode:

| Task | Command Syntax | Command Mode |
|---|---------------------|--------------|
| To disable FIPS mode from a console port. | no fips mode enable | CONFIG |

The following Warning message displays:

```
WARNING: Disabling FIPS mode will close all SSH/Telnet connections, restart those servers, and destroy
all configured host keys.
Proceed (y/n) ?
```

When the FIPS mode is disabled, the following changes occur:

- The SSH server is disabled.
- All open SSH and Telnet sessions, as well as all SCP and FTP file transfers, are closed.
- Any existing host keys (both RSA and RSA1) are deleted from system memory and NVRAM storage.
- The FIPS mode is disabled.
- The SSH server is re-enabled.
- The telnet server is re-enabled if it is present in the configuration
- New 1024-bit RSA and RSA1 host key-pairs are created.

FIP Snooping

FIP snooping is supported on platforms: **S4810** **S4820T**

This chapter describes the FIP snooping concepts and configuration procedures:

- [Fibre Channel over Ethernet](#)
- [Ensuring Robustness in a Converged Ethernet Network](#)
- [FIP Snooping on Ethernet Bridges](#)
- [FIP Snooping in a Switch Stack](#)
- [Configuring FIP Snooping](#)
- [Displaying FIP Snooping Information](#)
- [FIP Snooping Configuration Example](#)

Fibre Channel over Ethernet

Fibre Channel over Ethernet (FCoE) provides a converged Ethernet network that allows the combination of storage-area network (SAN) and LAN traffic on a Layer 2 link by encapsulating Fibre Channel data into Ethernet frames.

FCoE works with the Ethernet enhancements provided in data center bridging (DCB) to support lossless (no-drop) SAN and LAN traffic. In addition, DCB provides flexible bandwidth sharing for different traffic types, such as LAN and SAN, according to 802.1p priority classes of service. For more information, refer to the [Data Center Bridging \(DCB\)](#) chapter.

Ensuring Robustness in a Converged Ethernet Network

Fibre Channel networks used for SAN traffic employ switches that operate as trusted devices. End devices log into the switch to which they are attached in order to communicate with other end devices attached to the Fibre Channel network. Because Fibre Channel links are point-to-point, a Fibre Channel switch controls all storage traffic that an end device sends and receives over the network. As a result, the switch can enforce zoning configurations, ensure that end devices use their assigned addresses, and secure the network from unauthorized access and denial-of-service attacks.

To ensure similar Fibre Channel robustness and security with FCoE in an Ethernet cloud network, the Fibre Channel over Ethernet initialization protocol (FIP) establishes virtual point-to-point links between FCoE end-devices (server ENodes and target storage devices) and FCoE forwarders (FCFs) over transit FCoE-enabled bridges.

Ethernet bridges commonly provide access control list (ACLs) that can emulate a point-to-point link by providing the traffic enforcement required to create a Fibre Channel-level of robustness. In addition, FIP serves as a Layer 2 protocol to:

- Operate between FCoE end-devices and FCFs over intermediate Ethernet bridges to prevent unauthorized access to the network and achieve the required security.
- Allow transit Ethernet bridges to efficiently monitor FIP frames passing between FCoE end-devices and an FCF, and use the FIP snooping data to dynamically configure ACLs on the bridge to only permit traffic authorized by the FCF.

FIP enables FCoE devices to discover one another, initialize and maintain virtual links over an Ethernet network, and access storage devices in a storage area network. FIP satisfies the Fibre Channel requirement for point-to-point connections by creating a unique virtual link for each connection between an FCoE end-device and an FCF via a transit switch.

FIP provides functionality for discovering and logging in to an FCF. After discovering and logging in, FIP allows FCoE traffic to be sent and received between FCoE end-devices (ENodes) and the FCF. FIP uses its own EtherType and frame format. The following figure shows the communication that occurs between an ENode server and an FCoE switch (FCF).

FIP performs the following functions:

- FIP virtual local area network (VLAN) discovery: FCoE devices (ENodes) discover the FCoE VLANs on which to transmit and receive FIP and FCoE traffic.
- FIP discovery: FCoE end-devices and FCFs are automatically discovered.
- Initialization: FCoE devices perform fabric login (FLOGI) and fabric discovery (FDISC) to create a virtual link with an FCoE switch.
- Maintenance: A valid virtual link between an FCoE device and an FCoE switch is maintained and the link termination logout (LOGO) functions properly.

Figure 17-1. FIP discovery and login between an ENode and an FCF

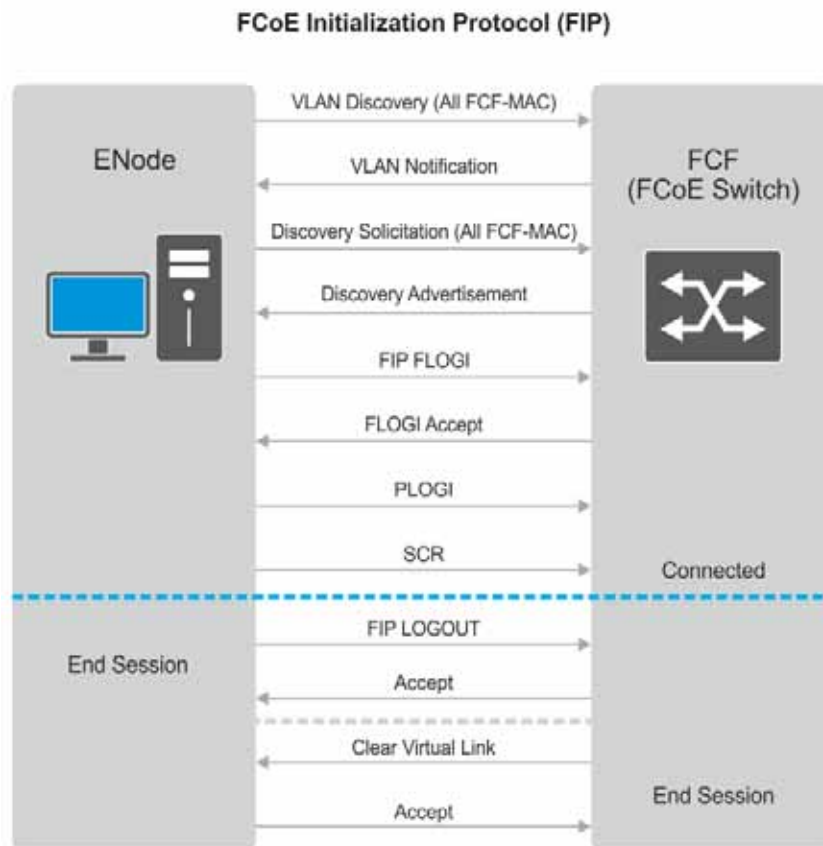

FIP Snooping on Ethernet Bridges

In a converged Ethernet network, intermediate Ethernet bridges can snoop on FIP packets during the login process on an FCF. Then, using ACLs, a transit bridge can permit only authorized FCoE traffic to be transmitted between an FCoE end-device and an FCF. An Ethernet bridge that provides these functions is called a FIP snooping bridge (FSB).

On a FIP snooping bridge, ACLs are created dynamically as FIP login frames are processed. The ACLs are installed on switch ports configured for any of the following port modes:

- ENode mode for server-facing ports
- FCF mode for a trusted port directly connected to an FCF

You must enable FIP snooping on the switch, configure the FIP snooping parameters, and configure CAM allocation for FCoE. When you enable FIP snooping, all ports on the switch by default become ENode ports.

Dynamic ACL generation on the switch operating as a FIP snooping bridge functions as follows:

- Port-based ACLs are applied on all three port modes: on ports directly connected to an FCF, server-facing ENode ports, and bridge-to-bridge links.
- Port-based ACLs take precedence over global ACLs.
- FCoE-generated ACLs take precedence over user-configured ACLs. A user-configured ACL entry cannot deny FCoE and FIP snooping frames.

Figure 17-2 shows a switch used as a FIP snooping bridge in a converged Ethernet network. The ToR switch operates as an FCF for FCoE traffic. Converged LAN and SAN traffic is transmitted between the ToR switch and an S4810 (or S4820T) switch. The switch operates as a lossless FIP snooping bridge to transparently forward FCoE frames between the ENode servers and the FCF switch.

Figure 17-2. FIP Snooping on an S4810 or S4820T Switch

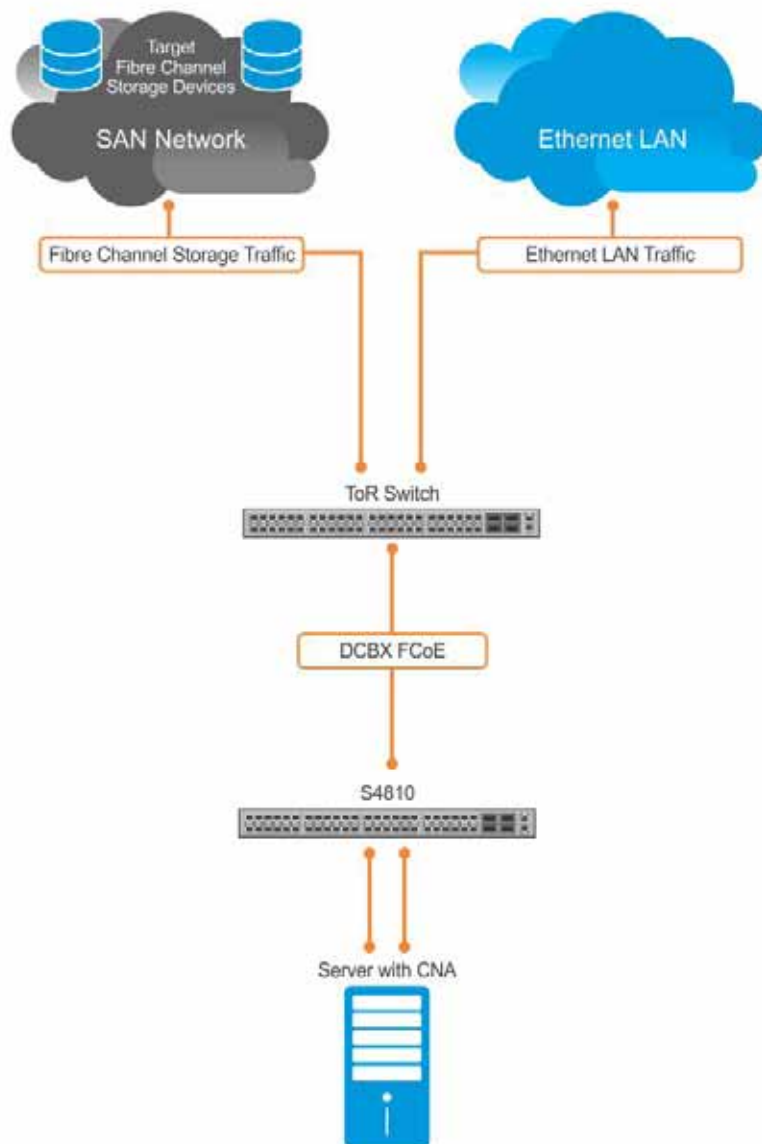

The following sections describe how to configure the FIP snooping feature on a switch that functions as a FIP snooping bridge so that it can perform the following functions:

- Allocate CAM resources for FCoE.
- Perform FIP snooping (allowing and parsing FIP frames) globally on all VLANs or on a per-VLAN basis.
- Set the FCoE MAC address prefix (FC-MAP) value used by an FCF to assign a MAC address to an FCoE end-device (server ENode or storage device) after a server successfully logs in. The FC-MAP value is used in the ACLs installed in bridge-to-bridge links on the switch.
- Set the FCF or Bridge-to-Bridge Port modes to provide additional port security on ports that are directly connected to an FCF and have links to other FIP snooping bridges.
- Check FIP snooping-enabled VLANs to ensure that they are operationally active.
- Process FIP VLAN discovery requests and responses, advertisements, solicitations, FLOGI/FDISC requests and responses, FLOGO requests and responses, keep-alive packets, and clear virtual-link messages.

FIP Snooping in a Switch Stack

FIP snooping supports switch stacking as follows:

- A switch stack configuration is synchronized with the standby stack unit.
- Dynamic population of the FCoE database (ENode, Session, and FCF tables) is synchronized with the standby stack unit. The FCoE database is maintained by snooping FIP keep-alive messages.
- In case of a failover, the new master switch starts the required timers for the FCoE database tables. Timers run only on the master stack unit.

Configuring FIP Snooping

The configuration of FIP snooping consists of the following tasks:

1. Enable the FIP snooping feature on a switch to maintain FIP snooping information on the switch.
2. Enable FIP snooping on all VLANs (globally) or individual VLANs on a FIP snooping bridge.
3. Configure the FC-Map value applied globally by the switch on all VLANs or an individual VLAN.
4. Configure FCoE-Trusted mode for a FIP snooping bridge-to-bridge link.
5. Configure FCF mode for a FIP snooping bridge-to-FCF link.

For a sample FIP snooping configuration, refer to [Figure 17-11](#).

Enabling the FIP Snooping Feature



Note: FIP Snooping is disabled by default. To enable this feature, you must follow the [Configuration Procedure](#).

As soon as you enable the FIP snooping feature on a switch-bridge, existing VLAN-specific and FIP snooping configurations are applied. The FCoE database is populated when the switch connects to a converged network adapter (CNA) or FCF port and compatible DCB configurations are synchronized. By default, all FCoE and FIP frames are dropped unless specifically permitted by existing FIP snooping-generated ACLs. You can reconfigure any of the FIP snooping settings.

If you disable FIP snooping, FIP and FCoE traffic are handled as normal Ethernet frames and no FIP snooping ACLs are generated. The VLAN-specific and FIP snooping configuration is disabled and stored until you re-enable FIP snooping and the configurations are re-applied.

Enabling FIP Snooping on VLANs

You can enable FIP snooping globally on a switch on all VLANs or on a specified VLAN. When you enable FIP snooping on VLANs:

- FIP frames are allowed to pass through the switch on the enabled VLANs and are processed to generate FIP snooping ACLs.
- FCoE traffic is allowed on VLANs only after a successful virtual-link initialization (fabric login FLOGI) between an ENode and an FCF. All other FCoE traffic is dropped.
- You must configure at least one interface for FCF (FIP snooping bridge-bridge) mode on a FIP snooping-enabled VLAN. You can configure multiple FCF trusted interfaces in a VLAN.
- A maximum of eight VLANs are supported for FIP snooping on the switch. When enabled globally, FIP snooping processes FIP packets in traffic only from the first eight incoming VLANs. When enabled on a per-VLAN basis, FIP snooping is supported on up to eight VLANs.

Configuring the FC-MAP Value

You can configure the FC-MAP value to be applied globally by the switch on all or individual FCoE VLANs to authorize FCoE traffic.

The configured FC-MAP value is used to check the FC-MAP value for the MAC address assigned to ENodes in incoming FCoE frames. If the FC-MAP value does not match, FCoE frames are dropped. A session between an ENode and an FCF is established by the switch-bridge only when the FC-MAP value on the FCF matches the FC-MAP value on the FIP snooping bridge.

Configuring a Port for a Bridge-to-Bridge Link

If a switch port is connected to another FIP snooping bridge, configure the FCoE-Trusted Port mode for bridge-bridge links. Initially, all FCoE traffic is blocked. Only FIP frames with the ALL_FCF_MAC and ALL_ENODE_MAC values in their headers are allowed to pass. After the switch learns the MAC address of a connected FCF, it allows FIP frames destined to or received from the FCF MAC address.

FCoE traffic is allowed on the port only after the switch learns the FC-MAP value associated with the specified FCF MAC address and verifies that it matches the configured FC-MAP value for the FCoE VLAN.

Configuring a Port for a Bridge-to-FCF Link

If a port is directly connected to an FCF, configure the port mode as FCF. Initially, all FCoE traffic is blocked; only FIP frames are allowed to pass.

FCoE traffic is allowed on the port only after a successful FLOGI request/response and confirmed use of the configured FC-MAP value for the VLAN.

Impact on Other Software Features

When you enable FIP snooping on a switch, other software features are impacted as follows:

- **MAC address learning:** MAC address learning is not performed on FIP and FCoE frames, which are denied by ACLs dynamically created by FIP snooping on server-facing ports in ENode mode.
- **MTU auto-configuration:** MTU size is set to mini-jumbo (2500 bytes) when a port is in Switchport mode, the FIP snooping feature is enabled on the switch, and FIP snooping is enabled on all or individual VLANs.
- **Link aggregation group (LAG):** FIP snooping is supported on port channels on ports on which PFC mode is on (PFC is operationally up).
- **STP:** If you enable an STP protocol (STP, RSTP, PVSTP, or MSTP) on the switch and ports enter a blocking state, when the state change occurs, the corresponding port-based ACLs are deleted. If a port is enabled for FIP snooping in ENode or FCF mode, the ENode/FCF MAC-based ACLs are deleted.

FIP Snooping Prerequisites

Before you configure FIP snooping on a switch, ensure that the following conditions are met:

- A FIP snooping bridge requires DCBX and PFC to be enabled on the switch for lossless Ethernet connections (refer to the [Data Center Bridging \(DCB\)](#) chapter). Dell Force10 recommends that you also enable ETS; ETS is recommended but not required.

If you enable DCBX and PFC mode is on (PFC is operationally up) in a port configuration, FIP snooping is operational on the port. If the PFC parameters in a DCBX exchange with a peer are not synchronized, FIP and FCoE frames are dropped on the port after you enable the FIP snooping feature.

- VLAN membership:
 - You must create the VLANs on the switch which handles FCoE traffic (**interface vlan** command).
 - You must configure each FIP snooping port to operate in Hybrid mode so that it accepts both tagged and untagged VLAN frames (**portmode hybrid** command).
 - You must configure tagged VLAN membership on each FIP snooping port that sends and receives FCoE traffic and has links with an FCF, ENode server, or another FIP snooping bridge (**tagged port-type slot/port** command).

The default VLAN membership of the port should continue to operate with untagged frames. FIP snooping is not supported on a port that is configured for non-default untagged VLAN membership.

FIP Snooping Restrictions

The following restrictions apply when you configure FIP snooping:

- The maximum number of FCoE VLANs supported on the switch is 8.
- The maximum number of FIP snooping sessions supported per ENode server is 16.
- The maximum number of FCFs supported per FIP snooping-enabled VLAN is 4.

Configuration Procedure

You can enable FIP snooping globally on all FCoE VLANs on a switch or on an individual FCoE VLAN. By default, FIP snooping is disabled.

To enable FIP snooping on the switch and configure FIP snooping parameters on ports, follow these steps:

| Step | Task | Command | Command Mode |
|------|--|--|---------------------------------------|
| 1 | Configure FCoE. The configuration files are stored in the flash memory in the CONFIG_TEMPLATE file. Note: DCB/DCBx will be enabled when either of these configurations is applied. | FCoE configuration: copy flash:/ CONFIG_TEMPLATE/ FCoE_DCB_Config running-config | |
| 2 | Save the configuration on the switch. | write memory | EXEC Privilege |
| 3 | Reload the switch to enable the configuration. After the switch is reloaded, DCB/DCBX will be enabled. | reload | EXEC Privilege |
| 4 | Enable the FIP snooping feature on a switch. | feature fip-snooping | CONFIGURATION |
| 5 | Enable FIP snooping on all VLANs or on a specified VLAN. | fip-snooping enable | CONFIGURATION Or VLAN INTERFACE |
| 6 | Configure the port for bridge-to-FCF links. | fip-snooping port-mode fcf | INTERFACE CONFIGURATION |



Note: To disable the FIP snooping feature or FIP snooping on VLANs, use the **no** version of a command; for example, **no feature fip-snooping** or **no fip-snooping enable**.

Displaying FIP Snooping Information

Use the **show** commands in [Table 17-1](#) to display information on FIP snooping.

Table 17-1. Displaying FIP Snooping Information

| Command | Output |
|---|---|
| show fip-snooping sessions [<i>interface vlan vlan-id</i>] | Displays information on FIP-snooped sessions on all VLANs or a specified VLAN, including the ENode interface and MAC address, the FCF interface and MAC address, VLAN ID, FCoE MAC address and FCoE session ID number (FC-ID), worldwide node name (WWNN) and the worldwide port name (WWPN). |
| show fip-snooping config | Displays the FIP snooping status and configured FC-MAP values. |
| show fip-snooping enode [<i>enode-mac-address</i>] | Displays information on the ENodes in FIP-snooped sessions, including the ENode interface and MAC address, FCF MAC address, VLAN ID and FC-ID. |
| show fip-snooping fcf [<i>fcf-mac-address</i>] | Displays information on the FCFs in FIP-snooped sessions, including the FCF interface and MAC address, FCF interface, VLAN ID, FC-MAP value, FKA advertisement period, and number of ENodes connected. |
| clear fip-snooping database interface vlan <i>vlan-id</i> { <i>fcoc-mac-address</i> <i>enode-mac-address</i> <i>fcf-mac-address</i> } | Clears FIP snooping information on a VLAN for a specified FCoE MAC address, ENode MAC address, or FCF MAC address, and removes the corresponding ACLs generated by FIP snooping. |
| show fip-snooping statistics [<i>interface vlan vlan-id</i> <i>interface port-type port/slot</i> <i>interface port-channel port-channel-number</i>] | Displays statistics on the FIP packets snooped on all interfaces, including VLANs, physical ports, and port channels. |
| clear fip-snooping statistics [<i>interface vlan vlan-id</i> <i>interface port-type port/slot</i> <i>interface port-channel port-channel-number</i>] | Clears the statistics on the FIP packets snooped on all VLANs, a specified VLAN, or a specified port interface. |
| show fip-snooping system | Display information on the status of FIP snooping on the switch (enabled or disabled), including the number of FCoE VLANs, FCFs, ENodes, and currently active sessions. |
| show fip-snooping vlan | Display information on the FCoE VLANs on which FIP snooping is enabled. |

Figure 17-3. show fip-snooping sessions Command Example

```

FTOS#show fip-snooping sessions
Enode MAC           Enode Intf         FCF MAC           FCF Intf          VLAN
aa:bb:cc:00:00:00   Te 0/42            aa:bb:cd:00:00:00 Te 0/43            100
aa:bb:cc:00:00:00   Te 0/42            aa:bb:cd:00:00:00 Te 0/43            100
aa:bb:cc:00:00:00   Te 0/42            aa:bb:cd:00:00:00 Te 0/43            100
aa:bb:cc:00:00:00   Te 0/42            aa:bb:cd:00:00:00 Te 0/43            100
aa:bb:cc:00:00:00   Te 0/42            aa:bb:cd:00:00:00 Te 0/43            100

FCoE MAC           FC-ID             Port WWPN          Port WWNN
0e:fc:00:01:00:01   01:00:01         31:00:0e:fc:00:00:00:00  21:00:0e:fc:00:00:00:00
0e:fc:00:01:00:02   01:00:02         41:00:0e:fc:00:00:00:00  21:00:0e:fc:00:00:00:00
0e:fc:00:01:00:03   01:00:03         41:00:0e:fc:00:00:00:01  21:00:0e:fc:00:00:00:00
0e:fc:00:01:00:04   01:00:04         41:00:0e:fc:00:00:00:02  21:00:0e:fc:00:00:00:00
0e:fc:00:01:00:05   01:00:05         41:00:0e:fc:00:00:00:03  21:00:0e:fc:00:00:00:00

```

Table 17-2. show fip-snooping sessions Command Description

| Field | Description |
|-----------------|---|
| ENode MAC | MAC address of the ENode. |
| ENode Interface | Slot/ port number of the interface connected to the ENode. |
| FCF MAC | MAC address of the FCF. |
| FCF Interface | Slot/ port number of the interface to which the FCF is connected. |
| VLAN | VLAN ID number used by the session. |
| FCoE MAC | MAC address of the FCoE session assigned by the FCF. |
| FC-ID | Fibre Channel ID assigned by the FCF. |
| Port WWPN | Worldwide port name of the CNA port. |
| Port WWNN | Worldwide node name of the CNA port. |

Figure 17-4. show fip-snooping config Command Example

```
FTOS# show fip-snooping config
FIP Snooping Feature enabled Status: Enabled
FIP Snooping Global enabled Status: Enabled
Global FC-MAP Value: 0X0EFC00
```

```
FIP Snooping enabled VLANs
VLAN    Enabled      FC-MAP
----    -
100     TRUE            0X0EFC00
```

Figure 17-5. show fip-snooping enode Command Example

```
FTOS# show fip-snooping enode
Enode MAC      Enode Interface  FCF MAC          VLAN    FC-ID
-----
d4:ae:52:1b:e3:cd  Te 0/11         54:7f:ee:37:34:40  100     62:00:11
```

Table 17-3. show fip-snooping enode Command Description

| Field | Description |
|-----------------|--|
| ENode MAC | MAC address of the ENode. |
| ENode Interface | Slot/ port number of the interface connected to the ENode. |
| FCF MAC | MAC address of the FCF. |
| VLAN | VLAN ID number used by the session. |
| FC-ID | Fibre Channel session ID assigned by the FCF. |

Figure 17-6. show fip-snooping fcf Command Example

```
FTOS# show fip-snooping fcf
FCF MAC           FCF Interface    VLAN    FC-MAP    FKA_ADV_PERIOD  No. of Enodes
-----
54:7f:ee:37:34:40 Po 22           100     0e:fc:00  4000           2
```

Table 17-4. show fip-snooping fcf Command Description

| Field | Description |
|-----------------|--|
| FCF MAC | MAC address of the FCF. |
| FCF Interface | Slot/port number of the interface to which the FCF is connected. |
| VLAN | VLAN ID number used by the session. |
| FC-MAP | FC-Map value advertised by the FCF. |
| ENode Interface | Slot/ number of the interface connected to the ENode. |
| FKA_ADV_PERIOD | Period of time (in milliseconds) during which FIP keep-alive advertisements are transmitted. |
| No of ENodes | Number of ENodes connected to the FCF. |
| FC-ID | Fibre Channel session ID assigned by the FCF. |

Figure 17-7. show fip-snooping statistics (VLAN and port) Command Example

```

FTOS# show fip-snooping statistics interface vlan 100
Number of Vlan Requests                :0
Number of Vlan Notifications           :0
Number of Multicast Discovery Solicits  :2
Number of Unicast Discovery Solicits    :0
Number of FLOGI                        :2
Number of FDISC                         :16
Number of FLOGO                          :0
Number of Enode Keep Alive              :9021
Number of VN Port Keep Alive            :3349
Number of Multicast Discovery Advertisement :4437
Number of Unicast Discovery Advertisement :2
Number of FLOGI Accepts                  :2
Number of FLOGI Rejects                  :0
Number of FDISC Accepts                  :16
Number of FDISC Rejects                  :0
Number of FLOGO Accepts                  :0
Number of FLOGO Rejects                  :0
Number of CVL                           :0
Number of FCF Discovery Timeouts         :0
Number of VN Port Session Timeouts      :0
Number of Session failures due to Hardware Config :0
FTOS(conf)#

FTOS# show fip-snooping statistics int tengigabitethernet 0/11
Number of Vlan Requests                :1
Number of Vlan Notifications           :0
Number of Multicast Discovery Solicits  :1
Number of Unicast Discovery Solicits    :0
Number of FLOGI                        :1
Number of FDISC                         :16
Number of FLOGO                          :0
Number of Enode Keep Alive              :4416
Number of VN Port Keep Alive            :3136
Number of Multicast Discovery Advertisement :0
Number of Unicast Discovery Advertisement :0
Number of FLOGI Accepts                  :0
Number of FLOGI Rejects                  :0
Number of FDISC Accepts                  :0
Number of FDISC Rejects                  :0
Number of FLOGO Accepts                  :0
Number of FLOGO Rejects                  :0
Number of CVL                           :0
Number of FCF Discovery Timeouts         :0
Number of VN Port Session Timeouts      :0
Number of Session failures due to Hardware Config :0

```

Figure 17-8. show fip-snooping statistics (port channel) Command Example

```

FTOS# show fip-snooping statistics interface port-channel 22
Number of Vlan Requests                               :0
Number of Vlan Notifications                         :2
Number of Multicast Discovery Solicits               :0
Number of Unicast Discovery Solicits                :0
Number of FLOGI                                     :0
Number of FDISC                                     :0
Number of FLOGO                                     :0
Number of Enode Keep Alive                          :0
Number of VN Port Keep Alive                        :0
Number of Multicast Discovery Advertisement          :4451
Number of Unicast Discovery Advertisement           :2
Number of FLOGI Accepts                             :2
Number of FLOGI Rejects                             :0
Number of FDISC Accepts                             :16
Number of FDISC Rejects                             :0
Number of FLOGO Accepts                             :0
Number of FLOGO Rejects                             :0
Number of CVL                                       :0
Number of FCF Discovery Timeouts                    :0
Number of VN Port Session Timeouts                  :0
Number of Session failures due to Hardware Config    :0

```

Table 17-5. show fip-snooping statistics Command Descriptions

| Field | Description |
|--|---|
| Number of VLAN Requests | Number of FIP-snooped VLAN request frames received on the interface. |
| Number of VLAN Notifications | Number of FIP-snooped VLAN notification frames received on the interface. |
| Number of Multicast Discovery Solicits | Number of FIP-snooped multicast discovery solicit frames received on the interface. |
| Number of Unicast Discovery Solicits | Number of FIP-snooped unicast discovery solicit frames received on the interface. |
| Number of FLOGI | Number of FIP-snooped FLOGI request frames received on the interface. |
| Number of FDISC | Number of FIP-snooped FDISC request frames received on the interface. |
| Number of FLOGO | Number of FIP-snooped FLOGO frames received on the interface. |
| Number of ENode Keep Alives | Number of FIP-snooped ENode keep-alive frames received on the interface. |
| Number of VN Port Keep Alives | Number of FIP-snooped VN port keep-alive frames received on the interface. |
| Number of Multicast Discovery Advertisements | Number of FIP-snooped multicast discovery advertisements received on the interface. |
| Number of Unicast Discovery Advertisements | Number of FIP-snooped unicast discovery advertisements received on the interface. |
| Number of FLOGI Accepts | Number of FIP FLOGI accept frames received on the interface. |
| Number of FLOGI Rejects | Number of FIP FLOGI reject frames received on the interface. |
| Number of FDISC Accepts | Number of FIP FDISC accept frames received on the interface. |

Table 17-5. show fip-snooping statistics Command Descriptions

| Field | Description |
|---|--|
| Number of FDISC Rejects | Number of FIP FDISC reject frames received on the interface. |
| Number of FLOGO Accepts | Number of FIP FLOGO accept frames received on the interface. |
| Number of FLOGO Rejects | Number of FIP FLOGO reject frames received on the interface. |
| Number of CVLs | Number of FIP clear virtual link frames received on the interface. |
| Number of FCF Discovery Timeouts | Number of FCF discovery timeouts that occurred on the interface. |
| Number of VN Port Session Timeouts | Number of VN port session timeouts that occurred on the interface. |
| Number of Session failures due to Hardware Config | Number of session failures due to hardware configuration that occurred on the interface. |

Figure 17-9. show fip-snooping system Command Example

```

FTOS# show fip-snooping system
Global Mode           : Enabled
FCOE VLAN List (Operational) : 1, 100
FCFs                  : 1
Enodes                : 2
Sessions              : 17

```

Figure 17-10. show fip-snooping vlan Command Example

```

FTOS# show fip-snooping vlan
* = Default VLAN

VLAN   FC-MAP           FCFs   Enodes  Sessions
----   -
*1     -                 -      -       -
100    0X0EFC00          1      2       17

```

FIP Snooping Configuration Example

Figure 17-11 shows a S4810 switch used as a FIP snooping bridge for FCoE traffic between an ENode (server blade) and an FCF (ToR switch). The ToR switch operates as an FCF and FCoE gateway.

Note: This example shows S4820, but also applies to the S4820T platform.

Figure 17-11. Configuration Example: FIP Snooping on an S4810 Switch

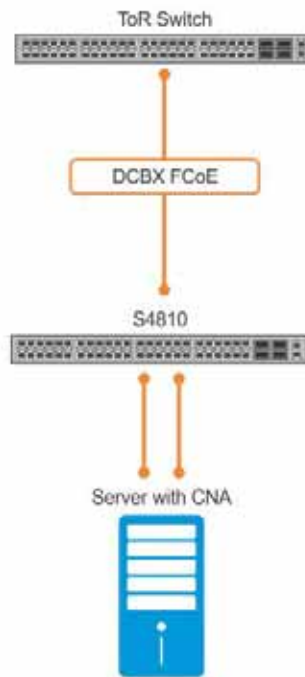

In [Figure 17-11](#), DCBX and PFC are enabled on the FIP snooping bridge and on the FCF ToR switch. On the FIP snooping bridge, DCBX is configured as follows:

- A server-facing port is configured for DCBX in an auto-downstream role.
- An FCF-facing port is configured for DCBX in an auto-upstream or configuration-source role.

The DCBX configuration on the FCF-facing port is detected by the server-facing port and the DCB PFC configuration on both ports is synchronized. For more information about how to configure DCBX and PFC on a port, refer to [Data Center Bridging \(DCB\)](#).

[Figure 17-12](#) shows how to configure FIP snooping on FCoE VLAN 10, on an FCF-facing port (0/50), on an ENode server-facing port (0/1), and to configure the FIP snooping ports as tagged members of the FCoE VLAN enabled for FIP snooping.

Figure 17-12. FIP Snooping Configuration Example

Enable the FIP snooping feature on the switch (FIP snooping bridge):

```
FTOS(conf)# feature fip-snooping
```

Enable FIP snooping on FCoE VLAN 10:

```
FTOS(conf)# interface vlan 10
FTOS(conf-if-vl-10)# fip-snooping enable
```

Enable an FC-MAP value on VLAN 10:

```
FTOS(conf-if-vl-10)# fip-snooping fc-map 0x0EFC01
```

Note: Configuring an FC-MAP value is only required if you do not use the default FC-MAP value (0x0EFC00).

Configure the ENode server-facing port:

```
FTOS(conf)# interface tengigabitethernet 0/1
FTOS(conf-if-te-0/1)# portmode hybrid
FTOS(conf-if-te-0/1)# switchport
FTOS(conf-if-te-0/1)# protocol lldp
FTOS(conf-if-te-0/1-lldp)# dcbx port-role auto-downstream
```

Note: A port is enabled by default for bridge-ENode links.

Configure the FCF-facing port:

```
FTOS(conf)# interface tengigabitethernet 0/50
FTOS(conf-if-te-0/50)# portmode hybrid
FTOS(conf-if-te-0/50)# switchport
FTOS(conf-if-te-0/50)# fip-snooping port-mode fcf
FTOS(conf-if-te-0/50)# protocol lldp
FTOS(conf-if-te-0/50-lldp)# dcbx port-role auto-upstream
```

Configure FIP snooping ports as tagged members of FCoE VLAN:

```
FTOS(conf)# interface vlan 10
FTOS(conf-if-vl-10)# tagged tengigabitethernet 0/1
FTOS(conf-if-vl-10)# tagged tengigabitethernet 0/50
FTOS(conf-if-te-0/1)# no shut
FTOS(conf-if-te-0/50)# no shut
FTOS(conf-if-vl-10)# no shut
```

After FIP packets are exchanged between the ENode and the switch, a FIP snooping session is established. ACLS are dynamically generated for FIP snooping on the FIP snooping bridge/switch.

Force10 Resilient Ring Protocol (FRRP)

Force10 Resilient Ring Protocol (FRRP) is supported on platforms:  

Force10 Resilient Ring Protocol (FRRP) provides fast network convergence to Layer 2 switches interconnected in a ring topology, such as a Metropolitan Area Network (MAN) or large campuses. FRRP is similar to what can be achieved with the Spanning Tree Protocol (STP), though even with optimizations, STP can take up to 50 seconds to converge (depending on the size of network and node of failure) may require 4 to 5 seconds to reconverge. FRRP can converge within 150ms to 1500ms when a link in the ring breaks (depending on network configuration).

To operate a deterministic network, a network administrator must run a protocol that converges independently of the network size or node of failure. The Force10 Resilient Ring Protocol (FRRP) is a proprietary protocol that provides this flexibility, while preventing Layer 2 loops. FRRP provides sub-second ring-failure detection and convergence/re-convergence in a Layer 2 network while eliminating the need for running spanning-tree protocol. With its two-way path to destination configuration, FRRP provides protection against any single link/switch failure and thus provides for greater network uptime.

Protocol Overview

FRRP is built on a ring topology. Up to 255 rings can be configured on a system. FRRP uses one Master node and multiple Transit nodes in each ring. There is no limit to the number of nodes on a ring. The Master node is responsible for the intelligence of the Ring and monitors the status of the Ring. The Master node checks the status of the Ring by sending Ring Health Frames (RHF) around the Ring from its Primary port and returning on its Secondary port. If the Master node misses three consecutive RHF's, it determines the ring to be in a failed state. The Master then sends a Topology Change RHF to the Transit Nodes informing them that the ring has changed. This causes the Transit Nodes to flush their forwarding tables, and re-converge to the new network structure.

One port of the Master node is designated the Primary port (P) to the ring; another port is designated as the Secondary port (S) to the ring. In normal operation, the Master node blocks the Secondary port for all non-control traffic belonging to this FRRP group, thereby avoiding a loop in the ring, like STP. Layer 2 switching and learning mechanisms operate per existing standards on this ring.

Each Transit node is also configured with a Primary port and a Secondary port on the ring, but the port distinction is ignored as long as the node is configured as a Transit node. If the ring is complete, the Master node logically blocks all data traffic in the transmit and receive directions on the Secondary port to prevent a loop. If the Master node detects a break in the ring, it unblocks its Secondary port and allows data traffic to be transmitted and received through it. Refer to the illustration below for a simple example of this FRRP topology. Note that ring direction is determined by the Master node's Primary and Secondary ports.

A Virtual LAN (VLAN) is configured on all node ports in the ring. All ring ports must be members of the Member VLAN and the Control VLAN.

The Member VLAN is the VLAN used to transmit data as described earlier.

The Control VLAN is used to perform the health checks on the ring. The Control VLAN can always pass through all ports in the ring, including the secondary port of the Master node.

Ring Status

The Ring Failure notification and the Ring Status checks provide two ways to ensure the ring remains up and active in the event of a switch or port failure.

Ring Checking

At specified intervals, the Master Node sends a Ring Health Frame (RHF) through the ring. If the ring is complete, the frame is received on its secondary port and the Master node resets its fail-period timer and continues normal operation.

If the Master node does not receive the Ring Health Frame (RHF) before the fail-period timer expires (a configurable timer), the Master node moves from the Normal state to the Ring-Fault state and unblocks its Secondary port. The Master node also clears its forwarding table and sends a control frame to all other nodes, instructing them to also clear their forwarding tables. Immediately after clearing its forwarding table, each node starts learning the new topology.

Ring Failure

If a Transit node detects a link down on any of its ports on the FRRP ring, it immediately sends a link-down control frame on the Control VLAN to the Master node. When the Master node receives this control frame, the Master node moves from the Normal state to the Ring-Fault state and unblocks its Secondary port. The Master node clears its routing table and sends a control frame to all other ring nodes, instructing them to clear their routing tables as well. Immediately after clearing its routing table, each node begins learning the new topology.

Ring Restoration

The Master node continues sending Ring Health Frames out its primary port even when operating in the Ring-Fault state. Once the ring is restored, the next status check frame is received on the Master node's Secondary port. This will cause the Master node to transition back to the Normal state. The Master node then logically blocks non-control frames on the Secondary port, clears its own forwarding table, and sends a control frame to the Transit nodes, instructing them to clear their forwarding tables and re-learn the topology.

During the time between the Transit node detecting that its link is restored and the Master node detecting that the ring is restored, the Master node's Secondary port is still forwarding traffic. This can create a temporary loop in the topology. To prevent this, the Transit node places all the ring ports transiting the newly restored port into a temporary blocked state. The Transit node remembers which port has been temporarily blocked and places it into a pre-forwarding state. When the Transit node in the pre-forwarding state receives the control frame instructing it to clear its routing table, it does so and unblocks the previously blocked ring ports on the newly restored port. Then the Transit node returns to the Normal state.

Multiple FRRP Rings

Up to 255 rings are allowed per system and multiple rings can be run on one system. However, it is not recommended on the S20/S50 to have more than 34 rings on the same interface (either a physical interface or a portchannel). More than the recommended number of rings may cause interface instability. Multiple rings can be configured with a single switch connection; a single ring can have multiple FRRP groups; multiple rings can be connected with a common link.

The S4810, S4820T, S55, and S60 support up to 32 rings on a system (including stacked units).

Member VLAN Spanning Two Rings Connected by One Switch

A Member VLAN can span two rings interconnected by a common switch, in a figure-eight style topology. A switch can act as a Master node for one FRRP Group and a Transit for another FRRP group, or it can be a Transit node for both rings.

In the example shown below, FRRP 101 is a ring with its own Control VLAN, and FRRP 202 has its own Control VLAN running on another ring. A Member VLAN that spans both rings is added as a Member VLAN to both FRRP groups. Switch R3 has two instances of FRRP running on it: one for each ring. The example topology that follows shows R3 assuming the role of a Transit node for both FRRP 101 and FRRP 202.

Important FRRP Points

FRRP provides a convergence time that can generally range between 150ms and 1500ms for Layer 2 networks. The master node originates a high-speed frame that circulates around the ring. This frame, appropriately, sets up or breaks down the ring.

- Ring Status Check Frames are transmitted by the Master Node at specified intervals
- Multiple physical rings can be run on the same switch
- One Master node per ring—all other nodes are Transit

- Each node has 2 member interfaces—Primary, Secondary
- No limit to the number of nodes on a ring
- Master node ring port states—blocking, pre-forwarding, forwarding, disabled
- Transit node ring port states—blocking, pre-forwarding, forwarding, disabled
- STP disabled on ring interfaces
- Master node secondary port is in blocking state during Normal operation
- Ring Health Frames (RHF)
 - Hello RHF
 - Sent at 500ms (hello interval)
 - Transmitted and processed by Master node only
 - Topology Change RHF
 - Triggered updates
 - Processed at all nodes

Important FRRP Concepts

Table 18-1, "FRRP Components," in Force10 Resilient Ring Protocol (FRRP) lists some important FRRP concepts.

Table 18-1. FRRP Components

| Concept | Explanation |
|--------------|---|
| Ring ID | Each <i>ring</i> has a unique 8-bit ring ID through which the ring is identified (e.g. FRRP 101 and FRRP 202 as shown in the illustration in Member VLAN Spanning Two Rings Connected by One Switch). |
| Control VLAN | Each <i>ring</i> has a unique Control VLAN through which tagged Ring Health Frames (RHF) are sent. Control VLANs are used only for sending Ring Health Frames, and cannot be used for any other purpose. |
| Member VLAN | Each <i>ring</i> maintains a list of member VLANs. Member VLANs must be consistent across the entire ring. |
| Port Role | Each <i>node</i> has two ports for each ring: Primary and Secondary. The Master node Primary port generates Ring Health Frames (RHF). The Master node Secondary port receives the RHF frames. On Transit nodes, there is no distinction between a Primary and Secondary interface when operating in the Normal state. |

Table 18-1. FRRP Components (continued)

| Concept | Explanation |
|-------------------------------|---|
| Ring Interface State | <p>Each interface (<i>port</i>) that is part of the ring maintains one of four states</p> <ul style="list-style-type: none"> • Blocking State: Accepts ring protocol packets but blocks data packets. LLDP, FEFD, or other Layer 2 control packets are accepted. Only the master node Secondary port can enter this state. • Pre-Forwarding State: A transition state before moving to the Forward state. Control traffic is forwarded but data traffic is blocked. The Master node Secondary port transitions through this state during ring bring-up. All ports transition through this state when a port comes up. • Forwarding State—Both ring control and data traffic is passed. When the ring is in Normal operation, the Primary port on the Master node and both Primary and Secondary ports on the Transit nodes are in forwarding state. When the ring is broken, all ring ports are in this state. • Disabled State—When the port is disabled or down, or is not on the VLAN. |
| Ring Protocol Timers | <p>Hello Interval: The interval when ring frames are generated from the Master node’s Primary interface (default 500 ms). The Hello interval is configurable in 50 ms increments from 50 ms to 2000 ms.</p> <p>Dead Interval: The interval when data traffic is blocked on a port. The default is 3 times the Hello interval rate. The dead interval is configurable in 50 ms increments from 50 ms to 6000 ms.</p> |
| Ring Status | <p>The state of the FRRP ring. During initialization/configuration, the default ring status is Ring-down (disabled). The Primary and Secondary interfaces, Control VLAN, and Master and Transit node information must be configured for the ring to be up.</p> <ul style="list-style-type: none"> • Ring-Up: Ring is up and operational • Ring-Down: Ring is broken or not set up |
| Ring Health-check Frame (RHF) | <p>Two types of RHF are generated by the Master node. RHF never loop the ring because they terminate at the Master node’s secondary port.</p> <ul style="list-style-type: none"> • Hello RHF (HRHF): These frames are processed only on the Master node’s Secondary port. The Transit nodes pass the HRHF through the without processing it. An HRHF is sent at every Hello interval. • Topology Change RHF (TCRHF): These frames contains ring status, keealive, and the Control and Member VLAN hash. It is processed at each node of the ring. TCRHFs are sent out the Master Node’s Primary and Secondary interface when the ring is declared in a Failed state with the same sequence number, on any topology change to ensure all Transit nodes receive it. There is no periodic transmission of TCRHFs. The TCRHFs are sent on triggered events of ring failure or ring restoration only. |

Implementing FRRP

- FRRP is media and speed independent.
- FRRP is a Dell Force10 proprietary protocol that does not interoperate with any other vendor.
- Spanning Tree must be disabled on both Primary and Secondary interfaces before FRRP is enabled.
- All ring ports must be Layer 2 ports. This is required for both Master and Transit nodes.
- A VLAN configured as control VLAN for a ring cannot be configured as a control or member VLAN for any other ring.

- The Control VLAN is used to carry any data traffic; it carries only RHF's.
- The Control VLAN cannot have members that are not ring ports.
- If multiple rings share one or more member VLANs, they cannot share any links between them.
- Member VLANs across multiple rings are not supported in Master nodes.
- Each ring has only one Master node; all others are transit nodes.

FRRP Configuration

These are the tasks to configure FRRP.

- [Create the FRRP group](#)
- [Configure the Control VLAN](#)
 - Configure Primary and Secondary ports
- [Configure and add the Member VLANs](#)
 - Configure Primary and Secondary ports
- [Configure the Master node](#)
- [Configure a Transit node](#)
- [Set FRRP Timers \(optional\)](#)
- [Enable FRRP](#)

Other FRRP related commands are:

- [Clear FRRP counters](#)

Create the FRRP group

The FRRP group must be created on each switch in the ring.

Use the commands in the following sequence to create the FRRP group.

| Command Syntax | Command Mode | Purpose |
|-----------------------------------|---------------|---|
| <code>protocol frp ring-id</code> | CONFIGURATION | Create the FRRP group with this Ring ID Ring ID: 1-255 |

Configure the Control VLAN

Control and Member VLANS are configured normally for Layer 2. Their status as Control or Member is determined at the FRRP group commands. For complete information about configuring VLANS in Layer 2 mode, refer to [Layer 2](#).

Be sure to follow these guidelines:

- All VLANs must be in Layer 2 mode.
- Only ring nodes can be added to the VLAN.
- A Control VLAN can belong to one FRRP group only.
- Control VLAN ports must be tagged.
- All ports on the ring must use the same VLAN ID for the Control VLAN.
- A VLAN cannot be configured as both a Control VLAN and Member VLAN on the same ring.
- Only two interfaces can be members of a Control VLAN (the Master Primary and Secondary ports).
- Member VLANs across multiple rings are not supported in Master nodes

Use the commands in the following sequence, on the switch that will act as the Master node, to create the Control VLAN for this FRRP group.

| Step | Command Syntax | Command Mode | Purpose |
|------|---|-----------------|--|
| 1 | interface vlan <i>vlan-id</i> | CONFIGURATION | Create a VLAN with this ID number VLAN ID: 1-4094 |
| 2 | tagged <i>interface slot/ port {range}</i> | CONFIG-INT-VLAN | Tag the specified interface or range of interfaces to this VLAN. Interface: <ul style="list-style-type: none"> • For a 10/100/1000 Ethernet interface, enter the keyword GigabitEthernet followed by the slot/port information. • For a Gigabit Ethernet interface, enter the keyword GigabitEthernet followed by the slot/port information • For a 10 Gigabit Ethernet interface, enter the keyword TenGigabitEthernet followed by the slot/port information. • For a 40-Gigabit Ethernet interface, enter the keyword fortyGigE followed by the slot/port information. Slot/Port, Range: Slot and Port ID for the interface. Range is entered Slot/Port-Port. |

| Step | Command Syntax | Command Mode | Purpose |
|------|--|--------------|--|
| 3 | interface primary <i>int slot/port</i> secondary <i>int slot/port</i> control-vlan <i>vlan id</i> | CONFIG-FRRP | Assign the Primary and Secondary ports, and the Control VLAN for the ports on the ring. Interface: <ul style="list-style-type: none"> For a 10/100/1000 Ethernet interface, enter the keyword <code>keyword GigabitEthernet</code> followed by the slot/port information. For a Gigabit Ethernet interface, enter the keyword <code>GigabitEthernet</code> followed by the slot/port information For a SONET interface, enter the keyword <code>sonet</code> followed by slot/port information. For a 10 Gigabit Ethernet interface, enter the keyword <code>TenGigabitEthernet</code> followed by the slot/port information. For a 40-Gigabit Ethernet interface, enter the keyword fortyGigE followed by the slot/port information. Slot/Port: Slot and Port ID for the interface. VLAN ID: The VLAN identification of the Control VLAN. |
| 4 | mode <i>master</i> | CONFIG-FRRP | Configure the Master node |
| 5 | member-vlan <i>vlan-id {range}</i> | CONFIG-FRRP | Identify the Member VLANs for this FRRP group VLAN-ID, Range: VLAN IDs for the ring's Member VLANs. |
| 6 | no disable | CONFIG-FRRP | Enable FRRP |

Configure and add the Member VLANs

Control and Member VLANs are configured normally for Layer 2. Their status as Control or Member is determined at the FRRP group commands. For complete information about configuring VLANs in Layer 2 mode, refer to [Layer 2](#).

Be sure to follow these guidelines:

- All VLANs must be in Layer 2 mode.
- Control VLAN ports must be tagged. Member VLAN ports except the Primary/Secondary interface can be tagged or untagged.
- The Control VLAN must be the same for all nodes on the ring.

Use the commands in the following sequence, on all of the Transit switches in the ring, to create the Members VLANs for this FRRP group.

| Step | Command Syntax | Command Mode | Purpose |
|------|--------------------------------------|---------------|--|
| 1 | interface vlan <i>vlan-id</i> | CONFIGURATION | Create a VLAN with this ID number VLAN ID: 1-4094 |

| Step | Command Syntax | Command Mode | Purpose |
|------|--|-----------------|---|
| 2 | tagged <i>interface slot/port {range}</i> | CONFIG-INT-VLAN | <p>Tag the specified interface or range of interfaces to this VLAN.</p> <p>Interface:</p> <ul style="list-style-type: none"> For a 10/100/1000 Ethernet interface, enter the keyword GigabitEthernet followed by the slot/port information. For a Gigabit Ethernet interface, enter the keyword GigabitEthernet followed by the slot/port information. For a SONET interface, enter the keyword sonet followed by slot/port information. For a 10 Gigabit Ethernet interface, enter the keyword TenGigabitEthernet followed by the slot/port information. For a 40-Gigabit Ethernet interface, enter the keyword fortyGigE followed by the slot/port information. <p>Slot/Port, Range: Slot and Port ID for the interface. Range is entered Slot/Port-Port.</p> |
| 3 | interface primary <i>int slot/port</i> secondary <i>int slot/port</i> control-vlan <i>vlan id</i> | CONFIG-FRRP | <p>Assign the Primary and Secondary ports, and the Control VLAN for the ports on the ring.</p> <p>Interface:</p> <ul style="list-style-type: none"> For a 10/100/1000 Ethernet interface, enter the keyword GigabitEthernet followed by the slot/port information. For a Gigabit Ethernet interface, enter the keyword GigabitEthernet followed by the slot/port information. For a SONET interface, enter the keyword sonet followed by slot/port information. For a 10 Gigabit Ethernet interface, enter the keyword TenGigabitEthernet followed by the slot/port information. For a 40-Gigabit Ethernet interface, enter the keyword fortyGigE followed by the slot/port information. <p>Slot/Port: Slot and Port ID for the interface. VLAN ID: Identification number of the Control VLAN</p> |
| 4 | mode <i>transit</i> | CONFIG-FRRP | Configure a Transit node |
| 5 | member-vlan <i>vlan-id {range}</i> | CONFIG-FRRP | <p>Identify the Member VLANs for this FRRP group</p> <p>VLAN-ID, Range: VLAN IDs for the ring's Member VLANs.</p> |
| 6 | no disable | CONFIG-FRRP | Enable this FRRP group on this switch. |

Set FRRP Timers

| Step | Command Syntax | Command Mode | Purpose |
|------|--|--------------|--|
| 1 | timer <i>{hello-interval/dead-interval}</i> <i>milliseconds</i> | CONFIG-FRRP | Enter the desired intervals for Hello-Interval or Dead-Interval times. Hello-Interval: 50-2000, in increments of 50 (default is 500) Dead-Interval: 50-6000, in increments of 50 (default is 1500) |

The Dead-Interval time should be set at 3x the Hello-Interval.

Clear FRRP counters

Use one of the following commands to clear the FRRP counters.

| Command Syntax | Command Mode | Purpose |
|----------------------------------|-----------------|---|
| clear frrp <i>ring-id</i> | EXEC PRIVELEGED | Clear the counters associated with this Ring ID Ring ID: 1-255 |
| clear frrp | EXEC PRIVELEGED | Clear the counters associated with all FRRP groups |

Show FRRP configuration

Use the following command to view the configuration for the FRRP group.

| Command Syntax | Command Mode | Purpose |
|---------------------------|--------------|--|
| show configuration | CONFIG-FRRP | Show the configuration for this FRRP group |

Show FRRP information

Use one of the following commands show general FRRP information.

| Command Syntax | Command Mode | Purpose |
|---------------------------------|--------------------------------|---|
| show frrp <i>ring-id</i> | EXEC <i>or</i> EXEC PRIVELEGED | Show the information for the identified FRRP group. Ring ID: 1-255 |
| show frrp summary | EXEC <i>or</i> EXEC PRIVELEGED | Show the state of all FRRP groups. Ring ID: 1-255 |

Troubleshooting FRRP

Configuration Checks

- Each Control Ring must use a unique VLAN ID
- Only two interfaces on a switch can be Members of the same Control VLAN
- There can be only one Master node for any FRRP Group.
- FRRP can be configured on Layer 2 interfaces only
- Spanning Tree (if enabled globally) must be disabled on both Primary and Secondary interfaces when FRRP is enabled.
 - When the interface ceases to be a part of any FRRP process, if Spanning Tree is enabled globally, it must be enabled explicitly for the interface.
- The maximum number of rings allowed on a chassis is 255.

Sample Configuration and Topology

The following illustration is an example of a basic FRRP topology. Below the illustration are the associated CLI commands.

R1 MASTER

```
interface GigabitEthernet 1/24
  no ip address
  switchport
  no shutdown
!
interface GigabitEthernet 1/34
  no ip address
  switchport
  no shutdown
!
interface Vlan 101
  no ip address
  tagged GigabitEthernet 1/24,34
  no shutdown
!
interface Vlan 201
  no ip address
  tagged GigabitEthernet 1/24,34
  no shutdown
!
protocol frrp 101
  interface primary GigabitEthernet 1/24
  secondary GigabitEthernet 1/34 control-vlan 101
  member-vlan 201
  mode master
  no disable
```

R2 TRANSIT

```
interface GigabitEthernet 2/14
  no ip address
  switchport
```

```
no shutdown
!  
interface GigabitEthernet 2/31  
no ip address  
switchport  
no shutdown  
!  
interface Vlan 101  
no ip address  
tagged GigabitEthernet 2/14,31  
no shutdown  
!  
interface Vlan 201  
no ip address  
tagged GigabitEthernet 2/14,31  
no shutdown  
!  
protocol frrp 101  
interface primary GigabitEthernet 2/14 secondary GigabitEthernet 2/31 control-vlan 101  
member-vlan 201  
mode transit  
no disable
```

R3 TRANSIT

```
interface GigabitEthernet 3/14  
no ip address  
switchport  
no shutdown  
!  
interface GigabitEthernet 3/21  
no ip address  
switchport  
no shutdown  
!  
interface Vlan 101  
no ip address  
tagged GigabitEthernet 3/14,21  
no shutdown  
!  
interface Vlan 201  
no ip address  
tagged GigabitEthernet 3/14,21  
no shutdown  
!  
protocol frrp 101  
interface primary GigabitEthernet 3/21  
secondary GigabitEthernet 3/14 control-vlan 101  
member-vlan 201  
mode transit  
no disable
```

GARP VLAN Registration Protocol (GVRP)

GARP VLAN Registration Protocol (GVRP) is supported on platforms: `e c s` `S4810`
`S4820T`

Protocol Overview

Typical VLAN implementation involves manually configuring each Layer 2 switch that participates in a given VLAN. GARP VLAN Registration Protocol (GVRP), defined by the IEEE 802.1q specification, is a Layer 2 network protocol that provides for automatic VLAN configuration of switches. GVRP-compliant switches use GARP to register and de-register attribute values, such as VLAN IDs, with each other.

GVRP exchanges network VLAN information to allow switches to dynamically forward frames for one or more VLANs. Consequently, GVRP spreads this information and configures the needed VLAN(s) on any additional switches in the network. Data propagates via the exchange of GVRP protocol data units (PDUs).

The purpose of GVRP is to simplify (but not eliminate) static configuration. The idea is to configure switches at the edge and have the information dynamically propagate into the core. As such, the edge ports must still be statically configured with VLAN membership information, and they do not run GVRP. It is this information that is propagated to create dynamic VLAN membership in the core of the network.

Important Points to Remember

- GVRP propagates VLAN membership throughout a network. GVRP allows end stations and switches to issue and revoke declarations relating to VLAN membership.
- VLAN registration is made in the context of the port that receives the GARP PDU and is propagated to the other active ports.
- GVRP is disabled by default; you must enable GVRP for the switch and then for individual ports.
- Dynamic VLANs are aged out after the LeaveAll timer expires three times without receipt of a Join message. Use the `show gvrp statistics {interface interface | summary}` command to display status.

- On the E-Series, C-Series, and non-S60/S55/S4810/S4820T S-Series, Per-VLAN Spanning Tree (PVST+) or MSTP and GVRP cannot be enabled at the same time, as shown in the example below. If Spanning Tree and GVRP are both required, implement RSTP. The S60, S55, S4810, and S4820T systems do support enabling GVRP and MSTP at the same time.

```

FTOS(conf)#protocol spanning-tree pvst
FTOS(conf-pvst)#no disable
% Error: GVRP running. Cannot enable PVST.

.....
FTOS(conf)#protocol spanning-tree mstp
FTOS(conf-mstp)#no disable
% Error: GVRP running. Cannot enable MSTP.

.....

FTOS(conf)#protocol gvrp
FTOS(conf-gvrp)#no disable
% Error: PVST running. Cannot enable GVRP.
% Error: MSTP running. Cannot enable GVRP.

```

Configuring GVRP

Globally, enable GVRP on each switch to facilitate GVRP communications. Then, GVRP configuration is per interface on a switch-by-switch basis. Enable GVRP on each port that connects to a switch where you want GVRP information exchanged. In the illustration below, that type of port is referred to as a VLAN trunk port, but it is not necessary to specifically identify to FTOS that the port is a trunk port.

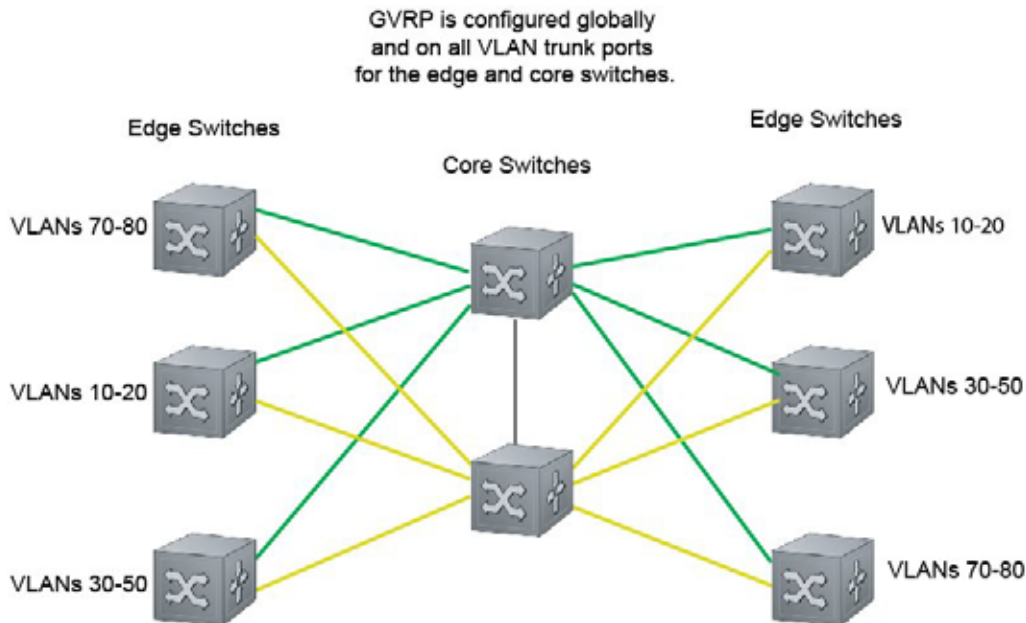

NOTES:
VLAN 1 mode is always fixed and cannot be configured
All VLAN trunk ports must be configured for GVRP
All VLAN trunk ports must be configured as 802.1Q

Basic GVRP configuration is a 2-step process:

1. [Enabling GVRP Globally.](#)
2. [Enabling GVRP on a Layer 2 Interface.](#)

Related Configuration Tasks

- [Configuring GVRP Registration](#)
- [Configuring a GARP Timer](#)

Enabling GVRP Globally

Enable GVRP for the entire switch using the command **gvrp enable** in CONFIGURATION mode, as shown in the following example. Use the **show gvrp brief** command to inspect the global configuration.

```
FTOS(conf)#protocol gvrp
FTOS(config-gvrp)#no disable
FTOS(config-gvrp)#show config
!
protocol gvrp
 no disable
FTOS(config-gvrp)#
```

Enabling GVRP on a Layer 2 Interface

Enable GVRP on a Layer 2 interface using the command **gvrp enable** in INTERFACE mode, as shown in the following example. Use **show config** from the INTERFACE mode to inspect the interface configuration, as shown in the following example, or use the **show gvrp interface** command in EXEC or EXEC Privilege mode.

```
FTOS(conf-if-gi-1/21)#switchport
FTOS(conf-if-gi-1/21)#gvrp enable
FTOS(conf-if-gi-1/21)#no shutdown
FTOS(conf-if-gi-1/21)#show config
!
interface GigabitEthernet 1/21
 no ip address
 switchport
 gvrp enable
 no shutdown
```

Configuring GVRP Registration

- **Fixed Registration Mode:** Configuring a port in fixed registration mode allows for manual creation and registration of VLANs, prevents VLAN de-registration, and registers all VLANs known on other ports on the port. For example, if an interface is statically configured via the CLI to belong to a VLAN, it should not be un-configured when it receives a Leave PDU. So, the registration mode on that interface is FIXED.
- **Forbidden Mode:** Disables the port to dynamically register VLANs, and to propagate VLAN information except information about VLAN 1. A port with forbidden registration type thus allows only VLAN 1 to pass through even though the PDU carries information for more VLANs. So, set the interface to the registration mode of FORBIDDEN if you do not want the interface to advertise or learn about particular VLANS.

Based on the configuration in the example shown below, the interface 1/21 will not be removed from VLAN 34 or VLAN 35 despite receiving a GVRP Leave message. Additionally, the interface will not be dynamically added to VLAN 45 or VLAN 46, even if a GVRP Join message is received.

```
FTOS(conf-if-gi-1/21)#gvrp registration fixed 34,35
FTOS(conf-if-gi-1/21)#gvrp registration forbidden 45,46
FTOS(conf-if-gi-1/21)#show conf
!
interface GigabitEthernet 1/21
 no ip address
 switchport
 gvrp enable
 gvrp registration fixed 34-35
 gvrp registration forbidden 45-46
 no shutdown
FTOS(conf-if-gi-1/21)#
```

Configuring a GARP Timer

GARP timers must be set to the same values on all devices that are exchanging information using GVRP:

- **Join:** A GARP device reliably transmits Join messages to other devices by sending each Join message two times. Use this parameter to define the interval between the two sending operations of each Join message. The FTOS default is 200ms.
- **Leave:** When a GARP device expects to de-register a piece of attribute information, it will send out a Leave message and start this timer. If a Join message does not arrive before the timer expires, the information is de-registered. The Leave timer must be greater than or equal to 3x the Join timer. The FTOS default is 600ms.

- **LeaveAll:** Upon startup, a GARP device globally starts a LeaveAll timer. Upon expiration of this interval, it will send out a LeaveAll message so that other GARP devices can re-register all relevant attribute information. The device then restarts the LeaveAll timer to begin a new cycle. The LeaveAll timer must be greater than or equal to 5x of the Leave timer. The FTOS default is 10000ms.

```
FTOS(conf)#garp timer leav 1000
FTOS(conf)#garp timers leave-all 5000
FTOS(conf)#garp timer join 300
```

Verification:

```
FTOS(conf)#do show garp timer
GARP Timers      Value (milliseconds)
-----
Join Timer       300
Leave Timer       1000
LeaveAll Timer    5000
FTOS(conf)#
```

FTOS displays [Message 1](#) if an attempt is made to configure an invalid GARP timer.

Message 1 GARP Timer Error

```
Force10(conf)#garp timers join 300
% Error: Leave timer should be >= 3*Join timer.
```

High Availability

High Availability (HA) is supported on platforms: C e S **S4810** **S4820T**



Note: High Availability is not supported on the S60 system.

High availability is a collection of features that preserves system continuity by maximizing uptime and minimizing packet loss during system disruptions.

To support all the features within the HA collection, you should have the latest boot code. The following table lists the boot code requirements as of this FTOS release.

| Component | Boot Code |
|------------------------------|-----------|
| E-Series TeraScale RPM | 2.4.2.1 |
| E-Series TeraScale Line Card | 2.3.2.1 |
| E-Series ExaScale RPM | 2.5.1.9 |
| E-Series ExaScale Line Card | 2.9.1.1 |
| C-Series RPM | 2.7.1.1 |
| C-Series Line Card | 2.6.0.2 |
| S-Series RPM | 2.8.2.0 |
| S-Series Line Card | 2.8.2.0 |

The features in this collection are:

- [Component Redundancy](#)
- [Online Insertion and Removal](#)
- [Hitless Behavior](#)
- [Graceful Restart](#)
- [Software Resiliency](#)
- [Warm Upgrade](#)
- [Hot-lock Behavior](#)

Component Redundancy

Dell Force10 systems eliminate single points of failure by providing dedicated or load-balanced redundancy for each component.

RPM Redundancy

The current version of FTOS supports 1+1 hitless Route Processor Module (RPM) redundancy. The primary RPM performs all routing, switching, and control operations while the standby RPM monitors the primary RPM. In the event that the primary RPM fails, the standby RPM can assume control of the system without requiring a chassis reboot.

This section contains the following sub-sections:

- [Boot the chassis with a single RPM](#)
- [Boot the chassis with dual RPMs](#)
- [Automatic and manual RPM failover](#)
- [Support for RPM redundancy by FTOS version](#)
- [RPM synchronization](#)

Boot the chassis with a single RPM

You can boot the chassis with one RPM and later add a second RPM, which automatically becomes the standby RPM. FTOS displays [Message 1](#) when the standby RPM is online.

Message 1 Standby RPM is Online

```
%RPM-2-MSG:CP0 %POLLMGR-2-ALT_RPM_STATE: Alternate RPM is present
%IRC-6-IRC_COMMUP: Link to peer RPM is up
%RAM-6-RAM_TASK: RPM1 is in Standby State.
```

On the C-Series, since the RPM also contains the switch fabric, even though the second RPM comes online as the standby, the switch fabric is active and participates in routing. You can achieve line rate on all line cards with a single RPM except for the 8-port 10G line card which requires both RPMs to achieve line rate.

Boot the chassis with dual RPMs

When you boot the system with two RPMs installed, the RPM in slot R0 is the primary RPM by default. Both RPMs should be running the same version of FTOS. You can configure either RPM to be the primary upon the next chassis reboot using the command **redundancy primary** from CONFIGURATION mode.

Version compatibility between RPMs

In general, the two RPMs should have the same FTOS version. However, FTOS tolerates some degree of difference between the two versions, as described in [Table 20-1, "System Behavior with RPMs with Mismatched FTOS Versions," in High Availability](#). View the configuration loaded on each RPM using the command **show redundancy**, as shown in the example in [Automatic and manual RPM failover](#).

Table 20-1. System Behavior with RPMs with Mismatched FTOS Versions

| Mismatch Condition | Example | Behavior |
|---|--------------------------------------|---|
| different FTOS versions with only first two digits matching | Primary: 7.4.2.0 Standby: 7.4.1.0 | The link to the standby RPM is up, and FTOS block syncs only the startup-config. The failover type is warm upgrade. FTOS displays Message 2 . |
| different FTOS versions with first two digits not matching | Primary: 7.6.1.0 Standby: 7.5.1.0 | The link to the standby RPM is down, and the standby RPM is in a boot loop. FTOS displays Message 3 and a boot fail prompt. |
| different FTOS versions with only first three digits matching | Primary: 7.4.2.0 Standby: 7.4.2.1 | The link to the peer RPM is up, and FTOS performs a complete block sync. The failover type is hot failover. FTOS displays Message 2 . |

Message 2 FTOS Version Incompatibility Error

```

*****
*
*   Warning !!!  Warning !!!  Warning !!!
*
* -----
*
*   Incompatible SW Version detected !!
*
*   This RPM -> 7.4.2.0
*   Peer RPM -> 7.4.1.0
*
*****

00:00:12: %RPM0-U:CP %IRC-4-IRC_VERSION: Current RPM 7.4.2.0 Peer RPM 7.4.1.0 -
Different software version detected
00:00:12: %RPM0-U:CP %IRC-6-IRC_COMMUP: Link to peer RPM is up
00:00:14: %RPM0-U:CP %RAM-6-ELECTION_ROLE: RPM0 is transitioning to Primary RPM.

```

Message 3 Boot Failure on Standby RPM

```

System failed to boot up. Please reboot the chassis !!!
00:12:46: %RPM1-U:CP %TME-0-RPM BRINGUP FAIL: FTOS failed to bring up the system
Communication between RPMs is not up, check the software version and reboot chassis.

FTOS(standby) (bootfail)#

```

Automatic and manual RPM failover

RPM failover is the process of the standby RPM becoming the primary RPM. FTOS fails over to the standby RPM when:

1. Communication is lost between the standby and primary RPMs
2. You request a failover via the CLI
3. You remove the primary RPM

Use the command **show redundancy** from EXEC Privilege mode to display the reason for the last failover.

```
FTOS#show redundancy

-- RPM Status --
-----
RPM Slot ID:          0
RPM Redundancy Role:  Primary
RPM State:           Active
RPM SW Version:      7.6.1.0
Link to Peer:        Up

-- PEER RPM Status --
-----
RPM State:           Standby
RPM SW Version:      7.6.1.0

-- RPM Redundancy Configuration --
-----
Primary RPM:         rpm0
Auto Data Sync:     Full
Failover Type:       Hot Failover
Auto reboot RPM:    Enabled
Auto failover limit: 3 times in 60 minutes

-- RPM Failover Record --
-----
Failover Count:      0
Last failover timestamp: None
Last failover Reason: None
Last failover type:  None

-- Last Data Block Sync Record: --
-----
Line Card Config:    succeeded May 19 2008 11:34:06
Start-up Config:     succeeded May 19 2008 11:34:06
Runtime Event Log:   succeeded May 19 2008 11:34:06
Running Config:      succeeded May 19 2008 11:34:07
FTOS#
```

Communication between RPMs

E-Series RPMs have three CPUs: Control Processor (CP), Routing Processor 1 (RP1), and Routing Processor 2 (RP2). The CPUs use Fast Ethernet connections to communicate to each other and to the line card CPUs (LP) using Inter-Processor Communication (IPC). The CP monitors the health status of the other processors by sending a heartbeat message. If any CPU fails to acknowledge a consecutive number of heartbeat messages, or the CP itself fails to send heartbeat messages (IPC timeout), the primary RPM requests a failover to the standby RPM, and FTOS displays a message similar to [Message 4](#).

C-Series RPMs have one CPU: Control Processor (CP). The CP on the RPM communicates with the LP via IPC. Like the E-Series, the CP monitors the health status of the other processors by sending a heartbeat message. If any CPU fails to acknowledge a consecutive number of heartbeat messages, or the CP itself fails to send heartbeat messages (IPC timeout), the primary RPM requests a failover to the standby RPM, and FTOS displays a message similar to [Message 4](#).

Message 4 RPM Failover due to IPC Timeout

```
%RPM1-P:CP %IPC-2-STATUS: target rp2 not responding
%RPM0-S:CP %RAM-6-FAILOVER_REQ: RPM failover request from active peer: Auto failover
on failure
%RPM0-S:CP %RAM-6-ELECTION_ROLE: RPM0 is transitioning to Primary RPM.
%RPM0-P:CP %TSM-6-SFM_SWITCHFAB_STATE: Switch Fabric: UP
```

In addition to IPC, the CP on the each RPM sends heartbeat messages to the CP on its peer RPM via a process called Inter-RPM Communication (IRC). If the primary RPM fails to acknowledge a consecutive number of heartbeat messages (IRC timeout), the standby RPM responds by assuming the role of primary RPM, and FTOS displays message similar to message [Message 5](#).

Message 5 RPM Failover due to IRC Timeout

```
20:29:07: %RPM1-S:CP %IRC-4-IRC_WARNLINKDN: Keepalive packet 7 to peer RPM is lost
20:29:07: %RPM1-S:CP %IRC-4-IRC_COMMDOWN: Link to peer RPM is down
%RPM1-S:CP %RAM-4-MISSING_HB: Heartbeat lost with peer RPM. Auto failover on heart beat lost.
%RPM1-S:CP %RAM-6-ELECTION_ROLE: RPM1 is transitioning to Primary RPM.
```

IPC and IRC timeouts and failover behavior

IPC or IRC timeouts can occur because heartbeat messages and acknowledgements are lost or arrive out of sequence, or a software or hardware failure occurs that impacts IPC or IRC. [Table 20-2, "Failover Behaviors," in High Availability](#) describes the failover behavior for the possible failure scenarios.

Table 20-2. Failover Behaviors

| Platform | Failover Trigger | Failover Behavior |
|----------|---|---|
| C e | CP task crash on the primary RPM | The standby RPM detects the IRC time out and initiates failover, and the failed RPM reboots itself after saving a CP application core dump. |
| C e | CP IRC timeout for a non-task crash reason on the primary RPM | The standby RPM detects IRC time out and initiates failover. FTOS saves a CP trace log, the CP IPC-related system status, and a CP application core dump. Then the failed RPM reboots itself. |
| e | RP task or kernel crash on the primary RPM | CP on the primary RPM detects the RP IPC timeout and notifies the standby RPM. The standby RPM initiates a failover. FTOS saves an RP application or kernel core dump, the CP trace log, and the CP IPC-related system status. Then the new primary RPM reboots the failed RPM. |

Table 20-2. Failover Behaviors

| Platform | Failover Trigger | Failover Behavior |
|----------|---|--|
| e | RP IPC timeout for a non-task crash reason on the primary RPM | CP on primary RPM detects the RP IPC timeout and notifies standby RPM. Standby RPM initiates a failover. FTOS saves an RP application core dump, RP IPC-related system status, a CP trace log record, and the CP IPC-related system status. Then the new primary RPM reboots the failed RPM. |
| C e | Hardware error detected on the primary RPM | FTOS detects the hardware error on the primary RPM and notifies the standby RPM. The standby RPM initiates a failover. FTOS saves a CP trace log, and a CP hardware nvtrace log. Then the new primary RPM reboots the failed RPM. |
| C e | Forced failover via the CLI | CP on primary RPM notifies standby RPM and the standby RPM initiates a failover. FTOS collects no system information. The former primary RPM immediately reboots after failover. |
| C e | Primary RPM is removed | The standby RPM detects the removal and initiates a failover. FTOS collects no system information. |

After a failover, the new primary RPM prompts you for a username and password if authentication methods was configured and that data was synchronized. The standby RPM does not use authentication methods involving client/server protocols, such as RADIUS and TACACS+.

FTOS logs information about IPC timeouts in a log file that you can access. Refer to:

- [C-Series Debugging and Diagnostics, C-Series Debugging and Diagnostics](#)
- [E-Series TeraScale Debugging and Diagnostics, Inter-CPU timeouts](#)

Support for RPM redundancy by FTOS version

FTOS supports increasing levels of RPM redundancy (warm and hot) as described in [Table 20-3, "Support for RPM Redundancy by FTOS Version," in High Availability](#).

Table 20-3. Support for RPM Redundancy by FTOS Version

| Failover Type | Failover Behavior | Platform |
|---------------|--|----------|
| Warm Failover | The new primary RPM remains online, while the failed RPM, all line cards, and all SFMs reboot. | C e |
| Hot Failover | Only the failed RPM reboots. All line cards and SFMs remain online. All application tasks are spawned on the secondary RPM before failover. The running configuration is synchronized at runtime so it does not need to be reapplied during failover. | C e S |

RPM synchronization

Data between the two RPMs is synchronized immediately after bootup. Once the two RPMs have done an initial full synchronization (block sync), thereafter FTOS only updates changed data (incremental sync). The data that is synchronized consists of configuration data, operational data, state and status, and statistics depending on the FTOS version.

| Failover Type | Synchronized Data | Platform |
|---------------|--|----------|
| Warm Failover | some NVRAM information, startup-configuration, line card configurations, user-access configurations | e c s |
| Hot Failover | some NVRAM information, startup-config, line card configurations, user-access configurations, running-config, SFM and datapath states, run-time event log and configuration, interface state | e c s |

RPM redundancy configuration tasks

Select a Primary RPM

The RPM in slot 0 is the primary RPM by default. Manually select the primary RPM using the command **redundancy primary** from CONFIGURATION mode. View which RPM is the primary using the command **show running-config redundancy** from EXEC Privilege mode, as shown in the example in the “Force an RPM failover” section.

```
FTOS#show running-config redundancy
!
redundancy auto-failover-limit count 3 period 60
redundancy auto-synchronize full
redundancy primary rpm0
FTOS#
```

Force an RPM failover

Trigger an RPM failover between RPMs using the command **redundancy force-failover rpm** from EXEC Privilege mode. Use this feature when:

- You are replacing an RPM, and
- You are performing a warm upgrade

```
FTOS#redundancy force-failover rpm
Peer RPM's SW version is different but HA compatible.
Failover can be done by warm or hitless upgrade.
All linecards will be reset during warm upgrade.

Specify hitless upgrade or warm upgrade [confirm hitless/warm]:hitless
Proceed with warm upgrade [confirm yes/no]:
```

Specify an Auto-failover Limit

When a non-recoverable fatal error is detected, an automatic failover occurs. However, FTOS is configured to auto-failover only three times within any 60 minute period. You may specify a different auto-failover count and period using the command `redundancy auto-failover-limit`.

To re-enable the auto-failover-limit with its default parameters, in CONFIGURATION mode, use the **redundancy auto-failover-limit** command without parameters.

Disable Auto-reboot

Prevent a failed RPM from rebooting after a failover using the command **redundancy disable-auto-reboot** from CONFIGURATION mode.

Manually Synchronize RPMs

Manually synchronize RPMs at any time using the command **redundancy synchronize full** from EXEC Privilege mode.

Switch Fabric Module redundancy

[Switch Fabric Module Redundancy](#) is supported on platform: C

Since the RPM on the C-Series also contains the switch fabric, even though the second RPM comes online as the standby, the switch fabric is active and is automatically available for routing. Change this behavior using the command **redundancy sfm standby** from CONFIGURATION mode. To bring the secondary SFM online, enter **no redundancy sfm standby**. There is sub-second packet-loss anytime an SFM is brought online or taken offline. Use the command **show sfm all** to determine the status of the SFMs on the RPMs.

Online Insertion and Removal

You can add, replace, or remove chassis components while the chassis is operating.

This section contains the following sub-sections:

- [RPM Online Insertion and Removal](#)
- [Linecard Online Insertion and Removal](#)

RPM Online Insertion and Removal

Dell Force10 systems are functional with only one RPM. If a second RPM is inserted, it comes online as the standby RPM, as shown in the example below.

On the C-Series, when a secondary RPM with a logical SFM is inserted or removed, the system must add or remove the backplane links to the switch fabric trunk. Any time such links are changed, traffic is disrupted. Use the command **redundancy sfm standby** to avoid any traffic disruption when the secondary RPM is inserted. When this command is executed, the logical SFM on the standby RPM is immediately taken offline, and the SFM state set as standby. Use the command **show sfm all** to see SFM status information.

```
FTOS#show rpm all
```

```
-- Route Processor Modules --
Slot  Status      NxtBoot  Version
-----
 0   active      online   7-5-1-71
 1   not present
%RPM0-P:CP %POLLGR-2-ALT_RPM_STATE: Alternate RPM is present
%RPM0-P:CP %IRC-6-IRC_COMMUP: Link to peer RPM is up
%RPM1-S:CP %RAM-5-RPM_STATE: RPM1 is in Standby State
```

```
FTOS#show rpm all
```

```
-- Route Processor Modules --
Slot  Status      NxtBoot  Version
-----
 0   active      online   7-5-1-71
 1   standby     online   7-5-1-71
```

Linecard Online Insertion and Removal

FTOS detects the line card type when you insert a line card into a online chassis. FTOS writes the line card type to the running-config and maintains this information as a logical configuration if you remove the card (or the card fails), as shown in the example below.

```
FTOS(conf)#do show linecard all
```

```
-- Line cards --
Slot  Status      NxtBoot  ReqTyp  CurTyp  Version  Ports
-----
 0   not present
[output omitted]
```

```
FTOS(conf)# %RPM0-P:CP %CHMGR-5-CARDDETECTED: Line card 0 present
```

```
FTOS(conf)# do show linecard all
```

```
-- Line cards --
Slot  Status      NxtBoot  ReqTyp  CurTyp  Version  Ports
-----
 0   online      online   E48VB   E48VB   7-5-1-71  48
[output omitted]
```

```
FTOS(conf)#%RPM0-P:CP %CHMGR-2-CARD_DOWN: Line card 0 down - card removed
```

```
FTOS(conf)#do show linecard all
```

```
-- Line cards --
Slot  Status      NxtBoot  ReqTyp  CurTyp  Version  Ports
-----
 0   not present          E48VB
[output omitted]
```

Pre-configure a line card slot

You may also pre-configure an empty line card slot with a logical line card using the command **linecard** from CONFIGURATION mode. After creating the logical line card, you can configure the interfaces on the line card as if it is present, as shown in the example below.

```
FTOS(conf)#do show linecard 0

-- Line card 0 --
Status          : not present

FTOS(conf)#int gig 0/0
^
% Error: No card configured in slot at "^" marker.
FTOS(conf)#linecard 0 E48VB
FTOS(conf)#do show linecard 0

-- Line card 0 --
Status          : not present
Required Type   : E48VB - 48-port GE 10/100/1000Base-T line card with RJ45 interfaces and PoE (CB)

FTOS(conf)#int gig 0/0
FTOS(conf-if-gi-0/0)#
```

Replace a line card

If you are replacing a line card with a line card of the same type, you may replace the card without any additional configuration.

If you are replacing a line card with a line card of a different type, remove the card and then remove the existing line card configuration using the command **no linecard**. If you do not, FTOS reports a card mismatch ([Message 6](#)) when you insert the new card, and the installed line card has a card mismatch status.

Message 6 Line card Mismatch Error

```
%RPM0-P:CP %CHMGR-3-CARD_MISMATCH: Mismatch: line card 0 is type E48VB - type E48TB required
```

To clear this line card mismatch status and bring the line card online, specify the type of line card you inserted using the command **linecard**, as shown in the example below.

```
%RPM0-P:CP %CHMGR-5-CARDDETECTED: Line card 0 present

%RPM0-P:CP %CHMGR-3-CARD_MISMATCH: Mismatch: line card 0 is type E48VB - type E48TB required

FTOS#show linecard all

-- Line cards --
Slot  Status      NxtBoot   ReqTyp   CurTyp   Version   Ports
-----
  0    type mismatch online    E48TB    E48VB    7-5-1-71   48
[output omitted]

FTOS(conf)#linecard 0 E48VB
Aug 6 14:25:22: %RPM0-P:CP %IFMGR-1-DEL_PORT: Removed port: Gi 0/0-47
FTOS(conf)#Aug 6 14:25:24: %RPM0-P:CP %CHMGR-5-LINECARDUP: Line card 0 is up

FTOS#show linecard all
```



```

-- Line cards --
Slot  Status      NxtBoot   ReqTyp   CurTyp   Version   Ports
-----
  0    online      online    E48VB   E48VB   7-5-1-71  48
[output omitted]

```

Hitless Behavior

Hitless Behavior is supported only on platforms: C ∈ **S4810** **S4820T**

Hitless behavior is supported on the S4810 with FTOS 8.3.12.0 and later, the S4820T with FTOS 8.3.19.0 and later, or the E-Series ExaScale ∈ \times with FTOS 8.2.1.0. and later.

Hitless is a protocol-based system behavior that makes an RPM failover on the local system transparent to remote systems. The system synchronizes protocol information on the standby and primary RPMs such that, the event of an RPM failover, there is no need to notify remote systems of a local state change.

Hitless behavior is defined in the context of an RPM failover only and does not include line card, SFM, and power module failures.

- On the E-Series: Failovers triggered by software exception, hardware exception, forced failover via the CLI, and manual removal of the primary RPM are all hitless.
- On the C-Series, S4810, and S4820T: Only failovers via the CLI are hitless. The system is not hitless in any other scenario.

Hitless protocols are compatible with other hitless and graceful restart protocols. For example, if hitless OSPF is configured over hitless LACP LAGs, both features work seamlessly to deliver a hitless OSPF-LACP result. However, if hitless behavior involves multiple protocols, all must be hitless in order to achieve a hitless end result. For example, if OSPF is hitless but BFD is not, OSPF operates hitlessly and BFD flaps upon an RPM failover.

The following protocols are hitless:

- Link Aggregation Control Protocol. Refer to [Configure LACP as Hitless](#).
- Spanning Tree Protocol. Refer to [Configuring Spanning Trees as Hitless](#).
- On the E-Series only, Bi-directional Forwarding Detection (line card ports). Refer to [Bidirectional Forwarding Detection \(BFD\)](#).

Graceful Restart

Graceful Restart is supported on platforms: E C S **54810** **54820T**

Graceful restart (also called non-stop forwarding) is a protocol-based mechanism that preserves the forwarding table of the restarting router and its neighbors for a specified period to minimize the loss of packets. A graceful-restart router does not immediately assume that a neighbor is permanently down and so does not trigger a topology change. On E-Series, when you configure graceful restart, the system drops no packets during an RPM failover for protocol-relevant destinations in the forwarding table, and is therefore called “hitless”. On the C-Series and S-Series, packet loss is non-zero, but trivial, and so is still called hitless.

FTOS supports graceful restart for the following protocols:

- Border Gateway Protocol.
- Open Shortest Path First.
- Protocol Independent Multicast—Sparse Mode.
- Intermediate System to Intermediate System.

Software Resiliency

During normal operations FTOS monitors the health of both hardware and software components in the background to identify potential failures, even before these failures manifest.

Runtime System Health Check

Runtime System Health Check is supported on platform: E

FTOS runs a system health check to detect data transfer errors within the system. FTOS performs the check during normal operation by interspersing test frames among the data frames that carry user and system data. One such check is a data plane loopback test.

There are some differences between the TeraScale and ExaScale line card and RPM testing:

- The TeraScale card test contains a loopback from the RPM to the SFM and a loopback from the line cards to the SFM.
- The ExaScale card test contains a loopback from the RPM to the SFM and a loopback from the line cards to the on-board TSF3.
- For TeraScale, each line card and RPM periodically sends out test frames that loop back through the SFM. The loopback health check determines the overall status of the backplane and can identify a faulty SFM. If three consecutive RPM loopbacks fail, then the software initiates a fault isolation procedure that sequentially disables one SFM at a time and performs the same loopback test.

- For ExaScale, the RPM alone RPM periodically sends out test frames that loop back through the SFM. The loopback health check determines the overall status of the backplane and can identify a faulty SFM. If three consecutive RPM loopbacks fail, then the software initiates a fault isolation procedure that sequentially disables one SFM at a time and performs the same loopback test.

Refer to the [E-Series TeraScale Debugging and Diagnostics](#) and [E-Series ExaScale Debugging and Diagnostics](#) chapters for details on the different system checks performed.

SFM Channel Monitoring

PCDFO is supported only on platform: E

Another test that is used to check the integrity of the data plane is a Per-channel De-skew FIFO Overflow (PCDFO). Each ingress and egress Buffer and Traffic Manager (BTM/FPTM) maintains nine channel connections to the SFM. The PCDFO test detects a faulty channel on an SFM, RPM, or line card by creating a test frame and striping it across all nine SFM channels between the eBTM/eFPTM and iBTM/iFPTM. The eBTM/eFPTM must receive each segment of striped data within a specified time to be considered to have proper temporal alignment. Small skews less than the specified time are tolerated because of buffering within the BTM/FPTM. If segments are not received within the specified time, the fault is not tolerated, and FTOS initiates additional tests to isolate the fault.

For more information on the PCDFO test, see [E-Series TeraScale Debugging and Diagnostics, Respond to PCDFO events](#) or [E-Series ExaScale Debugging and Diagnostics](#).



Note: The BTM applies to E-Series TeraScale, and the FPTM applies to the E-Series ExaScale.

Software Component Health Monitoring

On each of the line cards and the RPM, there are a number of software components. FTOS performs a periodic health check on each of these components by querying the status of a flag, which the corresponding component resets within a specified time.

If any health checks on the RPM fail, then the FTOS fails over to standby RPM. If any health checks on a line card fail, FTOS resets the card to bring it back to the correct state.

System Health Monitoring

FTOS also monitors the overall health of the system. Key parameters like CPU utilization, free memory, and error counters (CRC failures, packet loss, etc.) are measured, and upon exceeding a threshold can be used to initiate recovery mechanism.

Failure and Event Logging

Dell Force10 systems provide multiple options for logging failures and events.

Trace Log

Developers interlace messages with software code to track a the execution of a program. These messages are called trace messages; they are primarily used for debugging and provide lower level information than event messages, which are primarily used by system administrators. FTOS retains executed trace messages for hardware and software and stores them in files (logs) on the internal flash.

- NV Trace Log—contains line card bootup trace messages that FTOS never overwrites, and is stored in internal flash under the directory NVTRACE_LOG_DIR.
- Trace Log—contains trace messages related to software and hardware events, state, and errors. Trace Logs are stored in internal flash under the directory TRACE_LOG_DIR.
- Crash Log—contains trace messages related to IPC and IRC timeouts and task crashes on line cards, and is stored under the directory CRASH_LOG_DIR.

For more information on trace logs and configuration options, see:

- [C-Series Debugging and Diagnostics](#)
- [E-Series TeraScale Debugging and Diagnostics](#)
- [E-Series ExaScale Debugging and Diagnostics](#)
- [S-Series Debugging and Diagnostics](#)

Core Dumps

A core dump is the contents of RAM being used by a program at the time of a software exception and is used to identify the cause of the exception. There are two types of core dumps: application and kernel.

- The kernel is the central component of an operating system that manages system processors and memory allocation and makes these facilities available to applications. A kernel core dump is the contents of the memory in use by the kernel at the time of an exception.
- An application core dump is the contents of the memory allocated to a failed application at the time of an exception.

System Log

Event messages provide system administrators diagnostics and auditing information. FTOS sends event messages to the internal buffer, all terminal lines, the console, and optionally to a syslog server. For more information on event messages and configurable options, see [Management](#).

Hot-lock Behavior

FTOS Hot-lock features allow you to append and delete their corresponding CAM entries dynamically without disrupting traffic. Existing entries are simply are shuffled to accommodate new entries.

FTOS offers the following Hot-lock features:

- **Hot-lock IP ACLs** (supported on E-Series, C-Series, and S-Series) allow you to append rules to and delete rules from an Access Control List that is already written to CAM. This behavior is enabled by default and is available for both standard and extended ACLs on ingress and egress. For information on configuring ACLs, see [Access Control Lists \(ACLs\)](#).
- **Hot-lock PBR** (supported on E-Series only) allows you to append rules to and delete rules from a redirect list that is already written to CAM without disrupting traffic. This behavior is enabled by default. For information on configuring Policy-based Routing, see [Policy-based Routing](#).

Warm Upgrade

[Warm Upgrade](#) is supported on platform E

Warm software upgrades use warm failover, which means that FTOS reboots the secondary RPM and all line cards and SFMs. The chassis remains online during the upgrade, but forwarding is interrupted, as shown in [Table 20-4, "Control Plane and Data Plane Status during Warm Upgrade," in High Availability](#).

FTOS supports warm software upgrades under two conditions:

- between consecutive feature releases where only the second digit differs between the running FTOS version number and the upgrade version number. For example, an upgrade from FTOS version 7.6.1.0 to 7.7.1.0 is warm.
- between two consecutive maintenance releases of the same feature release. For example, upgrading from 7.7.1.0 to 7.7.1.1 is warm.

[Table 20-4, "Control Plane and Data Plane Status during Warm Upgrade," in High Availability](#) show the warm upgrade and downtime impact, if any, which each step.

Table 20-4. Control Plane and Data Plane Status during Warm Upgrade

| | Download 6.3.1.1 to RPMs | Reboot RPM1 to Upgrade | Initiate Warm Failover | Reboot RPM0 to Upgrade |
|------------------|---------------------------------|-------------------------------|-------------------------------|-------------------------------|
| RPM 0 | 7.6.1.0 Primary | 7.6.1.0 Primary | 7.6.1.0 Secondary | 7.7.1.0 Secondary |
| RPM 1 | 7.6.1.0 Secondary | 7.7.1.0 Secondary | 7.7.1.0 Primary | 7.7.1.0 Primary |
| Line Cards | 7.6.1.0 | 7.6.1.0 | 7.7.1.0 | 7.7.1.0 |
| Control Plane | Operational | Operational | Interruption | Operational |
| Forwarding State | Forwarding | Forwarding | Interruption | Forwarding |

Configure Cache Boot

Cache Boot is supported on platforms: C e

Cache Boot is supported on E-Series ExaScale e x with FTOS 8.2.1.0. and later.

FTOS Behavior: On E-Series ExaScale, the SFM auto upgrade feature is not supported with cacheboot. If you attempt an SFM auto upgrade, you must reload the chassis to recover.

The Dell Force10 system has the ability to boot the chassis using a cached FTOS image. FTOS stores the system image on the bootflash for each processor so that:

- the processors do not have to download the images during bootup, and
- the processors can boot in parallel rather than serially.

Booting the system by this method significantly reduces the time to bring the system online. Using Cache Boot with Warm Upgrade significantly reduces downtime during an upgrade to bring the system online during routine reloads.

Cache Boot can be configured during runtime. Dell Force10 recommends, however, that it be configured it when the system is offline.

The bootflash is partitioned so that two separate images can be cached, one for each RPM.

Cache Boot Pre-requisites

The system must meet two requirements before you can use the cache boot feature:

1. On the E-Series, the cache boot feature requires RPM hardware revision 2.1 or later. Use the **show rpm** command (shown below) to determine the version of your RPM. There is no hardware requirement for C-Series. In the example below, the relevant information appears in red.

```
FTOS#show rpm

-- RPM card 0 --
Status       : active
Next Boot    : online
Card Type    : RPM - Route Processor Module (LC-EF3-RPM)
Hardware Rev : 2.2i
Num Ports    : 1
Up Time      : 1 day, 4 hr, 25 min
Last Restart : reset by user
FTOS Version : 4.7.5.427
Jumbo Capable : yes
CP Boot Flash : A: 2.4.1.1 [booted] B: 2.4.1.1
RP1 Boot Flash: A: 2.4.1.1 B: 2.4.1.1 [booted]
RP2 Boot Flash: A: 2.4.1.1 B: 2.4.1.1 [booted]
CP Mem Size   : 536870912 bytes
RP1 Mem Size  : 1073741824 bytes
RP2 Mem Size  : 1073741824 bytes
MMC Mem Size  : 520962048 bytes
External MMC  : n/a
Temperature   : 32C
```

```
Power Status : AC
Voltage      : ok
Serial Number : FX000017082
--More--
```

- The cache boot feature requires *at least* the boot code versions in [Table 20-5, "Boot Code Requirements for Cache Boot," in High Availability](#). Use `show rpm` and `show linecard` commands to verify that you have the proper version.

Table 20-5. Boot Code Requirements for Cache Boot

| Component | Boot Code |
|------------------------------|-----------|
| E-Series TeraScale RPM | 2.4.2.1 |
| E-Series TeraScale Line Card | 2.3.2.1 |
| E-Series ExaScale RPM | 2.5.0.3 |
| E-Series ExaScale Line Card | 2.9.0.5 |
| C-Series RPM | 2.7.1.1 |
| C-Series Line Card | 2.6.0.1 |

If you do not have the proper boot code version, the system displays a message similar to [Message 7](#) when you attempt to select a cache boot image (see [Select the Cache Boot Image](#)). See *Upgrading the Boot Code* in the Release Notes for instructions on upgrading boot code.

Message 7 Boot Code Upgrade Required for Cache Boot Error

```
% Error: linecard 0 doesn't have cache boot aware bootCode.
```

Select the Cache Boot Image

Select the FTOS image that you want to cache using the command `upgrade system-image`, as shown in the example below. Dell Force10 recommends using the keyword `all` with this command to avoid any mis-matched configurations.



Note: The cache boot feature is not enabled by default; you must copy the running configuration to the startup configuration (`copy running-config startup-config`) after selecting a cache boot image in order to enable it.

```
FTOS#upgrade system-image all A flash://FTOS-EF-7.8.1.0.bin
```

```
Current cache boot information in the system:
```

```
=====
Type           A           B
-----
CP             invalid      invalid
RP1            invalid[b] [n]  invalid
RP2            invalid      invalid
linecard 0     invalid      invalid
linecard 1 is not present.
linecard 2 is not present.
linecard 3 is not present.
```



```
SECONDARY IMAGE FILE = flash://FTOS-EF-7.7.1.0.bin
DEFAULT IMAGE FILE = flash://FTOS-EF-7.6.1.0.bin
LOCAL CONFIG FILE = variable does not exist
PRIMARY HOST CONFIG FILE = variable does not exist
SECONDARY HOST CONFIG FILE = variable does not exist
PRIMARY NETWORK CONFIG FILE = variable does not exist
SECONDARY NETWORK CONFIG FILE = variable does not exist
CURRENT IMAGE FILE = flash://FTOS-EF-7.7.1.0.bin
CURRENT CONFIG FILE 1 = flash://startup-config
CURRENT CONFIG FILE 2 = variable does not exist
CONFIG LOAD PREFERENCE = local first
BOOT INTERFACE GATEWAY IP ADDRESS = variable does not exist
FTOS#
```

Process Restartability

Process Restartability is an extension to the FTOS high availability system component that enables application processes and system protocol tasks to be restarted. This extension increases system reliability and uptime by attempting to restart the crashed process on primary RPM before executing the failover procedure as a last resort.

Currently, if a software exception occurs, FTOS executes a failover procedure. In a single-RPM system, the system generates a core dump and reboots; in a dual-RPM system, the system generates a core dump and fails over to the standby RPM.

With a system reload, the system must read and apply the entire startup-config file, which might take some time if the startup-config is large. Restarting a process saves time because only a portion of the configuration related to the crashed process is read and re-applied.

For a dual-RPMs system, restarting a process also precludes launching the failover process on the primary and standby RPMs. Recovery is attempted first locally on the primary RPM, which involves less CPU overhead, increasing the systems availability for other activities.

However, in both single and dual-RPM systems, even when Process Restart is configured, the core dump portion of failover is still executed.

The processes that can be restarted fall under three categories:

- **Interface-related processes**—TACACS+, RADIUS, CLI, and SSH, etc.
- **Protocol tasks**—OSPF, RIP, and ACL, etc. Process Restart is not currently available for protocol tasks; the failover procedure is executed immediately upon software exception.
- **Line card processes**—IPC, Event Log Agent, Line Card Manager, etc. Process Restart is not currently available for line card processes; the failover procedure is executed immediately upon software exception.

The restart time varies by process. In general, interface-related processes are hitless and can be restarted in seconds; if a restart is successful, traffic is not interrupted. Protocol tasks and line card processes are not hitless and take longer to restart. You can select which process may attempt to restart and the number of consecutive restart attempts before failover, but by default, every process fails over.

| Task | Command Syntax | Command Mode |
|---|--|----------------|
| Enable Process Restartability for a process or task. | process restartable [<i>process</i>] [<i>try number</i>] [<i>timestamp hours</i>] | CONFIGURATION |
| Display the processes and tasks configured for restart. | show process restartable | EXEC Privilege |

When a process restarts, FTOS displays [Message 9](#).

Message 9 System Message for Process Restarts

```
[9/18 23:22:21] TME-(tme): Starting to restart the failed process tacplus
[9/18 23:22:41] TME-(tme): Finishing restarting the failed process tacplus
```

Customers can specify the timestamp in hour(s) so that if the number of attempts to restart exceeds the max allowed within this timestamp, the restart mode will be changed into failover mode from this moment on. Meaning the next time the crashed process will NOT be restarted but failover to the standby RPM if it is on a dual RPM environment and rebooted if it is on a single RPM.

Internet Group Management Protocol (IGMP)

Internet Group Management Protocol (IGMP) is supported on platforms: **E C S S4810 S4820T**

Multicast is premised on identifying many hosts by a single destination IP address; hosts represented by the same IP address are a *multicast group*. Internet Group Management Protocol (IGMP) is a Layer 3 multicast protocol that hosts use to join or leave a multicast group. Multicast routing protocols (such as PIM) use the information in IGMP messages to discover which groups are active and to populate the multicast routing table.

IGMP Implementation Information

- FTOS supports IGMP versions 1, 2, and 3 based on RFCs 1112, 2236, and 3376, respectively.
- FTOS does not support IGMP version 3 and versions 1 or 2 on the same subnet.
- IGMP on FTOS supports up to 512 interfaces on E-Series, 31 interfaces on C-Series and S25/S50, 95 interfaces on the S4810, S4820T, S55, and S60 and an unlimited number of groups on all platforms.
- Dell Force10 systems cannot serve as an IGMP host or an IGMP version 1 IGMP Querier.
- FTOS automatically enables IGMP on interfaces on which you enable a multicast routing protocol.

IGMP Protocol Overview

IGMP has three versions. Version 3 obsoletes and is backwards-compatible with version 2; version 2 obsoletes version 1.

IGMP version 2

IGMP version 2 improves upon version 1 by specifying IGMP Leave messages, which allows hosts to notify routers that they no longer care about traffic for a particular group. Leave messages reduce the amount of time that the router takes to stop forwarding traffic for a group to a subnet (leave latency) after the last host leaves the group. In version 1 hosts quietly leave groups, and the router waits for a query response timer several times the value of the query interval to expire before it stops forwarding traffic.

To receive multicast traffic from a particular source, a host must join the multicast group to which the source is sending traffic. A host that is a member of a group is called a *receiver*. A host may join many groups, and may join or leave any group at any time. A host joins and leaves a multicast group by sending an IGMP message to its IGMP Querier. The querier is the router that surveys a subnet for multicast receivers, and processes survey responses to populate the multicast routing table.

IGMP messages are encapsulated in IP packets, as shown in the following illustration.

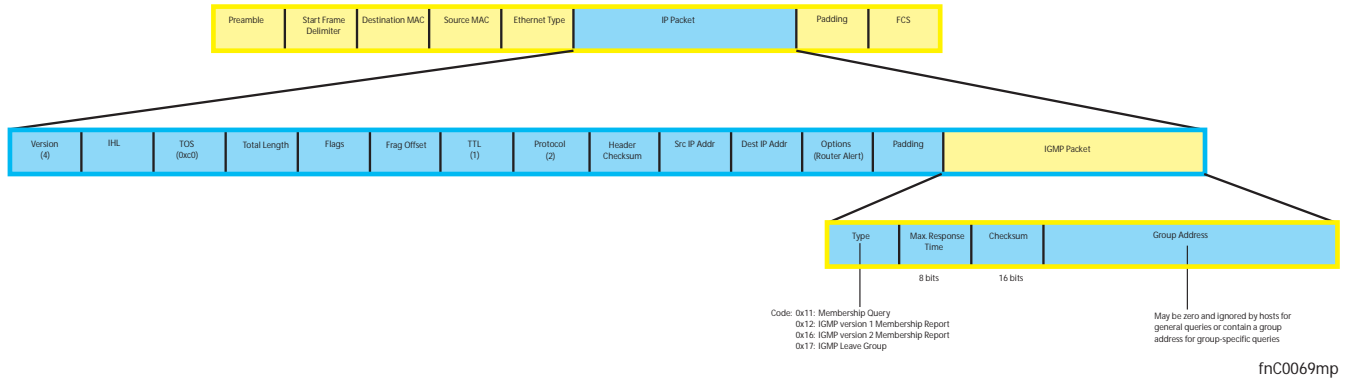

Joining a Multicast Group

There are two ways that a host may join a multicast group: it may respond to a general query from its querier or it may send an unsolicited report to its querier.

Responding to an IGMP Query

1. One router on a subnet is elected as the querier. The querier periodically multicasts (to all-multicast-systems address 224.0.0.1) a general query to all hosts on the subnet.
2. A host that wants to join a multicast group responds with an IGMP Membership Report that contains the multicast address of the group it wants to join (the packet is addressed to the same group). If multiple hosts want to join the same multicast group, only the report from the first host to respond reaches the querier and the remaining hosts suppress their responses (see [Adjusting Query and Response Timers](#) for how the delay timer mechanism works).
3. The querier receives the report for a group and adds the group to the list of multicast groups associated with its outgoing port to the subnet. Multicast traffic for the group is then forwarded to that subnet.

Sending an Unsolicited IGMP Report

A host does not have to wait for a general query to join a group. It may send an unsolicited IGMP Membership Report, also called an IGMP Join message, to the querier.

Leaving a Multicast Group

1. A host sends a membership report of type 0x17 (IGMP Leave message) to the all routers multicast address 224.0.0.2 when it no longer cares about multicast traffic for a particular group.

2. The querier sends a Group-Specific Query to determine whether there are any remaining hosts in the group. There must be at least one receiver in a group on a subnet for a router to forward multicast traffic for that group to the subnet.
3. Any remaining hosts respond to the query according to the delay timer mechanism (see [Adjusting Query and Response Timers](#)). If no hosts respond (because there are none remaining in the group) the querier waits a specified period and sends another query. If it still receives no response, the querier removes the group from the list associated with forwarding port and stops forwarding traffic for that group to the subnet.

IGMP version 3

Conceptually, IGMP version 3 behaves the same as version 2. There are differences:

- Version 3 adds the ability to filter by multicast source, which helps multicast routing protocols avoid forwarding traffic to subnets where there are no interested receivers.
- To enable filtering, routers must keep track of more state information, that is, the list of sources that must be filtered. An additional query type, the Group-and-Source-Specific Query, keeps track of state changes, while the Group-Specific and General queries still refresh the existing state.
- Reporting is more efficient and robust: hosts do not suppress query responses (non-suppression helps track state and enables the immediate-leave and IGMP Snooping features), state-change reports are retransmitted to insure delivery, and a single membership report bundles multiple statements from a single host, rather than sending an individual packet for each statement.

The version 3 packet structure is different from version 2 to accommodate these protocol enhancements. Queries are still sent to the all-systems address 224.0.0.1 as shown in the illustration below, but reports are sent to the all IGMP version 3-capable multicast routers address 244.0.0.22 as shown in the second illustration.

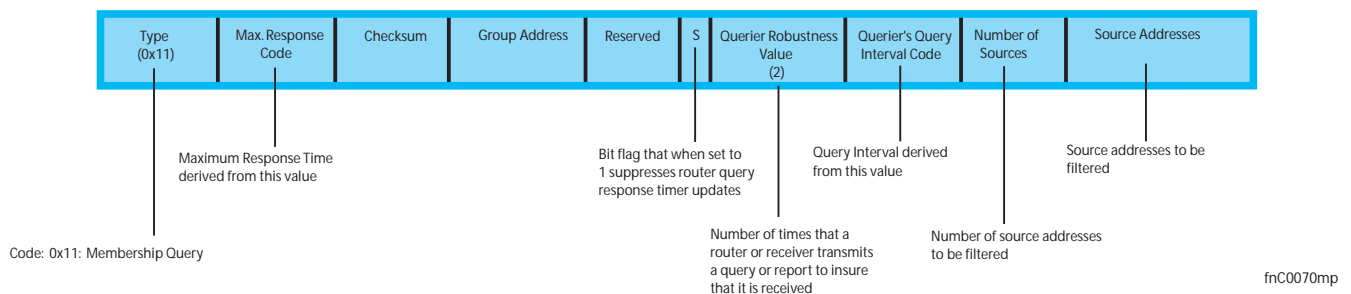

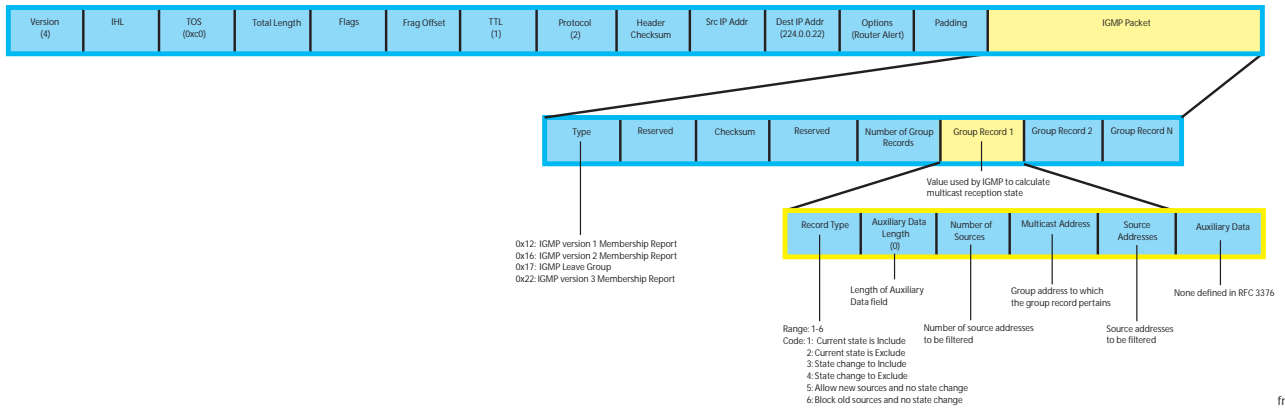

fnC0071mp

Joining and Filtering Groups and Sources

The following illustration shows how multicast routers maintain the group and source information from unsolicited reports.

1. The first unsolicited report from the host indicates that it wants to receive traffic for group 224.1.1.1.
2. The host's second report indicates that it is only interested in traffic from group 224.1.1.1, source 10.11.1.1. Include messages prevent traffic from all other sources in the group from reaching the subnet. Before recording this request, the querier sends a group-and-source query to verify that there are no hosts interested in any other sources. The multicast router must satisfy all hosts if they have conflicting requests. For example, if another host on the subnet is interested in traffic from 10.11.1.3, then the router cannot record the include request. There are no other interested hosts, so the request is recorded. At this point, the multicast routing protocol prunes the tree to all but the specified sources.
3. The host's third message indicates that it is only interested in traffic from sources 10.11.1.1 and 10.11.1.2. Since this request again prevents all other sources from reaching the subnet, the router sends another group-and-source query so that it can satisfy all other hosts. There are no other interested hosts so the request is recorded.

Membership Reports: Joining and Filtering

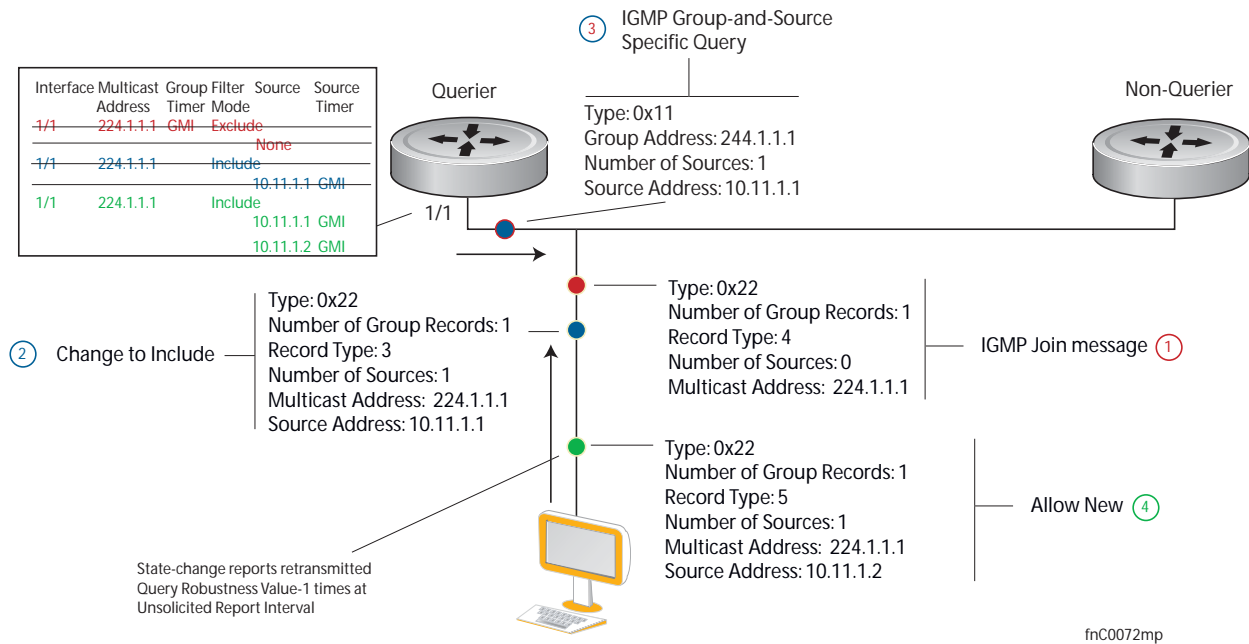

Leaving and Staying in Groups

The illustration below shows how multicast routers track and refresh state changes in response to group-and-specific and general queries.

1. Host 1 sends a message indicating it is leaving group 224.1.1.1 and that the include filter for 10.11.1.1 and 10.11.1.2 are no longer necessary.
2. The querier, before making any state changes, sends a group-and-source query to see if any other host is interested in these two sources; queries for state-changes are retransmitted multiple times. If any are, they respond with their current state information and the querier refreshes the relevant state information.
3. Separately in the following illustration, the querier sends a general query to 224.0.0.1.
4. Host 2 responds to the periodic general query so the querier refreshes the state information for that group.

Membership Queries: Leaving and Staying

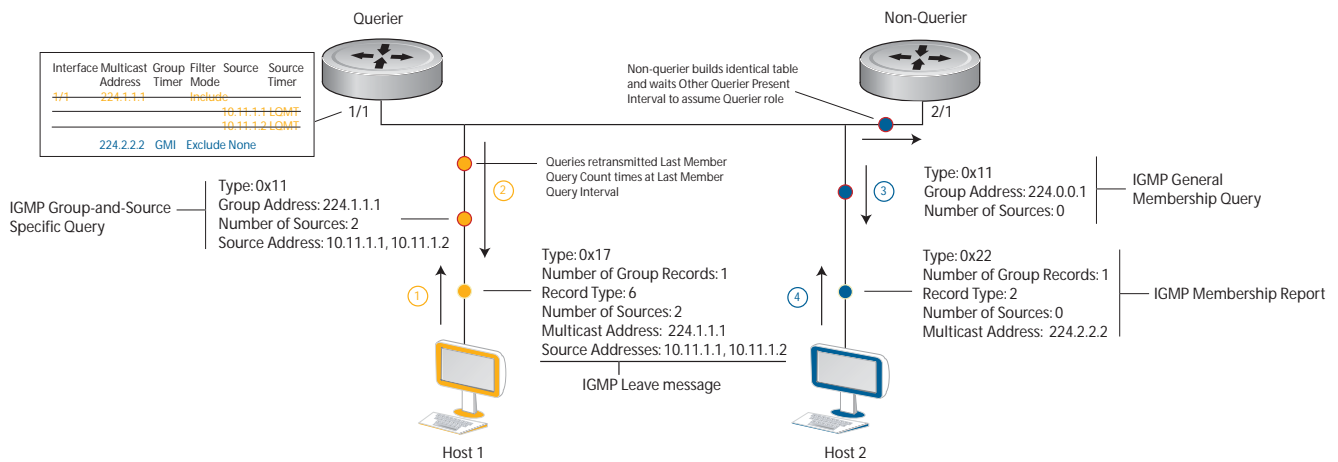

Configuring IGMP

Configuring IGMP is a two-step process:

1. Enable multicast routing using the command **ip multicast-routing**.
2. Enable a multicast routing protocol.

Related Configuration Tasks

- [Viewing IGMP Enabled Interfaces](#)
- [Selecting an IGMP Version](#)
- [Viewing IGMP Groups](#)
- [Adjusting Timers](#)
- [Configuring a Static IGMP Group](#)
- [Prevent a Host from Joining a Group](#)
- [Enabling IGMP Immediate-leave](#)
- [IGMP Snooping](#)
- [Fast Convergence after MSTP Topology Changes](#)
- [Designating a Multicast Router Interface](#)

Viewing IGMP Enabled Interfaces

Interfaces that are enabled with PIM-SM are automatically enabled with IGMP. View IGMP-enabled interfaces using the command **show ip igmp interface** in the EXEC Privilege mode.

```
FTOS#show ip igmp interface gig 7/16
GigabitEthernet 7/16 is up, line protocol is up
  Internet address is 10.87.3.2/24
  IGMP is enabled on interface
  IGMP query interval is 60 seconds
  IGMP querier timeout is 300 seconds
  IGMP max query response time is 10 seconds
  Last member query response interval is 199 ms
  IGMP activity: 0 joins, 0 leaves
  IGMP querying router is 10.87.3.2 (this system)
  IGMP version is 2
FTOS#
```

Selecting an IGMP Version

FTOS enables IGMP version 2 by default, which supports version 1 and 2 hosts, but is not compatible with version 3 on the same subnet. If hosts require IGMP version 3, you can switch to IGMP version 3 using the command **ip igmp version** from INTERFACE mode, as shown in the following example.

```
FTOS(conf-if-gi-1/13)#ip igmp version 3
FTOS(conf-if-gi-1/13)#do show ip igmp interface
GigabitEthernet 1/13 is up, line protocol is down
  Inbound IGMP access group is not set
  Interface IGMP group join rate limit is not set
  Internet address is 1.1.1.1/24
  IGMP is enabled on interface
  IGMP query interval is 60 seconds
  IGMP querier timeout is 125 seconds
  IGMP max query response time is 10 seconds
  IGMP last member query response interval is 1000 ms
  IGMP immediate-leave is disabled
  IGMP activity: 0 joins, 0 leaves, 0 channel joins, 0 channel leaves
  IGMP querying router is 1.1.1.1 (this system)
  IGMP version is 3
FTOS(conf-if-gi-1/13)#
```

Viewing IGMP Groups

View both learned and statically configured IGMP groups using the command **show ip igmp groups** from EXEC Privilege mode.

```
FTOS(conf-if-gi-1/0)#do sho ip igmp groups
Total Number of Groups: 2
IGMP Connected Group Membership
Group Address      Interface          Uptime    Expires    Last Reporter
224.1.1.1          GigabitEthernet 1/0    00:00:03  Never     CLI
224.1.1.2          GigabitEthernet 1/0    00:56:55  00:01:22  1.1.1.2
```

Adjusting Timers

View the current value of all IGMP timers using the command **show ip igmp interface** from EXEC Privilege mode, as shown in the example in [Viewing IGMP Enabled Interfaces](#).

Adjusting Query and Response Timers

The querier periodically sends a general query to discover which multicast groups are active. A group must have at least one host to be active. When a host receives a query, it does not respond immediately, but rather starts a delay timer. The delay time is set to a random value between 0 and the Maximum Response Time. The host sends a response when the timer expires; in version 2, if another host responds before the timer expires, the timer is nullified, and no response is sent.

The Maximum Response Time is the amount of time that the querier waits for a response to a query before taking further action. The querier advertises this value in the query (refer to the illustration in [IGMP version 2](#)). Lowering this value decreases leave latency but increases response burstiness since all host membership reports must be sent before the Maximum Response Time expires. Inversely, increasing this value decreases burstiness at the expense of leave latency.

- Adjust the period between queries using the command **ip igmp query-interval** from INTERFACE mode.
- Adjust the Maximum Response Time using the command **ip igmp query-max-resp-time** from INTERFACE mode.

When the querier receives a leave message from a host, it sends a group-specific query to the subnet. If no response is received, it sends another. The amount of time that the querier waits to receive a response to the initial query before sending a second one is the Last Member Query Interval (LMQI). The switch waits one LMQI after the second query before removing the group from the state table.

- Adjust the Last Member Query Interval using the command **ip igmp last-member-query-interval** from INTERFACE mode.

Adjusting the IGMP Querier Timeout Value

If there is more than one multicast router on a subnet, only one is elected to be the querier, which is the router that sends queries to the subnet.

1. Routers send queries to the all multicast systems address, 224.0.0.1. Initially, all routers send queries.
2. When a router receives a query it compares the IP address of the interface on which it was received with the source IP address given in the query. If the receiving router IP address is greater than the source address given in the query, the router stops sending queries. By this method, the router with the lowest IP address on the subnet is elected querier and continues to send queries.
3. If a specified amount of time elapses during which other routers on the subnet do not receive a query, those routers assume that the querier is down, and a new querier is elected.

The amount of time that elapses before routers on a subnet assume that the querier is down is the Other Querier Present Interval. Adjust this value using the command **ip igmp querier-timeout** from INTERFACE mode.

Configuring a Static IGMP Group

Configure a static IGMP group using the command **ip igmp static-group**. Multicast traffic for static groups is always forwarded to the subnet even if there are no members in the group.

View the static groups using the command **show ip igmp groups** from EXEC Privilege mode. Static groups have an expiration value of *Never* and a Last Reporter value of *CLI*, as shown in the example in [Viewing IGMP Groups](#).

Enabling IGMP Immediate-leave

If the querier does not receive a response to a group-specific or group-and-source query, it sends another (Querier Robustness Value). Then, after no response, it removes the group from the outgoing interface for the subnet.

IGMP Immediate Leave reduces leave latency by enabling a router to immediately delete the group membership on an interface upon receiving a Leave message (it does not send any group-specific or group-and-source queries before deleting the entry). Configure the system for IGMP Immediate Leave using the command **ip igmp immediate-leave**.

View the enable status of this feature using the command **show ip igmp interface** from EXEC Privilege mode, as shown in the example in [Selecting an IGMP Version](#).

IGMP Snooping

Multicast packets are addressed with multicast MAC addresses, which represent a group of devices, rather than one unique device. Switches forward multicast frames out of all ports in a VLAN by default, even though there may be only some interested hosts, which is a waste of bandwidth. IGMP Snooping enables switches to use information in IGMP packets to generate a forwarding table that associates ports with multicast groups so that when they receive multicast frames, they can forward them only to interested receivers.

If IGMP snooping is enabled on a VLT unit, the IGMP snooping dynamically learned groups and multicast router ports are made to learn on the peer by explicitly tunneling the received IGMP control packets.

IGMP Snooping Implementation Information

- IGMP Snooping on FTOS uses IP multicast addresses not MAC addresses.
- IGMP Snooping is supported on all S-Series stack members.
- IGMP Snooping reacts to STP and MSTP topology changes by sending a general query on the interface that transitions to the forwarding state.

Configuring IGMP Snooping

Configuring IGMP Snooping is a one-step process. That is, enable it on a switch using the command **ip igmp snooping enable** from CONFIGURATION mode. View the configuration using the command **show running-config** from CONFIGURATION mode, as shown in the following example. You can disable snooping on for a VLAN using the command **no ip igmp snooping** from INTERFACE VLAN mode.

There is no specific configuration needed for IGMP Snooping in conjunction with VLT. For information on VLT configuration, refer to [Virtual Link Trunking \(VLT\)](#).

```
FTOS(conf)#ip igmp snooping enable
FTOS(conf)#do show running-config igmp
ip igmp snooping enable
FTOS(conf)#
```

Related Configuration Tasks

- [Enabling IGMP Immediate-leave](#)
- [Disabling Multicast Flooding](#)
- [Specifying a Port as Connected to a Multicast Router](#)
- [Configuring the Switch as Querier](#)

Enabling IGMP Immediate-leave

Configure the switch to remove a group-port association upon receiving an IGMP Leave message using the command **ip igmp fast-leave** from INTERFACE VLAN mode. View the configuration using the command **show config** from INTERFACE VLAN mode, as shown in the example below.

```
FTOS(conf-if-vl-100)#show config
!
interface Vlan 100
 no ip address
 ip igmp snooping fast-leave
 shutdown
FTOS(conf-if-vl-100)#
```

Disabling Multicast Flooding

If the switch receives a multicast packet that has an IP address of a group it has not learned (unregistered frame), the switch floods that packet out of all ports on the VLAN.

On the E-Series, you can configure the switch to only forward unregistered packets to ports on a VLAN that are connected to multicast routers (mrouter ports) using the command **no ip igmp snooping flood** from CONFIGURATION mode. When flooding is disabled, if there are no such ports in the VLAN connected to a multicast router, the switch drops the packets.

On the C-Series and S-Series, when you configure **no ip igmp snooping flood**, the system drops the packets immediately. The system does not forward the frames on mrouter ports, even if they are present. On the C-Series and S-Series, Layer 3 multicast must be disabled (**no ip multicast-routing**) in order to disable multicast flooding.

Specifying a Port as Connected to a Multicast Router

You can statically specify a port in a VLAN as connected to a multicast router using the command **ip igmp snooping mrouter** from INTERFACE VLAN mode.

View the ports that are connected to multicast routers using the command **show ip igmp snooping mrouter** from EXEC Privilege mode.

Configuring the Switch as Querier

Hosts that do not support unsolicited reporting wait for a general query before sending a membership report. When the multicast source and receivers are in the same VLAN, multicast traffic is not routed, and so there is no querier. You must configure the switch to be the querier for a VLAN so that hosts send membership reports, and the switch can generate a forwarding table by snooping.

Configure the switch to be the querier for a VLAN by first assigning an IP address to the VLAN interface, and then using the command **ip igmp snooping querier** from INTERFACE VLAN mode.

- IGMP snooping Querier does not start if there is a statically configured multicast router interface in the VLAN.
- The switch may lose the querier election if it does not have the lowest IP address of all potential queriers on the subnet.
- When enabled, IGMP snooping Querier starts after one query interval in case no IGMP general query (with IP SA lower than its VLAN IP address) is received on any of its VLAN members.

Adjusting the Last Member Query Interval

When the querier receives a leave message from a receiver, it sends a group-specific query out of the ports specified in the forwarding table. If no response is received, it sends another. The amount of time that the querier waits to receive a response to the initial query before sending a second one is the Last Member Query Interval (LMQI). The switch waits one LMQI after the second query before removing the group-port entry from the forwarding table.

Adjust the Last Member Query Interval using the command **ip igmp snooping last-member-query-interval** from INTERFACE VLAN mode.

Fast Convergence after MSTP Topology Changes

When a port transitions to the Forwarding state as a result of an STP or MSTP topology change, FTOS sends a general query out of all ports except the multicast router ports. The host sends a response to the general query and the forwarding database is updated without having to wait for the query interval to expire.

When an IGMP snooping switch is not acting as a Querier it sends out the general query, in response to the MSTP triggered link-layer topology change, with the source IP address of 0.0.0.0 to avoid triggering Querier election.

Designating a Multicast Router Interface

You can designate an interface as a multicast router interface with the command **ip igmp snooping mrouter interface**. FTOS also has the capability of listening in on the incoming IGMP General Queries and designate those interfaces as the multicast router interface when the frames have a non-zero IP source address. All IGMP control packets and IP multicast data traffic originating from receivers is forwarded to multicast router interfaces.

Interfaces

This chapter describes interface types, both physical and logical, and how to configure them with FTOS.

10/100/1000 Mbps Ethernet, Gigabit Ethernet, and 10 Gigabit Ethernet interfaces are supported on platforms: `E C S Z` **S4810** **S4820T**

SONET interfaces are only supported on platform `E`.

Basic Interface Configuration:

- [Interface Types](#)
- [View Basic Interface Information](#)
- [Enable a Physical Interface](#)
- [Physical Interfaces](#)
- [Management Interfaces](#)
- [VLAN Interfaces](#)
- [Loopback Interfaces](#)
- [Null Interfaces](#)
- [Port Channel Interfaces](#)

Advanced Interface Configuration:

- [Bulk Configuration](#)
- [Interface Range Macros](#)
- [Monitor and Maintain Interfaces](#)
- [Splitting QSFP ports to SFP+ ports](#)
- [Link Debounce Timer](#)
- [Link Dampening](#)
- [Link Bundle Monitoring](#)
- [Ethernet Pause Frames](#)
- [Configure MTU Size on an Interface](#)
- [Port-pipes](#)
- [Auto-Negotiation on Ethernet Interfaces](#)
- [View Advanced Interface Information](#)

Interface Types

| Interface Type | Modes Possible | Default Mode | Requires Creation | Default State |
|----------------|----------------|--------------|----------------------|--|
| Physical | L2, L3 | Unset | No | Shutdown (disabled) |
| Management | N/A | N/A | No | No Shutdown (enabled) |
| Loopback | L3 | L3 | Yes | No Shutdown (enabled) |
| Null | N/A | N/A | No | Enabled |
| Port Channel | L2, L3 | L3 | Yes | Shutdown (disabled) |
| VLAN | L2, L3 | L2 | Yes (except default) | L2 - No Shutdown (enabled) L3 - Shutdown (disabled) |

View Basic Interface Information

The user has several options for viewing interface status and configuration parameters. The show interfaces command in EXEC mode will list all configurable interfaces on the chassis and has options to display the interface status, IP and MAC addresses, and multiple counters for the amount and type of traffic passing through the interface. If a port channel interface is configured, the show interfaces command can list the interfaces configured in the port channel.



Note: To end output from the system, such as the output from the show interfaces command, enter CTRL+C and FTOS will return to the command prompt.



Note: The CLI output may be incorrectly displayed as 0 (zero) for the Rx/Tx power values. Perform an SNMP query to obtain the correct power information.

The following example displays the configuration and status information for one interface.

```
FTOS#show interfaces tengigabitethernet 1/0
TenGigabitEthernet 1/0 is up, line protocol is up
Hardware is Force10Eth, address is 00:01:e8:05:f3:6a
    Current address is 00:01:e8:05:f3:6a
Pluggable media present, XFP type is 10GBASE-LR.
    Medium is MultiRate, Wavelength is 1310nm
    XFP receive power reading is -3.7685
Interface index is 67436603
Internet address is 65.113.24.238/28
MTU 1554 bytes, IP MTU 1500 bytes
LineSpeed 10000 Mbit, Mode full duplex, Master
ARP type: ARPA, ARP Timeout 04:00:00
Last clearing of "show interface" counters 00:09:54
Queueing strategy: fifo
```



```

Input Statistics:
  0 packets, 0 bytes
  0 Vlans
  0 64-byte pkts, 0 over 64-byte pkts, 0 over 127-byte pkts
  0 over 255-byte pkts, 0 over 511-byte pkts, 0 over 1023-byte pkts
  0 Multicasts, 0 Broadcasts
  0 runts, 0 giants, 0 throttles
  0 CRC, 0 overrun, 0 discarded
Output Statistics:
  3 packets, 192 bytes, 0 underruns
  3 64-byte pkts, 0 over 64-byte pkts, 0 over 127-byte pkts
  0 over 255-byte pkts, 0 over 511-byte pkts, 0 over 1023-byte pkts
  0 Multicasts, 3 Broadcasts, 0 Unicasts
  0 Vlans, 0 throttles, 0 discarded, 0 collisions
Rate info (interval 299 seconds):
  Input 00.00 Mbits/sec,          0 packets/sec, 0.00% of line-rate
  Output 00.00 Mbits/sec,         0 packets/sec, 0.00% of line-rate
Time since last interface status change: 00:00:31
FTOS#

```

Use the `show ip interfaces brief` command in the EXEC Privilege mode to view which interfaces are enabled for Layer 3 data transmission. In the following example, GigabitEthernet interface 1/5 is in Layer 3 mode since an IP address has been assigned to it and the interface's status is operationally up.

```

FTOS#show ip interface brief
Interface          IP-Address      OK? Method Status          Protocol
GigabitEthernet 1/0    unassigned     NO  Manual  administratively down  down
GigabitEthernet 1/1    unassigned     NO  Manual  administratively down  down
GigabitEthernet 1/2    unassigned     YES Manual  up              up
GigabitEthernet 1/3    unassigned     YES Manual  up              up
GigabitEthernet 1/4    unassigned     YES Manual  up              up
GigabitEthernet 1/5    10.10.10.1     YES Manual  up              up
GigabitEthernet 1/6    unassigned     NO  Manual  administratively down  down
GigabitEthernet 1/7    unassigned     NO  Manual  administratively down  down
GigabitEthernet 1/8    unassigned     NO  Manual  administratively down  down

```

Use the `show interfaces configured` command in the EXEC Privilege mode to view only configured interfaces. In the previous example, GigabitEthernet interface 1/5 is in Layer 3 mode since an IP address has been assigned to it and the interface's status is operationally up.

To determine which physical interfaces are available, use the `show running-config` command in EXEC mode. This command displays all physical interfaces available on the line cards.

```

FTOS#show running
Current Configuration ...
!
interface GigabitEthernet 9/6

```

```

no ip address
shutdown
!
interface GigabitEthernet 9/7
no ip address
shutdown
!
interface GigabitEthernet 9/8
no ip address
shutdown
!
interface GigabitEthernet 9/9
no ip address
shutdown

```

Enable a Physical Interface

After determining the type of physical interfaces available, the user may enter the INTERFACE mode by entering the command `interface slot/port` to enable and configure the interfaces.

To enter the INTERFACE mode, use these commands in the following sequence, starting in the CONFIGURATION mode:

| Step | Command Syntax | Command Mode | Purpose |
|------|----------------------------------|---------------|---|
| 1 | <code>interface interface</code> | CONFIGURATION | <p>Enter the keyword <code>interface</code> followed by the type of interface and slot/port information:</p> <ul style="list-style-type: none"> For a 10/100/1000 Ethernet interface, enter the keyword <code>GigabitEthernet</code> followed by the slot/port information. For a Gigabit Ethernet interface, enter the keyword <code>GigabitEthernet</code> followed by the slot/port information. For the Management interface on the RPM, enter the keyword <code>ManagementEthernet</code> followed by the slot/port information. For a SONET interface, enter the keyword <code>sonet</code> followed by slot/port information. For a 10 Gigabit Ethernet interface, enter the keyword <code>TenGigabitEthernet</code> followed by the slot/port information. For a 40-Gigabit Ethernet interface, enter the keyword <code>fortyGigE</code> followed by the slot/port information. |
| 2 | <code>no shutdown</code> | INTERFACE | <p>Enter the <code>no shutdown</code> command to enable the interface. If the interface is a SONET interface, enter the <code>encap ppp</code> command to enable PPP encapsulation.</p> |

To confirm that the interface is enabled, use the `show config` command in the INTERFACE mode. To leave the INTERFACE mode, use the `exit` command or `end` command. The user can not delete a physical interface.

Physical Interfaces

The *Management Ethernet interface* is a single RJ-45 Fast Ethernet port on the Route Processor Module (RPM) of the C-Series and E-Series and on each unit of the S4810 and S4820T. It provides dedicated management access to the system. The other S-Series (non-S4810 or S4820T) systems supported by FTOS do not have this dedicated management interface, but you can use any Ethernet port configured with an IP address and route.

Line card interfaces support Layer 2 and Layer 3 traffic over the 10/100/1000, Gigabit, and 10-Gigabit Ethernet interfaces. SONET interfaces with PPP encapsulation support Layer 3 traffic. These interfaces (except SONET interfaces with PPP encapsulation) can also become part of virtual interfaces such as VLANs or port channels.

Link detection on ExaScale line cards is interrupt-based rather than poll-based, which enables ExaScale cards to bring up and take down links faster.

For more information on VLANs, see [Bulk Configuration](#) and for more information on port channels, see [Port Channel Interfaces](#).

FTOS Behavior: S-Series systems use a single MAC address for all physical interfaces while E-Series and C-Series use a unique MAC address for each physical interface, though this results in no functional difference between these platforms.

Configuration Task List for Physical Interfaces

By default, all interfaces are operationally disabled and traffic will not pass through them.

The following section includes information about optional configurations for physical interfaces:

- [Overview of Layer Modes](#)
- [Configure Layer 2 \(Data Link\) Mode](#)
- [Management Interfaces](#)
- [Auto-Negotiation on Ethernet Interfaces](#)
- [Adjust the keepalive timer](#)
- [Clear interface counters](#)

Overview of Layer Modes

On all systems running FTOS, you can place physical interfaces, port channels, and VLANs in Layer 2 mode or Layer 3 mode.

By default, VLANs are in Layer 2 mode.

Table 22-1. Interfaces Types

| Type of Interface | Possible Modes | Requires Creation | Default State |
|---|--------------------|----------------------------------|---|
| 10/100/1000 Ethernet, Gigabit Ethernet, 10 Gigabit Ethernet | Layer 2 Layer 3 | No | Shutdown (disabled) |
| SONET (PPP encapsulation) | Layer 3 | No | Shutdown (disabled) |
| Management | n/a | No | Shutdown (disabled) |
| Loopback | Layer 3 | Yes | No shutdown (enabled) |
| Null interface | n/a | No | Enabled |
| Port Channel | Layer 2 Layer 3 | Yes | Shutdown (disabled) |
| VLAN | Layer 2 Layer 3 | Yes, except for the default VLAN | No shutdown (active for Layer 2) Shutdown (disabled for Layer 3) |

Configure Layer 2 (Data Link) Mode

Use the switchport command in INTERFACE mode to enable Layer 2 data transmissions through an individual interface. The user can not configure switching or Layer 2 protocols such as spanning tree protocol on an interface unless the interface has been set to Layer 2 mode.

The following example displays the basic configuration found in a Layer 2 interface.

```
FTOS(conf-if)#show config
!
interface Port-channel 1
  no ip address
  switchport
  no shutdown
FTOS(conf-if)#
```

To configure an interface in Layer 2 mode, use these commands in the INTERFACE mode:

| Command Syntax | Command Mode | Purpose |
|----------------|--------------|--|
| no shutdown | INTERFACE | Enable the interface. |
| switchport | INTERFACE | Place the interface in Layer 2 (switching) mode. |

For information on enabling and configuring Spanning Tree Protocol, Refer to [Spanning Tree Protocol \(STP\)](#). To view the interfaces in Layer 2 mode, use the command show interfaces switchport in the EXEC mode.

Configure Layer 3 (Network) Mode

When you assign an IP address to a physical interface, you place it in Layer 3 mode. Use the `ip address` command and no shutdown command in INTERFACE mode to enable Layer 3 mode on an individual interface. In all interface types except VLANs, the shutdown command prevents all traffic from passing through the interface. In VLANs, the shutdown command prevents Layer 3 traffic from passing through the interface. Layer 2 traffic is unaffected by the shutdown command. One of the interfaces in the system must be in Layer 3 mode before you configure or enter a Layer 3 protocol mode (for example, OSPF).

The example below shows how the `show config` command displays an example of a Layer 3 interface.

```
FTOS(conf-if)#show config
!
interface GigabitEthernet 1/5
 ip address 10.10.10.1 /24
 no shutdown
FTOS(conf-if)#
```

If an interface is in the incorrect layer mode for a given command, an error message is displayed to the user. In the example below, the command `ip address` triggered an error message because the interface is in Layer 2 mode and the `ip address` command is a Layer 3 command only.

```
FTOS(conf-if)#show config
!
interface GigabitEthernet 1/2
 no ip address
 switchport
 no shutdown
FTOS(conf-if)#ip address 10.10.1.1 /24
% Error: Port is in Layer 2 mode Gi 1/2.
FTOS(conf-if)#
```

To determine the configuration of an interface, you can use the `show config` command in INTERFACE mode or the various `show interface` commands in EXEC mode.

To assign an IP address, use both of the following commands in the INTERFACE mode:

| Command Syntax | Command Mode | Purpose |
|---|--------------|--|
| <code>no shutdown</code> | INTERFACE | Enable the interface. |
| <code>ip address <i>ip-address mask</i> [<i>secondary</i>]</code> | INTERFACE | Configure a primary IP address and mask on the interface. The <i>ip-address</i> must be in dotted-decimal format (A.B.C.D) and the <i>mask</i> must be in slash format (/xx). Add the keyword <i>secondary</i> if the IP address is the interface's backup IP address. |

You can only configure one (1) primary IP address per interface. You can configure up to 255 secondary IP addresses on a single interface.

To view all interfaces to see with an IP address assigned, use the `show ip interfaces brief` command in the EXEC mode as shown in [View Basic Interface Information](#).

To view IP information on an interface in Layer 3 mode, use the `show ip interface` command in the EXEC Privilege mode as shown in the example below.

```
FTOS>show ip int vlan 58
Vlan 58 is up, line protocol is up
Internet address is 1.1.49.1/24
Broadcast address is 1.1.49.255
Address determined by config file
MTU is 1554 bytes
Inbound access list is not set
Proxy ARP is enabled
Split Horizon is enabled
Poison Reverse is disabled
ICMP redirects are not sent
ICMP unreachable are not sent
```

Management Interfaces

The S4810 and S4820T systems support the Management Ethernet interface as well as the standard S-Series interface on any port. Either method can be used to connect to the system.

Management Interfaces on the E-Series, C-Series, S4810 and the S4820

On the E-Series, C-Series, S4810, and S4820T the dedicated Management interface provides management access to the system. You can configure this interface with FTOS, but the configuration options on this interface are limited. Gateway addresses and IP addresses cannot be configured if it appears in the main routing table of FTOS. In addition, Proxy ARP is not supported on this interface.



Note: On the S4810 and S4820T, a default IP address is assigned to the Management port. Use this IP address to set your laptop Ethernet port to the same network for test purposes.

To configure a Management interface, use the following command in the CONFIGURATION mode:

| Command Syntax | Command Mode | Purpose |
|---|---------------|--|
| interface Managementethernet <i>interface</i> | CONFIGURATION | Enter the slot and the port (0). ON the E-Series and C-Series, dual RPMs can be in use. Slot range: C-Series, E-Series: 0-1 S4810, S4820T: 0 |

To view the Primary RPM Management port, use the show interface Managementethernet command in the EXEC Privilege mode. If there are 2 RPMs, the you cannot view information on that interface.

To configure IP addresses on a Management interface, use the following command in the MANAGEMENT INTERFACE mode:

| Command Syntax | Command Mode | Purpose |
|-----------------------------------|--------------|---|
| ip address <i>ip-address mask</i> | INTERFACE | Configure an IP address and mask on the interface. <ul style="list-style-type: none">• <i>ip-address mask</i>: enter an address in dotted-decimal format (A.B.C.D), the mask must be in /prefix format (/x) |

If there are 2 RPMs on the system, each Management interface must be configured with a different IP address. Unless the management route command is configured, you can only access the Management interface from the local LAN. To access the Management interface from another LAN, the management route command must be configured to point to the Management interface.

Alternatively, you can use virtual-ip to manage a system with one or two RPMs. A virtual IP is an IP address assigned to the system (not to any management interfaces) and is a CONFIGURATION mode command. When a virtual IP address is assigned to the system, the active management interface of the RPM is recognized by the virtual IP address—not by the actual interface IP address assigned to it. During an RPM failover, you do not have to remember the IP address of the new RPM’s management interface—the system will still recognizes the virtual-IP address.

Important Things to Remember — virtual-ip

- **virtual-ip** is a CONFIGURATION mode command.
- When applied, the management port on the primary RPM assumes the virtual IP address. Executing **show interfaces** and **show ip interface brief** commands on the primary RPM management interface will display the virtual IP address and not the actual IP address assigned on that interface.
- A duplicate IP address message is printed for management port’s virtual IP address on an RPM failover. This is a harmless error that is generated due to a brief transitory moment during failover when both RPMs’ management ports own the virtual IP address, but have different MAC addresses.
- The primary management interface will use only the virtual IP address if it is configured. The system can not be accessed through the native IP address of the primary RPM’s management interface.

- Once the virtual IP address is removed, the system is accessible through the native IP address of the primary RPM's management interface.
- Primary and secondary management interface IP and virtual IP must be in the same subnet.

Configure Management Interfaces on the S-Series

The user can manage the S-Series from any port. Configure an IP address for the port using the `ip address` command, and enable it using the command `no shutdown`. The user may use the command `description` from `INTERFACE` mode to note that the interface is the management interface. There is no separate management routing table, so the user must configure all routes in the IP routing table (the `ip route` command).

As shown in the following example, from EXEC Privilege mode, display the configuration for a given port by entering the command `show interface`, and the routing table with the `show ip route` command.

```
FTOS#show int gig 0/48
GigabitEthernet 0/48 is up, line protocol is up
Description: This is the Managment Interface
Hardware is Force10Eth, address is 00:01:e8:cc:cc:ce
  Current address is 00:01:e8:cc:cc:ce
Pluggable media not present
Interface index is 46449666
Internet address is 10.11.131.240/23
[output omitted]
FTOS#show ip route
```

```
Codes: C - connected, S - static, R - RIP,
       B - BGP, IN - internal BGP, EX - external BGP, LO - Locally Originated,
       O - OSPF, IA - OSPF inter area, N1 - OSPF NSSA external type 1,
       N2 - OSPF NSSA external type 2, E1 - OSPF external type 1,
       E2 - OSPF external type 2, i - IS-IS, L1 - IS-IS level-1,
       L2 - IS-IS level-2, IA - IS-IS inter area, * - candidate default,
       > - non-active route, + - summary route
```

```
Gateway of last resort is 10.11.131.254 to network 0.0.0.0
```

| | Destination | Gateway | Dist/Metric | Last Change |
|----|----------------|----------------------------|-------------|-------------|
| | ----- | ----- | ----- | ----- |
| *S | 0.0.0.0/0 | via 10.11.131.254, Gi 0/48 | 1/0 | 1d2h |
| C | 10.11.130.0/23 | Direct, Gi 0/48 | 0/0 | 1d2h |

```
FTOS#
```

VLAN Interfaces

VLANs are logical interfaces and are, by default, in Layer 2 mode. Physical interfaces and port channels can be members of VLANs. For more information on VLANs and Layer 2, refer to [Layer 2](#) and [Virtual LANs \(VLAN\)](#)



Note: To monitor VLAN interfaces, use the Management Information Base for Network Management of TCP/IP-based internets: MIB-II (RFC 1213). Monitoring VLAN interfaces via SNMP is supported only on E-Series.



Note: Egress rate shaping and ingress rate policing cannot be simultaneously used on the same VLAN.

FTOS supports Inter-VLAN routing (Layer 3 routing in VLANs). You can add IP addresses to VLANs and use them in routing protocols in the same manner that physical interfaces are used. For more information on configuring different routing protocols, refer to the chapters on the specific protocol.

A consideration for including VLANs in routing protocols is that the no shutdown command must be configured. (For routing traffic to flow, the VLAN must be enabled.)



Note: An IP address cannot be assigned to the Default VLAN, which, by default, is VLAN 1. To assign another VLAN ID to the Default VLAN, use the default vlan-id *vlan-id* command.

Assign an IP address to an interface with the following command the INTERFACE mode:

| Command Syntax | Command Mode | Purpose |
|--|--------------|---|
| <code>ip address <i>ip-address mask</i> [secondary]</code> | INTERFACE | Configure an IP address and mask on the interface. <ul style="list-style-type: none"><i>ip-address mask</i>: enter an address in dotted-decimal format (A.B.C.D) and the mask must be in slash format (/24).<i>secondary</i>: the IP address is the interface's backup IP address. You can configure up to eight secondary IP addresses. |

The following example shows a sample configuration of a VLAN participating in an OSPF process.

```
interface Vlan 10
 ip address 1.1.1.2/24
 tagged GigabitEthernet 2/2-13
 tagged TenGigabitEthernet 5/0
 ip ospf authentication-key force10
 ip ospf cost 1
 ip ospf dead-interval 60
 ip ospf hello-interval 15
 no shutdown
!
```

Loopback Interfaces

A Loopback interface is a virtual interface in which the software emulates an interface. Packets routed to it are processed locally. Since this interface is not a physical interface, you can configure routing protocols on this interface to provide protocol stability. You can place Loopback interfaces in default Layer 3 mode.

To configure a Loopback interface, use the following command in the CONFIGURATION mode:

| Command Syntax | Command Mode | Purpose |
|----------------------------------|---------------|---|
| interface loopback <i>number</i> | CONFIGURATION | Enter a number as the loopback interface. Range: 0 to 16383. |

To view Loopback interface configurations, use the show interface loopback *number* command in the EXEC mode.

To delete a Loopback interface, use the no interface loopback *number* command syntax in the CONFIGURATION mode.

Many of the same commands found in the physical interface are found in Loopback interfaces.

See also [Configuring ACLs to Loopback](#).

Null Interfaces

The Null interface is another virtual interface created by the E-Series software. There is only one Null interface. It is always up, but no traffic is transmitted through this interface.

To enter the INTERFACE mode of the Null interface, use the following command in the CONFIGURATION mode:

| Command Syntax | Command Mode | Purpose |
|------------------|---------------|---|
| interface null 0 | CONFIGURATION | Enter the INTERFACE mode of the Null interface. |

The only configurable command in the INTERFACE mode of the Null interface is the ip unreachable command.

Port Channel Interfaces

Port channel interfaces support link aggregation, as described in IEEE Standard 802.3ad.

This section covers the following topics:

- [Port channel definition and standards](#)
- [Port channel benefits](#)
- [Port channel implementation](#)
- [Configuration task list for port channel interfaces](#)

Port channel definition and standards

Link aggregation is defined by IEEE 802.3ad as a method of grouping multiple physical interfaces into a single logical interface—a Link Aggregation Group (LAG) or port channel. A LAG is “a group of links that appear to a MAC client as if they were a single link” according to IEEE 802.3ad. In FTOS, a LAG is referred to as a port channel interface.

A port channel provides redundancy by aggregating physical interfaces into one logical interface. If one physical interface goes down in the port channel, another physical interface carries the traffic.

Port channel benefits

For the E-Series, a port channel interface provides many benefits, including easy management, link redundancy, and sharing.

Port channels are transparent to network configurations and can be modified and managed as one interface. For example, you configure one IP address for the group and that IP address is used for all routed traffic on the port channel.

With this feature, the user can create larger-capacity interfaces by utilizing a group of lower-speed links. For example, the user can build a 5-Gigabit interface by aggregating five 1-Gigabit Ethernet interfaces together. If one of the five interfaces fails, traffic is redistributed across the four remaining interfaces.

Port channel implementation

FTOS supports two types of port channels:

- **Static**—Port channels that are statically configured
- **Dynamic**—Port channels that are dynamically configured using Link Aggregation Control Protocol (LACP). For details, see [Link Aggregation Control Protocol \(LACP\)](#).

Table 22-2. Number of Port-channels per Platform

| Platform | Port-channels | Members/Channel |
|----------------------------|---------------|-----------------|
| E-Series TeraScale | 255 | 16 |
| E-Series ExaScale | 512 | 64 |
| C-Series | 128 | 8 |
| S-Series: S25 and S50 | 52 | 8 |
| S55, S60, S4810 and S4820T | 128 | 8 |
| Z9000 | 128 | 8 |

Note: If you are using either 10G ports or 40G ports, the Z9000 supports 8 members per LAG

As soon as a port channel is configured, FTOS treats it like a physical interface. For example, IEEE 802.1Q tagging is maintained while the physical interface is in the port channel.

Member ports of a LAG are added and programmed into hardware in a predictable order based on the port ID, instead of in the order in which the ports come up. With this implementation, load balancing yields predictable results across line card resets and chassis reloads.

A physical interface can belong to only one port channel at a time.

Each port channel must contain interfaces of the same interface type/speed.

Port channels can contain a mix of 10, 100, or 1000 Mbps Ethernet interfaces and Gigabit Ethernet interfaces, and the interface speed (10, 100, or 1000 Mbps) used by the port channel is determined by the first port channel member that is physically up. FTOS disables the interfaces that do not match the interface speed set by the first channel member. That first interface may be the first interface that is physically brought up or was physically operating when interfaces were added to the port channel. For example, if the first operational interface in the port channel is a Gigabit Ethernet interface, all interfaces at 1000 Mbps are kept up, and all 10/100/1000 interfaces that are not set to 1000 speed or auto negotiate are disabled.

FTOS brings up 10/100/1000 interfaces that are set to auto negotiate so that their speed is identical to the speed of the first channel member in the port channel.

10/100/1000 Mbps interfaces in port channels

When both 10/100/1000 interfaces and GigE interfaces are added to a port channel, the interfaces must share a common speed. When interfaces have a configured speed different from the port channel speed, the software disables those interfaces.

The common speed is determined when the port channel is first enabled. At that time, the software checks the first interface listed in the port channel configuration. If that interface is enabled, its speed configuration becomes the common speed of the port channel. If the other interfaces configured in that port channel are configured with a different speed, FTOS disables them.

For example, if four interfaces (Gi 0/0, 0/1, 0/2, 0/3) in which Gi 0/0 and Gi 0/3 are set to speed 100 Mb/s and the others are set to 1000 Mb/s, with all interfaces enabled, and you add them to a port channel by entering `channel-member gigabitethernet 0/0-3` while in the port channel interface mode, and FTOS determines if the first interface specified (Gi 0/0) is up. Once it is up, the common speed of the port channel is 100 Mb/s. FTOS disables those interfaces configured with speed 1000 or whose speed is 1000 Mb/s as a result of auto-negotiation.

In this example, you can change the common speed of the port channel by changing its configuration so the first enabled interface referenced in the configuration is a 1000 Mb/s speed interface. You can also change the common speed of the port channel here by setting the speed of the Gi 0/0 interface to 1000 Mb/s.

Configuration task list for port channel interfaces

To configure a port channel (LAG), you use the commands similar to those found in physical interfaces. By default, no port channels are configured in the startup configuration.

- [Create a port channel](#) (mandatory)
- [Add a physical interface to a port channel](#) (mandatory)
- [Reassign an interface to a new port channel](#) (optional)
- [Configure the minimum oper up links in a port channel \(LAG\)](#) (optional)
- [Add or remove a port channel from a VLAN](#) (optional)
- [Assign an IP address to a port channel](#) (optional)
- [Delete or disable a port channel](#) (optional)
- [Load balancing through port channels](#) (optional)

Create a port channel

You can create up to 255 port channels on an E-Series (255 for TeraScale and ExaScale, 1 to 32 for EtherScale). You can create up to 128 port channels on an C-Series, 52 port channels with 8 port members per group on an S-Series S50 or S25, and 128 port channels with 8 port members per group on an S-Series S55, S60, S4810 and S4820T.

To configure a port channel, use these commands in the following sequence, starting in the CONFIGURATION mode:

| Step | Command Syntax | Command Mode | Purpose |
|------|--|---------------------------|---|
| 1 | <code>interface port-channel <i>id-number</i></code> | CONFIGURATION | Create a port channel. |
| 2 | <code>no shutdown</code> | INTERFACE PORT-CHANNEL | Ensure that the port channel is active. |

The port channel is now enabled and you can place the port channel in Layer 2 or Layer 3 mode. Use the `switchport` command to place the port channel in Layer 2 mode or configure an IP address to place the port channel in Layer 3 mode.

You can configure a port channel as you would a physical interface by enabling or configuring protocols or assigning access control lists.

Add a physical interface to a port channel

The physical interfaces in a port channel can be on any line card in the chassis, but must be the same physical type.



Note: Port channels can contain a mix of Gigabit Ethernet and 10/100/1000 Ethernet interfaces, but FTOS disables the interfaces that are not the same speed of the first channel member in the port channel (see [10/100/1000 Mbps interfaces in port channels](#)).

You can add any physical interface to a port channel if the interface configuration is minimal. Only the following commands can be configured on an interface if it is a member of a port channel:

- description
- shutdown/no shutdown
- mtu
- ip mtu (if the interface is on a Jumbo-enabled by default.)



Note: The S-Series supports jumbo frames by default (the default maximum transmission unit (MTU) is 1554 bytes) You can configure the MTU using the `mtu` command from INTERFACE mode.

To view the interface's configuration, enter the INTERFACE mode for that interface and enter the `show config` command or from the EXEC Privilege mode, enter the `show running-config interface interface` command.

When an interface is added to a port channel, FTOS recalculates the hash algorithm.

To add a physical interface to a port channel, use these commands in the following sequence in the INTERFACE mode of a port channel:

| Step | Command Syntax | Command Mode | Purpose |
|------|--|---------------------------|---|
| 1 | <code>channel-member <i>interface</i></code> | INTERFACE PORT-CHANNEL | Add the interface to a port channel. The <i>interface</i> variable is the physical interface type and slot/port information. |
| 2 | <code>show config</code> | INTERFACE PORT-CHANNEL | Double check that the interface was added to the port channel. |

To view the port channel's status and channel members in a tabular format, use the `show interfaces port-channel brief` command in the EXEC Privilege mode, as shown in the following example.

```
FTOS#show int port brief
```

```
LAG Mode  Status      Uptime    Ports
1   L2L3  up          00:06:03  Gi 13/6   (Up) *
                   Gi 13/12  (Up)
2   L2L3  up          00:06:03  Gi 13/7   (Up) *
                   Gi 13/8   (Up)
                   Gi 13/13  (Up)
                   Gi 13/14  (Up)
```

```
FTOS#
```

The example below displays the port channel's mode (L2 for Layer 2 and L3 for Layer 3 and L2L3 for a Layer 2 port channel assigned to a routed VLAN), the status, and the number of interfaces belonging to the port channel.

```
FTOS>show interface port-channel 20
Port-channel 20 is up, line protocol is up
```

```

Hardware address is 00:01:e8:01:46:fa
Internet address is 1.1.120.1/24
MTU 1554 bytes, IP MTU 1500 bytes
LineSpeed 2000 Mbit
Members in this channel: Gi 9/10 Gi 9/17
ARP type: ARPA, ARP timeout 04:00:00
Last clearing of "show interface" counters 00:00:00
Queueing strategy: fifo
    1212627 packets input, 1539872850 bytes
    Input 1212448 IP Packets, 0 Vlans 0 MPLS
    4857 64-byte pkts, 17570 over 64-byte pkts, 35209 over 127-byte pkts
    69164 over 255-byte pkts, 143346 over 511-byte pkts, 942523 over 1023-byte pkts
    Received 0 input symbol errors, 0 runts, 0 giants, 0 throttles
    42 CRC, 0 IP Checksum, 0 overrun, 0 discarded
    2456590833 packets output, 203958235255 bytes, 0 underruns
    Output 1640 Multicasts, 56612 Broadcasts, 2456532581 Unicasts
    2456590654 IP Packets, 0 Vlans, 0 MPLS
    0 throttles, 0 discarded
Rate info (interval 5 minutes):
    Input 00.01Mbits/sec,          2 packets/sec
    Output 81.60Mbits/sec,      133658 packets/sec
Time since last interface status change: 04:31:57

```

FTOS>

When more than one interface is added to a Layer 2 port channel, FTOS selects one of the active interfaces in the port channel to be the Primary Port. The primary port replies to flooding and sends protocol PDUs. An asterisk in the show interfaces port-channel brief command indicates the primary port.

As soon as a physical interface is added to a port channel, the properties of the port channel determine the properties of the physical interface. The configuration and status of the port channel are also applied to the physical interfaces within the port channel. For example, if the port channel is in Layer 2 mode, you cannot add an IP address or a static MAC address to an interface that is part of that port channel. As the following example illustrates, interface GigabitEthernet 1/6 is part of port channel 5, which is in Layer 2 mode, and an error message appeared when an IP address was configured.

```

FTOS(conf-if-portch)#show config
!
interface Port-channel 5
  no ip address
  switchport
  channel-member GigabitEthernet 1/6
FTOS(conf-if-portch)#int gi 1/6
FTOS(conf-if)#ip address 10.56.4.4 /24
% Error: Port is part of a LAG Gi 1/6.
FTOS(conf-if)#

```

Reassign an interface to a new port channel

An interface can be a member of only one port channel. If the interface is a member of a port channel, you must remove it from the first port channel and then add it to the second port channel.

Each time you add or remove a channel member from a port channel, FTOS recalculates the hash algorithm for the port channel.

To reassign an interface to a new port channel, use these commands in the following sequence in the INTERFACE mode of a port channel:

| Step | Command Syntax | Command Mode | Purpose |
|------|--|---------------------------|---|
| 1 | <code>no channel-member <i>interface</i></code> | INTERFACE PORT-CHANNEL | Remove the interface from the first port channel. |
| 2 | <code>interface port-channel id <i>number</i></code> | INTERFACE PORT-CHANNEL | Change to the second port channel INTERFACE mode. |
| 3 | <code>channel-member <i>interface</i></code> | INTERFACE PORT-CHANNEL | Add the interface to the second port channel. |

The following text displays an example of moving the GigabitEthernet 1/8 interface from port channel 4 to port channel 3.

```
FTOS(conf-if-portch)#show config
!
interface Port-channel 4
  no ip address
  channel-member GigabitEthernet 1/8
  no shutdown
FTOS(conf-if-portch)#no chann gi 1/8
FTOS(conf-if-portch)#int port 5
FTOS(conf-if-portch)#channel gi 1/8
FTOS(conf-if-portch)#sho conf
!
interface Port-channel 5
  no ip address
  channel-member GigabitEthernet 1/8
  shutdown
FTOS(conf-if-portch)#
```

Configure the minimum oper up links in a port channel (LAG)

You can configure the minimum links in a port channel (LAG) that must be in “oper up” status for the port channel to be considered to be in “oper up” status. Use the following command in the INTERFACE mode:

| Command Syntax | Command Mode | Purpose |
|--|--------------|--|
| <code>minimum-links <i>number</i></code> | INTERFACE | Enter the number of links in a LAG that must be in “oper up” status. Default: 1 |

The following text displays an example of configuring five minimum “oper up” links in a port channel.

```
FTOS#config t
FTOS(conf)#int po 1
FTOS(conf-if-po-1)#minimum-links 5
FTOS(conf-if-po-1)#
```

Add or remove a port channel from a VLAN

As with other interfaces, you can add Layer 2 port channel interfaces to VLANs. To add a port channel to a VLAN, you must place the port channel in Layer 2 mode (by using the `switchport` command).

To add a port channel to a VLAN, use either of the following commands:

| Command Syntax | Command Mode | Purpose |
|---|-------------------|--|
| <code>tagged port-channel <i>id number</i></code> | INTERFACE VLAN | Add the port channel to the VLAN as a tagged interface. An interface with tagging enabled can belong to multiple VLANs. |
| <code>untagged port-channel <i>id number</i></code> | INTERFACE VLAN | Add the port channel to the VLAN as an untagged interface. An interface without tagging enabled can belong to only one VLAN. |

To remove a port channel from a VLAN, use either of the following commands:

| Command Syntax | Command Mode | Purpose |
|--|-------------------|--|
| <code>no tagged port-channel <i>id number</i></code> | INTERFACE VLAN | Remove the port channel with tagging enabled from the VLAN. |
| <code>no untagged port-channel <i>id number</i></code> | INTERFACE VLAN | Remove the port channel without tagging enabled from the VLAN. |

To see which port channels are members of VLANs, enter the `show vlan` command in the EXEC Privilege mode.

Assign an IP address to a port channel

You can assign an IP address to a port channel and use port channels in Layer 3 routing protocols.

To assign an IP address, use the following command in the INTERFACE mode:

| Command Syntax | Command Mode | Purpose |
|--|--------------|--|
| <code>ip address <i>ip-address mask</i> [secondary]</code> | INTERFACE | Configure an IP address and mask on the interface. <ul style="list-style-type: none"> <i>ip-address mask</i>: enter an address in dotted-decimal format (A.B.C.D) and the mask must be in slash format (/24). <i>secondary</i>: the IP address is the interface's backup IP address. You can configure up to eight secondary IP addresses. |

Delete or disable a port channel

To delete a port channel, you must be in the CONFIGURATION mode and use the `no interface portchannel channel-number` command.

When you disable a port channel (using the `shutdown` command) all interfaces within the port channel are operationally down also.

Load balancing through port channels

FTOS uses hash algorithms for distributing traffic evenly over channel members in a port channel (LAG). The hash algorithm distributes traffic among ECMP paths and LAG members. The distribution is based on a flow, except for packet-based hashing. A flow is identified by the hash and is assigned to one link. In packet-based hashing, a single flow can be distributed on the LAG and uses one link.

Packet based hashing is used to load balance traffic across a port-channel based on the IP Identifier field within the packet. Load balancing uses source and destination packet information to get the greatest advantage of resources by distributing traffic over multiple paths when transferring data to a destination.

FTOS allows you to modify the hashing algorithms used for flows and for fragments. The `load-balance` and `hash-algorithm` commands are available for modifying the distribution algorithms. Their syntax and implementation are somewhat different between the E-Series and the C-Series and S-Series.



Note: Hash-based load-balancing on MPLS does not work when packet-based hashing (`load-balance ip-selection packet-based`) is enabled.

E-Series load-balancing

On the E-Series, the default load-balance criteria are a 5-tuple, as follows:

- IP source address

- IP destination address
- Protocol type
- TCP/UDP source port
- TCP/UDP destination port

Balancing may be applied to IPv4, switched IPv6, and non-IP traffic. For these traffic types, the IP-header-based hash and MAC-based hash may be applied to packets by using the following methods.

Table 22-3. Hash Methods as Applied to Port Channel Types

| Hash (Header Based) | Layer 2 Port Channel | Layer 3 Port Channel |
|--|----------------------|----------------------|
| 5-tuple | X | X |
| 3-tuple | X | X |
| Packet-based | X | X |
| MAC source address (SA) and destination address (DA) | X | |

On the E-Series, to change the 5-tuple default to 3-tuple, MAC, or packet-based, use the following command in CONFIGURATION mode:

| Command Syntax | Command Mode | Purpose |
|---|---------------|---|
| [no] load-balance [ip-selection {3-tuple packet-based}] [mac] | CONFIGURATION | To designate a method to balance traffic over a port channel. By default, IP 5-tuple is used to distribute traffic over members port channel. ip-selection 3-tuple —Distribute IP traffic based on IP source address, IP destination address, and IP protocol type. ip-selection packet-based —Distribute IPV4 traffic based on the IP Identification field in the IPV4 header. mac —Distribute traffic based on the MAC source address, and the MAC destination address. See Table 22-1 for more information. |

For details on the load-balance command, see the IP Routing chapter of the *FTOS Command Reference*.

To distribute IP traffic over an E-Series port channel member, FTOS uses the 5-tuple IP default. The 5-tuple and the 3-tuple hash use the following keys:

Table 22-4. 5-tuple and 3-tuple Keys

| Keys | 5-tuple | 3-tuple |
|--|---------|---------|
| IP source address (lower 32 bits) | X | X |
| IP destination address (lower 32 bits) | X | X |
| Protocol type | X | X |

Table 22-4. 5-tuple and 3-tuple Keys

| Keys | 5-tuple | 3-tuple |
|--------------------------|---------|---------|
| TCP/UDP source port | X | |
| TCP/UDP destination port | X | |



Note: For IPV6, only the first 32 bits (LSB) of IP Source Address and IP Destination Address are used for hash generation.

The following example shows the configuration and show command for packet-based hashing on the E-Series.

```
FTOS(conf)#load-balance ip-selection packet-based
```

```
FTOS#show running-config | grep load
load-balance ip-selection packet-based
FTOS#
```

The load-balance packet based command can co-exist with load balance mac command to achieve the functionality shown in [Table 22-1](#).

IPv4, IPv6, and non-IP traffic handling on the E-Series

The table below presents the combinations of the load-balance command and their effect on traffic types.

Figure 22-1. The load-balance Commands and Port Channel Types

| Configuration Commands | Switched IP Traffic | Routed IP Traffic (IPv4 only) | Switched Non-IP Traffic |
|---|---|-------------------------------|-------------------------|
| Default (IP 5-tuple) | IP 5-tuple (lower 32 bits) | IP 5-tuple | MAC-based |
| load-balance ip-selection 3-tuple | IP 3-tuple (lower 32 bits) | IP 3-tuple | MAC-based |
| load-balance ip-selection mac | MAC-based | IP 5-tuple | MAC-based |
| load-balance ip-selection 3-tuple load-balance ip-selection mac | MAC-based | IP 3-tuple | MAC-based |
| load-balance ip-selection packet-based | Packet based: IPV4 No distribution: IPV6 | Packet-based | MAC-based |
| load-balance ip-selection packet-based load-balance ip-selection mac | MAC-based | Packet-based | MAC-based |

C-Series and S-Series load-balancing

For LAG hashing on C-Series and S-Series, the source IP, destination IP, source TCP/UDP port, and destination TCP/UDP port are used for hash computation by default. For packets without a Layer 3 header, FTOS automatically uses load-balance mac source-dest-mac.

IP hashing or MAC hashing should not be configured at the same time. If you configure an IP and MAC hashing scheme at the same time, the MAC hashing scheme takes precedence over the IP hashing scheme.

To change the IP traffic load balancing default on the C-Series and S-Series, use the following command:

| Command Syntax | Command Mode | Purpose |
|--|---------------|---|
| [no] load-balance {ip-selection [dest-ip source-ip]} {mac [dest-mac source-dest-mac source-mac]} {tcp-udp enable} {ing-port} | CONFIGURATION | Replace the default IP 4-tuple method of balancing traffic over a port channel. You can select one, two, or all three of the following basic hash methods ip-selection [dest-ip source-ip] —Distribute IP traffic based on IP destination or source address. mac [dest-mac source-dest-mac source-mac] —Distribute IPV4 traffic based on the destination or source MAC address, or both, along with the VLAN, Ethertype, source module ID and source port ID. tcp-udp enable —Distribute traffic based on TCP/UDP source and destination ports. ing-port —Distribute traffic based on the port ID of the IP source address. |

Hash algorithm

The load-balance command discussed above selects the hash criteria applied to port channels.

If even distribution is not obtained with the load-balance command, the hash-algorithm command can be used to select the hash scheme for LAG, ECMP and NH-ECMP. The 12 bit Lag Hash can be rotated or shifted till the desired hash is achieved.

The nh-ecmp option allows you to change the hash value for recursive ECMP routes independently of non-recursive ECMP routes. This option provides for better traffic distribution over available equal cost links that involve a recursive next hop lookup.

For the E-Series TeraScale and ExaScale, you can select one of 47 possible hash algorithms (16 on EtherScale).

| Command Syntax | Command Mode | Purpose |
|---|---------------|---|
| <pre>hash-algorithm { <i>algorithm-number</i> } { <i>ecmp</i> { <i>checksum crc xor</i> } [<i>number</i>] } lag { <i>checksum crc xor</i> } [<i>number</i>] } nh-ecmp p { [<i>checksum crc xor</i>] [<i>number</i>] } { <i>linecard number ip-sa-mask value</i> ip-da-mask <i>value</i> }</pre> | CONFIGURATION | <p>Change the default (0) to another algorithm and apply it to ECMP, LAG hashing, or a particular line card.</p> <p>Note: To achieve the functionality of hash-align on the ExaScale platform, do not use CRC as an hash-algorithm method. For ExaScale systems, set the default hash-algorithm method to ensure CRC is not used for LAG. For example, hash-algorithm <i>ecmp xor lag checksum nh-ecmp checksum</i></p> <p>For details on the algorithm choices, see the command details in the IP Routing chapter of the <i>FTOS Command Reference</i>.</p> |



Note: E-Series systems require the lag-hash-align microcode be configured in the in the CAM profile. E-Series TeraScale E_t includes this microcode as an option with the Default cam profile. E-Series ExaScale E_x systems require that a CAM profile be created and specifically include lag-hash-align microcode.

The following example shows a sample configuration for the hash-algorithm command.

```
FTOS(conf)#hash-algorithm ecmp xor 26 lag crc 26 nh-ecmp checksum 26
FTOS(conf)#
```

On C-Series and S-Series, the hash-algorithm command is specific to ECMP groups and has different defaults from the E-Series. The default ECMP hash configuration is *crc-lower*. This takes the lower 32 bits of the hash key to compute the egress port. Other options for ECMP hash-algorithms are:

- *crc-upper* — uses the upper 32 bits of the hash key to compute the egress port
- *dest-ip* — uses destination IP address as part of the hash key
- *lsb* — always uses the least significant bit of the hash key to compute the egress port

To change to another method, use the following command in the CONFIGURATION mode:

| Command Syntax | Command Mode | Purpose |
|--|---------------|------------------------------|
| <pre>hash-algorithm <i>ecmp</i> { <i>crc-upper</i> } { <i>dest-ip</i> } { <i>lsb</i> }</pre> | CONFIGURATION | Change to another algorithm. |

For more on load-balancing, see “Equal Cost Multipath and Link Aggregation Frequently Asked Questions” in the E-Series FAQ section (login required) of iSupport:

<http://www.force10networks.com/CSPortal20/KnowledgeBase/ToolTips.aspx>

Bulk Configuration

Bulk configuration enables you to determine if interfaces are present for physical interfaces or configured for logical interfaces.

Interface Range

An interface range is a set of interfaces to which other commands may be applied and may be created if there is at least one valid interface within the range. Bulk configuration excludes from configuration any non-existing interfaces from an interface range. A default VLAN may be configured only if the interface range being configured consists of only VLAN ports.

The interface range command allows you to create an interface range allowing other commands to be applied to that range of interfaces.

The interface range prompt offers the interface (with slot and port information) for valid interfaces. The maximum size of an interface range prompt is 32. If the prompt size exceeds this maximum, it displays (...) at the end of the output.



Note: Non-existing interfaces are excluded from interface range prompt. In the following example, Tengigabit 3/0 and VLAN 1000 do not exist.



Note: When creating an interface range, interfaces appear in the order they were entered and are not sorted.

The show range command is available under interface range mode. This command allows you to display all interfaces that have been validated under the interface range context.

The show configuration command is also available under the interface range mode. This command allows you to display the running configuration only for interfaces that are part of interface range.

Bulk Configuration Examples

The following are examples of using the interface range command for bulk configuration:

- [Create a single-range](#)
- [Create a multiple-range](#)
- [Exclude duplicate entries](#)
- [Exclude a smaller port range](#)
- [Overlap port ranges](#)
- [Commas](#)
- [Add ranges](#)

Create a single-range

```
FTOS(config)# interface range gigabitethernet 5/1 - 23
FTOS(config-if-range-gi-5/1-23)# no shutdown
FTOS(config-if-range-gi-5/1-23)#
```

Create a multiple-range

```
FTOS(conf)#interface range tengigabitethernet 3/0 , gigabitethernet 2/1 - 47 , vlan 1000
FTOS(conf-if-range-gi-2/1-47,so-5/0)#
```

Exclude duplicate entries

Duplicate single interfaces and port ranges are excluded from the resulting interface range prompt:

```
FTOS(conf)#interface range vlan 1 , vlan 1 , vlan 3 , vlan 3
FTOS(conf-if-range-vl-1,vl-3)#
FTOS(conf)#interface range gigabitethernet 2/0 - 23 , gigabitethernet 2/0 - 23 , gigab 2/0 - 23
FTOS(conf-if-range-gi-2/0-23)#
```

Exclude a smaller port range

If interface range has multiple port ranges, the smaller port range is excluded from prompt:

```
FTOS(conf)#interface range gigabitethernet 2/0 - 23 , gigab 2/1 - 10
FTOS(conf-if-range-gi-2/0-23)#
```

Overlap port ranges

If overlapping port ranges are specified, the port range is extended to the smallest start port number and largest end port number:

```
FTOS(conf)#inte ra gi 2/1 - 11 , gi 2/1 - 23
FTOS(conf-if-range-gi-2/1-23)#
```

Commas

The example below shows how to use commas to add different interface types to the range, enabling all Gigabit Ethernet interfaces in the range 5/1 to 5/23 and both Ten Gigabit Ethernet interfaces 1/1 and 1/2.

```
FTOS(config-if)# interface range gigabitethernet 5/1 - 23, tengigabitethernet 1/1 - 2
FTOS(config-if-range-gi-5/1-23)# no shutdown
FTOS(config-if-range-gi-5/1-23)#
```

Add ranges

The example below shows how to use commas to add VLAN and port-channel interfaces to the range.

```

FTOS(config-ifrange-gi-5/1-23-te-1/1-2)# interface range Vlan 2 - 100 , Port 1 - 25
FTOS(config-if-range-gi-5/1-23-te-1/1-2-so-5/1-vl-2-100-po-1-25)# no shutdown
FTOS(config-if-range)#

```

Interface Range Macros

The user can define an interface-range macro to automatically select a range of interfaces for configuration. Before you can use the macro keyword in the interface-range macro command string, you must define the macro.

To define an interface-range macro, enter this command:

| Command Syntax | Command Mode | Purpose |
|---|---------------|---|
| <pre> FTOS(config)# define interface-range macro_name {vlan vlan_ID - vlan_ID} {{gigabitethernet tengigabitethernet fortyGigE} slot/interface - interface} [, {vlan vlan_ID - vlan_ID} {{gigabitethernet tengigabitethernet fortyGigE} slot/interface - interface}] </pre> | CONFIGURATION | Defines the interface-range macro and saves it in the running configuration file. |

Define the Interface Range

This example shows how to define an interface-range macro named “test” to select Fast Ethernet interfaces 5/1 through 5/4:

```

FTOS(config)# define interface-range test gigabitethernet 5/1 - 4

```

Choose an Interface-range Macro

To use an interface-range macro in the interface range command, enter this command:

| Command Syntax | Command Mode | Purpose |
|---|---------------|--|
| <pre> interface range macro name </pre> | CONFIGURATION | Selects the interfaces range to be configured using the values saved in a named interface-range macro. |

The example below shows how to change to the interface-range configuration mode using the interface-range macro named “test.”

```

FTOS(config)# interface range macro test
FTOS(config-if)#

```

Monitor and Maintain Interfaces

Monitor interface statistics with the monitor interface command. This command displays an ongoing list of the interface status (up/down), number of packets, traffic statistics, etc.

| Command Syntax | Command Mode | Purpose |
|---|----------------|---|
| monitor interface <i>interface</i> | EXEC Privilege | <p>View the interface's statistics. Enter the type of interface and slot/port information:</p> <ul style="list-style-type: none"> For a 10/100/1000 Ethernet interface, enter the keyword GigabitEthernet followed by the slot/port information. For a Gigabit Ethernet interface, enter the keyword GigabitEthernet followed by the slot/port information. For the Management interface on the RPM, enter the keyword ManagementEthernet followed by the slot/port information. For a SONET interface, enter the keyword sonet followed by slot/port information. For a 10 Gigabit Ethernet interface, enter the keyword TenGigabitEthernet followed by the slot/port information. For a 40-Gigabit Ethernet interface, enter the keyword fortyGigE followed by the slot/port information. |

The information displays in a continuous run, refreshing every 2 seconds by default as shown in the example below. Use the following keys to manage the output.

| | |
|---|---|
| m - Change mode | c - Clear screen |
| l - Page up | a - Page down |
| T - Increase refresh interval (by 1 second) | t - Decrease refresh interval (by 1 second) |
| q - Quit | |

```
FTOS#monitor interface gi 3/1
```

```
FTOS uptime is 1 day(s), 4 hour(s), 31 minute(s)
```

```
Monitor time: 00:00:00 Refresh Intvl.: 2s
```

```
Interface: Gi 3/1, Disabled, Link is Down, Linespeed is 1000 Mbit
```

| Traffic statistics: | Current | Rate | Delta |
|---------------------|---------|-------|-------|
| Input bytes: | 0 | 0 Bps | 0 |
| Output bytes: | 0 | 0 Bps | 0 |
| Input packets: | 0 | 0 pps | 0 |
| Output packets: | 0 | 0 pps | 0 |
| 64B packets: | 0 | 0 pps | 0 |
| Over 64B packets: | 0 | 0 pps | 0 |
| Over 127B packets: | 0 | 0 pps | 0 |

```

Over 255B packets:      0          0 pps          0
Over 511B packets:     0          0 pps          0
Over 1023B packets:    0          0 pps          0
Error statistics:
  Input underruns:     0          0 pps          0
    Input giants:     0          0 pps          0
  Input throttles:    0          0 pps          0
    Input CRC:        0          0 pps          0
Input IP checksum:    0          0 pps          0
  Input overrun:      0          0 pps          0
Output underruns:     0          0 pps          0
Output throttles:     0          0 pps          0

```

```

m - Change mode          c - Clear screen
l - Page up              a - Page down
T - Increase refresh interval
q - Quit                 t - Decrease refresh interval

```

```

q
FTOS#

```

Maintenance using TDR

The Time Domain Reflectometer (TDR) is supported on all Dell Force10 switch/routers. TDR is an assistance tool to resolve link issues that helps detect obvious open or short conditions within any of the four copper pairs. TDR sends a signal onto the physical cable and examines the reflection of the signal that returns. By examining the reflection, TDR is able to indicate whether there is a cable fault (when the cable is broken, becomes unterminated, or if a transceiver is unplugged).

TDR is useful for troubleshooting an interface that is not establishing a link, that is, when the link is flapping or not coming up. TDR is not intended to be used on an interface that is passing traffic. When a TDR test is run on a physical cable, it is important to shut down the port on the far end of the cable. Otherwise, it may lead to incorrect test results.



Note: TDR is an intrusive test. Do not run TDR on a link that is up and passing traffic.

To test the condition of cables on 10/100/1000 BASE-T modules, use the **tdr-cable-test** command:

| Step | Command Syntax | Command Mode | Usage |
|------|--|----------------|--|
| 1 | <code>tdr-cable-test tengigabitethernet <slot>/<port></code> | EXEC Privilege | To test for cable faults on the GigabitEthernet cable. <ul style="list-style-type: none"> Between two ports, the user must not start the test on both ends of the cable. The user must enable the interface before starting the test. The port should be enabled to run the test or the test prints an error message. |
| 2 | <code>show tdr tengigabitethernet <slot>/<port></code> | EXEC Privilege | Displays TDR test results. |

Splitting QSFP ports to SFP+ ports

Splitting QSFP ports to SFP+ ports is supported on platforms: **S4810** **S4820T** Z

The S4810, S4820T and Z9000 platforms support splitting a single 40G QSFP port into four 10G SFP+ ports using one of the supported breakout cables (refer to the *Installation Guide* or the *Release Notes* for a list of supported cables).

| Command Syntax | Command Mode | Purpose |
|--|---------------|---|
| <code>stack-unit stack-unit port number portmode quad</code> | CONFIGURATION | Split a single 40G port into 4-10G ports on the S4810, S4820T, or Z9000. <i>stack-unit</i> : Enter the stack member unit identifier of the stack member to reset. Range: 0 to 11 <i>number</i> : Enter the port number of the 40G port to be split. S4810 and S4820T Range: 0 to 47 for 10G ports; 48, 52, 56 and 60 for 40G ports. Z9000 Range: 0 to 31 |

Important Points

- FANOUT is supported on 40G interfaces in Standalone as well as Stacking environments if the port is not part of a stack link.
- Split ports cannot be used as stack link to stack an S4810, S4820T, or a Z9000.
- If a port is part of a stack link, it cannot support FANOUT configuration.
- The 40G port must be in a default configuration before it can be split into 4x10G ports.
- You will be prompted to save the configuration and reload the system for the change to take effect.

```
FTOS(conf)#stack-unit 0 port 48 portmode quad
```

Enabling quad mode on slot 0 port 48 will make interface configs of Fo 0/48 obsolete after a save and reload.

- [confirm yes/no]:

Link Debounce Timer

Link Debounce Timer is supported on platform E

The Link Debounce Timer feature isolates upper layer protocols on Ethernet switches and routers from very short-term, possibly repetitive interface flaps often caused by network jitter on the DWDM equipment connecting the switch and other devices on a SONET ring. The Link Debounce Timer delays link change notifications, thus decreasing traffic loss due to network configuration. All interfaces have a built-in timer to manage traffic. This feature extends the time allowed by the upper layers.

The SONET ring has its own restore time whenever there is a failure. During this time, however, the Ethernet interface connected to the switch will flap. Link Debounce Timer instructs the Ethernet switch to delay the notification of the link change to the upper layers. If the link state changes again within this period, no notification goes to the upper layers, so that the switch remains unaware of the change.



Note: Enabling the link debounce timer causes link up and link down detections to be delayed, resulting in traffic being blackholed during the debouncing period. This situation might affect the convergence and reconvergence of some Layer 2 and Layer 3 protocols.

Important Points to Remember about Link Debounce Timer

- Link Debounce Timer is configurable on physical ports only.
- Only 1G fiber, 10/100/1000 copper, 10G fiber, 10G copper are supported.
- This feature is not supported on management interfaces or SONET interfaces.
- Link Debounce takes effect only when the operational state of the port is up.
- Link Debounce is supported on interfaces that also have link dampening configured.
- Unlike link dampening, link debounce timer does not notify other protocols.
- Changes made do not affect any ongoing debounces. The timer changes take affect from the next debounce onward.

Assign a debounce time to an interface

| Command Syntax | Command Mode | Purpose |
|--|--------------|---|
| link debounce time [<i>milliseconds</i>] | INTERFACE | Enter the time to delay link status change notification on this interface. Range: 100-5000 ms <ul style="list-style-type: none"> • Default for Copper is 3100 ms • Default for Fiber is 100 ms |

```
FTOS(conf)#int gi 3/1
FTOS(conf-if-gi-3/1)#link debounce time 150
```

```
FTOS (conf-if-gi-3/1) #=
```

Show debounce times in an interface

```
show interface debounce [type] [slot/port] EXEC Privilege
```

Show the debounce time for the specified interface.

Enter the interface type keyword followed by the type of interface and slot/port information:

- For a 10/100/1000 Ethernet interface, enter the keyword `GigabitEthernet` followed by the slot/port information.
- For a Gigabit Ethernet interface, enter the keyword `GigabitEthernet` followed by the slot/port information.
- For a 10 Gigabit Ethernet interface, enter the keyword `TenGigabitEthernet` followed by the slot/port information.

```
FTOS#
FTOS#show interfaces debounce gigabitethernet 3/1
  Interface                Time (ms)
  GigabitEthernet 3/1      200
FTOS#
```



Note: FTOS rounds the entered debounce time up to the nearest hundredth.

Note in the example in [Assign a debounce time to an interface](#) that the timer was set at 150 ms, but appears as 200 in the example in [Show debounce times in an interface](#) above.

Disable ports when one only SFM is available (E300 only)

Selected ports can be shut down when a single SFM is available on the E300 system. Each port to be shut down must be configured individually.

When an E300 system boots up and a single SFM is active this configuration, any ports configured with this feature will be shut down. All other ports are booted up.

Similarly, if an SFM fails (or is removed) in an E300 system with two SFM, ports configured with this feature will be shut down. All other ports are treated normally.

When a second SFM is installed or replaced, all ports are booted up and treated as normally. This feature does not take affect until a single SFM is active in the E300 system.

Disable port on one SFM

This feature must be configured for each interface to shut down in the event that an SFM is disabled. Enter the command `disable-on-sfm-failure` from `INTERFACE` mode to disable the port when only a single SFM is available.

Link Dampening

Interface state changes occur when interfaces are administratively brought up or down or if an interface state changes. Every time an interface changes state or flaps, routing protocols are notified of the status of the routes that are affected by the change in state, and these protocols go through momentous task of re-converging. Flapping therefore puts the status of entire network at risk of transient loops and black holes.

Link dampening minimizes the risk created by flapping by imposing a penalty for each interface flap and decaying the penalty exponentially. Once the penalty exceeds certain threshold, the interface is put in an

“error-disabled” state, and for all practical purposes of routing, the interface is deemed to be “down.” Once the interface becomes stable and the penalty decays below a certain threshold, the interface comes up again and the routing protocols re-converge.

Link dampening:

- reduces processing on the CPUs by reducing excessive interface flapping.
- improves network stability by penalizing misbehaving interfaces and redirecting traffic
- improves convergence times and stability throughout the network by isolating failures so that disturbances are not propagated.

Important Points to Remember

- Link dampening is not supported on VLAN interfaces
- Link dampening is disabled when the interface is configured for port monitoring
- Link dampening can be applied to Layer 2 and Layer 3 interfaces.
- Link dampening can be configured on individual interfaces in a LAG.

Enable Link Dampening

Enable link dampening using the command dampening from INTERFACE mode, as shown in the following example.

```
R1(conf-if-gi-1/1)#show config
!
interface GigabitEthernet 1/1
 ip address 10.10.19.1/24
 dampening 1 2 3 4
 no shutdown
R1(conf-if-gi-1/1)#exit
```

View the link dampening configuration on an interface using the command `show config`, or view dampening information on all or specific dampened interfaces using the command `show interfaces dampening` from EXEC Privilege mode, as shown in the following example.

```
FTOS# show interfaces dampening
InterfaceStateFlapsPenaltyHalf-LifeReuseSuppressMax-Sup
Gi 0/0Up005750250020
Gi 0/1Up21200205001500300
Gi 0/2Down4850306002000120
```

View a dampening summary for the entire system using the command `show interfaces dampening summary` from EXEC Privilege mode, as shown in the example below.

```
FTOS# show interfaces dampening summary
20 interfaces are configured with dampening. 3 interfaces are currently suppressed.
Following interfaces are currently suppressed:
Gi 0/2
Gi 3/1
Gi 4/2
FTOS#
```

Clear Dampening Counters

Clear dampening counters and accumulated penalties using the command `clear dampening`, as shown in the following example.

```
FTOS# clear dampening interface Gi 0/1

FTOS# show interfaces dampening GigabitEthernet0/0
InterfaceStateFlapsPenaltyHalf-LifeReuseSuppressMax-Sup
Gi 0/1Up00205001500300
```

Link Dampening Support for XML

View the output of the following show commands in XML by adding `| display xml` to the end of the command:

- `show interfaces dampening`
- `show interfaces dampening summary`
- `show interfaces interface x/y`

Configure MTU size on an Interface

The E-Series supports a link Maximum Transmission Unit (MTU) of 12000 bytes and maximum IP MTU of 9234 bytes. The link MTU is the frame size of a packet, and the IP MTU size is used for IP fragmentation. If the system determines that the IP packet must be fragmented as it leaves the interface, FTOS divides the packet into fragments no bigger than the size set in the `ip mtu` command.

In FTOS, MTU is defined as the entire Ethernet packet (Ethernet header + FCS + payload)

Since different networking vendors define MTU differently, check their documentation when planing MTU sizes across a network.

Table 22-5 lists the range for each transmission media.

Table 22-5. MTU Range

| Transmission Media | MTU Range (in bytes) |
|--------------------|---|
| Ethernet | 594-12000 = link MTU 576-9234 = IP MTU |

Link Bundle Monitoring

[Link Bundle Monitoring](#) is supported only on platforms: **S4810** **S4820T**

Monitoring linked LAG bundles allows traffic distribution amounts in a link to be monitored for unfair distribution at any given time. A threshold of 60% is defined as an acceptable amount of traffic on a member link. Links are monitored in 15-second intervals for three consecutive instances. Any deviation within that time causes a Syslog to be sent and an alarm event to be generated. When the deviation clears, another Syslog is sent and a clear alarm event is generated.

The link bundle utilization is calculated as the total bandwidth of all links divided by the total bytes-per-second of all links. If monitoring is enabled, the utilization calculation is performed when the utilization of the link-bundle (not a link within a bundle) exceeds 60%.

Enable link bundle monitoring using the `ecmp-group` command.

View all LAG link bundles being monitored using the `show running-config ecmp-group` command.

Ethernet Pause Frames

[Ethernet Pause Frames](#) is supported on platforms **C** **E** **S**

[Threshold Settings](#) are supported only on platforms: **C** **S**

Ethernet Pause Frames allow for a temporary stop in data transmission. A situation may arise where a sending device may transmit data faster than a destination device can accept it. The destination sends a PAUSE frame back to the source, stopping the sender's transmission for a period of time.

The globally assigned 48-bit Multicast address 01-80-C2-00-00-01 is used to send and receive pause frames. To allow full duplex flow control, stations implementing the pause operation instruct the MAC to enable reception of frames with destination address equal to this multicast address.

The PAUSE frame is defined by IEEE 802.3x and uses MAC Control frames to carry the PAUSE commands. Ethernet Pause Frames are supported on full duplex only. The only configuration applicable to half duplex ports is rx off tx off.

Note that if a port is over-subscribed, Ethernet Pause Frame flow control does not ensure no loss behavior.

The following error message appears when trying to enable flow control when half duplex is already configured:

```
Can't configure flowcontrol when half duplex is configure, config ignored.
```

The following error message appears when trying to enable half duplex and flow control configuration is on:

```
Can't configure half duplex when flowcontrol is on, config ignored.
```

Threshold Settings

[Threshold Settings](#) are supported only on platforms: **C S**

When the transmission pause is set (tx on), 3 thresholds can be set to define the controls more closely. Ethernet Pause Frames flow control can be triggered when either the flow control buffer threshold or flow control packet pointer threshold is reached. The thresholds are:

- Number of flow-control packet pointers: 1-2047 (default = 75)
- Flow-control buffer threshold in KB: 1-2013 (default = 49KB)
- Flow-control discard threshold in KB: 1-2013 (default= 75KB)





The pause is started when *either* the packet pointer or the buffer threshold is met (whichever is met first). When the discard threshold is met, packets are dropped.

The pause ends when *both* the packet pointer and the buffer threshold fall below 50% of the threshold settings.

The discard threshold defines when the interface starts dropping the packet on the interface. This may be necessary when a connected device doesn't honor the flow control frame sent by S-Series.

The discard threshold should be larger than the buffer threshold so that the buffer holds at least hold at least 3 packets.

Enable Pause Frames

-  **Note:** On the C-Series and S-Series (non-S4810 or S4820T) platforms, Ethernet Pause Frames TX should be enabled *only after* consulting with the Dell Force10 Technical Assistance Center.
-  **Note:** Changes in the flow-control values may not be reflected automatically in the **show interface** output. As a workaround, apply the new settings, execute **shut** followed by **no shut** on the interface, and then check the running-config of the port.
-  **Note:** The S4810 and S4820T support only the rx control option. The S4810 and S4820T do not transmit pause frames.
-  **Note:** If rx flow control is disabled, Dell Force10 recommends rebooting the system.

Ethernet Pause Frames flow control must be enabled on all ports on a chassis or a line card. If not, the system may exhibit unpredictable behavior.

On the C-Series and S-Series systems, the flow control sender and receiver must be on the same port-pipe. Flow control is not supported across different port-pipes on the C-Series or S-Series system.

| Command Syntax | Command Mode | Purpose |
|---|--------------|---|
| <code>flowcontrol rx [off / on] tx [off / on] [threshold {<1-2047> <1-2013> <1-2013>}]</code> | INTERFACE | Control how the system responds to and generates 802.3x pause frames on 1 and 10Gig line cards. Defaults: C-Series: rx off tx off E-Series: rx on tx on S-Series: rx off tx off S4810 and S4820T: rx off |

| Command Syntax | Command Mode | Purpose |
|----------------|--------------|---|
| | | Parameters: rx on: Enter the keywords rx ON to process the received flow control frames on this port. rx off: Enter the keywords rx Off to ignore the received flow control frames on this port. tx on: Enter the keywords tx ON to send control frames from this port to the connected device when a higher rate of traffic is received. tx off: Enter the keywords tx Off so that flow control frames are not sent from this port to the connected device when a higher rate of traffic is received. threshold (C-Series and S-Series only): When tx on is configured, the user can set the threshold values for: Number of flow-control packet pointers: 1-2047 (default = 75) Flow-control buffer threshold in KB: 1-2013 (default = 49KB) Flow-control discard threshold in KB: 1-2013 (default= 75KB) Pause control is triggered when either the flow control buffer threshold or flow control packet pointer threshold is reached. |

Configure MTU Size on an Interface

If a packet includes a Layer 2 header, the difference in bytes between the link MTU and IP MTU must be enough to include the Layer 2 header. For example, for VLAN packets, if the IP MTU is 1400, the Link MTU must be no less than 1422:

$$1400\text{-byte IP MTU} + 22\text{-byte VLAN Tag} = 1422\text{-byte link MTU}$$

The MTU range is 592-12000, with a default of 1500. On the E-Series, the user must enter the `ip mtu` command to manually configure the IP MTU to compensate for the Layer 2 header. The C-Series and S-Series automatically configure the IP MTU.

Table 22-6 lists the various Layer 2 overheads found in FTOS and the number of bytes.

Table 22-6. Difference between Link MTU and IP MTU

| Layer 2 Overhead | Difference between Link MTU and IP MTU |
|--|--|
| Ethernet (untagged) | 18 bytes |
| VLAN Tag | 22 bytes |
| Untagged Packet with VLAN-Stack Header | 22 bytes |
| Tagged Packet with VLAN-Stack Header | 26 bytes |

Link MTU and IP MTU considerations for port channels and VLANs are as follows.

Port Channels:

- All members must have the same link MTU value and the same IP MTU value.

- The port channel link MTU and IP MTU must be less than or equal to the link MTU and IP MTU values configured on the channel members.

Example: If the members have a link MTU of 2100 and an IP MTU 2000, the port channel's MTU values cannot be higher than 2100 for link MTU or 2000 bytes for IP MTU.

VLANs:

- All members of a VLAN must have the same IP MTU value.
- Members can have different Link MTU values. Tagged members must have a link MTU 4 bytes higher than untagged members to account for the packet tag.
- The VLAN link MTU and IP MTU must be less than or equal to the link MTU and IP MTU values configured on the VLAN members.

Example: The VLAN contains tagged members with Link MTU of 1522 and IP MTU of 1500 and untagged members with Link MTU of 1518 and IP MTU of 1500. The VLAN's Link MTU cannot be higher than 1518 bytes and its IP MTU cannot be higher than 1500 bytes.

Port-pipes

A port pipe is a Dell Force10 specific term for the hardware path that packets follow through a system. Port pipes travel through a collection of circuits (ASICs) built into line cards and RPMs on which various processing events for the packets occur. One or two port pipes process traffic for a given set of physical interfaces or a port-set. The E300 only supports one port pipe per slot. On the E1200 and E600 each slot has two port pipes with following specifications:

- 48 port line rate cards have two port pipes on the line card
- 48 port high density cards have only one port pipe on the line card



Note: All references to the E1200 in this section include the E1200i-AC and E1200i-DC. References to E600 include the E600i.

For the purposes of diagnostics, the major difference between the E-Series platforms is the number of port pipes per slot.

- E1200 and E600—Each slot has two port-pipes. Each portpipe has nine 3.125Gbps channels to the backplane, one to each SFM.
- E300—Each slot has one portpipe. Each port-pipe has eight 3.125Gbps channels to the backplane, with four channels to each SFM.

Table 22-7 presents these platform differences again.

Table 22-7. Platform Differences Concerning Port-pipes

| Chassis Type | Port-pipes / Slot | Channels / Port-pipe | Capacity of Each Channel (Gbps) | Raw Slot Capacity (Gbps) |
|--------------------|-------------------|----------------------|---------------------------------|--------------------------|
| E1200/E1200i-AC/DC | 2 | 9 | 3.125 | 56.25 |
| E600/E600i | 2 | 9 | 3.125 | 56.25 |
| E300 | 1 | 8 | 3.125 | 25 |

Auto-Negotiation on Ethernet Interfaces

Setting speed and duplex mode of Ethernet Interfaces

By default, auto-negotiation of speed and duplex mode is enabled on 10/100/1000 Base-T Ethernet interfaces. Only 10GE interfaces do not support auto-negotiation. When using 10GE interfaces, verify that the settings on the connecting devices are set to no auto-negotiation.



Note: Starting with FTOS 7.8.1.0, when a copper SFP2 module with catalog number GP-SFP2-1T is used in the S25P model of the S-Series, its speed can be manually set with the speed command. When the speed is set to 10 or 100 Mbps, the duplex command can also be executed.

The local interface and the directly connected remote interface must have the same setting, and auto-negotiation is the easiest way to accomplish that, as long as the remote interface is capable of auto-negotiation.

Note: As a best practice, Dell Force10 recommends keeping auto-negotiation enabled. Auto-negotiation should only be disabled on switch ports that attach to devices not capable of supporting negotiation or where connectivity issues arise from interoperability issues.

For 10/100/1000 Ethernet interfaces, the negotiation auto command is tied to the speed command. Auto-negotiation is always enabled when the speed command is set to 1000 or auto. In FTOS, the command **speed 100** is an exact equivalent of **speed auto 100** in IOS.

To discover whether the remote and local interface require manual speed synchronization, and to manually synchronize them if necessary, use the following command sequence as shown in the second example:

| Step | Task | Command Syntax | Command Mode |
|------|---|---|------------------------|
| 1 | Determine the local interface status. Refer to the example below. | show interfaces [<i>interface</i> linecard <i>slot-number</i>] status | EXEC Privilege |
| 2 | Determine the remote interface status. | [Use the command on the remote system that is equivalent to the above command.] | EXEC EXEC Privilege |

| Step | Task | Command Syntax | Command Mode |
|------|--|--------------------------------------|----------------|
| 3 | Access CONFIGURATION mode. | config | EXEC Privilege |
| 4 | Access the port. | interface <i>interface slot/port</i> | CONFIGURATION |
| 5 | Set the local port speed. | speed {10 100 1000 auto} | INTERFACE |
| 6 | Optionally, set full- or half-duplex. | duplex {half full} | INTERFACE |
| 7 | Disable auto-negotiation on the port. If the speed was set to 1000, auto-negotiation does not need to be disabled. | no negotiation auto | INTERFACE |
| 8 | Verify configuration changes. | show config | INTERFACE |



Note: The show interfaces status command displays link status, but not administrative status. For link and administrative status, use show ip interface [interface | brief | linecard slot-number] [configuration].

```
FTOS#show interfaces status
Port      Description Status Speed      Duplex Vlan
Gi 0/0                Up      1000 Mbit  Auto   --
Gi 0/1                Down    Auto      Auto    1
Gi 0/2                Down    Auto      Auto    1
Gi 0/3                Down    Auto      Auto    --
Gi 0/4 Force10Port    Up      1000 Mbit  Auto   30-130
Gi 0/5                Down    Auto      Auto    --
Gi 0/6                Down    Auto      Auto    --
Gi 0/7                Up      1000 Mbit  Auto   1502,1504,1506-1508,1602
Gi 0/8                Down    Auto      Auto    --
Gi 0/9                Down    Auto      Auto    --
Gi 0/10               Down    Auto      Auto    --
Gi 0/11               Down    Auto      Auto    --
Gi 0/12               Down    Auto      Auto    --
[output omitted]
```

In the example above, several ports display “Auto” in the Speed field, including port 0/1. In the following example, the speed of port 0/1 is set to 100Mb and then its auto-negotiation is disabled.

```
FTOS#configure
FTOS(config)#interface gig 0/1
FTOS(Interface 0/1)#speed 100
FTOS(Interface 0/1)#duplex full
FTOS(Interface 0/1)#no negotiation auto
FTOS(Interface 0/1)#show config
!
interface GigabitEthernet 0/1
no ip address
speed 100
```

```
duplex full
no shutdown
```

Setting Auto-Negotiation Options

The negotiation auto command provides a mode option for configuring an individual port to forced master/forced slave once auto-negotiation is enabled.



Caution: Ensure that only one end of the node is configured as forced-master and the other is configured as forced-slave. If both are configured the same (that is both as forced-master or both as forced-slave), the `show interface` command will flap between an auto-neg-error and forced-master/slave states.

```
FTOS(conf)# int gi 0/0
FTOS(conf-if)#neg auto
FTOS(conf-if-autoneg)# ?
```

```
end                Exit from configuration mode
exit               Exit from autoneg configuration mode
mode              Specify autoneg mode
no                Negate a command or set its defaults
show              Show autoneg configuration information
FTOS(conf-if-autoneg) #mode ?
forced-master     Force port to master mode
forced-slave      Force port to slave mode
FTOS(conf-if-autoneg) #
```

For details on the speed, duplex, and negotiation auto commands, see the Interfaces chapter of the *FTOS Command Reference*.

Adjust the keepalive timer

Use the `keepalive` command to change the time interval between keepalive messages on the interfaces. The interface sends keepalive messages to itself to test network connectivity on the interface.

To change the default time interval between keepalive messages, use the following command:

| Command Syntax | Command Mode | Purpose |
|----------------------------------|--------------|---|
| <code>keepalive [seconds]</code> | INTERFACE | Change the default interval between keepalive messages. |

To view the new setting, use the `show config` command in the INTERFACE mode.

View Advanced Interface Information

Dell Force10 platforms provide a number of advanced viewing capabilities that control how interface information is presented. These features are the following:

- [Display Only Configured Interfaces](#)
- [Configure Interface Sampling Size](#)
- [Dynamic Counters](#)
- [Clear interface counters](#)

Display Only Configured Interfaces

The following options have been implemented for show [ip | running-config] interfaces commands for (only) linecard interfaces. When the configured keyword is used, only interfaces that have non-default configurations are displayed. Dummy linecard interfaces (created with the linecard command) are treated like any other physical interface.

The following example lists the possible show commands that have the configured keyword available:

```
FTOS#show interfaces configured
FTOS#show interfaces linecard 0 configured
FTOS#show interfaces gigabitEthernet 0 configured
FTOS#show ip interface configured
FTOS#show ip interface linecard 1 configured
FTOS#show ip interface gigabitEthernet 1 configured
FTOS#show ip interface br configured
FTOS#show ip interface br linecard 1 configured
FTOS#show ip interface br gigabitEthernet 1 configured
FTOS#show running-config interfaces configured
FTOS#show running-config interface gigabitEthernet 1 configured
```

In EXEC mode, the show interfaces switchport command displays only interfaces in Layer 2 mode and their relevant configuration information. The show interfaces switchport command as shown in the example below displays the interface, whether the interface supports IEEE 802.1Q tagging or not, and the VLANs to which the interface belongs.

```
FTOS#show interfaces switchport
Name: GigabitEthernet 13/0
802.1QTagged: True
Vlan membership:
Vlan    2

Name: GigabitEthernet 13/1
802.1QTagged: True
Vlan membership:
```

```

Vlan    2

Name: GigabitEthernet 13/2
802.1QTagged: True
Vlan membership:
Vlan    2

Name: GigabitEthernet 13/3
802.1QTagged: True
Vlan membership:
Vlan    2

```

```
--More--
```

Configure Interface Sampling Size

Use the `rate-interval` command, in `INTERFACE` mode, to configure the number of seconds of traffic statistics to display in the `show interfaces` output.

Although any value between 30 and 299 seconds (the default) can be entered, software polling is done once every 15 seconds. So, for example, if you enter “19”, you will actually get a sample of the past 15 seconds.

All LAG members inherit the rate interval configuration from the LAG.

The following example shows how to configure rate interval when changing the default value:

```

FTOS#show interfaces
TenGigabitEthernet 10/0 is down, line protocol is down
Hardware is Force10Eth, address is 00:01:e8:01:9e:d9
Internet address is not set
MTU 1554 bytes, IP MTU 1500 bytes
LineSpeed 10000 Mbit
ARP type: ARPA, ARP Timeout 04:00:00
Last clearing of "show interface" counters 1d23h44m
Queueing strategy: fifo
    0 packets input, 0 bytes
    Input 0 IP Packets, 0 Vlans 0 MPLS
    0 64-byte pkts, 0 over 64-byte pkts, 0 over 127-byte pkts
    0 over 255-byte pkts, 0 over 511-byte pkts, 0 over 1023-byte pkts
    Received 0 input symbol errors, 0 runts, 0 giants, 0 throttles
    0 CRC, 0 IP Checksum, 0 overrun, 0 discarded
    0 packets output, 0 bytes, 0 underruns

```

```
Output 0 Multicasts, 0 Broadcasts, 0 Unicasts
0 IP Packets, 0 Vlans, 0 MPLS
0 throttles, 0 discarded
Rate info (interval 299 seconds):
Input 00.00 Mbits/sec,          0 packets/sec, 0.00% of line-rate
Output 00.00 Mbits/sec,        0 packets/sec, 0.00% of line-rate
Time since last interface status change: 1d23h40m
```

```
FTOS(conf)#interface tengigabitethernet 10/0
FTOS(conf-if-te-10/0)#rate-interval 100
```

```
FTOS#show interfaces
TenGigabitEthernet 10/0 is down, line protocol is down
Hardware is Force10Eth, address is 00:01:e8:01:9e:d9
Internet address is not set
MTU 1554 bytes, IP MTU 1500 bytes
LineSpeed 10000 Mbit
ARP type: ARPA, ARP Timeout 04:00:00
Last clearing of "show interface" counters 1d23h45m
Queueing strategy: fifo
  0 packets input, 0 bytes
  Input 0 IP Packets, 0 Vlans 0 MPLS
  0 64-byte pkts, 0 over 64-byte pkts, 0 over 127-byte pkts
  0 over 255-byte pkts, 0 over 511-byte pkts, 0 over 1023-byte pkts
  Received 0 input symbol errors, 0 runts, 0 giants, 0 throttles
  0 CRC, 0 IP Checksum, 0 overrun, 0 discarded
  0 packets output, 0 bytes, 0 underruns
  Output 0 Multicasts, 0 Broadcasts, 0 Unicasts
  0 IP Packets, 0 Vlans, 0 MPLS
  0 throttles, 0 discarded
Rate info (interval 100 seconds):
Input 00.00 Mbits/sec,          0 packets/sec, 0.00% of line-rate
Output 00.00 Mbits/sec,        0 packets/sec, 0.00% of line-rate
Time since last interface status change: 1d23h42m
```

Dynamic Counters

By default, counting for the following four applications is enabled:

- IPFLOW
- IPACL
- L2ACL
- L2FIB

For remaining applications, FTOS automatically turns on counting when the application is enabled, and is turned off when the application is disabled. Please note that if more than four counter-dependent applications are enabled on a port pipe, there is an impact on line rate performance.

The following counter-dependent applications are supported by FTOS:

- Egress VLAN
- Ingress VLAN
- Next Hop 2
- Next Hop 1
- Egress ACLs
- ILM
- IP FLOW
- IP ACL
- IP FIB
- L2 ACL
- L2 FIB

Clear interface counters

The counters in the show interfaces command are reset by the clear counters command. This command does not clear the counters captured by any SNMP program.

To clear the counters, use the following command in the EXEC Privilege mode:

| Command Syntax | Command Mode | Purpose |
|--|----------------|---|
| <code>clear counters [interface] [vrrp [vrid] learning-limit]</code> | EXEC Privilege | <p>Clear the counters used in the show interface commands for all VRRP groups, VLANs, and physical interfaces or selected ones. Without an interface specified, the command clears all interface counters.</p> <p>(OPTIONAL) Enter the following interface keywords and slot/port or number information:</p> <ul style="list-style-type: none">• For a 1-Gigabit Ethernet interface, enter the keyword GigabitEthernet followed by the slot/port information.• For a Loopback interface, enter the keyword loopback followed by a number from 0 to 16383.• For a Port Channel interface, enter the keyword port-channel followed by a number from 1 to 255 for TeraScale and ExaScale, 1 to 32 for EtherScale.• For the management interface on the RPM, enter the keyword ManagementEthernet followed by slot/port information. The slot range is 0-1, and the port range is 0.• For a SONET interface, enter the keyword sonet followed by the slot/port information.• For a 10-Gigabit Ethernet interface, enter the keyword TenGigabitEthernet followed by the slot/port information.• For a 40-Gigabit Ethernet interface, enter the keyword fortyGigE followed by the slot/port information.• For a VLAN, enter the keyword vlan followed by a number from 1 to 4094 E-Series ExaScale platforms support 4094 VLANs with FTOS version 8.2.1.0 and later. Earlier ExaScale supports 2094 VLANs. <p>(OPTIONAL) Enter the keyword vrrp to clear statistics for all VRRP groups configured. Enter a number from 1 to 255 as the <i>vrid</i>.</p> <p>(OPTIONAL) Enter the keyword learning-limit to clear unknown source address (SA) drop counters when MAC learning limit is configured on the interface.</p> |

When you enter this command, you must confirm that you want FTOS to clear the interface counters for that interface as shown in the following example.

```
FTOS#clear counters gi 0/0
Clear counters on GigabitEthernet 0/0 [confirm]
FTOS#
```

IPv4 Routing

IPv4 Routing is supported on platforms: e c s **S4810** **S4820T**

FTOS supports various IP addressing features. This chapter explains the basics of Domain Name Service (DNS), Address Resolution Protocol (ARP), and routing principles and their implementation in FTOS.

- IP Addresses
- Directed Broadcast
- Resolution of Host Names
- ARP
- ICMP
- UDP Helper

Table 23-1 lists the defaults for the IP addressing features described in this chapter.

Table 23-1. IP Defaults

| IP Feature | Default |
|--------------------|----------|
| DNS | Disabled |
| Directed Broadcast | Disabled |
| Proxy ARP | Enabled |
| ICMP Unreachable | Disabled |
| ICMP Redirect | Disabled |

IP Addresses

FTOS supports IP version 4, as described in RFC 791. It also supports classful routing and Variable Length Subnet Masks (VLSM). With VLSM one network can be configured with different masks.

Supernetting, which increases the number of subnets, is also supported. Subnetting is when a mask is added to the IP address to separate the network and host portions of the IP address.

At its most basic level, an IP address is 32-bits composed of network and host portions and represented in dotted decimal format. For example,

```
00001010110101100101011110000011
```

is represented as 10.214.87.131.

For more information on IP addressing, refer to [RFC 791](#), *Internet Protocol*.

Implementation Information

In FTOS, you can configure any IP address as a static route except IP addresses already assigned to interfaces.



Note: FTOS versions 7.7.1.0 and later support 31-bit subnet masks (/31, or 255.255.255.254) as defined by RFC 3021. This feature allows you to save two more IP addresses on point-to-point links than 30-bit masks. FTOS supports RFC 3021 with ARP.

Configuration Task List for IP Addresses

The following list includes the configuration tasks for IP addresses:

- [Assign IP addresses to an interface](#) (mandatory)
- [Configure static routes](#) (optional)
- [Configure static routes for the management interface](#) (optional)

For a complete listing of all commands related to IP addressing, refer to the *FTOS Command Line Interface Reference Guide*.

Assign IP addresses to an interface

Assign primary and secondary IP addresses to physical or logical (for example, VLAN or port channel) interfaces to enable IP communication between the E-Series and hosts connected to that interface. In FTOS, you can assign one primary address and up to 255 secondary IP addresses to each interface.

To assign an IP address to an interface, use these commands in the following sequence, starting in the CONFIGURATION mode:

| Step | Command Syntax | Command Mode | Purpose |
|------|---|---------------|--|
| 1 | interface <i>interface</i> | CONFIGURATION | <p>Enter the keyword interface followed by the type of interface and slot/port information:</p> <ul style="list-style-type: none"> • For a 1-Gigabit Ethernet interface, enter the keyword GigabitEthernet followed by the slot/port information. • For a Loopback interface, enter the keyword loopback followed by a number from 0 to 16383. • For the Management interface on the RPM, enter the keyword ManagementEthernet followed by the slot/port information. The slot range is 0-1 and the port range is 0. • For a port channel interface, enter the keyword port-channel followed by a number from 1 to 255 for TeraScale and ExaScale, 1 to 32 for EtherScale. • For a SONET interface, enter the keyword sonet followed by the slot/port information. • For a 10-Gigabit Ethernet interface, enter the keyword TenGigabitEthernet followed by the slot/port information. • For a VLAN interface, enter the keyword vlan followed by a number from 1 to 4094. • For a 40-Gigabit Ethernet interface, enter the keyword fortyGigE followed by the slot/port information. |
| 2 | no shutdown | INTERFACE | Enable the interface. |
| 3 | ip address <i>ip-address</i> <i>mask</i> [secondary] | INTERFACE | <p>Configure a primary IP address and mask on the interface.</p> <ul style="list-style-type: none"> • <i>ip-address mask</i>: IP address must be in dotted decimal format (A.B.C.D) and the mask must be in slash prefix-length format (/24). <p>Add the keyword secondary if the IP address is the interface's backup IP address. You can configure up to eight secondary IP addresses.</p> |

To view the configuration, use the `show config` command in the INTERFACE mode as shown in the example below or `show ip interface` in the EXEC privilege mode as shown in the second example.

```
FTOS(conf-if)#show conf
!
interface GigabitEthernet 0/0
 ip address 10.11.1.1/24
 no shutdown
!
FTOS(conf-if)#
```

```
FTOS#show ip int gi 0/8
GigabitEthernet 0/8 is up, line protocol is up
Internet address is 10.69.8.1/24
Broadcast address is 10.69.8.255
Address determined by config file
MTU is 1554 bytes
Inbound access list is not set
Proxy ARP is enabled
Split Horizon is enabled
Poison Reverse is disabled
ICMP redirects are not sent
ICMP unreachable are not sent

FTOS#
```

Configure static routes

A static route is an IP address that is manually configured and not learned by a routing protocol, such as OSPF. Often, static routes are used as backup routes in case other dynamically learned routes are unreachable.

To configure a static route, use the following command in the CONFIGURATION mode:

| Command Syntax | Command Mode | Purpose |
|--|---------------|--|
| <code>ip route ip-address mask {ip-address interface [ip-address]} [distance] [permanent] [tag tag-value]</code> | CONFIGURATION | <p>Configure a static IP address. Use the following required and optional parameters:</p> <ul style="list-style-type: none"> <code>ip-address</code>: Enter an address in dotted decimal format (A.B.C.D). <code>mask</code>: Enter a mask in slash prefix-length format (/X). <code>interface</code>: Enter an interface type followed by slot/port information. <code>distance</code> range: 1 to 255 (optional). <code>permanent</code>: Keep the static route in the routing table (if <code>interface</code> option is used) even if the interface with the route is disabled. (optional) <code>tag tag-value</code> range: 1 to 4294967295. (optional) |

You can enter as many static IP addresses as necessary.

To view the configured routes, use the **show ip route static** command.

```
FTOS#show ip route static
      Destination          Gateway          Dist/Metric Last Change
      -----
S     2.1.2.0/24           Direct, Nu 0    0/0         00:02:30
S     6.1.2.0/24           via 6.1.20.2, Te 5/0 1/0         00:02:30
S     6.1.2.2/32           via 6.1.20.2, Te 5/0 1/0         00:02:30
S     6.1.2.3/32           via 6.1.20.2, Te 5/0 1/0         00:02:30
S     6.1.2.4/32           via 6.1.20.2, Te 5/0 1/0         00:02:30
S     6.1.2.5/32           via 6.1.20.2, Te 5/0 1/0         00:02:30
S     6.1.2.6/32           via 6.1.20.2, Te 5/0 1/0         00:02:30
S     6.1.2.7/32           via 6.1.20.2, Te 5/0 1/0         00:02:30
S     6.1.2.8/32           via 6.1.20.2, Te 5/0 1/0         00:02:30
S     6.1.2.9/32           via 6.1.20.2, Te 5/0 1/0         00:02:30
S     6.1.2.10/32          via 6.1.20.2, Te 5/0 1/0         00:02:30
S     6.1.2.11/32          via 6.1.20.2, Te 5/0 1/0         00:02:30
S     6.1.2.12/32          via 6.1.20.2, Te 5/0 1/0         00:02:30
S     6.1.2.13/32          via 6.1.20.2, Te 5/0 1/0         00:02:30
S     6.1.2.14/32          via 6.1.20.2, Te 5/0 1/0         00:02:30
S     6.1.2.15/32          via 6.1.20.2, Te 5/0 1/0         00:02:30
S     6.1.2.16/32          via 6.1.20.2, Te 5/0 1/0         00:02:30
S     6.1.2.17/32          via 6.1.20.2, Te 5/0 1/0         00:02:30
S     11.1.1.0/24          Direct, Nu 0    0/0         00:02:30
                                     Direct, Lo 0
```

--More--

FTOS installs a next hop that is on the directly connected subnet of current IP address on the interface (for example, if interface gig 0/0 is on 172.31.5.0 subnet, FTOS installs the static route).

FTOS also installs a next hop that is not on the directly connected subnet but which recursively resolves to a next hop on the interface's configured subnet. For example, if gig 0/0 has ip address on subnet 2.2.2.0 and if 172.31.5.43 recursively resolves to 2.2.2.0, FTOS installs the static route.

- When interface goes down, FTOS withdraws the route.
- When interface comes up, FTOS re-installs the route.
- When recursive resolution is “broken,” FTOS withdraws the route.
- When recursive resolution is satisfied, FTOS re-installs the route.

Configure static routes for the management interface

When an IP address used by a protocol and a static management route exists for the same prefix, the protocol route takes precedence over the static management route.

To configure a static route for the management port, use the following command in the CONFIGURATION mode:

| Command Syntax | Command Mode | Purpose |
|--|---------------|--|
| management route <i>ip-address mask</i> { <i>forwarding-router-address</i> ManagementEthernet <i>slot/port</i> } | CONFIGURATION | Assign a static route to point to the management interface or forwarding router. |

To view the configured static routes for the management port, use the **show ip management-route** command in the EXEC privilege mode.

```
FTOS#show ip route static
      Destination          Gateway                Dist/Metric Last Change
      -----
S     2.1.2.0/24            Direct, Nu 0          0/0         00:02:30
S     6.1.2.0/24            via 6.1.20.2, Te 5/0  1/0         00:02:30
S     6.1.2.2/32            via 6.1.20.2, Te 5/0  1/0         00:02:30
S     6.1.2.3/32            via 6.1.20.2, Te 5/0  1/0         00:02:30
S     6.1.2.4/32            via 6.1.20.2, Te 5/0  1/0         00:02:30
S     6.1.2.5/32            via 6.1.20.2, Te 5/0  1/0         00:02:30
S     6.1.2.6/32            via 6.1.20.2, Te 5/0  1/0         00:02:30
S     6.1.2.7/32            via 6.1.20.2, Te 5/0  1/0         00:02:30
S     6.1.2.8/32            via 6.1.20.2, Te 5/0  1/0         00:02:30
S     6.1.2.9/32            via 6.1.20.2, Te 5/0  1/0         00:02:30
S     6.1.2.10/32           via 6.1.20.2, Te 5/0  1/0         00:02:30
S     6.1.2.11/32           via 6.1.20.2, Te 5/0  1/0         00:02:30
S     6.1.2.12/32           via 6.1.20.2, Te 5/0  1/0         00:02:30
S     6.1.2.13/32           via 6.1.20.2, Te 5/0  1/0         00:02:30
S     6.1.2.14/32           via 6.1.20.2, Te 5/0  1/0         00:02:30
S     6.1.2.15/32           via 6.1.20.2, Te 5/0  1/0         00:02:30
S     6.1.2.16/32           via 6.1.20.2, Te 5/0  1/0         00:02:30
S     6.1.2.17/32           via 6.1.20.2, Te 5/0  1/0         00:02:30
S     11.1.1.0/24           Direct, Nu 0          0/0         00:02:30
      Direct, Lo 0
```

--More--

Directed Broadcast

By default, FTOS drops directed broadcast packets destined for an interface. This default setting provides some protection against Denial of Service (DOS) attacks.

To enable FTOS to receive directed broadcasts, use the following command in the INTERFACE mode:

| Command Syntax | Command Mode | Purpose |
|------------------------------|--------------|----------------------------|
| ip directed-broadcast | INTERFACE | Enable directed broadcast. |

To view the configuration, use the **show config** command in the INTERFACE mode.

Resolution of Host Names

Domain Name Service (DNS) maps host names to IP addresses. This feature simplifies such commands as Telnet and FTP by allowing you to enter a name instead of an IP address.

Dynamic resolution of host names is disabled by default. Unless the feature is enabled, the system resolves only host names entered into the host table with the `ip host` command.

- [Enable dynamic resolution of host names](#)
- [Specify local system domain and a list of domains](#)
- [DNS with traceroute](#)

Enable dynamic resolution of host names

By default, dynamic resolution of host names (DNS) is disabled.

To enable DNS, use the following commands in the CONFIGURATION mode:

| Command Syntax | Command Mode | Purpose |
|--|---------------|--|
| <code>ip domain-lookup</code> | CONFIGURATION | Enable dynamic resolution of host names. |
| <code>ip name-server ip-address</code> <code>[ip-address2 ... ip-address6]</code> | CONFIGURATION | Specify up to 6 name servers. The order you entered the servers determines the order of their use. |

To view current bindings, use the `show hosts` command.

```
FTOS>show host
Default domain is forcel0networks.com
Name/address lookup uses domain service
Name servers are not set
Host                Flags      TTL      Type      Address
-----
ks                   (perm, OK) -      IP        2.2.2.2
patch1              (perm, OK) -      IP        192.68.69.2
tomm-3              (perm, OK) -      IP        192.68.99.2
gxr                  (perm, OK) -      IP        192.71.18.2
f00-3               (perm, OK) -      IP        192.71.23.1
FTOS>
```

To view the current configuration, use the `show running-config resolve` command.

Specify local system domain and a list of domains

If you enter a partial domain, FTOS can search different domains to finish or fully qualify that partial domain. A fully qualified domain name (FQDN) is any name that is terminated with a period/dot. FTOS searches the host table first to resolve the partial domain. The host table contains both statically configured and dynamically learnt host and IP addresses. If FTOS cannot resolve the domain, it tries the domain name assigned to the local system. If that does not resolve the partial domain, FTOS searches the list of domains configured

To configure a domain name, use the following command in the CONFIGURATION mode:

| Command Syntax | Command Mode | Purpose |
|-----------------------------------|---------------|--|
| ip domain-name <i>name</i> | CONFIGURATION | Enter up to 63 characters to configure one domain name for the E-Series. |

To configure a list of domain names, use the following command in the CONFIGURATION mode:

| Command Syntax | Command Mode | Purpose |
|-----------------------------------|---------------|---|
| ip domain-list <i>name</i> | CONFIGURATION | Enter up to 63 characters to configure names to complete unqualified host names. Configure this command up to 6 times to specify a list of possible domain names. FTOS searches the domain names in the order they were configured until a match is found or the list is exhausted. |

DNS with traceroute

To configure your switch to perform DNS with traceroute, follow the steps below in the CONFIGURATION mode.

| Command Syntax | Command Mode | Purpose |
|--|---------------|---|
| ip domain-lookup | CONFIGURATION | Enable dynamic resolution of host names. |
| ip name-server <i>ip-address</i> [<i>ip-address2</i> ... <i>ip-address6</i>] | CONFIGURATION | Specify up to 6 name servers. The order you entered the servers determines the order of their use. |
| traceroute [<i>host</i> <i>ip-address</i>] | CONFIGURATION | When you enter the traceroute command without specifying an IP address (Extended Traceroute), you are prompted for a target and source IP address, timeout in seconds (default is 5), a probe count (default is 3), minimum TTL (default is 1), maximum TTL (default is 30), and port number (default is 33434). To keep the default setting for those parameters, press the ENTER key. |

The following text is an example output of DNS using the **traceroute** command.

```
FTOS#traceroute www.forcel0networks.com

Translating "www.forcel0networks.com"...domain server (10.11.0.1) [OK]
Type Ctrl-C to abort.

-----
Tracing the route to www.forcel0networks.com (10.11.84.18), 30 hops max, 40 byte packets
-----

TTL  Hostname                Probe1      Probe2      Probe3
  1  10.11.199.190            001.000 ms 001.000 ms 002.000 ms
  2  gwegress-sjc-02.forcel0networks.com (10.11.30.126) 005.000 ms 001.000 ms 001.000 ms
  3  fw-sjc-01.forcel0networks.com (10.11.127.254) 000.000 ms 000.000 ms 000.000 ms
  4  www.forcel0networks.com (10.11.84.18) 000.000 ms 000.000 ms 000.000 ms
FTOS#
```

ARP

FTOS uses two forms of address resolution: ARP and Proxy ARP.

Address Resolution Protocol (ARP) runs over Ethernet and enables endstations to learn the MAC addresses of neighbors on an IP network. Over time, FTOS creates a forwarding table mapping the MAC addresses to their corresponding IP address. This table is called the ARP Cache and dynamically learned addresses are removed after a defined period of time.

For more information on ARP, see RFC 826, *An Ethernet Address Resolution Protocol*.

In FTOS, Proxy ARP enables hosts with knowledge of the network to accept and forward packets from hosts that contain no knowledge of the network. Proxy ARP makes it possible for hosts to be ignorant of the network, including subnetting.

For more information on Proxy ARP, refer to RFC 925, *Multi-LAN Address Resolution*, and RFC 1027, *Using ARP to Implement Transparent Subnet Gateways*.

Configuration Task List for ARP

The following list includes configuration tasks for ARP:

- [Configure static ARP entries \(optional\)](#)
- [Enable Proxy ARP \(optional\)](#)
- [Clear ARP cache \(optional\)](#)
- [ARP Learning via Gratuitous ARP](#)
- [ARP Learning via ARP Request](#)
- [Configurable ARP Retries](#)

For a complete listing of all ARP-related commands, refer to the *FTOS Command Line Reference*.

Configure static ARP entries

ARP dynamically maps the MAC and IP addresses, and while most network host support dynamic mapping, you can configure an ARP entry (called a static ARP) for the ARP cache.

To configure a static ARP entry, use the following command in the CONFIGURATION mode:

| Command Syntax | Command Mode | Purpose |
|--|---------------|--|
| arp <i>ip-address mac-address interface</i> | CONFIGURATION | Configure an IP address and MAC address mapping for an interface. <ul style="list-style-type: none"> • <i>ip-address</i>: IP address in dotted decimal format (A.B.C.D). • <i>mac-address</i>: MAC address in nnnn.nnnn.nnnn format • <i>interface</i>: enter the interface type slot/port information. |

These entries do not age and can only be removed manually. To remove a static ARP entry, use the **no arp ip-address** command syntax.

To view the static entries in the ARP cache, use the **show arp static** command in the EXEC privilege mode as shown below.

```
FTOS#show arp
```

```

Protocol      Address          Age (min)  Hardware Address  Interface  VLAN  CPU
-----
Internet     10.1.1.2.4      17        08:00:20:b7:bd:32  Ma 1/0    -     CP
FTOS#

```

Enable Proxy ARP

By default, Proxy ARP is enabled. To disable Proxy ARP, use **no proxy-arp** command in the interface mode.

To re-enable Proxy ARP, use the following command in the INTERFACE mode:

| Command Syntax | Command Mode | Purpose |
|---------------------|--------------|----------------------|
| ip proxy-arp | INTERFACE | Re-enable Proxy ARP. |

To view if Proxy ARP is enabled on the interface, use the **show config** command in the INTERFACE mode. If it is not listed in the **show config** command output, it is enabled. Only nondefault information is displayed in the **show config** command output.

Clear ARP cache

To clear the ARP cache of dynamically learnt ARP information, use the following command in the EXEC privilege mode:

| Command Syntax | Command Mode | Purpose |
|--|----------------|---|
| <code>clear arp-cache</code> [<i>interface</i> <i>ip ip-address</i>] [<i>no-refresh</i>] | EXEC privilege | <p>Clear the ARP caches for all interfaces or for a specific interface by entering the following information:</p> <ul style="list-style-type: none">• For a 1-Gigabit Ethernet interface, enter the keyword GigabitEthernet followed by the slot/port information.• For a port channel interface, enter the keyword port-channel followed by a number from 1 to 255 for TeraScale and ExaScale, 1 to 32 for EtherScale.• For a SONET interface, enter the keyword sonet followed by the slot/port information.• For a 10-Gigabit Ethernet interface, enter the keyword TenGigabitEthernet followed by the slot/port information.• For a VLAN interface, enter the keyword vlan followed by a number between 1 and 4094.• For a 40-Gigabit Ethernet interface, enter the keyword fortyGigE followed by the slot/port information. <p>ip ip-address (OPTIONAL) Enter the keyword ip followed by the IP address of the ARP entry you wish to clear.</p> <p>no-refresh (OPTIONAL) Enter the keyword no-refresh to delete the ARP entry from CAM. Or use this option with <i>interface</i> or ip ip-address to specify which dynamic ARP entries you want to delete.</p> <p>Note: Transit traffic may not be forwarded during the period when deleted ARP entries are resolved again and re-installed in CAM. Use this option with extreme caution.</p> |

ARP Learning via Gratuitous ARP

Gratuitous ARP can mean an ARP request or reply. In the context of ARP Learning via Gratuitous ARP on FTOS, the gratuitous ARP is a request. A Gratuitous ARP Request is an ARP request that is not needed according to the ARP specification, but one that hosts may send to:

- detect IP address conflicts
- inform switches of their presence on a port so that packets can be forwarded
- update the ARP table of other nodes on the network in case of an address change

In the request, the host uses its own IP address in the Sender Protocol Address and Target Protocol Address fields.

In FTOS versions prior to 8.3.1.0, if a gratuitous ARP is received some time after an ARP request is sent, only RP2 installs the ARP information. For example:

1. At time $t=0$ FTOS sends an ARP request for IP $A.B.C.D$
2. At time $t=1$ FTOS receives an ARP request for IP $A.B.C.D$
3. At time $t=2$ FTOS installs an ARP entry for $A.B.C.D$ only on RP2.

Beginning with version 8.3.1.0, when a Gratuitous ARP is received, FTOS installs an ARP entry on all 3 CPUs.

| Task | Command Syntax | Command Mode |
|---|-------------------------------|---------------|
| Enable ARP learning via gratuitous ARP. | <code>arp learn-enable</code> | CONFIGURATION |

ARP Learning via ARP Request

In FTOS versions prior to 8.3.1.0, FTOS learns via ARP Requests only if the Target IP specified in the packet matches the IP address of the receiving router interface. This is the case when a host is attempting to resolve the gateway address.

If the Target IP does not match the incoming interface, then the packet is dropped. If there is an existing entry for the requesting host, it is updated.

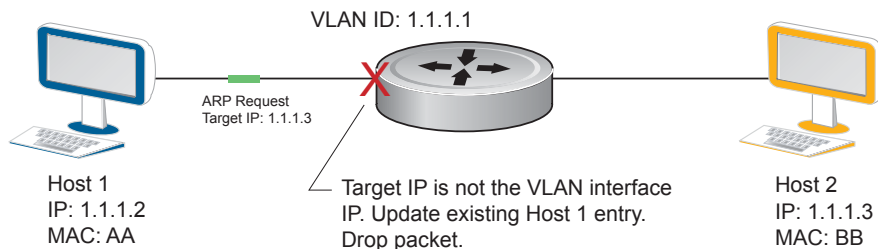

Beginning with FTOS version 8.3.1.0, when ARP Learning via Gratuitous ARP is enabled, the system installs a new ARP entry, or updates an existing entry for all received ARP requests.

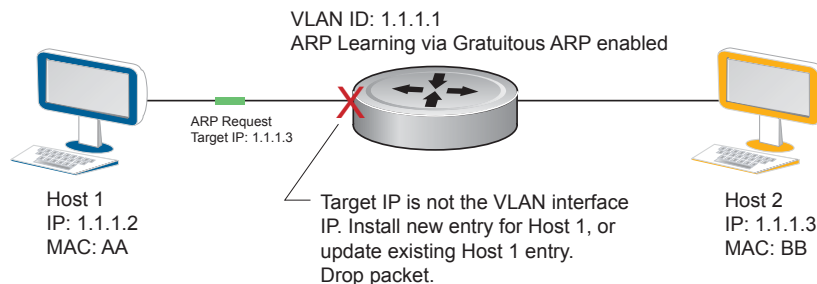

Whether ARP Learning via Gratuitous ARP is enabled or disabled, the system does not look up the Target IP. It only updates the ARP entry for the Layer 3 interface with the source IP of the request.

Configurable ARP Retries

In FTOS versions prior to 8.3.1.0, the number of ARP retries is set to 5 and is not configurable. After 5 retries, FTOS backs off for 20 seconds before it sends a new request. Beginning with FTOS version 8.3.1.0, the number of ARP retries is configurable.

The default backoff interval remains at 20 seconds. On the S4810 and S4820T platforms, with FTOS version 8.3.8.0 and later, the time between ARP resend is configurable. This timer is an exponential backoff timer. Over the specified period, the time between ARP requests increases. This reduces the potential for the system to slow down while waiting for a multitude of ARP responses.

| Task | Command Syntax | Command Mode |
|---|---|----------------|
| Set the number of ARP retries. | arp retries <i>number</i> Default: 5 Range: 1-20 | CONFIGURATION |
| Set the an exponential timer for resending unresolved ARPs. | arp backoff-time Default: 30 Range: 1 to 3600 | CONFIGURATION |
| Display all ARP entries learned via gratuitous ARP. | show arp retries | EXEC Privilege |

ICMP

For diagnostics, Internet Control Message Protocol (ICMP) provides routing information to end stations by choosing the best route (ICMP redirect messages) or determining if a router is reachable (ICMP Echo or Echo Reply). ICMP Error messages inform the router of problems in a particular packet. These messages are sent only on unicast traffic.

Configuration Task List for ICMP

Use the following steps to configure ICMP:

- [Enable ICMP unreachable messages](#)
- [Enable ICMP redirects](#)

See the *FTOS Command Line Reference Guide* for a complete listing of all commands related to ICMP.

Enable ICMP unreachable messages

By default, ICMP unreachable messages are disabled. When enabled ICMP unreachable messages are created and sent out all interfaces. To disable ICMP unreachable messages, use the **no ip unreachable** command.

To reenable the creation of ICMP unreachable messages on the interface, use the following command in the INTERFACE mode:

| Command Syntax | Command Mode | Purpose |
|-----------------------|--------------|---|
| ip unreachable | INTERFACE | Set FTOS to create and send ICMP unreachable messages on the interface. |

To view if ICMP unreachable messages are sent on the interface, use the **show config** command in the INTERFACE mode. If it is not listed in the **show config** command output, it is enabled. Only nondefault information is displayed in the **show config** command output.

Enable ICMP redirects

[Enable ICMP redirects](#) is supported on  platform.

By default, ICMP redirect messages are disabled. When enabled, ICMP redirect messages are created and sent out all interfaces. To disable ICMP redirect messages, use the **no ip redirect** command.

To reenable the creation of ICMP redirect messages on the interface, use the following command in the INTERFACE mode:

| Command Syntax | Command Mode | Purpose |
|--------------------|--------------|--|
| ip redirect | INTERFACE | Set FTOS to create and send ICMP redirect messages on the interface. |

To view if ICMP redirect messages are sent on the interface, use the **show config** command in the INTERFACE mode. If it is not listed in the **show config** command output, it is enabled. Only nondefault information is displayed in the **show config** command output.

UDP Helper

UDP helper allows you to direct the forwarding IP/UDP broadcast traffic by creating special broadcast addresses and rewriting the destination IP address of packets to match those addresses. Configurations using this feature are described in the section [Configurations Using UDP Helper](#).

Configuring UDP Helper

Configuring FTOS to direct UDP broadcast is a two-step process:

1. Enable UDP helper and specify the UDP ports for which traffic is forwarded. Refer to [Enabling UDP Helper](#).

2. Configure a broadcast address on interfaces that will receive UDP broadcast traffic. Refer to [Configuring a Broadcast Address](#).

Important Points to Remember about UDP Helper

- The existing command **ip directed broadcast** is rendered meaningless if UDP helper is enabled on the same interface.
- The broadcast traffic rate should not exceed 200 packets per second when UDP helper is enabled.
- You may specify a maximum of 16 UDP ports.
- UDP helper is compatible with IP helper (**ip helper-address**):
 - UDP broadcast traffic with port number 67 or 68 are unicast to the DHCP server per the **ip helper-address** configuration whether or not the UDP port list contains those ports.
 - If the UDP port list contains ports 67 or 68, UDP broadcast traffic forwarded on those ports.

Enabling UDP Helper

Enable UDP helper using the command **ip udp-helper udp-ports**, as shown in the example below.

```
FTOS(conf-if-gi-1/1)#ip udp-helper udp-port 1000
FTOS(conf-if-gi-1/1)#show config
!
interface GigabitEthernet 1/1
 ip address 2.1.1.1/24
 ip udp-helper udp-port 1000
 no shutdown
```

View the interfaces and ports on which UDP helper is enabled using the command **show ip udp-helper** from EXEC Privilege mode, as shown in the following example.

```
FTOS#show ip udp-helper
-----
Port          UDP port list
-----
Gi 1/1       1000
```

Configuring a Broadcast Address

Configure a broadcast address on an interface using the command `ip udp-broadcast-address`, as shown in the example below.

```
FTOS(conf-if-vl-100)#ip udp-broadcast-address 1.1.255.255
FTOS(conf-if-vl-100)#show config
!
interface Vlan 100
 ip address 1.1.0.1/24
 ip udp-broadcast-address 1.1.255.255
 untagged GigabitEthernet 1/2
 no shutdown
```

View the configured broadcast address for an interface using the command `show interfaces`, as shown in the following example.

```
R1_E600(conf)#do show interfaces vlan 100
Vlan 100 is up, line protocol is down
Address is 00:01:e8:0d:b9:7a, Current address is 00:01:e8:0d:b9:7a
Interface index is 1107787876
Internet address is 1.1.0.1/24
IP UDP-Broadcast address is 1.1.255.255
MTU 1554 bytes, IP MTU 1500 bytes
LineSpeed auto
ARP type: ARPA, ARP Timeout 04:00:00
Last clearing of "show interface" counters 00:07:44
Queueing strategy: fifo
Input Statistics:
    0 packets, 0 bytes
Time since last interface status change: 00:07:44
```

Configurations Using UDP Helper

When UDP helper is enabled and the destination IP address of an incoming packet is a broadcast address, FTOS suppresses the destination address of the packet. The following sections describe various configurations that employ UDP helper to direct broadcasts.

- [UDP Helper with Broadcast-all Addresses](#)
- [UDP Helper with Subnet Broadcast Addresses](#)
- [UDP Helper with Configured Broadcast Addresses](#)
- [UDP Helper with No Configured Broadcast Addresses](#)

UDP Helper with Broadcast-all Addresses

When the destination IP address of an incoming packet is the IP broadcast address, FTOS rewrites the address to match the configured broadcast address.

In the illustration below:

1. Packet 1 is dropped at ingress if no UDP helper address is configured.
2. If UDP helper (using the command `ip udp-helper udp-port`) is enabled, and the UDP destination port of the packet matches the UDP port configured, the system changes the destination address to the configured broadcast 1.1.255.255 and routes the packet to VLANs 100 and 101. If an IP broadcast address is not configured (using the command `ip udp-broadcast-address`) on VLANs 100 or 101, the packet is forwarded using the original destination IP address 255.255.255.255.

Packet 2, sent from a host on VLAN 101 has a broadcast MAC address and IP address. In this case:

1. It is flooded on VLAN 101 without changing the destination address because the forwarding process is Layer 2.
2. If UDP helper is enabled, the system changes the destination IP address to the configured broadcast address 1.1.255.255 and forwards the packet to VLAN 100.
3. Packet 2 is also forwarded to the ingress interface with an unchanged destination address because it does not have broadcast address configured.

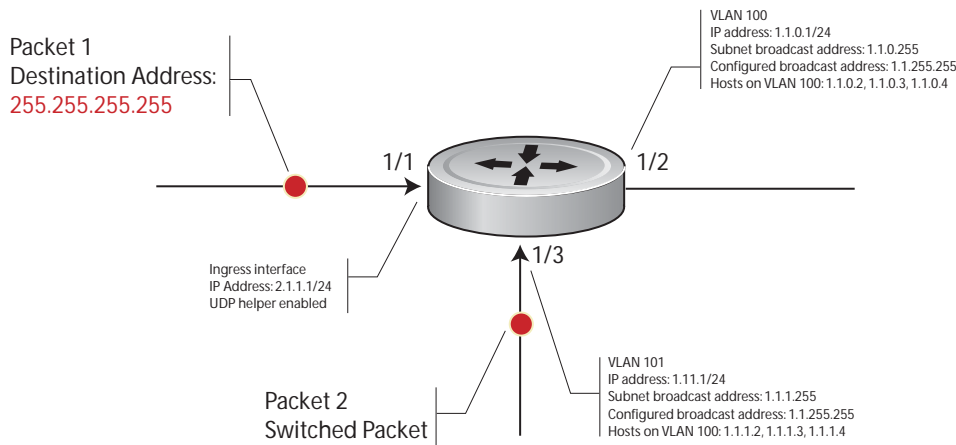

UDP Helper with Subnet Broadcast Addresses

When the destination IP address of an incoming packet matches the subnet broadcast address of any interface, the system changes the address to the configured broadcast address and sends it to matching interface.

In the following illustration, Packet 1 has the destination IP address 1.1.1.255, which matches the subnet broadcast address of VLAN 101. If UDP helper is configured and the packet matches the specified UDP port, then the system changes the address to the configured IP broadcast address and floods the packet on VLAN 101.

Packet 2 is sent from host on VLAN 101. It has a broadcast MAC address and a destination IP address of 1.1.1.255. In this case, it is flooded on VLAN 101 in its original condition as the forwarding process is Layer 2.

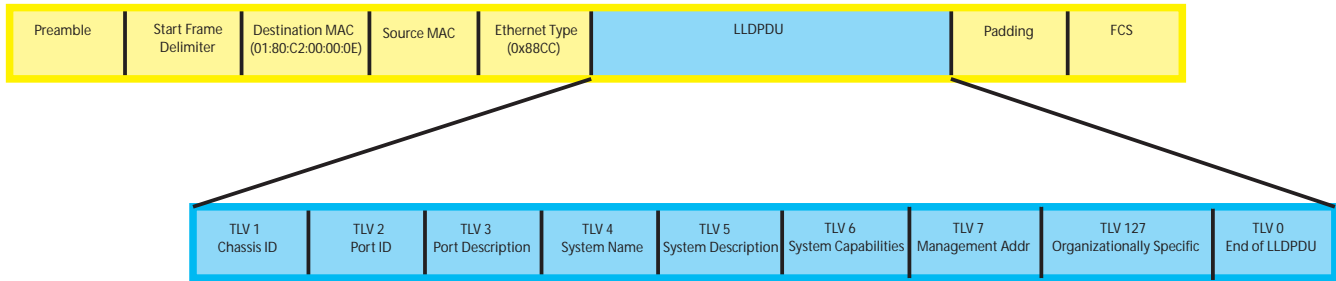

UDP Helper with Configured Broadcast Addresses

Incoming packets with a destination IP address matching the configured broadcast address of any interface are forwarded to the matching interfaces.

In the following illustration, Packet 1 has a destination IP address that matches the configured broadcast address of VLAN 100 and 101. If UDP helper is enabled and the UDP port number matches, the packet is flooded on both VLANs with an unchanged destination address.

Packet 2 is sent from a host on VLAN 101. It has broadcast MAC address and a destination IP address that matches the configured broadcast address on VLAN 101. In this case, Packet 2 is flooded on VLAN 101 with the destination address unchanged because the forwarding process is Layer 2. If UDP helper is enabled, the packet is flooded on VLAN 100 as well.

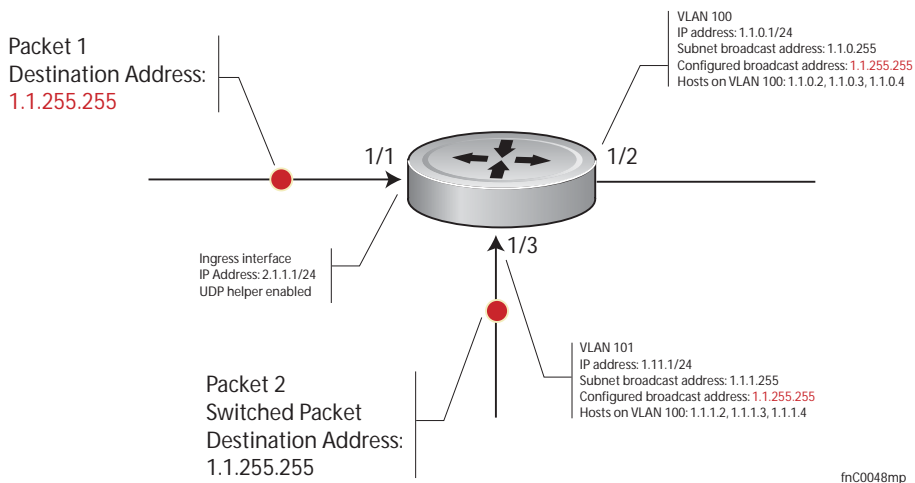

UDP Helper with No Configured Broadcast Addresses

- If the incoming packet has a broadcast destination IP address, then the unaltered packet is routed to all Layer 3 interfaces.
- If the Incoming packet has a destination IP address that matches the subnet broadcast address of any interface, then the unaltered packet is routed to the matching interfaces.

Troubleshooting UDP Helper

Display debugging information using the command **debug ip udp-helper**, as shown in the example below.

```
FTOS(conf)# debug ip udp-helper
01:20:22: Pkt rcvd on Gi 5/0 with IP DA (0xffffffff) will be sent on Gi 5/1 Gi 5/2 Vlan 3
01:44:54: Pkt rcvd on Gi 7/0 is handed over for DHCP processing.
```

Use the command **debug ip dhcp** when using the IP helper and UDP helper on the same interface, as shown in the following example.

```
Packet 0.0.0.0:68 -> 255.255.255.255:67 TTL 128
```

```
2005-11-05 11:59:35 %RELAY-I-PACKET, BOOTP REQUEST (Unicast) received at interface
172.21.50.193 BOOTP Request, XID = 0x9265f901, secs = 0 hwaddr = 00:02:2D:8D:46:DC,
giaddr = 0.0.0.0, hops = 2
```

```
2005-11-05 11:59:35 %RELAY-I-BOOTREQUEST, Forwarded BOOTREQUEST for 00:02:2D:8D:46:DC
to 137.138.17.6
```

```
2005-11-05 11:59:36 %RELAY-I-PACKET, BOOTP REPLY (Unicast) received at interface
194.12.129.98 BOOTP Reply, XID = 0x9265f901, secs = 0 hwaddr = 00:02:2D:8D:46:DC,
giaddr = 172.21.50.193, hops = 2
```

```
2005-07-05 11:59:36 %RELAY-I-BOOTREPLY, Forwarded BOOTREPLY for 00:02:2D:8D:46:DC to
128.141.128.90 Packet 0.0.0.0:68 -> 255.255.255.255:67 TTL 128
```

iSCSI Optimization

iSCSI Optimization is supported on platforms **S4810** and **S4820T**

This chapter describes how to configure internet small computer system interface (iSCSI) optimization, which enables quality-of-service (QoS) treatment for iSCSI traffic. The topics covered in this chapter include:

- [iSCSI Optimization Overview](#)
- [Default iSCSI Optimization Values](#)
- [iSCSI Optimization Prerequisites](#)
- [Configuring iSCSI Optimization](#)
- [Displaying iSCSI Optimization Information](#)

iSCSI Optimization Overview

iSCSI is a TCP/IP-based protocol for establishing and managing connections between IP-based storage devices and initiators in a storage area network (SAN).

iSCSI optimization provides a means of monitoring iSCSI sessions and applying QoS policies on iSCSI traffic. When enabled, iSCSI optimization allows a switch to monitor (snoop) the establishment and termination of iSCSI connections. The switch uses the snooped information to detect iSCSI sessions and connections established through the switch.

iSCSI optimization allows you to reduce deployment time and management complexity in data centers. In a data center network, Dell EqualLogic and Compellent iSCSI storage arrays are connected to a converged Ethernet network using the data center bridging exchange protocol (DCBX) through stacked and/or non-stacked Ethernet switches.

iSCSI optimization functions as follows:

- Auto-detection of EqualLogic storage arrays — The switch detects any active EqualLogic array directly attached to its ports.
- Manual configuration to detect Compellent storage arrays where auto-detection is not supported.
- Automatic configuration of switch ports after detection of storage arrays.
- iSCSI monitoring sessions — The switch monitors and tracks active iSCSI sessions in connections on the switch, including port information and iSCSI session information.

- iSCSI QoS—A user-configured iSCSI class of service (CoS) profile is applied to all iSCSI traffic. Classifier rules are used to direct the iSCSI data traffic to queues that can be given preferential QoS treatment over other data passing through the switch. Preferential treatment helps to avoid session interruptions during times of congestion that would otherwise cause iSCSI packets to be dropped.
- iSCSI DCBX TLVs are supported.

Figure 24-1 shows iSCSI optimization between servers and a storage array in which a stack of three switches connect installed servers (iSCSI initiators) to a storage array (iSCSI targets) in a SAN network. iSCSI optimization running on the master switch is configured to use dot1p priority-queue assignments to ensure that iSCSI traffic in these sessions receives priority treatment when forwarded on stacked switch hardware.

Figure 24-1. iSCSI Optimization Example

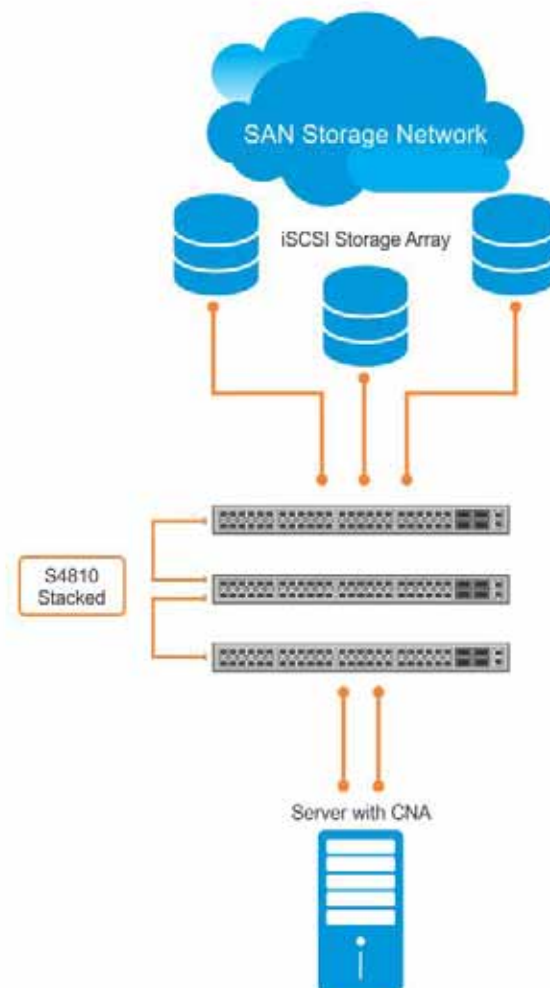

Monitoring iSCSI Traffic Flows

The switch snoops iSCSI session-establishment and termination packets by installing classifier rules that trap iSCSI protocol packets to the CPU for examination. Devices that initiate iSCSI sessions usually use well-known TCP ports 3260 or 860 to contact targets. When you enable iSCSI optimization, by default the switch identifies IP packets to or from these ports as iSCSI traffic.

You can configure the switch to monitor traffic for additional port numbers or a combination of port number and target IP address, and you can remove the well-known port numbers from monitoring.

Application of Quality of Service to iSCSI Traffic Flows

The iSCSI CoS mode is user-configurable and controls whether CoS (dot1p priority) queue assignment and/or packet marking is performed on iSCSI traffic. When you enable iSCSI CoS mode, the CoS policy is applied to iSCSI traffic. When you disable iSCSI CoS mode, iSCSI sessions and connections are still detected and displayed in the status tables, but no CoS policy is applied to iSCSI traffic.

You can configure whether the iSCSI optimization feature uses the VLAN priority or IP DSCP mapping to determine the traffic class queue. By default, iSCSI flows are assigned to dot1p priority 4. Use the CoS dot1p-priority command to map incoming iSCSI traffic on an interface to a dot1p priority-queue other than 4 (refer to [QoS dot1p Traffic Classification and Queue Assignment](#)). Dell Force10 recommends setting the CoS dot1p priority-queue to 0 (zero).

You can configure whether iSCSI frames are re-marked to contain the configured VLAN priority tag or IP DSCP when forwarded through the switch.



Note: On a switch in which a large proportion of traffic is iSCSI, CoS queue assignments may interfere with other network control-plane traffic, such as ARP or LACP. Preferential treatment of iSCSI traffic needs to be balanced against the needs of other critical data in the network.

Information Monitored in iSCSI Traffic Flows

iSCSI optimization examines the following data in packets and uses the data to track the session and create the classifier entries that enable QoS treatment:

- Initiator's IP Address
- Target's IP Address
- ISID (Initiator defined session identifier)
- Initiator's IQN (iSCSI qualified name)
- Target's IQN
- Initiator's TCP Port
- Target's TCP Port
- Connection ID
- Aging
- Up Time

If no iSCSI traffic is detected for a session during a user-configurable aging period, the session data is cleared.

If more than 256 simultaneous sessions are logged continuously, the following message displays indicating the queue rate limit has been reached.

```
%STKUNIT2-M:CP %iSCSI-5-ISCASI_OPT_MAX_SESS_EXCEEDED: New iSCSI Session Ignored: ISID -
400001370000 InitiatorName - iqn.1991-05.com.microsoft:dt-brcd-cna-2 TargetName -
iqn.2001-05.com.equallogic:4-52aed6-b90d9446c-162466364804fa49-wj-v1 TSIH - 0"
```

Detection and Auto-configuration for Dell EqualLogic Arrays

The iSCSI optimization feature includes auto-provisioning support with the ability to detect directly connected Dell EqualLogic storage arrays and automatically reconfigure the switch to enhance storage traffic flows.

The switch uses the link layer discovery protocol (LLDP) to discover Dell EqualLogic devices on the network. LLDP is enabled by default. For more information about LLDP, refer to [Chapter 29, Link Layer Discovery Protocol \(LLDP\)](#).

The following message is displayed the first time a Dell EqualLogic array is detected and describes the configuration changes that are automatically performed:

```
%STKUNIT0-M:CP %IFMGR-5-IFM_ISCSI_AUTO_CONFIG: This switch is being configured for optimal
conditions to support iSCSI traffic which will cause some automatic configuration to occur
including jumbo frames and flow-control on all ports; no storm control and spanning-tree port
fast to be enabled on the port of detection.
```

The following syslog message is generated the first time an EqualLogic array is detected:

```
%STKUNIT0-M:CP %LLDP-5-LLDP_EQL_DETECTED: EqualLogic Storage Array detected on interface Te 1/
43
```

- At the first detection of an EqualLogic array, an MTU of 12000 is enabled on all ports and port-channels (if it has not already been enabled).
- Spanning-tree portfast is enabled on the interface identified by LLDP.
- Unicast storm control is disabled on the interface identified by LLDP.

Detection and Port Configuration for Dell Compellent Arrays

Switches support the `iscsi profile-compellent` command to configure a port connected to a Dell Compellent storage array. The command configures a port for the best iSCSI traffic conditions and must be entered in INTERFACE Configuration mode.

The following message is displayed the first time you use the **iscsi profile-compellent** command to configure a port connected to a Dell Compellent storage array and describes the configuration changes that are automatically performed:

```
%STKUNIT0-M:CP %IFMGR-5-IFM_ISCSI_AUTO_CONFIG: This switch is being configured for optimal conditions to support iSCSI traffic which will cause some automatic configuration to occur including jumbo frames and flow-control on all ports; no storm control and spanning-tree port fast to be enabled on the port of detection.
```

After you execute the **iscsi profile-compellent** command, the following actions occur:

- Jumbo frame size is set to 12000 for all interfaces on all ports and port-channels, if it is not already enabled.
- Spanning-tree portfast is enabled on the interface.
- Unicast storm control is disabled on the interface.

You must enter the **iscsi profile-compellent** command in INTERFACE configuration mode; for example:

```
FTOS(conf-if-te-o/50# iscsi profile-compellent
```

Enabling and Disabling iSCSI Optimization



Note: iSCSI monitoring is disabled by default. iSCSI auto-configuration and auto-detection is enabled by default.

When you enable iSCSI on the switch, the following actions occur:

- Link-level flow control is globally enabled, if it is not already enabled, and PFC is disabled.
- iSCSI session snooping is enabled.
- iSCSI LLDP monitoring starts to automatically detect EqualLogic arrays.

The following message is displayed when you enable iSCSI on a switch and describes the configuration changes that are automatically performed:

```
%STKUNIT0-M:CP %IFMGR-5-IFM_ISCSI_ENABLE: iSCSI has been enabled causing flow control to be enabled on all interfaces. EQL detection and enabling iscsi profile-compellent on an interface may cause some automatic configurations to occur like jumbo frames on all ports and no storm control and spanning tree port-fast on the port of detection.
```

You can reconfigure any of the auto-provisioned configuration settings that result when you enable iSCSI on a switch.

When you disable the iSCSI feature, iSCSI resources are released and the detection of EqualLogic arrays using LLDP is disabled. Disabling iSCSI does not remove the MTU, flow control, portfast, or storm control configuration applied as a result of enabling iSCSI.



Note: By default, CAM allocation for iSCSI is set to 0. This disables session monitoring.

Default iSCSI Optimization Values

Table 24-1 shows the default values for the iSCSI optimization feature.

Table 24-1. iSCSI Optimization: Default Parameters

| Parameter | Default Value |
|--|---|
| iSCSI Optimization global setting | Enabled |
| iSCSI CoS mode (802.1p priority queue mapping) | Enabled: dot1p priority 4 without remark setting |
| iSCSI CoS Packet classification | iSCSI packets are classified by VLAN instead of by DSCP values. |
| VLAN priority tag | iSCSI flows are assigned by default to dot1p priority 4 without remark setting. |
| DSCP | None: user-configurable. |
| Remark | Not configured. |
| iSCSI session aging time | 10 minutes |
| iSCSI optimization target ports | iSCSI well-known ports 3260 and 860 are configured as default (with no IP address or name) but can be removed as any other configured target. |

iSCSI Optimization Prerequisites

- iSCSI optimization requires LLDP on the switch. LLDP is enabled by default (refer to [Chapter 29, Link Layer Discovery Protocol \(LLDP\)](#)).
- iSCSI optimization requires two ingress ACL groups to be configured. The ACL groups are allocated after iSCSI Optimization is configured. (refer to [When to Use CAM Profiling](#)).

Configuring iSCSI Optimization

To configure iSCSI optimization on a switch, follow these steps:

| Step | Task | Command | Command Mode |
|------|---|--|----------------|
| 1 | Configure iSCSI Optimization. The configuration files are stored in the flash memory in the CONFIG_TEMPLATE file. Note: DCB/DCBx will be enabled when the iSCSI configuration is applied. | iSCSI configuration: copy flash:/ CONFIG_TEMPLATE/ iSCSI_DCB_Config running-config | |
| 2 | Save the configuration on the switch. | write memory | EXEC Privilege |
| 3 | Reload the switch. After the switch is reloaded, DCB/DCBX and iSCSI monitoring will be enabled. | reload | EXEC Privilege |

| Step | Task | Command | Command Mode |
|------|--|--|----------------------------------|
| 4 | <p>Configure the iSCSI target ports and optionally the IP addresses on which iSCSI communication will be monitored, where:</p> <ul style="list-style-type: none"> <i>tcp-port-n</i> is the TCP port number or a list of TCP port numbers on which the iSCSI target listens to requests. You can configure up to 16 target TCP ports on the switch in one command or multiple commands. Default: 860, 3260. Separate port numbers with a comma. <i>ip-address</i> specifies the IP address of the iSCSI target. When you enter the <i>no</i> form of the command, and the TCP port to be deleted is one bound to a specific IP address, the IP address value must be included in the command. | <pre>[no] iscsi target port tcp-port-1 [<i>tcp-port-2...tcp-port-16</i>] [address <i>ip-address</i>]</pre> | CONFIGURATION |
| 5 | <p>Set the QoS policy that will be applied to iSCSI flows, where:</p> <ul style="list-style-type: none"> enable: enables the application of preferential QoS treatment to iSCSI traffic so that iSCSI packets are scheduled in the switch with a dot1p priority 4 regardless of the VLAN priority tag in the packet. Default: iSCSI packets are handled with dotp1 priority 4 without remark. disable: disables the application of preferential QoS treatment to iSCSI frames. dot1p <i>vlan-priority-value</i>: specifies the VLAN priority tag assigned to incoming packets in an iSCSI session. Range: 0 to 7. Default: The dot1p value in ingress iSCSI frames is not changed and is used in iSCSI TLV advertisements if the <i>iscsi priority-bits</i> command is not entered (Step 5). dscp <i>dscp-value</i>: specifies the DSCP value assigned to incoming packets in an iSCSI session. Range: 0 to 63. Default: The DSCP value in ingress packets is not changed. remark: marks incoming iSCSI packets with the configured dot1p or DSCP value when they egress the switch. Default: The dot1 and DSCP values in egress packets are not changed. | <pre>[no] iscsi cos {enable disable dot1p <i>vlan-priority-value</i> [remark] dscp <i>dscp-value</i> [remark]}</pre> | CONFIGURATION |
| 6 | <p>Set the aging time for iSCSI session monitoring. Range: 5 to 43,200 minutes. Default: 10 minutes.</p> | <pre>[no] iscsi aging time <i>time</i></pre> | CONFIGURATION |
| 7 | <p>(Optional) Configures DCBX to send iSCSI TLV advertisements. You can configure iSCSI TLVs to be sent either globally or on a specified interface. The interface configuration takes priority over global configuration. Default: Enabled.</p> | <pre>[no] advertise dcbx-app-tlv iscsi</pre> | CONFIGURATION or INTERFACE |
| 8 | <p>(Optional) Configures the priority bitmap to be advertised in iSCSI application TLVs. Default: 4 (0x10 in the bitmap).</p> | <pre>[no] iscsi priority-bits</pre> | CONFIGURATION |

| Step | Task | Command | Command Mode |
|------|---|--|---------------|
| 9 | (Optional) Enter interface configuration mode to configure the auto-detection of Compellent disk arrays. | <code>interface port-type slot/port</code> | CONFIGURATION |
| 10 | (Optional) Configures the auto-detection of Compellent arrays on a port. Default: Compellent disk arrays are not detected. | <code>[no] iscsi profile-compellent</code> | INTERFACE |

Displaying iSCSI Optimization Information

Use the show commands in [Table 24-2](#) to display information on iSCSI optimization.

Table 24-2. Displaying iSCSI Optimization Information

| Command | Output |
|--|---|
| <code>show iscsi</code> (Figure 24-2) | Displays the currently configured iSCSI settings. |
| <code>show iscsi sessions</code> (Figure 24-3) | Displays information on active iSCSI sessions on the switch. |
| <code>show iscsi sessions detailed [session isid]</code> (Figure 24-4) | Displays detailed information on active iSCSI sessions on the switch. To display detailed information on specified iSCSI session, enter the session's iSCSI ID. |
| <code>show run iscsi</code> | Displays all globally-configured non-default iSCSI settings in the current FTOS session. |

Figure 24-2. show iscsi Command Example

```
FTOS#show iscsi
iSCSI is enabled
iSCSI session monitoring is disabled
iSCSI COS : dot1p is 4 no-remark
Session aging time: 10
Maximum number of connections is 256
-----
iSCSI Targets and TCP Ports:
-----
TCP Port      Target IP Address
3260
860
```

Figure 24-3. show iscsi session Command Example

```
FTOS#show iscsi session
Session 0:
-----
Target: iqn.2001-05.com.equallogic:0-8a0906-0e70c2002-10a0018426a48c94-iom010
Initiator: iqn.1991-05.com.microsoft:win-x918v27yajg
ISID: 400001370000

Session 1:
-----
Target: iqn.2001-05.com.equallogic:0-8a0906-0f60c2002-0360018428d48c94-iom011
Initiator: iqn.1991-05.com.microsoft:win-x918v27yajg
ISID: 400001370000.
```

Figure 24-4. show iscsi session detailed Command Example

```
FTOS# show iscsi session detailed
Session 0      :
-----
Target:iqn.2010-11.com.ixia:ixload:iscsi-TG1
Initiator:iqn.2010-11.com.ixia.ixload:initiator-iscsi-2c
Up Time:00:00:01:28 (DD:HH:MM:SS)
Time for aging out:00:00:09:34 (DD:HH:MM:SS)
ISID:806978696102
Initiator      Initiator      Target      Target      Connection
IP Address    TCP Port      IP Address  TCPPort     ID
10.10.0.44    33345        10.10.0.101 3260        0
Session 1      :
-----
Target:iqn.2010-11.com.ixia:ixload:iscsi-TG1
Initiator:iqn.2010-11.com.ixia.ixload:initiator-iscsi-35
Up Time:00:00:01:22 (DD:HH:MM:SS)
Time for aging out:00:00:09:31 (DD:HH:MM:SS)
ISID:806978696102
Initiator      Initiator      Target      Target      Connection
IP Address    TCP Port      IP Address  TCPPort     ID
10.10.0.53    33432        10.10.0.101 3260        0
```

Intermediate System to Intermediate System

Intermediate System to Intermediate System is supported on the  **S4810** and **S4820T** platforms.

IS-IS is supported on the E-Series ExaScale platform with FTOS 8.1.1.0 and later. It is supported on the **S4810** and **S4820T** with FTOS 8.3.10.0.

Intermediate System to Intermediate System (IS-IS) protocol is an interior gateway protocol (IGP) that uses a shortest-path-first algorithm. Dell Force10 supports both IPv4 and IPv6 versions of IS-IS, as it is detailed in this chapter.

- [Protocol Overview on page 513](#)
- [IS-IS Addressing on page 514](#)
- [Multi-Topology IS-IS on page 515](#)
- [Graceful Restart on page 516](#)
- [Implementation Information on page 517](#)
- [Configuration Information on page 518](#)
- [IS-IS Metric Styles on page 537](#)
- [Sample Configuration on page 541](#)

IS-IS protocol standards are listed in the [Chapter 56, Standards Compliance](#) chapter.

Protocol Overview

The intermediate-system-to-intermediate-system (IS-IS) protocol, developed by the International Organization for Standardization (ISO), is an interior gateway protocol (IGP) that uses a shortest-path-first algorithm.



Note: This protocol supports routers passing both IP and OSI traffic, though the Dell Force10 implementation supports only IP traffic.

IS-IS is organized hierarchally into routing domains, and each router or system resides in at least one area. In IS-IS, routers are designated as Level 1, Level 2 or Level 1-2 systems. Level 1 routers only route traffic within an area, while Level 2 routers route traffic between areas. At its most basic, Level 1 systems route traffic within the area and any traffic destined for outside the area is sent to a Level 1-2 system. Level 2

systems manage destination paths for external routers. Only Level 2 routers can exchange data packets or routing information directly with external routers located outside of the routing domains. Level 1-2 systems manage both inter-area and intra-area traffic by maintaining two separate link databases; one for Level 1 routes and one for Level 2 routes. A Level 1-2 router does not advertise Level 2 routes to a Level 1 router.

To establish adjacencies, each IS-IS router sends different Protocol Data Units (PDU). For IP traffic, the IP addressing information is included in the IS-IS hello PDUs and the Link State PDUs (LSPs).

This brief overview is not intended to provide a complete understanding of IS-IS; for that, consult the documents listed in [Multi-Topology IS-IS](#).

IS-IS Addressing

IS-IS PDUs require ISO-style addressing called Network Entity Title (NET). For those familiar with NSAP addresses, the composition of the NET is identical to an NSAP address, except the last byte is always 0. The NET is composed of IS-IS area address, system ID, and the N-selector. The last byte is the N-selector. All routers within an area have the same area portion. Level 1 routers route based on the system address portion of the address, while the Level 2 routers route based on the area address.

The NET length is variable, with a maximum of 20 bytes and a minimum of 8 bytes. It is composed of the following:

- area address. Within your routing domain or area, each area must have a unique area value. The first byte is called the authority and format indicator (AFI).
- system address. This is usually the router's MAC address.
- N-selector. This is always 0.

Figure 25-1 is an example of the ISO-style address to illustrate the address format used by IS-IS. In this example, the first five bytes (47.0005.0001) are the area address. The system portion is 000c.000a.4321 and the last byte is always 0.

Figure 25-1. ISO Address Format

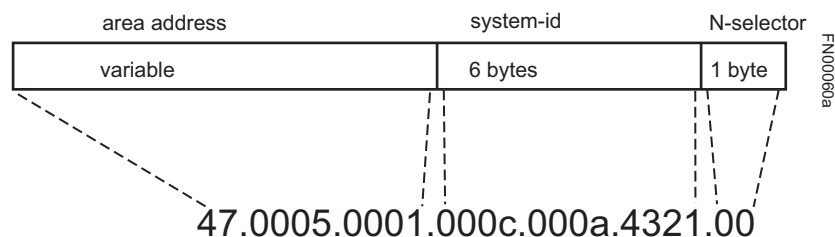

Multi-Topology IS-IS

FTOS 7.8.1.0 and later support Multi-Topology Routing IS-IS.

E-Series ExaScale platform E_{\times} supports Multi-Topology IS-IS with FTOS 8.2.1.0 and later.

S-Series platforms **S4810** and **S4820T** support Multi-Topology IS-IS with FTOS 8.3.10.0 and later.

Multi-Topology IS-IS (MT IS-IS) allows you to create multiple IS-IS topologies on a single router with separate databases. This feature is used to place a virtual physical topology into logical routing domains, which can each support different routing and security policies.

All routers on a LAN or point-to-point must have at least one common supported topology when operating in Multi-Topology IS-IS mode. If IPv4 is the common supported topology between those two routers, adjacency can be formed. All topologies must share the same set of L1-L2 boundaries.

You must implement a wide metric-style globally on the Autonomous System to run Multi-Topology IS-IS for IPv6 because the TLVs used to advertise IPv6 information in link-state packets (LSPs) are defined to use only extended metrics.

The Multi-Topology ID is shown in the first octet of the IS-IS packet. Certain MT topologies are assigned to serve predetermined purposes:

- MT ID #0: Equivalent to the “standard” topology.
- MT ID #1: Reserved for IPv4 in-band management purposes.
- MT ID #2: Reserved for IPv6 routing topology.
- MT ID #3: Reserved for IPv4 multicast routing topology.
- MT ID #4: Reserved for IPv6 multicast routing topology.
- MT ID #5: Reserved for IPv6 in-band management purposes.

Transition Mode

All routers in the area or domain must use the same type of IPv6 support, either single-topology or multi-topology. A router operating in multi-topology mode will not recognize the ability of the single-topology mode router to support IPv6 traffic, which will lead to holes in the IPv6 topology.

While in transition mode, both types of TLVs (single-topology and multi-topology) are sent in LSPs for all configured IPv6 addresses, but the router continues to operate in single-topology mode (that is, the topological restrictions of the single-topology mode remain in effect). Transition mode stops after all routers in the area or domain have been upgraded to support multi-topology IPv6. Once all routers in the area or domain are operating in multi-topology IPv6 mode, the topological restrictions of single-topology mode are no longer in effect.

Interface support

MT IS-IS is supported on physical Ethernet interfaces, physical Sonet interfaces, port-channel interfaces (static & dynamic using LACP), and VLAN interfaces.

Adjacencies

Adjacencies on point-to-point interfaces are formed as usual, where IS-IS routers do not implement Multi-Topology (MT) extensions. If a local router does not participate in certain MTs, it will not advertise those MT IDs in its IIHs and so will not include that neighbor within its LSPs. If an MT ID is not detected in the remote side's IIHs, the local router does not include that neighbor within its LSPs. The local router will not form an adjacency if both routers don't have at least one common MT over the interface.

Graceful Restart

Graceful Restart is supported on the  and  and  platforms for both Helper and Restart modes.

Graceful Restart is a protocol-based mechanism that preserves the forwarding table of the restarting router and its neighbors for a specified period to minimize the loss of packets. A graceful-restart router does not immediately assume that a neighbor is permanently down and so does not trigger a topology change.

Normally, when an IS-IS router is restarted, temporary disruption of routing occurs due to events in both the restarting router and the neighbors of the restarting router. When a router goes down without a Graceful Restart, there is a potential to lose access to parts of the network due to the necessity of network topology changes.

IS-IS Graceful Restart recognizes the fact that in a modern router, the control plane and data plane are functionally separate. Restarting the control plane functionality (such as the failover of the active RPM to the backup in a redundant configuration) should not necessarily interrupt data packet forwarding. This behavior is supported because the forwarding tables previously computed by an active RPM have been downloaded into the Forwarding Information Base on the line cards (the data plane) and are still resident. For packets that have existing FIB/CAM entries, forwarding between ingress and egress ports can continue uninterrupted while the control plane IS-IS process comes back to full functionality and rebuilds its routing tables.

A new TLV (the Restart TLV) is introduced in the IIH PDUs, indicating that the router supports Graceful Restart.

Timers

Three timers are used to support IS-IS Graceful Restart functionality. Once Graceful Restart is enabled, these timers manage the Graceful Restart process.

- The T1 timer specifies the wait time before unacknowledged restart requests are generated. This is the interval before the system sends a Restart Request (an IIH with RR bit set in Restart TLV) until the CSNP is received from the helping router. The duration can be set to a specific amount of time (seconds) or a number of attempts.
- The T2 timer is the maximum time that the system will wait for LSP database synchronization. This timer applies to the database type (level-1, level-2 or both).
- The T3 timer sets the overall wait time after which the router determines that it has failed to achieve database synchronization (by setting the overload bit in its own LSP). This timer can be based on adjacency settings with the value derived from adjacent routers that are engaged in graceful restart recovery (the minimum of all the Remaining Time values advertised by the neighbors) or by setting a specific amount of time manually.

Implementation Information

IS-IS implementation supports one instance of IS-IS and six areas. The system can be configured as a Level 1 router, a Level 2 router, or a Level 1-2 router. For IPv6, the IPv4 implementation has been expanded to include two new type-length-values (TLV) in the protocol data unit (PDU) that carry information required for IPv6 routing. The new TLVs are *IPv6 Reachability* and *IPv6 Interface Address*. Also, a new IPv6 protocol identifier has also been included in the supported TLVs. The new TLVs use the extended metrics and up/down bit semantics.

Multi-Topology IS-IS adds TLVs:

- The *Multi-Topology TLV* contains one or more Multi-Topology IDs in which the router participates. This TLV is included in IIH and the first fragment of an LSP.
- The *MT Intermediate Systems TLV* appears for every topology a node supports. An MT ID is added to the extended IS reachability TLV type 22.
- The *Multi-Topology Reachable IPv4 Prefixes TLV* appears for each IPv4 announced by an IS for a given MT ID. Its structure is aligned with the extended IS Reachability TLV Type 236 and it adds an MT ID.
- The *Multi-Topology Reachable IPv6 Prefixes TLV* appears for each IPv6 announced by an IS for a given MT ID. Its structure is aligned with the extended IS Reachability TLV Type 236 and add a MT ID.

By default, FTOS supports dynamic hostname exchange to assist with troubleshooting and configuration. By assigning a name to an IS-IS NET address, you can track IS-IS information on that address easier. FTOS does not support ISO CLNS routing; however, the ISO NET format is supported for addressing.

To support IPv6, the Dell Force10 implementation of IS-IS performs the following tasks:

- Advertise IPv6 information in the PDUs
- Process IPv6 information received in the PDUs
- Compute routes to IPv6 destinations
- Download IPv6 routes to RTM for installing in the FIB
- Accept external IPv6 information and advertise this information in the PDUs

Table 25-1 displays the default values for IS-IS.

Table 25-1. IS-IS Default Values

| IS-IS Parameter | Default Value |
|--|---------------------|
| Complete Sequence Number PDU (CSNP) interval | 10 seconds |
| IS-to-IS hello PDU interval | 10 seconds |
| IS-IS interface metric | 10 |
| Metric style | Narrow |
| Designated Router priority | 64 |
| Circuit Type | Level 1 and Level 2 |
| IS Type | Level 1 and Level 2 |
| Equal Cost Multi Paths | 16 |

Configuration Information

To use IS-IS, you must configure and enable IS-IS in two or three modes: CONFIGURATION ROUTER ISIS, CONFIGURATION INTERFACE, and (when configuring for IPv6) ADDRESS-FAMILY mode. Commands in ROUTER ISIS mode configure IS-IS globally, while commands executed in INTERFACE mode enable and configure IS-IS features on that interface only. Commands in the ADDRESS-FAMILY mode are specific to IPv6.

Note that by using the IS-IS routing protocol to exchange IPv6 routing information and to determine destination reachability, you can route IPv6 along with IPv4 while using a single intra-domain routing protocol. The configuration commands allow you to enable and disable IPv6 routing and to configure or remove IPv6 prefixes on links.

Except where identified, the commands discussed in this chapter apply to both IPv4 and IPv6 versions of IS-IS.

Configuration Task List for IS-IS

The following list includes the configuration tasks for IS-IS:

- [Enable IS-IS on page 519](#)
- [Configure Multi-Topology IS-IS \(MT IS-IS\) on page 522](#)
- [Configure IS-IS Graceful Restart on page 523](#)
- [Change LSP attributes on page 526](#)
- [Configure IS-IS metric style and cost on page 527](#)
- [Change the IS-type on page 529](#)
- [Control routing updates on page 530](#)
- [Configure authentication passwords on page 534](#)

- [Set the overload bit on page 535](#)
- [Debug IS-IS on page 536](#)

Enable IS-IS

By default, IS-IS is not enabled.

The system supports one instance of IS-IS. To enable IS-IS globally, create an IS-IS routing process and assign a NET address. To exchange protocol information with neighbors, enable IS-IS on an interface, instead of on a network as with other routing protocols.

In IS-IS, neighbors form adjacencies only when they are same IS type. For example, a Level 1 router never forms an adjacency with a Level 2 router. A Level 1-2 router will form Level 1 adjacencies with a neighboring Level 1 router and will form Level 2 adjacencies with a neighboring Level 2 router.



Note: Even though you enable IS-IS globally, you must enable the IS-IS process on an interface for the IS-IS process to exchange protocol information and form adjacencies.

Use these commands in the following sequence to configure IS-IS globally.

| Step | Task | Command Syntax | Command Mode |
|------|--|--|---------------|
| 1 | Create an IS-IS routing process. <ul style="list-style-type: none"> • <i>tag</i> is optional and identifies the name of the IS-IS process. | router isis [<i>tag</i>] | CONFIGURATION |
| 2 | Configure an IS-IS network entity title (NET) for a routing process. Specify the area address and system ID for an IS-IS routing process. The last byte must be 00. Refer to IS-IS Addressing for more information on configuring a NET. | net <i>network-entity-title</i> | ROUTER ISIS |

| Step | Task | Command Syntax | Command Mode |
|------|--|---|---------------|
| 3 | <p>Enter the interface configuration mode. Enter the keyword interface followed by the type of interface and slot/port information:</p> <ul style="list-style-type: none"> For a 1-Gigabit Ethernet interface, enter the keyword GigabitEthernet followed by the slot/port information. For the Loopback interface on the RPM, enter the keyword loopback followed by a number from 0 to 16383. For a port channel, enter the keyword port-channel followed by a number from 1 to 255 for TeraScale and ExaScale, 1 to 32 for EtherScale. For a SONET interface, enter the keyword sonet followed by slot/port information. For a 10-Gigabit Ethernet interface, enter the keyword TenGigabitEthernet followed by the slot/port information. For a VLAN, enter the keyword vlan followed by a number from 1 to 4094. <p>E-Series ExaScale platforms support 4094 VLANs with FTOS version 8.2.1.0 and later. Earlier ExaScale supports 2094 VLANs.</p> | interface <i>interface</i> | CONFIGURATION |
| 4 | <p>Enter an IPv4 Address. Assign an IP address and mask to the interface. The IP address must be on the same subnet as other IS-IS neighbors, but the IP address does not need to relate to the NET address.</p> | ip address <i>ip-address mask</i> | INTERFACE |
| 5 | <p>Enter an IPv6 Address. <i>ipv6 address</i> : x:x:x:x::x <i>mask</i> : prefix length 0-128 The IPv6 address must be on the same subnet as other IS-IS neighbors, but the IP address does not need to relate to the NET address.</p> | ipv6 address <i>ipv6-address mask</i> | INTERFACE |
| 6 | <p>Enable IS-IS on the IPv4 interface. If you configure a <i>tag</i> variable, it must be the same as the <i>tag</i> variable assigned in step 1.</p> | ip router isis [<i>tag</i>] | ROUTER ISIS |
| 7 | <p>Enable IS-IS on the IPv6 interface. If you configure a <i>tag</i> variable, it must be the same as the <i>tag</i> variable assigned in step 1.</p> | ipv6 router isis [<i>tag</i>] | ROUTER ISIS |

The default IS type is level-1-2. To change the IS type to Level 1 only or Level 2 only, use the **is-type** command in ROUTER ISIS mode.

Enter the **show isis protocol** command in EXEC Privilege mode or the **show config** command in ROUTER ISIS mode to view the IS-IS configuration.

Figure 25-2. Command Example: show isis protocol

```
FTOS#show isis protocol
IS-IS Router: <Null Tag>
  System Id: EEEE.EEEE.EEEE  IS-Type: level-1-2
  Manual area address(es) :
    47.0004.004d.0001
  Routing for area address(es) :
    21.2223.2425.2627.2829.3031.3233
    47.0004.004d.0001
  Interfaces supported by IS-IS:
    Vlan 2
    GigabitEthernet 4/22
    Loopback 0
  Redistributing:
  Distance: 115
  Generate narrow metrics: level-1-2
  Accept narrow metrics:   level-1-2
  Generate wide metrics:   none
  Accept wide metrics:     none
FTOS#
```

Use the **show isis traffic** command in EXEC Privilege mode to view IS-IS protocol statistics.

Figure 25-3. Command Example: show isis traffic



```
FTOS#show isis traffic
IS-IS: Level-1 Hellos (sent/rcvd) : 4272/1538
IS-IS: Level-2 Hellos (sent/rcvd) : 4272/1538
IS-IS: PTP Hellos (sent/rcvd)      : 0/0
IS-IS: Level-1 LSPs sourced (new/refresh) : 0/0
IS-IS: Level-2 LSPs sourced (new/refresh) : 0/0
IS-IS: Level-1 LSPs flooded (sent/rcvd) : 32/19
IS-IS: Level-2 LSPs flooded (sent/rcvd) : 32/17
IS-IS: Level-1 LSPs CSNPs (sent/rcvd) : 1538/0
IS-IS: Level-2 LSPs CSNPs (sent/rcvd) : 1534/0
IS-IS: Level-1 LSPs PSNPs (sent/rcvd) : 0/0
IS-IS: Level-2 LSPs PSNPs (sent/rcvd) : 0/0
IS-IS: Level-1 DR Elections : 2
IS-IS: Level-2 DR Elections : 2
IS-IS: Level-1 SPF Calculations : 29
IS-IS: Level-2 SPF Calculations : 29
IS-IS: LSP checksum errors received : 0
IS-IS: LSP authentication failures : 0
FTOS#
```

You can assign additional NET addresses, but the System ID portion of the NET address must remain the same. FTOS supports up to six area addresses.



Some address considerations are:

- In order to be neighbors, Level 1 routers must be configured with at least one common area address.
- A Level 2 router becomes a neighbor with another Level 2 router regardless of the area address configured. However, if the area addresses are different, the link between the Level 2 routers is only at Level 2.

Configure Multi-Topology IS-IS (MT IS-IS)

| Step | Task | Command Syntax | Command Mode |
|---|---|--|---------------------|
| 1 | <p>Enable Multi-Topology IS-IS for IPv6.</p> <p>Enter the <i>transition</i> keyword to allow an IS-IS IPv6 user to continue to use single-topology mode while upgrading to multi-topology mode. After every router has been configured with the transition keyword, and all the routers are in MT IS-IS IPv6 mode users can remove the transition keyword on each router.</p> | multi-topology [<i>transition</i>] | ROUTER ISIS AF IPV6 |
|  | <p>Note: When transition mode is not enabled, you will not have IPv6 connectivity between routers operating in single-topology mode and routers operating in multi-topology mode.</p> | | |
| 2 | Excluded this router from other router's SPF calculations. | set-overload-bit | ROUTER ISIS AF IPV6 |
| 3 | Set the minimum interval between SPF calculations. | spf-interval [level-1 level-2 interval] [initial_wait_interval] [second_wait_interval] | ROUTER ISIS AF IPV6 |
|  | <p>This command is used for IPv6 route computation <i>only</i> when multi-topology is enabled. If using single-topology mode, use the spf-interval command in CONFIG ROUTER ISIS mode to apply to both IPv4 and IPv6 route computations.</p> | | |
| 4 | <p>Implement a wide metric-style globally.</p> <p>To configure wide or wide transition metric style, the cost can be a between 0 and 16,777,215.</p> | isis ipv6 metric metric-value [level-1 level-2 level-1-2] | ROUTER ISIS AF IPV6 |

Configure Multi-Topology IS-IS (MT IS-IS)

| Step | Task | Command Syntax | Command Mode |
|---|--|---|---------------------|
| 1 | Enable Multi-Topology IS-IS for IPv6. Enter the <i>transition</i> keyword to allow an IS-IS IPv6 user to continue to use single-topology mode while upgrading to multi-topology mode. After every router has been configured with the transition keyword, and all the routers are in MT IS-IS IPv6 mode users can remove the transition keyword on each router. | multi-topology [<i>transition</i>] | ROUTER ISIS AF IPV6 |
|  | Note: When transition mode is not enabled, you will not have IPv6 connectivity between routers operating in single-topology mode and routers operating in multi-topology mode. | | |
| 2 | Excluded this router from other router's SPF calculations. | set-overload-bit | ROUTER ISIS AF IPV6 |
| 3 | Set the minimum interval between SPF calculations. | spf-interval [level-1 level-2 interval] [initial_wait_interval [second_wait_interval]] | ROUTER ISIS AF IPV6 |
|  | This command is used for IPv6 route computation <i>only</i> when multi-topology is enabled. If using single-topology mode, use the spf-interval command in CONFIG ROUTER ISIS mode to apply to both IPv4 and IPv6 route computations. | | |
| 4 | Implement a wide metric-style globally. To configure wide or wide transition metric style, the cost can be a between 0 and 16,777,215. | isis ipv6 metric metric-value [level-1 level-2 level-1-2] | ROUTER ISIS AF IPV6 |

Configure IS-IS Graceful Restart

To enable IS-IS Graceful Restart globally, use the following command in ROUTER-ISIS mode. Additional, optional commands can be implemented to enable the Graceful Restart settings.

| Command Syntax | Command Mode | Purpose |
|---|--------------|---|
| graceful-restart ietf | ROUTER-ISIS | Enable Graceful Restart on ISIS processes |
| graceful-restart interval <i>minutes</i> | ROUTER-ISIS | Configure the period of time during which the Graceful Restart attempt will be prevented. Range: 1-120 minutes Default: 5 minutes |

| Command Syntax | Command Mode | Purpose |
|--|--------------|--|
| graceful-restart restart-wait <i>seconds</i> | ROUTER-ISIS | Enable the Graceful Restart maximum wait time before a restarting peer comes up. Be sure to set the t3 timer to adjacency on the restarting router when implementing this command. Range: 5-120 seconds Default: 30 seconds |
| graceful-restart t1 { <i>interval seconds</i> retry-times <i>value</i> } | ROUTER-ISIS | Configure the time that the Graceful Restart timer T1 defines for a restarting router to use for each interface, as an interval before regenerating Restart Request (an IIH with RR bit set in Restart TLV) after waiting for an acknowledgement. interval : wait time (Range: 5-120, default: 5) retry-times : number of times an unacknowledged restart request will be sent before the restarting router gives up the graceful restart engagement with the neighbor. (Range: 1-10 attempts, default: 1) |
| graceful-restart t2 { level-1 level-2 } <i>seconds</i> | ROUTER-ISIS | Configure the time for Graceful Restart timer T2 that a restarting router will use as the wait time for each database to synchronize. level-1, level-2 : identifies the database instance type to which the wait interval applies. Range: 5-120 seconds Default: 30 seconds |
| graceful-restart t3 { adjacency manual <i>seconds</i> } | ROUTER-ISIS | Configure Graceful Restart timer T3 to set the time used by the restarting router as an overall maximum time to wait for database synchronization to complete. adjacency : the restarting router receives the remaining time value from its peer and adjusts its T3 value accordingly if user has configured this option. manual : allows you to specify a fixed value that the restarting router should use. Range: 50-120 seconds Default: 30 seconds |

Note: If this timer expires before the synchronization has completed, the restarting router sends the overload bit in the LSP. The 'overload' bit is an indication to the receiving router that database synchronization did not complete at the restarting router.

Use the **show isis graceful-restart detail** command in EXEC Privilege mode to view all Graceful Restart related configuration.

Figure 25-4. Command Example: show isis graceful-restart detail

```
FTOS#show isis graceful-restart detail
Configured Timer Value
=====
Graceful Restart      : Enabled
Interval/Blackout time : 1 min
T3 Timer              : Manual
T3 Timeout Value     : 30
T2 Timeout Value     : 30 (level-1), 30 (level-2)
T1 Timeout Value     : 5, retry count: 1
Adjacency wait time  : 30

Operational Timer Value
=====
Current Mode/State   : Normal/RUNNING
T3 Time left         : 0
T2 Time left         : 0 (level-1), 0 (level-2)
Restart ACK rcv count : 0 (level-1), 0 (level-2)
Restart Req rcv count : 0 (level-1), 0 (level-2)
Suppress Adj rcv count : 0 (level-1), 0 (level-2)
Restart CSNP rcv count : 0 (level-1), 0 (level-2)
Database Sync count  : 0 (level-1), 0 (level-2)

Circuit GigabitEthernet 2/10:
  Mode: Normal L1-State:NORMAL, L2-State: NORMAL

  L1: Send/Receive: RR:0/0, RA: 0/0, SA:0/0
      T1 time left: 0, retry count left:0

  L2: Send/Receive: RR:0/0, RA: 0/0, SA:0/0
      T1 time left: 0, retry count left:0
FTOS#
```

Use the **show isis interface** command in EXEC Privilege mode to view all interfaces configured with IS-IS routing along with the defaults.

Figure 25-5. Command Example: show isis interface

```

FTOS#show isis interface G1/34
GigabitEthernet 2/10 is up, line protocol is up
  MTU 1497, Encapsulation SAP
  Routing Protocol: IS-IS
    Circuit Type: Level-1-2
    Interface Index 0x62cc03a, Local circuit ID 1
    Level-1 Metric: 10, Priority: 64, Circuit ID: 0000.0000.000B.01
      Hello Interval: 10, Hello Multiplier: 3, CSNP Interval: 10
    Number of active level-1 adjacencies: 1
    Level-2 Metric: 10, Priority: 64, Circuit ID: 0000.0000.000B.01
      Hello Interval: 10, Hello Multiplier: 3, CSNP Interval: 10
    Number of active level-2 adjacencies: 1
    Next IS-IS LAN Level-1 Hello in 4 seconds
    Next IS-IS LAN Level-2 Hello in 6 seconds
    LSP Interval: 33    Next IS-IS LAN Level-1 Hello in 4 seconds
    Next IS-IS LAN Level-2 Hello in 6 seconds
    LSP Interval: 33
  Restart Capable Neighbors: 2, In Start: 0, In Restart: 0
FTOS#

```

Change LSP attributes

IS-IS routers flood Link state PDUs (LSPs) to exchange routing information. LSP attributes include the generation interval, maximum transmission unit (MTU) or size, and the refresh interval. You can modify the LSP attribute defaults, but it is not necessary.

To change the defaults, use any or all of the following commands in ROUTER ISIS mode:

| Command Syntax | Command Mode | Purpose |
|---|--------------|--|
| isp-gen-interval [level-1 level-2] <i>seconds</i> | ROUTER ISIS | Set interval between LSP generation. <ul style="list-style-type: none"> <i>seconds</i> range: 0 to 120 Default is 5 seconds. Default level is Level 1. |
| isp-mtu <i>size</i> | ROUTER ISIS | Set the LSP size. <ul style="list-style-type: none"> <i>size</i> range: 128 to 9195. Default is 1497. |
| isp-refresh-interval <i>seconds</i> | ROUTER ISIS | Set the LSP refresh interval. <ul style="list-style-type: none"> <i>seconds</i> range: 1 to 65535. Default is 900 seconds. |
| max-isp-lifetime <i>seconds</i> | ROUTER ISIS | Set the maximum time LSPs lifetime. <ul style="list-style-type: none"> <i>seconds</i> range: 1 to 65535 Default is 1200 seconds. |

To view the configuration, use the **show config** command in ROUTER ISIS mode or the **show running-config isis** command in EXEC Privilege mode (Figure 475).

Figure 25-6. Command Example: show running-config isis

```
FTOS#show running-config isis
!
router isis
 lsp-refresh-interval 902
 net 47.0005.0001.000C.000A.4321.00
 net 51.0005.0001.000C.000A.4321.00
FTOS#
```

Configure IS-IS metric style and cost

All IS-IS links or interfaces are associated with a cost that is used in the SPF calculations. The possible cost varies depending on the metric style supported. If you configure narrow, transition or narrow transition metric style, the cost can be a number between 0 and 63. If you configure wide or wide transition metric style, the cost can be a number between 0 and 16,777,215. FTOS supports five different metric styles: narrow, wide, transition, narrow transition, and wide transition.

By default, FTOS generates and receives narrow metric values. Metrics or costs higher than 63 are not supported. To accept or generate routes with a higher metric, you must change the metric style of the IS-IS process. For example, if metric is configured as narrow, and an LSP with wide metrics is received, the route is not installed.

FTOS supports the following IS-IS metric styles:

Table 25-2. Metric Styles

| Metric Style | Characteristics | Cost Range Supported on IS-IS Interfaces |
|-------------------|---|--|
| narrow | Sends and accepts narrow or old TLVs (Type Length Value). | 0 to 63 |
| wide | Sends and accepts wide or new TLVs | 0 to 16777215 |
| transition | Sends both wide (new) and narrow (old) TLVs. | 0 to 63 |
| narrow transition | Sends narrow (old) TLVs and accepts both narrow (old) and wide (new) TLVs | 0 to 63 |
| wide transition | Sends wide (new) TLVs and accepts both narrow (old) and wide (new) TLVs. | 0 to 16777215 |

Use the following command in ROUTER ISIS mode to change the IS-IS metric style of the IS-IS process.

| Command Syntax | Command Mode | Purpose |
|--|--------------|--|
| metric-style {narrow [transition] transition wide [transition]} [level-1 level-2] | ROUTER ISIS | Set the metric style for the IS-IS process. Default: narrow Default: Level 1 and Level 2 (level-1-2) |

Use the **show isis protocol** command (Figure 476) in EXEC Privilege mode to view which metric types are generated and received.

Figure 25-7. Command Example: show isis protocol

```

FTOS#show isis protocol
IS-IS Router: <Null Tag>
  System Id: EEEE.EEEE.EEEE  IS-Type: level-1-2
  Manual area address(es):
    47.0004.004d.0001
  Routing for area address(es):
    21.2223.2425.2627.2829.3031.3233
    47.0004.004d.0001
  Interfaces supported by IS-IS:
    Vlan 2
    GigabitEthernet 4/22
    Loopback 0
  Redistributing:
  Distance: 115
  Generate narrow metrics: level-1-2
  Accept narrow metrics:  level-1-2
  Generate wide metrics:  none
  Accept wide metrics:    none
FTOS#

```

← IS-IS metrics settings

When you change from one IS-IS metric style to another, the IS-IS metric value could be affected. For each interface with IS-IS enabled, you can assign a cost or metric that is used in the link state calculation.

Use the following command in INTERFACE mode to change the metric or cost of the interface.

| Command Syntax | Command Mode | Purpose |
|---|--------------|--|
| isis metric <i>default-metric</i> [level-1 level-2] | INTERFACE | <i>default-value</i> range: 0 to 63 if the metric-style is narrow, narrow-transition or transition. 0 to 16777215 if the metric style is wide or wide transition. Default: 10. |
| isis ipv6 metric <i>default-metric</i> [level-1 level-2] | INTERFACE | Assign a metric for an IPv6 link or interface. <ul style="list-style-type: none"> <i>default-metric</i> range: 0 to 63 for narrow and transition metric styles; 0 to 16777215 for wide metric styles. Default is 10. Default level is level-1. Refer to Configure IS-IS metric style and cost for more information on this command. |

Use the **show config** command in INTERFACE mode or the **show isis interface** command in EXEC Privilege mode to view the interface's current metric.

Table 25-3. Correct Value Range for the isis metric command

| Metric Style | Correct Value Range |
|-----------------|---------------------|
| wide | 0 to 16777215 |
| narrow | 0 to 63 |
| wide transition | 0 to 16777215 |

Table 25-3. Correct Value Range for the isis metric command

| Metric Style | Correct Value Range |
|-------------------|---------------------|
| narrow transition | 0 to 63 |
| transition | 0 to 63 |

Configuring the distance of a route

Configure the distance for a route using the **distance** command from ROUTER ISIS mode.

Change the IS-type

You can configure the system to act as one of the following:

- Level 1 router
- Level 1-2 router
- Level 2 router

Use the following command in ROUTER ISIS mode to change the IS-type for the router, u

| Command Syntax | Command Mode | Purpose |
|---|--------------|---|
| is-type {level-1 level-1-2 level-2-only} | ROUTER ISIS | Configure IS-IS operating level for a router. Default is level-1-2. |

| Command Syntax | Command Mode | Purpose |
|--|--------------|---|
| is-type {level-1 level-1-2 level-2} | ROUTER ISIS | Change the IS-type for the IS-IS process. |

Use the **show isis protocol** command in EXEC Privilege mode (Figure 476) to view which IS-type is configured. The **show config** command in ROUTER ISIS mode displays only non-default information, so if you do not change the IS-type, the default value (level-1-2) is not displayed.

The default is Level 1-2 router. When the IS-type is Level 1-2, the software maintains two Link State databases, one for each level. Use the **show isis database** command to view the Link State databases (Figure 477).

Figure 25-8. Command Example: show isis database

```

FTOS#show isis database
IS-IS Level-1 Link State Database
LSPID                LSP Seq Num  LSP Checksum  LSP Holdtime  ATT/P/OL
B233.00-00           0x00000003   0x07BF        1088           0/0/0
eljefe.00-00        * 0x00000009   0xF76A        1126           0/0/0
eljefe.01-00        * 0x00000001   0x68DF        1122           0/0/0
eljefe.02-00        * 0x00000001   0x2E7F        1113           0/0/0
Force10.00-00       0x00000002   0xD1A7        1102           0/0/0
IS-IS Level-2 Link State Database
LSPID                LSP Seq Num  LSP Checksum  LSP Holdtime  ATT/P/OL
B233.00-00           0x00000006   0xC38A        1124           0/0/0
eljefe.00-00        * 0x0000000D   0x51C6        1129           0/0/0
eljefe.01-00        * 0x00000001   0x68DF        1122           0/0/0
eljefe.02-00        * 0x00000001   0x2E7F        1113           0/0/0
Force10.00-00       0x00000004   0xCDA9        1107           0/0/0

FTOS#

```

Control routing updates

Use the following commands in ROUTER ISIS mode to control the source of IS-IS route information.

| Command Syntax | Command Mode | Purpose |
|------------------------------------|--------------|--|
| passive-interface interface | ROUTER ISIS | <p>Disable a specific interface from sending or receiving IS-IS routing information.</p> <p>Enter the type of interface and slot/port information:</p> <ul style="list-style-type: none"> For a 1-Gigabit Ethernet interface, enter the keyword GigabitEthernet followed by the slot/port information. For the Loopback interface on the RPM, enter the keyword loopback followed by a number from 0 to 16383. For a port channel, enter the keyword port-channel followed by a number from 1 to 255 for TeraScale and ExaScale, 1 to 32 for EtherScale. For a SONET interface, enter the keyword sonet followed by slot/port information. For a 10-Gigabit Ethernet interface, enter the keyword TenGigabitEthernet followed by the slot/port information. For a VLAN, enter the keyword vlan followed by a number from 1 to 4094. <p>E-Series ExaScale platforms support 4094 VLANs with FTOS version 8.2.1.0 and later. Earlier ExaScale supports 2094 VLANS.</p> |

Distribute Routes

Another method of controlling routing information is to filter the information through a prefix list. Prefix lists are applied to incoming or outgoing routes and routes must meet the conditions of the prefix lists or FTOS does not install the route in the routing table. The prefix lists are globally applied on all interfaces running IS-IS.

Configure the prefix list in the PREFIX LIST mode prior to assigning it to the IS-IS process. For configuration information on prefix lists, see [Chapter 7, Access Control Lists \(ACLs\)](#).

IPv4 routes

Use the following commands in ROUTER ISIS mode to apply prefix lists to incoming or outgoing IPv4 routes.



Note: These commands apply to IPv4 IS-IS only. Use the ADDRESS-FAMILY IPV6 mode shown later to apply prefix lists to IPv6 routes

| Command Syntax | Command Mode | Purpose |
|---|--------------|--|
| distribute-list <i>prefix-list-name</i> in [<i>interface</i>] | ROUTER ISIS | <p>Apply a configured prefix list to all incoming IPv4 IS-IS routes.</p> <p>Enter the type of interface and slot/port information:</p> <ul style="list-style-type: none"> For a 1-Gigabit Ethernet interface, enter the keyword GigabitEthernet followed by the slot/port information. For the Loopback interface on the RPM, enter the keyword loopback followed by a number from 0 to 16383. For a port channel, enter the keyword port-channel followed by a number from 1 to 255 for TeraScale and ExaScale, 1 to 32 for EtherScale. For a SONET interface, enter the keyword sonet followed by slot/port information. For a 10-Gigabit Ethernet interface, enter the keyword TenGigabitEthernet followed by the slot/port information. For a VLAN, enter the keyword vlan followed by a number from 1 to 4094. <p>E-Series ExaScale platforms support 4094 VLANs with FTOS version 8.2.1.0 and later. Earlier ExaScale supports 2094 VLANs.</p> |
| distribute-list <i>prefix-list-name</i> out [bgp <i>as-number</i> connected ospf <i>process-id</i> rip static] | ROUTER ISIS | <p>Apply a configured prefix list to all outgoing IPv4 IS-IS routes. You can configure one of the optional parameters:</p> <ul style="list-style-type: none"> connected: for directly connected routes. ospf process-id: for OSPF routes only. rip: for RIP routes only. static: for user-configured routes. bgp: for BGP routes only |
| distribute-list redistributed-override in | ROUTER ISIS | Deny RTM download for pre-existing redistributed IPv4 routes |

IPv6 routes

Use these commands in ADDRESS-FAMILY IPV6 mode to apply prefix lists to incoming or outgoing IPv6 routes. =



Note: These commands apply to IPv6 IS-IS only. Use the ROUTER ISIS mode previously shown to apply prefix lists to IPv4 routes.

| Command Syntax | Command Mode | Purpose |
|---|------------------------|---|
| distribute-list <i>prefix-list-name</i> in [<i>interface</i>] | ROUTER ISIS-AF IPV6 | Apply a configured prefix list to all incoming IPv6 IS-IS routes. Enter the type of interface and slot/port information: <ul style="list-style-type: none"> For a 1-Gigabit Ethernet interface, enter the keyword GigabitEthernet followed by the slot/port information. For the Loopback interface on the RPM, enter the keyword loopback followed by a number from 0 to 16383. For a port channel, enter the keyword port-channel followed by a number from 1 to 255 for TeraScale, 1 to 32 for EtherScale. For a SONET interface, enter the keyword sonet followed by slot/port information. For a 10-Gigabit Ethernet interface, enter the keyword TenGigabitEthernet followed by the slot/port information. For a VLAN, enter the keyword vlan followed by a number from 1 to 4094. E-Series ExaScale platforms support 4094 VLANs with FTOS version 8.2.1.0 and later. Earlier ExaScale supports 2094 VLANs. |
| distribute-list <i>prefix-list-name</i> out [bgp <i>as-number</i> connected ospf <i>process-id</i> rip static] | ROUTER ISIS-AF IPV6 | Apply a configured prefix list to all outgoing IPv6 IS-IS routes. You can configure one of the optional parameters: <ul style="list-style-type: none"> connected: for directly connected routes. ospf process-id: for OSPF routes only. rip: for RIP routes only. static: for user-configured routes. bgp: for BGP routes only |
| distribute-list redistributed-override in | ROUTER ISIS-AF IPV6 | Deny RTM download for pre-existing redistributed IPv6 routes |

Redistribute routes

In addition to filtering routes, you can add routes from other routing instances or protocols to the IS-IS process. With the **redistribute** command syntax, you can include BGP, OSPF, RIP, static, or directly connected routes in the IS-IS process.



Note: Do not route iBGP routes to IS-IS unless there are route-maps associated with the IS-IS redistribution.

IPv4 routes

Use any of the following commands in ROUTER ISIS mode to add routes from other routing instances or protocols.



Note: These commands apply to IPv4 IS-IS only. Use the ADDRESS-FAMILY IPV6 mode shown later to apply prefix lists to IPv6 routes.

| Command Syntax | Command Mode | Purpose |
|---|--------------|--|
| redistribute { bgp <i>as-number</i> connected rip static } [level-1 level-1-2 level-2] [metric <i>metric-value</i>] [metric-type { external internal }] [route-map <i>map-name</i>] | ROUTER ISIS | Include BGP, directly connected, RIP, or user-configured (static) routes in IS-IS. Configure the following parameters: <ul style="list-style-type: none">• level-1, level-1-2, or level-2: Assign all redistributed routes to a level. Default is level-2.• <i>metric</i> range: 0 to 16777215. Default is 0.• metric-type: choose either external or internal. Default is internal.• <i>map-name</i>: name of a configured route map. |
| redistribute ospf <i>process-id</i> [level-1 level-1-2 level-2] [metric <i>value</i>] [match external { 1 2 } match internal] [metric-type { external internal }] [route-map <i>map-name</i>] | ROUTER ISIS | Include specific OSPF routes in IS-IS. Configure the following parameters: <ul style="list-style-type: none">• <i>process-id</i> range: 1 to 65535• level-1, level-1-2, or level-2:: Assign all redistributed routes to a level. Default is level-2.• <i>metric</i> range: 0 to 16777215. Default is 0.• match external range: 1 or 2• match internal• metric-type: external or internal.• <i>map-name</i>: name of a configured route map. |

IPv6 routes

Use any of the these commands in ROUTER ISIS ADDRESS-FAMILY IPV6 mode to add routes from other routing instances or protocols.



Note: These commands apply to IPv6 IS-IS only. Use the ROUTER ISIS mode previously shown to apply prefix lists to IPv4 routes.

| Command Syntax | Command Mode | Purpose |
|---|--------------|---|
| redistribute { bgp <i>as-number</i> connected rip static } [level-1 level-1-2 level-2] [metric <i>metric-value</i>] [metric-type { external internal }] [route-map <i>map-name</i>] | ROUTER ISIS | Include BGP, directly connected, RIP, or user-configured (static) routes in IS-IS. Configure the following parameters: <ul style="list-style-type: none"> • level-1, level-1-2, or level-2: Assign all redistributed routes to a level. Default is level-2. • <i>metric</i> range: 0 to 16777215. Default is 0. • metric-type: choose either external or internal. Default is internal. • <i>map-name</i>: name of a configured route map. |
| redistribute ospf <i>process-id</i> [level-1 level-1-2 level-2] [metric <i>value</i>] [match external { 1 2 } match internal] [metric-type { external internal }] [route-map <i>map-name</i>] | ROUTER ISIS | Include specific OSPF routes in IS-IS. Configure the following parameters: <ul style="list-style-type: none"> • <i>process-id</i> range: 1 to 65535 • level-1, level-1-2, or level-2: Assign all redistributed routes to a level. Default is level-2. • <i>metric</i> range: 0 to 16777215. Default is 0. • match external range: 1 or 2 • match internal • metric-type: external or internal. • <i>map-name</i>: name of a configured route map. |

Use the **show running-config isis** command in EXEC Privilege mode to view IS-IS configuration globally (including both IPv4 and IPv6 settings), or the **show config** command in ROUTER ISIS mode to view the current IPv4 IS-IS configuration, or the **show config** command in ROUTER ISIS-ADDRESS FAMILY IPV6 mode to view the current IPv6 IS-IS configuration

Configure authentication passwords

You can assign an authentication password for routers in Level 1 and for routers in Level 2. Since Level 1 and Level 2 routers do not communicate with each other, you can assign different passwords for Level 1 routers and for Level 2 routers. If you want the routers in the level to communicate with each other, though, they must be configured with the same password.

Use either or both of the commands in ROUTER ISIS mode to configure a simple text password.

| Command Syntax | Command Mode | Purpose |
|--|--------------|---|
| area-password [hmac-md5] <i>password</i> | ROUTER ISIS | Configure authentication password for an area. FTOS supports HMAC-MD5 authentication. This password is inserted in Level 1 LSPs, Complete SNPs, and Partial SNPs. |
| domain-password [<i>encryption-type</i> hmac-md5] <i>password</i> | ROUTER ISIS | Set the authentication password for a routing domain. FTOS supports both DES and HMAC-MD5 authentication methods. This password is inserted in Level 2 LSPs, Complete SNPs, and Partial SNPs. |

Use the **show config** command in ROUTER ISIS mode or the **show running-config isis** command in EXEC Privilege mode to view the passwords.

Remove a password by using either the **no area-password** or **no domain-password** command in ROUTER ISIS mode.

Set the overload bit

Another use for the overload bit is to prevent other routers from using this router as an intermediate hop in their shortest path first (SPF) calculations. For example, if the IS-IS routing database is out of memory and cannot accept new LSPs, FTOS sets the overload bit and IS-IS traffic continues to transit the system.

Use this command the following command in ROUTER ISIS mode to set the overload bit manually.

| Command Syntax | Command Mode | Purpose |
|-------------------------|--------------|---|
| set-overload-bit | ROUTER ISIS | Set the overload bit in LSPs. This prevents other routers from using it as an intermediate hop in their shortest path first (SPF) calculations. |

Enter **no set-overload-bit** to remove the overload bit.

When the bit is set, a 1 is placed in the OL column in the show isis database command output. In [Figure 25-9](#), the overload bit is set in both the Level-1 and Level-2 database because the IS type for the router is Level-1-2

Figure 25-9. Command Example: show isis database

```

FTOS#show isis database
IS-IS Level-1 Link State Database
LSPID          LSP Seq Num  LSP Checksum  LSP Holdtime  ATT/P/OL
B233.00-00     0x00000003  0x07BF        1074           0/0/0
eljefe.00-00   * 0x0000000A 0xF963        1196           0/0/1
eljefe.01-00   * 0x00000001 0x68DF        1108           0/0/0
eljefe.02-00   * 0x00000001 0x2E7F        1099           0/0/0
Force10.00-00  0x00000002  0xD1A7        1088           0/0/0
IS-IS Level-2 Link State Database
LSPID          LSP Seq Num  LSP Checksum  LSP Holdtime  ATT/P/OL
B233.00-00     0x00000006  0xC38A        1110           0/0/0
eljefe.00-00   * 0x0000000E 0x53BF        1196           0/0/1
eljefe.01-00   * 0x00000001 0x68DF        1108           0/0/0
eljefe.02-00   * 0x00000001 0x2E7F        1099           0/0/0
Force10.00-00  0x00000004  0xCDA9        1093           0/0/0
FTOS#

```

when overload bit is set, 1 is listed in the OL column.

Debug IS-IS

Enter the **debug isis** command in EXEC Privilege mode to debug all IS-IS processes.

Use the following commands for specific IS-IS debugging.

| Command Syntax | Command Mode | Purpose |
|--|----------------|--|
| debug isis | EXEC Privilege | View all IS-IS information. |
| debug isis adj-packets [<i>interface</i>] | EXEC Privilege | View information on all adjacency-related activity (for example, hello packets that are sent and received). To view specific information, enter one of the following optional parameters: <ul style="list-style-type: none"> <i>interface</i>: Enter the type of interface and slot/port information to view IS-IS information on that interface only. |
| debug isis local-updates [<i>interface</i>] | EXEC Privilege | View information about IS-IS local update packets. To view specific information, enter one of the following optional parameters: <ul style="list-style-type: none"> <i>interface</i>: Enter the type of interface and slot/port information to view IS-IS information on that interface only. |
| debug isis snp-packets [<i>interface</i>] | EXEC Privilege | View IS-IS SNP packets, include CSNPs and PSNPs. To view specific information, enter one of the following optional parameters: <ul style="list-style-type: none"> <i>interface</i>: Enter the type of interface and slot/port information to view IS-IS information on that interface only. |
| debug isis spf-triggers | EXEC Privilege | View the events that triggered IS-IS shortest path first (SPF) events for debugging purposes. |

| Command Syntax | Command Mode | Purpose |
|---|----------------|---|
| debug isis update-packets [<i>interface</i>] | EXEC Privilege | View sent and received LSPs. To view specific information, enter one of the following optional parameters: <ul style="list-style-type: none"> <i>interface</i>: Enter the type of interface and slot/port information to view IS-IS information on that interface only. |

FTOS displays debug messages on the console. Use the **show debugging** command in EXEC Privilege mode to view which debugging commands are enabled.

Enter the keyword **no** followed by the debug command to disable a specific debug command. For example, to disable debugging of IS-IS updates, enter **no debug isis updates-packets**.

Enter **no debug isis** to disable all IS-IS debugging.

Enter **undebug all** to disable all debugging.

IS-IS Metric Styles

The following sections provide additional information on IS-IS Metric Styles.

- [IS-IS Metric Styles on page 537](#)
- [Configure Metric Values on page 537](#)

FTOS supports the following IS-IS metric styles:

- narrow (supports only type, length, and value (TLV) up to 63)
- wide (supports TLV up to 16777215)
- transition (supports both narrow and wide and uses a TLV up to 63)
- narrow transition (accepts both narrow and wide and sends only narrow or old-style TLV)
- wide transition (accepts both narrow and wide and sends only wide or new-style TLV)

Configure Metric Values

The following topics are covered in this section:

- [Maximum Values in the Routing Table on page 538](#)
- [Changing the IS-IS Metric Style in One Level Only on page 538](#)
- [Leaking from One Level to Another on page 540](#)

For any level (Level-1, Level-2, or Level-1-2), the value range possible in the **isis metric** command in INTERFACE mode changes depending on the metric style.

Table 25-4. Correct Value Range for the isis metric Command

| Metric Style | Correct Value Range for the isis metric Command |
|-------------------|---|
| wide | 0 to 16777215 |
| narrow | 0 to 63 |
| wide transition | 0 to 16777215 |
| narrow transition | 0 to 63 |
| transition | 0 to 63 |

Maximum Values in the Routing Table

IS-IS metric styles support different cost ranges for the route. The cost range for the narrow metric style is 0 to 1023, while all other metric styles support a range of 0 to 0xFE000000.

Changing the IS-IS Metric Style in One Level Only

By default, the IS-IS metric style is narrow. When you change from one IS-IS metric style to another, the IS-IS metric value (configured with the **isis metric** command) could be affected.

In the following scenarios, the IS-type is either Level-1 or Level-2 or Level-1-2 and the metric style changes.

Table 25-5. Metric Value when Metric Style Changes

| Beginning metric style | Final metric style | Resulting IS-IS metric value |
|------------------------|--------------------|--|
| wide | narrow | default value (10) if the original value is greater than 63. A message is sent to the console. |
| wide | transition | truncated value ¹ (the truncated value appears in the LSP only.) The original isis metric value is displayed in the show config and show running-config commands and is used if you change back to transition metric style. |
| wide | narrow transition | default value (10) if the original value is greater than 63. A message is sent to the console. |
| wide | wide transition | original value |
| narrow | wide | original value |
| narrow | transition | original value |
| narrow | narrow transition | original value |
| narrow | wide transition | original value |

Table 25-5. Metric Value when Metric Style Changes (continued)

| Beginning metric style | Final metric style | Resulting IS-IS metric value |
|------------------------|--------------------|---|
| transition | wide | original value |
| transition | narrow | original value |
| transition | narrow transition | original value |
| transition | wide transition | original value |
| narrow transition | wide | original value |
| narrow transition | narrow | original value |
| narrow transition | wide transition | original value |
| narrow transition | transition | original value |
| wide transition | wide | original value |
| wide transition | narrow | default value (10) if the original value is greater than 63. A message is sent to the console. |
| wide transition | narrow transition | default value (10) if the original value is greater than 63. A message is sent to the console. |
| wide transition | transition | truncated value (the truncated value appears in the LSP only.) The original isis metric value is displayed in the show config and show running-config commands and is used if you change back to transition metric style. |

1 a truncated value is a value that is higher than 63, but set back to 63 because the higher value is not supported.

Moving to transition and then to another metric style produces different results (Table 25-6).

Table 25-6. Metric Value when Metric Style Changes Multiple Times

| Beginning metric style | next isis metric style | resulting isis metric value | Next metric style | final isis metric value |
|------------------------|------------------------|-----------------------------|-------------------|---|
| wide | transition | truncated value | wide | original value is recovered |
| wide transition | transition | truncated value | wide transition | original value is recovered |
| wide | transition | truncated value | narrow | default value (10) A message is sent to the logging buffer |
| wide transition | transition | truncated value | narrow transition | default value (10) A message is sent to the logging buffer |

Leaking from One Level to Another

In the following scenarios, each IS-IS level is configured with a different metric style.

Table 25-7. Metric Value with Different Levels Configured with Different Metric Styles

| Level-1 metric style | Level-2 metric style | Resulting isis metric value |
|----------------------|----------------------|-----------------------------|
| narrow | wide | original value |
| narrow | wide transition | original value |
| narrow | narrow transition | original value |
| narrow | transition | original value |
| wide | narrow | truncated value |
| wide | narrow transition | truncated value |
| wide | wide transition | original value |
| wide | transition | truncated value |
| narrow transition | wide | original value |
| narrow transition | narrow | original value |
| narrow transition | wide transition | original value |
| narrow transition | transition | original value |
| transition | wide | original value |
| transition | narrow | original value |
| transition | wide transition | original value |
| transition | narrow transition | original value |
| wide transition | wide | original value |
| wide transition | narrow | truncated value |
| wide transition | narrow transition | truncated value |
| wide transition | transition | truncated value |

Sample Configuration

The following configurations are examples for enabling IPv6 IS-IS. These are not comprehensive directions. They are intended to give you a some guidance with typical configurations.



Note: Only **one** IS-IS process can run on the router, even if both IPv4 and IPv6 routing is being used.

You can copy and paste from these examples to your CLI. Be sure you make the necessary changes to support your own IP Addresses, Interfaces, Names, etc.



Note: Whenever ISIS configuration changes are made, the IS-IS process must be cleared (re-started) using the **clear isis** command. The **clear isis** command must include the tag for the ISIS process. The example below shows the response from the router:

```
FTOS#clear isis *
% ISIS not enabled.
FTOS#clear isis 9999 *
```

[Figure 25-10](#) is a sample configuration for enabling IPv6 IS-IS. [Figure 25-13](#) illustrates the topology created with that CLI configuration.

IPv6 IS-IS routes can be configured in one of the following three different methods:

- **Congruent Topology:** Both IPv4 and IPv6 addresses *must* be configured on the interface. The commands **ip router isis** and **ipv6 router isis** must be enabled on the interface. You must enable the *wide-metrics* parameter in the router isis configuration mode.
- **Multi-topology:** The IPv6 address *must* be configured. Configuring the IPv4 address is optional. The command **ipv6 router isis** *must* be enabled on the interface. If IPv4 is configured, the command **ip router isis** must also be enabled. In the router isis configuration mode, enable multi-topology under address-family ipv6 unicast.
- **Multi-topology Transition:** The IPv6 address *must* be configured. Configuring the IPv4 address is optional. The command **ipv6 router isis** *must* be enabled on the interface. If IPv4 is configured, the command **ip router isis** must also be enabled. In the router isis configuration mode, enable multi-topology transition under address-family ipv6 unicast.

Figure 25-10. IS-IS Sample Configuration - Congruent Topology

```

FTOS(conf-if-te-3/17)#show config
!
interface TenGigabitEthernet 3/17
ip address 24.3.1.1/24
ipv6 address 24:3::1/76
ip router isis
ipv6 router isis
no shutdown
FTOS (conf-if-te-3/17)#

FTOS (conf-router_isis)#show config
!
router isis
metric-style wide level-1
metric-style wide level-2
net 34.0000.0000.AAAA.00
FTOS (conf-router_isis)#

```

Figure 25-11. IS-IS Sample Configuration - Multi-topology

```

FTOS (conf-if-te-3/17)#show config
!
interface TenGigabitEthernet 3/17
ipv6 address 24:3::1/76
ipv6 router isis
no shutdown
FTOS (conf-if-te-3/17)#

FTOS (conf-router_isis)#show config
!
router isis
net 34.0000.0000.AAAA.00
!
address-family ipv6 unicast
multi-topology
exit-address-family
FTOS (conf-router_isis)#

```

Figure 25-12. IS-IS Sample Configuration - Multi-topology Transition

```

FTOS (conf-if-te-3/17)#show config
!
interface TenGigabitEthernet 3/17
ipv6 address 24:3::1/76
ipv6 router isis
no shutdown
FTOS (conf-if-te-3/17)#

FTOS (conf-router_isis)#show config
!
router isis
net 34.0000.0000.AAAA.00
!
address-family ipv6 unicast
multi-topology transition
exit-address-family
FTOS (conf-router_isis)#

```

Figure 25-13. IPv6 IS-IS Sample Topography

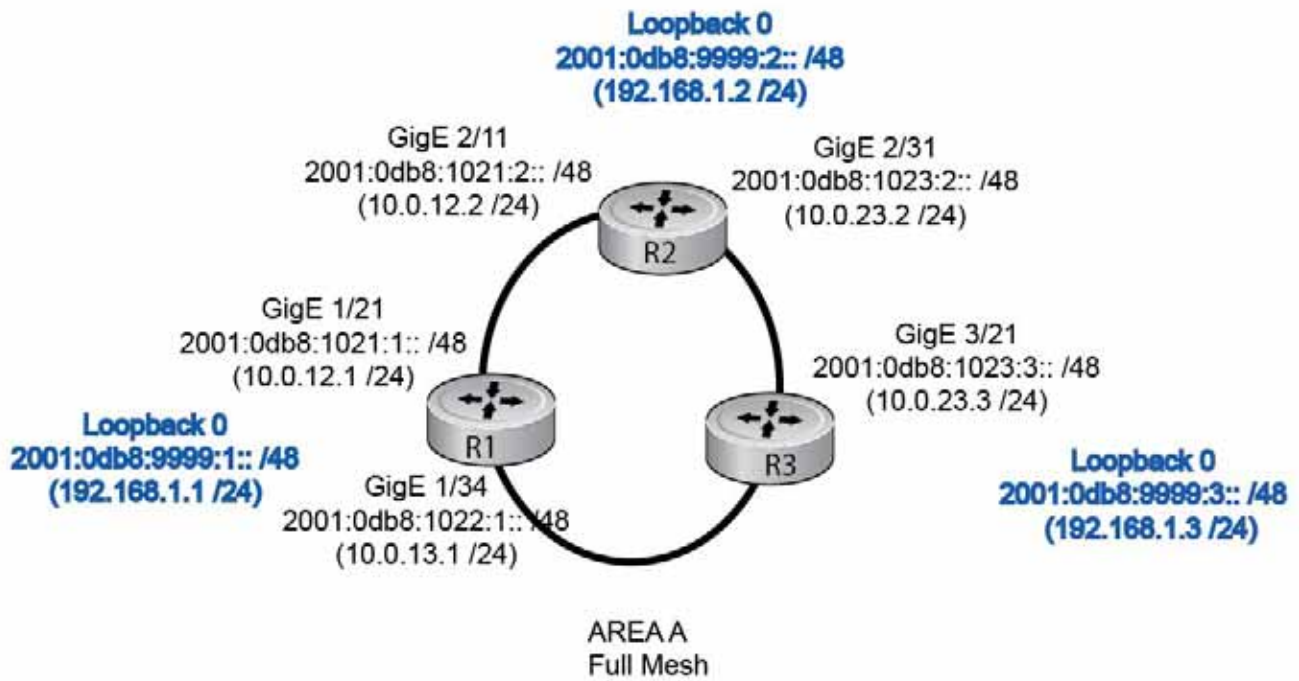

IPv6 Routing

IPv6 Routing is supported on platforms `e c s` **S4810** **S4820T**



Note: The IPv6 basic commands are supported on all platforms. However, not all features are supported on all platforms, nor for all releases. See [Table 26-2](#) to determine the FTOS version supporting which features and platforms.

IPv6 (Internet Protocol Version 6) is the successor to IPv4. Due to the extremely rapid growth in internet users and IP addresses, IPv4 is reaching its maximum usage. IPv6 will eventually replace IPv4 usage to allow for the constant expansion.

This chapter provides a brief discussion of the differences between IPv4 and IPv6, and the Dell Force10 support of IPv6. This chapter discusses the following, but is not intended to be a comprehensive discussion of IPv6.

- [Protocol Overview](#)
 - [Extended Address Space](#)
 - [Stateless Autoconfiguration](#)
 - [IPv6 Headers](#)
- [Implementing IPv6 with FTOS](#)
 - [ICMPv6](#)
 - [Path MTU Discovery](#)
 - [IPv6 Neighbor Discovery](#)
 - [QoS for IPv6](#)
 - [IPv6 Multicast](#)
 - [SSH over an IPv6 Transport](#)
- [Configuration Task List for IPv6](#)

Protocol Overview

IPv6 is an evolution of IPv4. IPv6 is generally installed as an upgrade in devices and operating systems. Most new devices and operating systems support both IPv4 and IPv6.

Some key changes in IPv6 are:

- [Extended Address Space](#)

- Stateless Autoconfiguration
- Header Format Simplification
- Improved Support for Options and Extensions

Extended Address Space

The address format is extended from 32 bits to 128 bits. This not only provides room for all anticipated needs, it allows for the use of a hierarchical address space structure to optimize global addressing.

Stateless Autoconfiguration

When a booting device comes up in IPv6 and asks for its network prefix, the device can get the prefix (or prefixes) from an IPv6 router on its link. It can then autoconfigure one or more global IPv6 addresses by using either the MAC address or a private random number to build its unique IPv6 address.

Stateless auto-configuration uses three mechanisms for IPv6 address configuration:

- Prefix Advertisement - Routers use “Router Advertisement” messages to announce the Network Prefix. Hosts then use their interface-identifier MAC address to generate their own valid IPv6 address.
- Duplicate Address Detection (DAD) - Before configuring its IPv6 address, an IPv6 host node device checks whether that address is used anywhere on the network using this mechanism.
- Prefix Renumbering - Useful in transparent renumbering of hosts in the network when an organization changes its service provider.



Note: As an alternative to stateless auto-configuration, network hosts can obtain their IPv6 addresses using Dynamic Host Control Protocol (DHCP) servers via stateful auto-configuration.



Note: FTOS provides the flexibility to add prefixes to advertise responses to RS messages. By default the RA response messages are not sent when an RS message is received. Enable the RA response messages with the `ipv6 nd prefix default` command in INTERFACE mode.

FTOS manipulation of IPv6 stateless auto-configuration supports the router side only. Neighbor Discovery (ND) messages are advertised so the neighbor can use this information to auto-configure its address. However, received Neighbor Discovery (ND) messages are not used to create an IPv6 address.

The router redirect functionality in Neighbor Discovery Protocol (NDP) is similar to IPv4 router redirect messages. Neighbor Discovery Protocol (NDP) uses ICMPv6 redirect messages (Type 137) to inform nodes that a better router exists on the link.

IPv6 Headers

The IPv6 header has a fixed length of 40 bytes. This provides 16 bytes each for Source and Destination information and 8 bytes for general header information. The IPv6 header includes the following fields:

- [Version \(4 bits\)](#)

- Traffic Class (8 bits)
- Flow Label (20 bits)
- Payload Length (16 bits)
- Next Header (8 bits)
- Hop Limit (8 bits)
- Source Address (128 bits)
- Destination Address (128 bits)

IPv6 provides for Extension Headers. Extension Headers are used only if necessary. There can be no extension headers, one extension header or more than one extension header in an IPv6 packet. Extension Headers are defined in the Next Header field of the preceding IPv6 header.

IPv6 Header Fields

The 40 bytes of the IPv6 header are ordered as show in [Figure 26-1](#).

Figure 26-1. IPv6 Header Fields

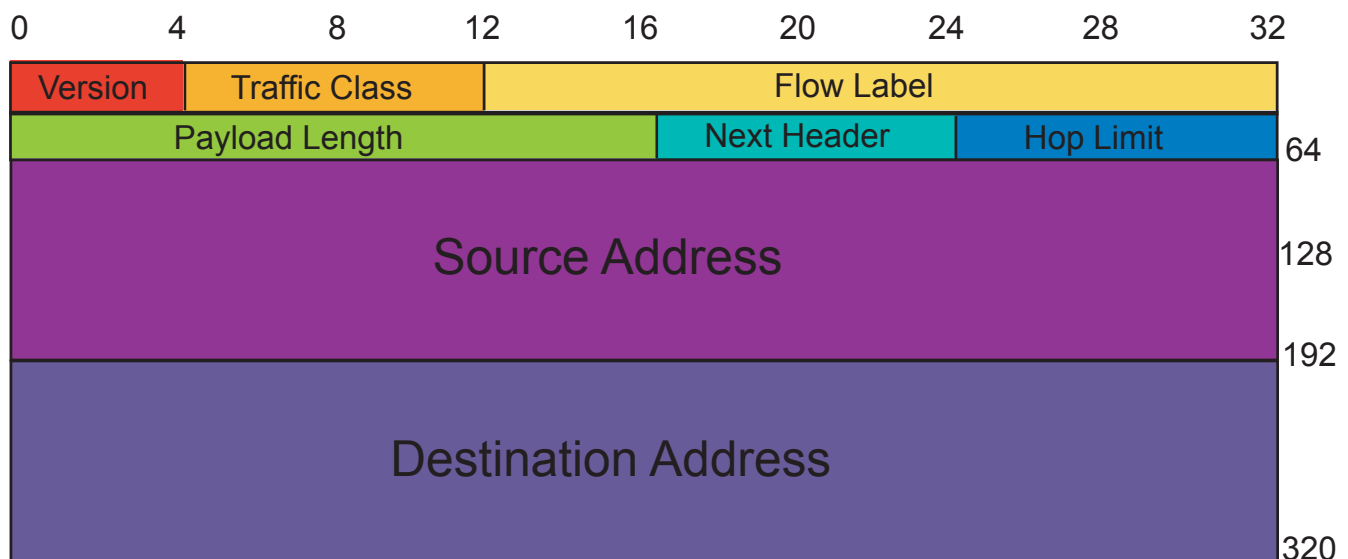

Version (4 bits)

The Version field always contains the number 6, referring to the packet's IP version.

Traffic Class (8 bits)

The Traffic Class field deals with any data that needs special handling. These bits define the packet priority and are defined by the packet Source. Sending and forwarding routers use this field to identify different IPv6 classes and priorities. Routers understand the priority settings and handle them appropriately during conditions of congestion.

Flow Label (20 bits)

The Flow Label field identifies packets requiring special treatment in order to manage real-time data traffic. The sending router can label sequences of IPv6 packets so that forwarding routers can process packets within the same flow without needing to reprocess each packet's header separately.



Note: All packets in the flow must have the same source and destination addresses.

Payload Length (16 bits)

The Payload Length field specifies the packet payload. This is the length of the data *following* the IPv6 header. IPv6 Payload Length only includes the data following the header, not the header itself.

The Payload Length limit of 2 bytes requires that the maximum packet payload be 64 KB. However, the Jumbogram option type Extension header supports larger packet sizes when required.

Next Header (8 bits)

The Next Header field identifies the next header's type. If an Extension header is used, this field contains the type of Extension header (Table 26-1). If the next header is a TCP or UDP header, the value in this field is the same as for IPv4. The Extension header is located between the IP header and the TCP or UDP header.

Table 26-1. Next Header field values

| Value | Description |
|-------|---------------------------------|
| 0 | Hop-by-Hop option header |
| 4 | IPv4 |
| 6 | TCP |
| 8 | Exterior Gateway Protocol (EGP) |
| 41 | IPv6 |
| 43 | Routing header |
| 44 | Fragmentation header |
| 50 | Encrypted Security |
| 51 | Authentication header |
| 59 | No Next Header |
| 60 | Destinations option header |



Note: This is not a comprehensive table of Next Header field values. Refer to the Internet Assigned Numbers Authority (IANA) web page at <http://www.iana.org/assignments/protocol-numbers> for a complete and current listing.

Hop Limit (8 bits)

The Hop Limit field shows the number of hops remaining for packet processing. In IPv4, this is known as the Time to Live (TTL) field and uses seconds rather than hops.

Each time the packet moves through a forwarding router, this field decrements by 1. If a router receives a packet with a Hop Limit of 1, it decrements it to 0 (zero). The router discards the packet and sends an ICMPv6 message back to the sending router indicating that the Hop Limit was exceeded in transit.

Source Address (128 bits)

The Source Address field contains the IPv6 address for the packet originator.

Destination Address (128 bits)

The Destination Address field contains the intended recipient's IPv6 address. This can be either the ultimate destination or the address of the next hop router.

Extension Header fields

Extension headers are used only when necessary. Due to the streamlined nature of the IPv6 header, adding extension headers do not severely impact performance. Each Extension headers's lengths vary, but they are always a multiple of 8 bytes.

Each extension header is identified by the Next Header field in the IPv6 header that precedes it. Extension headers are viewed only by the destination router identified in the Destination Address field. If the Destination Address is a multicast address, the Extension headers are examined by all the routers in that multicast group.

However, if the Destination Address is a Hop-by-Hop options header, the Extension header is examined by every forwarding router along the packet's route. The Hop-by-Hop options header must immediately follow the IPv6 header, and is noted by the value 0 (zero) in the Next Header field ([Table 26-1](#)).

Extension headers are processed in the order in which they appear in the packet header.

Hop-by-Hop Options header

The Hop-by-Hop options header contains information that is examined by every router along the packet's path. It follows the IPv6 header and is designated by the Next Header value 0 (zero) ([Table 26-1](#)).

When a Hop-by-Hop Options header is not included, the router knows that it does not have to process any router specific information and immediately processes the packet to its final destination.

When a Hop-by-Hop Options header is present, the router only needs this extension header and does not need to take the time to view further into the packet.

The Hop-by-Hop Options header contains:

- Next Header (1 byte)

This field identifies the type of header following the Hop-by-Hop Options header and uses the same values shown in [Table 26-1](#).

- Header Extension Length (1 byte)

This field identifies the length of the Hop-by-Hop Options header in 8-byte units, but does not include the first 8 bytes. Consequently, if the header is less than 8 bytes, the value is 0 (zero).

- Options (size varies)

This field can contain 1 or more options. The first byte of the field identifies the Option type, and directs the router how to handle the option.

| | |
|----|--|
| 00 | Skip and continue processing |
| 01 | Discard the packet. |
| 10 | Discard the packet and send an ICMP Parameter Problem Code 2 message to the packet's Source IP Address identifying the unknown option type |
| 11 | Discard the packet and send an ICMP Parameter Problem, Code 2 message to the packet's Source IP Address only if the Destination IP Address is not a multicast address. |

The second byte contains the Option Data Length.

The third byte specifies whether the information can change en route to the destination. The value is 1 if it can change; the value is 0 if it cannot change.

Addressing

IPv6 addresses are normally written as eight groups of four hexadecimal digits, where each group is separated by a colon (:). For example, 2001:0db8:0000:0000:0000:0000:1428:57ab is a valid IPv6 address. If one or more four-digit group(s) is 0000, the zeros may be omitted and replaced with two colons (::). For example, 2001:0db8:0000:0000:0000:0000:1428:57ab can be shortened to 2001:0db8::1428:57ab. Only one set of double colons is supported in a single address. Any number of consecutive 0000 groups may be reduced to two colons, as long as there is *only one double colon used in an address*. Leading and/or trailing zeros in a group can also be omitted (as in ::1 for localhost, 1:: for network addresses and :: for unspecified addresses).

All the addresses in the following list are all valid and equivalent.

- 2001:0db8:0000:0000:0000:0000:1428:57ab
- 2001:0db8:0000:0000:0000::1428:57ab
- 2001:0db8:0:0:0:0:1428:57ab
- 2001:0db8:0:0::1428:57ab

- 2001:0db8::1428:57ab
- 2001:db8::1428:57ab

IPv6 networks are written using Classless Inter-Domain Routing (CIDR) notation. An IPv6 network (or subnet) is a contiguous group of IPv6 addresses the size of which must be a power of two; the initial bits of addresses, which are identical for all hosts in the network, are called the network's prefix.

A network is denoted by the first address in the network and the size in bits of the prefix (in decimal), separated with a slash. Since a single host is seen as a network with a 128-bit prefix, host addresses may be written with a following /128.

For example, 2001:0db8:1234::/48 stands for the network with addresses 2001:0db8:1234:0000:0000:0000:0000 through 2001:0db8:1234:ffff:ffff:ffff:ffff:ffff

Link-local Addresses

Link-local addresses, starting with **fe80:**, are assigned only in the local link area. The addresses are generated usually automatically by the operating system's IP layer for each network interface. This provides instant automatic network connectivity for any IPv6 host and means that if several hosts connect to a common hub or switch, they have an instant communication path via their link-local IPv6 address.

Link-local addresses cannot be routed to the public Internet.

Static and Dynamic Addressing

Static IPv6 addresses are manually assigned to a computer by an administrator. Dynamic IPv6 addresses are assigned either randomly or by a server using Dynamic Host Configuration Protocol (DHCP). Even though IPv6 addresses assigned using DHCP may stay the same for long periods of time, they can change. In some cases, a network administrator may implement dynamically assigned static IPv6 addresses. In this case, a DHCP server is used, but it is specifically configured to always assign the same IPv6 address to a particular computer, and never to assign that IP address to another computer. This allows static IPv6 addresses to be configured in one place, without having to specifically configure each computer on the network in a different way.

In IPv6, every interface, whether using static or dynamic address assignments, also receives a local-link address automatically in the fe80::/64 subnet.

Implementing IPv6 with FTOS

FTOS supports both IPv4 and IPv6 and both may be used simultaneously in your system.



Note: Dell Force10 recommends that you use FTOS version 7.6.1.0 or later when implementing IPv6 functionality on an E-Series system.

Table 26-2 lists the FTOS Version in which an IPv6 feature became available for each platform. The sections following the table give some greater detail about the feature. Specific platform support for each feature or functionality is designated by the following symbols: C E S

Table 26-2. FTOS and IPv6 Feature Support

| Feature and/or Functionality | FTOS Release Introduction | | | | | | Documentation and Chapter Location |
|---------------------------------------|---------------------------|-------------------|----------|----------|----------|----------|--|
| | E-Series TeraScale | E-Series ExaScale | C-Series | S-Series | S4810 | S4820T | |
| Basic IPv6 Commands | 7.4.1 | 8.2.1 | 7.8.1 | 7.8.1 | 8.3.10.0 | 8.3.19.0 | IPv6 Basic Commands in the <i>FTOS Command Line Interface Reference Guide</i> |
| IPv6 Basic Addressing | | | | | | | |
| IPv6 address types: Unicast | 7.4.1 | 8.2.1 | 7.8.1 | 7.8.1 | 8.3.10.0 | 8.3.19.0 | Extended Address Space in this chapter |
| IPv6 neighbor discovery | 7.4.1 | 8.2.1 | 7.8.1 | 7.8.1 | 8.3.10.0 | 8.3.19.0 | IPv6 Neighbor Discovery in this chapter |
| IPv6 stateless autoconfiguration | 7.4.1 | 8.2.1 | 7.8.1 | 7.8.1 | 8.3.10.0 | 8.3.19.0 | Stateless Autoconfiguration in this chapter |
| IPv6 MTU path discovery | 7.4.1 | 8.2.1 | 7.8.1 | 7.8.1 | 8.3.10.0 | 8.3.19.0 | Path MTU Discovery in this chapter |
| IPv6 ICMPv6 | 7.4.1 | 8.2.1 | 7.8.1 | 7.8.1 | 8.3.10.0 | 8.3.19.0 | ICMPv6 in this chapter |
| IPv6 ping | 7.4.1 | 8.2.1 | 7.8.1 | 7.8.1 | 8.3.10.0 | 8.3.19.0 | ICMPv6 in this chapter |
| IPv6 traceroute | 7.4.1 | 8.2.1 | 7.8.1 | 7.8.1 | 8.3.10.0 | 8.3.19.0 | ICMPv6 in this chapter |
| IPv6 Routing | | | | | | | |
| Static routing | 7.4.1 | 8.2.1 | 7.8.1 | 7.8.1 | 8.3.10.0 | 8.3.19.0 | Assign a Static IPv6 Route in this chapter |
| Route redistribution | 7.4.1 | 8.2.1 | 7.8.1 | 8.4.2 | 8.3.10.0 | 8.3.19.0 | OSPF, IS-IS, and IPv6 BGP chapters in the <i>FTOS Command Line Reference Guide</i> |
| Multiprotocol BGP extensions for IPv6 | 7.4.1 | 8.2.1 | 7.8.1 | 8.4.2 | 8.3.10.0 | 8.3.19.0 | IPv6 BGP in the <i>FTOS Command Line Reference Guide</i> |
| IPv6 BGP MD5 Authentication | 8.2.1.0 | 8.2.1.0 | 8.2.1.0 | 8.4.2 | 8.3.10.0 | 8.3.19.0 | IPv6 BGP in the <i>FTOS Command Line Reference Guide</i> |
| IS-IS for IPv6 | N/A | N/A | N/A | N/A | 8.3.10.0 | 8.3.19.0 | Chapter 25, “Intermediate System to Intermediate System,” on page 513 in the <i>FTOS Configuration Guide</i> IPv6 IS-IS in the <i>FTOS Command Line Reference Guide</i> |

Table 26-2. FTOS and IPv6 Feature Support (continued)

| | | | | | | | |
|---|-------|-------|-------|---------|----------|----------|--|
| IS-IS for IPv6 support for redistribution | N/A | N/A | N/A | N/A | 8.3.10.0 | 8.3.19.0 | Chapter 25, “Intermediate System to Intermediate System,” on page 513 in the <i>FTOS Configuration Guide</i> IPv6 IS-IS in the <i>FTOS Command Line Reference Guide</i> |
| ISIS for IPv6 support for distribute lists and administrative distance | N/A | N/A | N/A | N/A | 8.3.10.0 | 8.3.19.0 | Chapter 25, “Intermediate System to Intermediate System,” on page 513 in the <i>FTOS Configuration Guide</i> IPv6 IS-IS in the <i>FTOS Command Line Reference Guide</i> |
| OSPF for IPv6 (OSPFv3) | N/A | N/A | N/A | N/A | N/A | N/A | OSPFv3 in the <i>FTOS Command Line Reference Guide</i> |
| Equal Cost Multipath for IPv6 | 7.4.1 | 8.2.1 | 7.8.1 | 7.8.1 | 8.3.10.0 | 8.3.19.0 | |
| IPv6 Services and Management | | | | | | | |
| Telnet client over IPv6 (outbound Telnet) | 7.5.1 | 8.2.1 | 7.8.1 | 7.8.1 | 8.3.10.0 | 8.3.19.0 | Telnet with IPv6 in this chapter Control and Monitoring in the <i>FTOS Command Line Reference Guide</i> |
| Telnet server over IPv6 (inbound Telnet) | 7.4.1 | 8.2.1 | 7.8.1 | 7.8.1 | 8.3.10.0 | 8.3.19.0 | Telnet with IPv6 in this chapter Control and Monitoring in the <i>FTOS Command Line Reference Guide</i> |
| Secure Shell (SSH) client support over IPv6 (outbound SSH) Layer 3 only | 7.5.1 | 8.2.1 | 7.8.1 | 7.8.1 | 8.3.10.0 | 8.3.19.0 | SSH over an IPv6 Transport in this chapter |
| Secure Shell (SSH) server support over IPv6 (inbound SSH) Layer 3 only | 7.4.1 | 8.2.1 | 7.8.1 | 7.8.1 | 8.3.10.0 | 8.3.19.0 | SSH over an IPv6 Transport in this chapter |
| IPv6 Access Control Lists | 7.4.1 | 8.2.1 | 7.8.1 | 8.2.1.0 | 8.3.10.0 | 8.3.19.0 | IPv6 Access Control Lists in the <i>FTOS Command Line Reference Guide</i> |
| IPv6 Multicast | | | | | | | |

Table 26-2. FTOS and IPv6 Feature Support (continued)

| | | | | | | | |
|-------------------|---------|---------|-------|-------|-----|-----|--|
| PIM-SM for IPv6 | 7.4.1 | 8.2.1 | 8.4.2 | 8.4.2 | N/A | N/A | IPv6 Multicast in this chapter; IPv6 PIM in the <i>FTOS Command Line Reference Guide</i> |
| PIM-SSM for IPv6 | 7.5.1 | 8.2.1 | 8.4.2 | 8.4.2 | N/A | N/A | IPv6 Multicast in this chapter IPv6 PIM in the <i>FTOS Command Line Reference Guide</i> |
| MLDv1/v2 | 7.4.1 | 8.2.1 | 8.4.2 | 8.4.2 | N/A | N/A | IPv6 Multicast in this chapter Multicast IPv6 in the <i>FTOS Command Line Reference Guide</i> |
| MLDv1 Snooping | 7.4.1 | 8.2.1 | 8.4.2 | 8.4.2 | N/A | N/A | IPv6 Multicast in this chapter Multicast IPv6 in the <i>FTOS Command Line Reference Guide</i> |
| MLDv2 Snooping | 8.3.1.0 | 8.3.1.0 | 8.4.2 | 8.4.2 | N/A | N/A | IPv6 Multicast in this chapter Multicast IPv6 in the <i>FTOS Command Line Reference Guide</i> |
| IPv6 QoS | | | | | | | |
| trust DSCP values | 7.4.1 | 8.2.1 | 8.4.2 | 8.4.2 | N/A | N/A | QoS for IPv6 in this chapter |

ICMPv6

ICMPv6 is supported on platforms **C e S**

ICMP for IPv6 combines the roles of ICMP, IGMP and ARP in IPv4. Like IPv4, it provides functions for reporting delivery and forwarding errors, and provides a simple echo service for troubleshooting. The FTOS implementation of ICMPv6 is based on RFC 2463.

Generally, ICMPv6 uses two message types:

- Error reporting messages indicate when the forwarding or delivery of the packet failed at the destination or intermediate node. These messages include Destination Unreachable, Packet Too Big, Time Exceeded and Parameter Problem messages.
- Informational messages provide diagnostic functions and additional host functions, such as Neighbor Discovery and Multicast Listener Discovery. These messages also include Echo Request and Echo Reply messages.

The FTOS ping and traceroute commands extend to support IPv6 addresses. These commands use ICMPv6 Type-2 messages.

Path MTU Discovery

IPv6 MTU Discovery is supported on platforms C e S

Path MTU (Maximum Transmission Unit) defines the largest packet size that can traverse a transmission path without suffering fragmentation. Path MTU for IPv6 uses ICMPv6 Type-2 messages to discover the largest MTU along the path from source to destination and avoid the need to fragment the packet.

The recommended MTU for IPv6 is 1280. Greater MTU settings increase processing efficiency because each packet carries more data while protocol overheads (headers, for example) or underlying per-packet delays remain fixed.

Figure 26-2. MTU Discovery Path

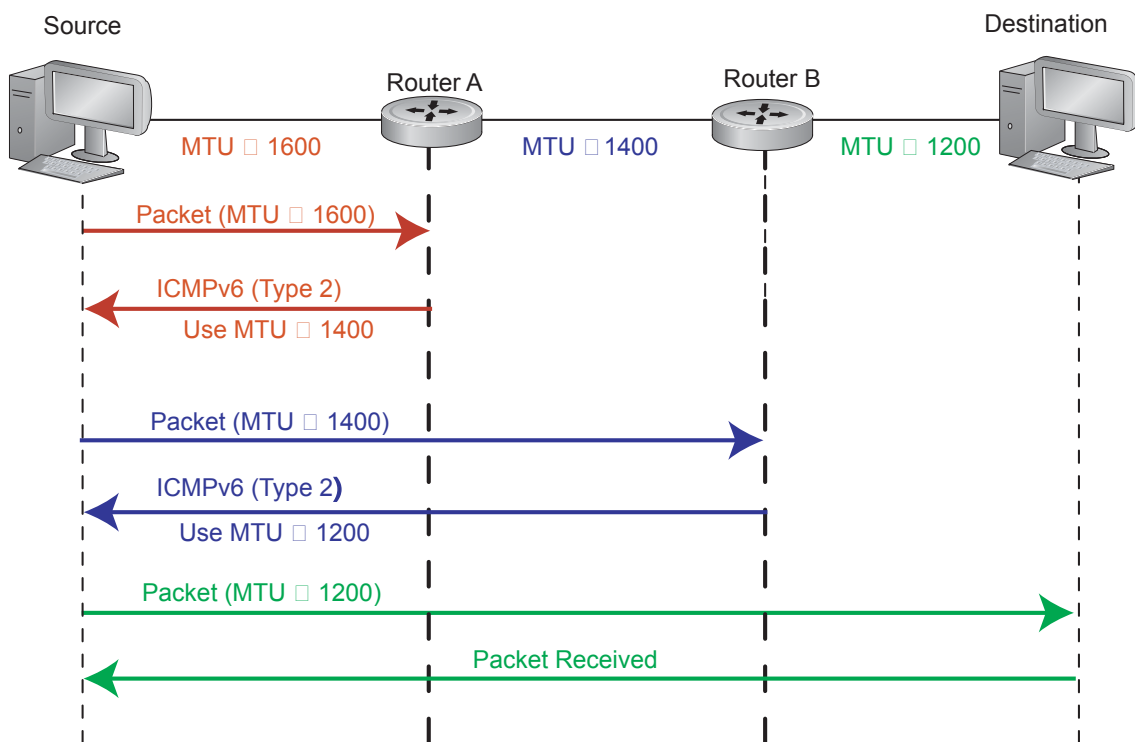

IPv6 Neighbor Discovery

IPv6 NDP is supported on platforms C e S

Neighbor Discovery Protocol (NDP) is a top-level protocol for neighbor discovery on an IPv6 network. In lieu of ARP, NDP uses “Neighbor Solicitation” and “Neighbor Advertisement” ICMPv6 messages for determining relationships between neighboring nodes. Using these messages, an IPv6 device learns the link-layer addresses for neighbors known to reside on attached links, quickly purging cached values that become invalid.



Note: If a neighboring node does not have an IPv6 address assigned, it must be manually pinged to allow the IPv6 device to determine the relationship of the neighboring node.



Note: To avoid problems with network discovery, Dell Force10 recommends configuring the static route last or assigning an IPv6 address to the interface and assigning an address to the peer (the forwarding router’s address) less than 10 seconds apart.

With ARP, each node broadcasts ARP requests on the entire link. This approach causes unnecessary processing by uninterested nodes. With NDP, each node sends a request only to the intended destination via a multicast address with the unicast address used as the last 24 bits. Other hosts on the link do not participate in the process, greatly increasing network bandwidth efficiency.

Figure 26-3. NDP Router Redirect

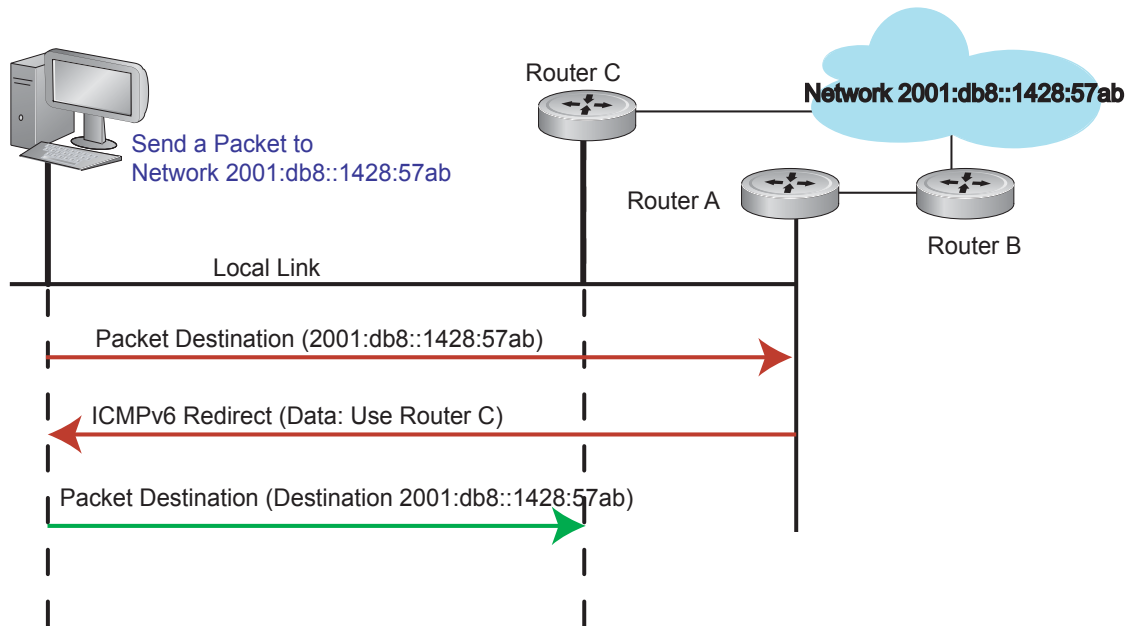

IPv6 Neighbor Discovery of MTU packets

With FTOS 8.3.1.0, you can set the MTU advertised through the RA packets to incoming routers, without altering the actual MTU setting on the interface. The `ipv6 nd mtu` command sets the value advertised to routers. It does not set the actual MTU rate. For example, if `ipv6 nd mtu` is set to 1280, the interface will still pass 1500-byte packets, if that is what is set with the `mtu` command.

QoS for IPv6

IPv6 QoS is supported on platform **E**

FTOS IPv6 supports quality of service based on DSCP field. You can configure FTOS to honor the DSCP value on incoming routed traffic and forward the packets with the same value.

IPv6 Multicast

IPv6 Multicast is supported on platforms **E**

FTOS supports the following protocols to implement IPv6 multicast routing:

- Multicast Listener Discovery Protocol (MLD). MLD on a multicast router sends out periodic general MLD queries that the switch forwards through all ports in the VLAN. There are two versions of MLD: MLD version 1 is based on version 2 of the Internet Group Management Protocol (IGMP) for IPv4; MLD version 2 is based on version 3 of the IGMP for IPv4. IPv6 multicast for FTOS supports versions 1 and 2.
- PIM-SM. Protocol-Independent Multicast-Sparse Mode (PIM-SM) is a multicast protocol in which multicast receivers explicitly join to receive multicast traffic. The protocol uses a router as the root or Rendezvous Point (RP) of the share tree distribution tree to distribute multicast traffic to a multicast group. Messages to join the multicast group (Join messages) are sent towards the RP and data is sent from senders to the RP so receivers can discover who are the senders and begin receiving traffic destined to the multicast group.
- PIM in Source Specific Multicast (PIM-SSM). PIM-SSM protocol is based on the source specific model for forwarding Multicast traffic across multiple domains on the Internet. It is restricted to shortest path trees (SPTs) to specific sources described by hosts using MLD. PIM-SSM is essentially a subset of PIM-SM protocol, which has the capability to join SPTs. The only difference being register states and shared tree states for Multicast groups in SSM range are not maintained. End-hosts use MLD to register their interest in a particular source-group (S,G) pair. PIM-SSM protocol interacts with MLD to construct the multicast forwarding tree rooted at the source S.

Refer to *FTOS Command Line Interface Reference* document chapters Multicast IPv6 and Protocol Independent Multicast (IPv6) for configuration details.

SSH over an IPv6 Transport

IPv6 SSH is supported on platforms **C E S**

FTOS supports both inbound and outbound SSH sessions using IPv6 addressing. Inbound SSH supports accessing the system through the management interface as well as through a physical Layer 3 interface.

Refer to the Security Commands chapter in the *FTOS Command Line Interface Reference* document for SSH configuration details.

Configuration Task List for IPv6

This section contains information regarding the following:

- [Change your CAM-Profile on an E-Series system](#) (mandatory)
- [Adjust your CAM-Profile on a C-Series or S-Series](#)
- [Assign an IPv6 Address to an Interface](#)
- [Assign a Static IPv6 Route](#)
- [Telnet with IPv6](#)
- [SNMP over IPv6](#)
- [Show IPv6 Information](#)
- [Clear IPv6 Routes](#)

Change your CAM-Profile on an E-Series system

The `cam-profile` command is supported only on platform E

Change your CAM profile to the CAM `ipv6-extacl` before doing any further IPv6 configuration. Once the CAM profile is changed, save the configuration and reboot your router.

| Command Syntax | Command Mode | Purpose |
|---|-----------------|--|
| <code>cam-profile ipv6-extacl</code> <code>microcode ipv6-extacl chassis</code> <code>/linecard slot</code> | EXEC Privileged | Enable the CAM profile with IPv6 extended ACLs on the entire chassis or on a specific linecard <i>chassis</i> changes the CAM profile for all linecards in the chassis <i>linecard slot/port</i> changes the CAM profile only for the specified slot |

Figure 26-4 displays the IPv6 CAM profile summary for a chassis that already has IPv6 CAM profile configured. Figure 26-5 shows the full IPv6 CAM profiles. Refer to [Chapter 11, Content Addressable Memory \(CAM\), on page 261](#) for complete information regarding CAM configuration.

Figure 26-4. Command Example: show cam-profile summary (E-Series)

```
FTOS#show cam-profile summary

-- Chassis CAM Profile --
Profile Name       : Current Settings : Next Boot
                   : IPv6-ExtACL       : IPv6-ExtACL
MicroCode Name    : IPv6-ExtACL       : IPv6-ExtACL

-- Line card 1 --
Profile Name       : Current Settings : Next Boot
                   : IPv6-ExtACL       : IPv6-ExtACL
MicroCode Name    : IPv6-ExtACL       : IPv6-ExtACL

FTOS#
```

Figure 26-5. Command Example: show cam-profile (E-Series)

```
FTOS#show cam-profile

-- Chassis CAM Profile --

CamSize          : 18-Meg
                  : Current Settings : Next Boot
Profile Name     : IPV6-ExtACL       : IPV6-ExtACL
L2FIB            : 32K entries       : 32K entries
L2ACL            : 1K entries        : 1K entries
IPV4FIB          : 192K entries      : 192K entries
IPV4ACL          : 12K entries       : 12K entries
IPV4Flow         : 8K entries        : 8K entries
EgL2ACL          : 1K entries        : 1K entries
EgIPV4ACL        : 1K entries        : 1K entries
Reserved         : 2K entries        : 2K entries
IPV6FIB          : 6K entries        : 6K entries
IPV6ACL          : 3K entries        : 3K entries
IPV6Flow         : 4K entries        : 4K entries
EgIPV6ACL        : 1K entries        : 1K entries
MicroCode Name   : IPV6-ExtACL       : IPV6-ExtACL

-- Line card 1 --
CamSize          : 18-Meg
                  : Current Settings : Next Boot

--More--
```

Adjust your CAM-Profile on a C-Series or S-Series

The **cam-acl** command is supported on platforms **C S**

Although this is not a mandatory step, if you plan to implement IPv6 ACLs, you must adjust your CAM settings.

The CAM space is allotted in FP blocks. The total space allocated must equal 13 FP blocks. Note that there are 16 FP blocks, but the System Flow requires 3 blocks that cannot be reallocated.

The **ipv6acl** allocation must be entered as a factor of 2 (2, 4, 6, 8, 10). All other profile allocations can use either even or odd numbered ranges.

The **default** option sets the CAM Profile as follows:

- L3 ACL (ipv4acl): 6
- L2 ACL(l2acl) : 5
- IPv6 L3 ACL (ipv6acl): 0
- L3 QoS (ipv4qos): 1
- L2 QoS (l2qos): 1

Save the new CAM settings to the startup-config (**write-mem** or **copy run start**) then reload the system for the new settings to take effect.

| Command Syntax | Command Mode | Purpose |
|---------------------|------------------------|---|
| cam-acl { ipv6acl } | CONFIGURATION | Allocate space for IPV6 ACLs. Enter the CAM profile name followed by the amount to be allotted. When not selecting the default option, you must enter all of the profiles listed and a range for each. The total space allocated must equal 13. The ipv6acl range must be a factor of 2. |
| show cam-acl | EXEC EXEC Privilege | Show the current CAM settings. |
| show cam-acl-egress | | Provides information on FP groups allocated for the egress acl. You must allocate at least one group for L2ACL and IPv4 ACL. The total number of groups is 4. |

Assign an IPv6 Address to an Interface

IPv6 Addresses are supported on platforms C E S

Essentially IPv6 is enabled in FTOS simply by assigning IPv6 addresses to individual router interfaces. IPv6 and IPv4 can be used together on a system, but be sure to differentiate that usage carefully. Use the **ipv6 address** command to assign an IPv6 address to an interface.

When you configure IPv6 addresses on multiple interfaces (ipv6 address command) and verify the configuration (show ipv6 interfaces command), the same link local (fe80) address is displayed for each IPv6 interface.

| Command Syntax | Command Mode | Purpose |
|---------------------------------------|------------------|--|
| ipv6 address <i>ipv6 address/mask</i> | CONFIG-INTERFACE | Enter the IPv6 Address for the device. <i>ipv6 address</i> : x:x:x::x <i>mask</i> : prefix length 0 to 128 |
| | | IPv6 addresses are normally written as eight groups of four hexadecimal digits, where each group is separated by a colon (:). Omitting zeros is accepted as described in Addressing earlier in this chapter. |

Assign a Static IPv6 Route

IPv6 Static Routes are supported on platforms C e S

Use the `ipv6 route` command to configure IPv6 static routes.

Note: After you configure a static IPv6 route (`ipv6 route` command) and configure the forwarding router's address (specified in the `ipv6 route` command) on a neighbor's interface, the IPv6 neighbor is not displayed in the `show ipv6 route` command output.

| Command Syntax | Command Mode | Purpose |
|---|---------------|---|
| <code>ipv6 route prefix type {slot/port} forwarding router tag</code> | CONFIGURATION | <p>Set up IPv6 static routes</p> <p><i>prefix</i>: IPv6 route prefix</p> <p><i>type {slot/port}</i>: interface type and slot/port</p> <p><i>forwarding router</i>: forwarding router's address</p> <p><i>tag</i>: route tag</p> <p>Enter the keyword interface followed by the type of interface and slot/port information:</p> <ul style="list-style-type: none">• For a 10/100/1000 Ethernet interface, enter the keyword GigabitEthernet followed by the slot/port information.• For a Gigabit Ethernet interface, enter the keyword GigabitEthernet followed by the slot/port information.• For a 10 Gigabit Ethernet interface, enter the keyword TenGigabitEthernet followed by the slot/port information.• For a 40-Gigabit Ethernet interface, enter the keyword fortyGigE followed by the slot/port information.• For a loopback interface, enter the keyword loopback followed by the loopback number• For a linecard interface, enter the keyword linecard followed by the slot number• For a port-channel interface, enter the keyword port-channel followed by the port-channel number• For a VLAN interface, enter the keyword vlan followed by the VLAN ID• For a Null interface, enter the keyword null followed by the Null interface number |

Telnet with IPv6

IPv6 Telnet is supported on platforms C e S

The Telnet client and server in FTOS support IPv6 connections. You can establish a Telnet session directly to the router using an IPv6 Telnet client, or an IPv6 Telnet connection can be initiated from the router.



Note: Telnet to link local addresses is not supported.

| Command Syntax | Command Mode | Purpose |
|--|-----------------------------------|---|
| telnet <i>ipv6 address</i> | EXEC <i>or</i> EXEC Privileged | Enter the IPv6 Address for the device. <i>ipv6 address</i> : x:x:x:x::x <i>mask</i> : prefix length 0-128 |
| IPv6 addresses are normally written as eight groups of four hexadecimal digits, where each group is separated by a colon (:). Omitting zeros is accepted as described in Addressing earlier in this chapter. | | |

SNMP over IPv6

SNMP is supported on platforms C e S

Simple Network Management Protocol (SNMP) can be configured over IPv6 transport so that an IPv6 host can perform SNMP queries and receive SNMP notifications from a device running FTOS IPv6. The FTOS SNMP-server commands for IPv6 have been extended to support IPv6. Refer to the *SNMP and SYSLOG* chapter in the *FTOS Command Line Interface Reference* for more information regarding SNMP commands.

- snmp-server host
- snmp-server user ipv6
- snmp-server community ipv6
- snmp-server community access-list-name ipv6
- snmp-server group ipv6
- snmp-server group access-list-name ipv6

Show IPv6 Information

All of the following show commands are supported on platforms C e S

View specific IPv6 configuration with the following commands.

| Command Syntax | Command Mode | Purpose |
|------------------|-----------------------------------|----------------------------|
| show ipv6 ? | EXEC <i>or</i> EXEC Privileged | List the IPv6 show options |
| FTOS#show ipv6 ? | | |
| accounting | IPv6 accounting information | |
| cam | IPv6 CAM Entries | |
| fib | IPv6 FIB Entries | |
| interface | IPv6 interface information | |
| mbgproutes | MBGP routing table | |
| mld | MLD information | |
| mroute | IPv6 multicast-routing table | |
| neighbors | IPv6 neighbor information | |
| ospf | OSPF information | |
| pim | PIM V6 information | |
| prefix-list | List IPv6 prefix lists | |
| route | IPv6 routing information | |
| rpf | RPF table | |
| FTOS# | | |

Show an IPv6 Interface

View the IPv6 configuration for a specific interface with the following command.

| Command Syntax | Command Mode | Purpose |
|--|--------------|---|
| <code>show ipv6 interface <i>type {slot/port}</i></code> | EXEC | <p>Show the currently running configuration for the specified interface</p> <p>Enter the keyword interface followed by the type of interface and slot/port information:</p> <ul style="list-style-type: none"> • For all brief summary of IPv6 status and configuration, enter the keyword brief. • For all IPv6 configured interfaces, enter the keyword configured. • For a 10/100/1000 Ethernet interface, enter the keyword GigabitEthernet followed by the slot/port information. • For a Gigabit Ethernet interface, enter the keyword GigabitEthernet followed by the slot/port information. • For a 10 Gigabit Ethernet interface, enter the keyword TenGigabitEthernet followed by the slot/port information. • For a 40-Gigabit Ethernet interface, enter the keyword fortyGigE followed by the slot/port information. • For a loopback interface, enter the keyword loopback followed by the loopback number • For a linecard interface, enter the keyword linecard followed by the slot number • For a port-channel interface, enter the keyword port-channel followed by the port-channel number • For a VLAN interface, enter the keyword vlan followed by the VLAN ID |

Figure 26-6 illustrates the show ipv6 interface command output.

Figure 26-6. Command Example: show ipv6 interface

```
FTOS#show ipv6 interface gi 2/2
GigabitEthernet 2/2 is down, line protocol is down
  IPv6 is enabled
  Link Local address: fe80::201:e8ff:fe06:95a3
  Global Unicast address(es):
    3:4:5:6::8, subnet is 3::/24
  Global Anycast address(es):
  Joined Group address(es):
    ff02::1
    ff02::2
    ff02::1:ff00:8
    ff02::1:ff06:95a3
  MTU is 1500
  ICMP redirects are not sent
  DAD is enabled, number of DAD attempts: 1
  ND reachable time is 30 seconds
  ND advertised reachable time is 30 seconds
  ND advertised retransmit interval is 30 seconds
  ND router advertisements are sent every 200 seconds
  ND router advertisements live for 1800 seconds
```

Show IPv6 Routes

View the global IPv6 routing information with the following command.

| Command Syntax | Command Mode | Purpose |
|--|--------------|---|
| <code>show ipv6 route <i>type</i></code> | EXEC | Show IPv6 routing information for the specified route type. Enter the keyword: <ul style="list-style-type: none">To display information about a network, enter the ipv6 address (X:X:X:X::X).To display information about a host, enter the hostname.To display information about all IPv6 routes (including non-active routes), enter all.To display information about all connected IPv6 routes, enter connected.To display information about brief summary of all IPv6 routes, enter summary.To display information about Border Gateway Protocol (BGP) routes, enter bgp.To display information about ISO IS-IS routes, enter isis.To display information about Open Shortest Path First (OSPF) routes, enter ospf.To display information about Routing Information Protocol (RIP), enter rip.To display information about static IPv6 routes, enter static.To display information about an IPv6 Prefix lists, enter list and the prefix-list name. |

Figure 26-7 illustrates the **show ipv6 route** command output.

Figure 26-7. Command Example: show ipv6 route

```
FTOS#show ipv6 route

Codes: C - connected, L - local, S - static, R - RIP,
       B - BGP, IN - internal BGP, EX - external BGP, LO - Locally Originated,
       O - OSPF, IA - OSPF inter area, N1 - OSPF NSSA external type 1,
       N2 - OSPF NSSA external type 2, E1 - OSPF external type 1,
       E2 - OSPF external type 2, i - IS-IS, L1 - IS-IS level-1,
       L2 - IS-IS level-2, IA - IS-IS inter area, * - candidate default,
Gateway of last resort is not set

      Destination  Dist/Metric, Gateway, Last Change
      -----
C      2001::/64 [0/0]
      Direct, Gi 1/1, 00:28:49
C      2002::/120 [0/0]
      Direct, Gi 1/1, 00:28:49
C      2003::/120 [0/0]
      Direct, Gi 1/1, 00:28:49
```

Figure 26-8 illustrates the **show ipv6 route summary** command output.

Figure 26-8. Command Example: show ipv6 route summary

```
FTOS#show ipv6 route summary

Route Source           Active Routes  Non-active Routes
connected              5              0
static                 0              0
Total                  5              0
```

Figure 26-9 illustrates the **show ipv6 route static** command output.

Figure 26-9. Command Example: show ipv6 route static

```
FTOS#show ipv6 route static
Destination Dist/Metric, Gateway, Last Change
-----
S      8888:9999:5555:6666:1111:2222::/96 [1/0]
      via      2222:2222:3333:3333::1, Gi 9/1, 00:03:16
S      9999:9999:9999:9999::/64 [1/0]
      via 8888:9999:5555:6666:1111:2222:3333:4444, 00:03:16
```

Show the Running-Configuration for an Interface

View the configuration for any interface with the following command.

| Command Syntax | Command Mode | Purpose |
|---|--------------|--|
| <code>show running-config</code> <code>interface type {slot/port}</code> | EXEC | Show the currently running configuration for the specified interface Enter the keyword interface followed by the type of interface and slot/port information: <ul style="list-style-type: none">• For a 10/100/1000 Ethernet interface, enter the keyword GigabitEthernet followed by the slot/port information.• For a Gigabit Ethernet interface, enter the keyword GigabitEthernet followed by the slot/port information.• For the Management interface on the RPM, enter the keyword ManagementEthernet followed by the slot/port information.• For a 10 Gigabit Ethernet interface, enter the keyword TenGigabitEthernet followed by the slot/port information.• For a 40-Gigabit Ethernet interface, enter the keyword fortyGigE followed by the slot/port information. |

Figure 26-10 illustrates the show running-config command output. Note the IPv6 address listed.

Figure 26-10. Command Example: show running-config interface

```
FTOS#show run int gi 2/2
!
interface GigabitEthernet 2/2
 no ip address
  ipv6 address 3:4:5:6::8/24
 shutdown
FTOS#
```

Clear IPv6 Routes

Use the clear IPv6 route command to clear routes from the IPv6 routing table.

| Command Syntax | Command Mode | Purpose |
|--|--------------|--|
| <code>clear ipv6 route {* ipv6 address</code> <code>prefix-length}</code> | EXEC | Clear (refresh) all or a specific routes from the IPv6 routing table. * : all routes <i>ipv6 address</i> : x:x:x:x::x <i>mask</i> : prefix length 0-128 |

| Command Syntax | Command Mode | Purpose |
|----------------|--------------|--|
| | | IPv6 addresses are normally written as eight groups of four hexadecimal digits, where each group is separated by a colon (:). Omitting zeros is accepted as described in Addressing earlier in this chapter. |

Link Aggregation Control Protocol (LACP)

Link Aggregation Control Protocol (LACP) is supported on platforms: e C S **S4810**

S4820T

The major sections in the chapter are:

- [Introduction to Dynamic LAGs and LACP](#)
- [LACP Configuration Tasks](#)
- [Shared LAG State Tracking](#)
- [Configure LACP as Hitless](#)
- [LACP Basic Configuration Example](#)

Introduction to Dynamic LAGs and LACP

A *Link Aggregation Group (LAG)*, referred to as a *port channel* by FTOS, can provide both load-sharing and port redundancy across line cards. LAGs can be enabled as static or dynamic. The benefits and constraints are basically the same, as described in [Port Channel Interfaces](#) in the [Interfaces](#) chapter.

The unique benefit of a dynamic LAG is that its ports can toggle between participating in the LAG or acting as dedicated ports, whereas ports in a static LAG must be specifically removed from the LAG in order to act alone.

FTOS uses LACP to create dynamic LAGs. LACP provides a standardized means of exchanging information between two systems (also called Partner Systems) and automatically establishes the LAG between the systems. LACP permits the exchange of messages on a link to allow their LACP instances to:

- Reach agreement on the identity of the LAG to which the link belongs.
- Move the link to that LAG.
- Enable the transmission and reception functions in an orderly manner.

The FTOS implementation of LACP is based on the standards specified in the IEEE 802.3: “Carrier sense multiple access with collision detection (CSMA/CD) access method and physical layer specifications.”

LACP functions by constantly exchanging custom MAC PDUs across LAN Ethernet links. The protocol packets are only exchanged between ports that are configured as LACP capable.

Important Points to Remember

- LACP enables you to add members to a port channel (LAG) as long as it has no static members. Conversely, if the LAG already contains a statically defined member (**channel-member** command), the **port-channel mode** command is not permitted.
- A static LAG cannot be created if a dynamic LAG using the selected number already exists.
- **No dual membership in static and dynamic LAGs:**
 - If a physical interface is a part of a static LAG, then the command **port-channel-protocol lacp** will be rejected on that interface.
 - If a physical interface is a part of a dynamic LAG, it cannot be added as a member of a static LAG. The command **channel-member gigabitethernet x/y** will be rejected in the static LAG interface for that physical interface.
- A dynamic LAG can be created with any type of configuration.
- There is a difference between the **shutdown** and **no interface port-channel**:
 - The **shutdown** command on LAG “xyz” disables the LAG and retains the user commands. However, the system does not allow the channel number “xyz” to be statically created.
 - The command **no interface port-channel channel-number** deletes the specified LAG, including a dynamically created LAG. This command causes all LACP-specific commands on the member interfaces to be removed. The interfaces are restored to a state that is ready to be configured.

Note: There will be no configuration on the interface since that condition is required for an interface to be part of a LAG.
- Link dampening can be configured on individual members of a LAG. See [Link Debounce Timer](#) for more information.

LACP modes

FTOS provides the following three modes for configuration of LACP:

- **Off**—In this state, an interface is not capable of being part of a dynamic LAG. LACP does not run on any port that is configured to be in this state.
- **Active**—In this state, the interface is said to be in the “active negotiating state.” LACP runs on any link that is configured to be in this state. A port in Active state also automatically initiates negotiations with other ports by initiating LACP packets.
- **Passive**—In this state, the interface is not in an active negotiating state, but LACP will run on the link. A port in Passive state also responds to negotiation requests (from ports in Active state). Ports in Passive state respond to LACP packets.

FTOS supports LAGs in the following cases:

- A port in Active state can set up a port channel (LAG) with another port in Active state.
- A port in Active state can set up a LAG with another port in Passive state.

A port in Passive state cannot set up a LAG with another port in Passive state.

LACP Configuration Commands

If aggregated ports are configured with compatible LACP modes (Off, Active, Passive), LACP can automatically link them, as defined in IEEE 802.3, Section 43. The following commands configure LACP:

| Command Syntax | Command Mode | Purpose |
|---|---------------|---|
| <code>[no] lacp system-priority</code> <i>priority-value</i> | CONFIGURATION | Configure the system priority. Range: 1– 65535 (the higher the number, the lower the priority) Default: 32768 |
| <code>[no] port-channel-protocol lacp</code> | INTERFACE | Enable or disable LACP on any LAN port: <ul style="list-style-type: none">• Default is “LACP disabled”• This command creates a new context. |
| <code>[no] port-channel</code> <i>number</i> mode <code>[active passive off]</code> | LACP | Configure LACP mode. <ul style="list-style-type: none">• Default is “LACP active”• number cannot statically contain any links |
| <code>[no] lacp port-priority</code> <i>priority-value</i> | LACP | Configure port priority. <ul style="list-style-type: none">• Ranges: 1 – 65535 (the higher the number, the lower the priority)• Default: 32768 |

LACP Configuration Tasks

The tasks covered in this section are:

- [Create a LAG](#)
- [Configure the LAG interfaces as dynamic](#)
- [Set the LACP long timeout](#)
- [Monitor and Debugging LACP](#)
- [Configure Shared LAG State Tracking](#)

Create a LAG

To create a dynamic port channel (LAG), define the LAG and then the LAG interfaces. Use the **interface port-channel** and **switchport** commands, as shown in the following example, which uses the example of LAG 32:

```
FTOS(conf)#interface port-channel 32
FTOS(conf-if-po-32)#no shutdown
FTOS(conf-if-po-32)#switchport
```

The LAG is in the default VLAN. To place the LAG into a non-default VLAN, use the **tagged** command on the LAG as shown in the example below:

```
FTOS(conf)#interface vlan 10
FTOS(conf-if-vl-10)#tagged port-channel 32
```

Configure the LAG interfaces as dynamic

After creating a LAG, configure the dynamic LAG interfaces. The following example shows ports 3/15, 3/16, 4/15, and 4/16 added to LAG 32 in LACP mode with the command **port-channel-protocol lacp**.

```
FTOS(conf)#interface GigabitEthernet 3/15
FTOS(conf-if-gi-3/15)#no shutdown
FTOS(conf-if-gi-3/15)#port-channel-protocol lacp
FTOS(conf-if-gi-3/15-lacp)#port-channel 32 mode active
...
FTOS(conf)#interface GigabitEthernet 3/16
FTOS(conf-if-gi-3/16)#no shutdown
FTOS(conf-if-gi-3/16)#port-channel-protocol lacp
FTOS(conf-if-gi-3/16-lacp)#port-channel 32 mode active
...
FTOS(conf)#interface GigabitEthernet 4/15
FTOS(conf-if-gi-4/15)#no shutdown
FTOS(conf-if-gi-4/15)#port-channel-protocol lacp
FTOS(conf-if-gi-4/15-lacp)#port-channel 32 mode active
...
FTOS(conf)#interface GigabitEthernet 4/16
FTOS(conf-if-gi-4/16)#no shutdown
FTOS(conf-if-gi-4/16)#port-channel-protocol lacp
FTOS(conf-if-gi-4/16-lacp)#port-channel 32 mode active
```

The **port-channel 32 mode active** command shown above may be successfully issued as long as there is no existing static channel-member configuration in LAG 32.

Set the LACP long timeout

PDUs are exchanged between port channel (LAG) interfaces to maintain LACP sessions. PDUs are transmitted at either a slow or fast transmission rate, depending upon the LACP timeout value. The timeout value is the amount of time that a LAG interface waits for a PDU from the remote system before bringing the LACP session down. The default timeout value is 1 second; it can be configured to be 30 seconds. Invoking the longer timeout might prevent the LAG from flapping if the remote system is up but temporarily unable to transmit PDUs due to a system interruption.



Note: The 30-second timeout is available for dynamic LAG interfaces only. The **lacp long-timeout** command can be entered for static LAGs, but it has no effect.

To configure the LACP long timeout as shown in the example below:

| Step | Task | Command Syntax | Command Mode |
|------|---|--------------------------|---------------|
| 1 | Set the LACP timeout value to 30 seconds. | lacp long-timeout | CONFIG-INT-PO |

```

FTOS(conf)# interface port-channel 32
FTOS(conf-if-po-32)#no shutdown
FTOS(conf-if-po-32)#switchport
FTOS(conf-if-po-32)#lacp long-timeout
FTOS(conf-if-po-32)#end
FTOS# show lacp 32
Port-channel 32 admin up, oper up, mode lacp
Actor System ID: Priority 32768, Address 0001.e800.a12b
Partner System ID: Priority 32768, Address 0001.e801.45a5
Actor Admin Key 1, Oper Key 1, Partner Oper Key 1
LACP LAG 1 is an aggregatable link
A - Active LACP, B - Passive LACP, C - Short Timeout, D - Long Timeout
E - Aggregatable Link, F - Individual Link, G - IN_SYNC, H - OUT_OF_SYNC
I - Collection enabled, J - Collection disabled, K - Distribution enabled L -
Distribution disabled,
M - Partner Defaulted, N - Partner Non-defaulted, O - Receiver is in expired
state,
P - Receiver is not in expired state
Port Gi 10/6 is enabled, LACP is enabled and mode is lacp
Actor Admin: State ADEHJLMP Key 1 Priority 128

```



Note: View PDU exchanges and the timeout value using the command **debug lacp**. See [Monitor and Debugging LACP](#).

Monitor and Debugging LACP

The system log (syslog) records faulty LACP actions.

To debug LACP, use the following command:

| Command Syntax | Command Mode | Purpose |
|--|--------------|---|
| [no] debug lacp [config events pdu [in out [interface [in out]]]] | EXEC | Debug LACP, including configuration and events. |

Shared LAG State Tracking

Shared LAG State Tracking provides the flexibility to bring down a port channel (LAG) based on the operational state of another LAG. At any time, only two LAGs can be a part of a group such that the fate (status) of one LAG depends on the other LAG.

In the following illustration, line-rate traffic from R1 destined for R4 follows the lowest-cost route via R2, as shown. Traffic is equally distributed between LAGs 1 and 2. If LAG 1 fails, all traffic from R1 to R4 flows across LAG 2 only. This condition over-subscribes the link, and packets are dropped.

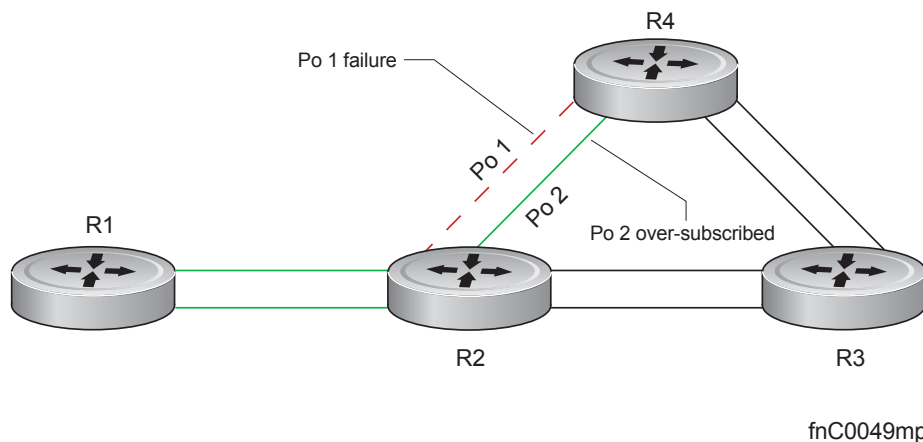

To avoid packet loss, traffic must be re-directed through the next lowest-cost link (R3 to R4). FTOS has the ability to bring LAG 2 down in the event that LAG 1 fails, so that traffic can be re-directed, as described. This is what is meant by Shared LAG State Tracking. To achieve this functionality, you must group LAG 1 and LAG 2 into a single entity, called a *failover group*.

Configure Shared LAG State Tracking

To configure Shared LAG State Tracking, you configure a failover group :



Note: If a LAG interface is part of a redundant pair, it cannot be used as a member of a failover group created for Shared LAG State Tracking.

| Step | Task | Command | Command Mode |
|------|--|---|------------------------|
| 1 | Enter port-channel failover group mode. | port-channel failover-group | CONFIGURATION |
| 2 | Create a failover group and specify the two port-channels that will be members of the group. | group number port-channel number port-channel number | CONFIG-PO-FAILOVER-GRP |

In the following example, LAGs 1 and 2 have been placed into to the same failover group.

```
R2#config
R2(conf)#port-channel failover-group
R2(conf-po-failover-grp)#group 1 port-channel 1 port-channel 2
```

View the failover group configuration using the **show running-configuration po-failover-group** command, as shown in the example below.

```
R2#show running-config po-failover-group
!
port-channel failover-group
  group 1 port-channel 1 port-channel 2
```

In the following illustration, LAGs 1 and 2 are members of a failover group. LAG 1 fails and LAG 2 is brought down upon the failure. This effect is logged by [Message 1](#), in which a console message declares both LAGs down at the same time.

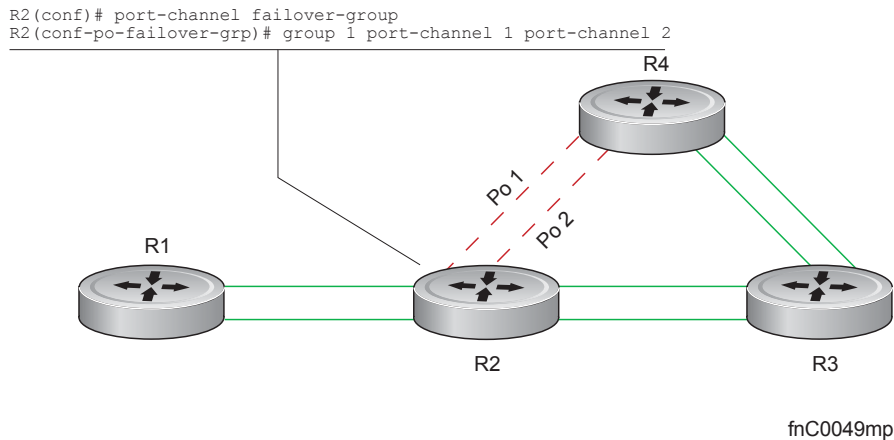

Message 1 Shared LAG State Tracking Console Message

```
2dlh45m: %RPM0-P:CP %IFMGR-5-OSTATE_DN: Changed interface state to down: Po 1
2dlh45m: %RPM0-P:CP %IFMGR-5-OSTATE_DN: Changed interface state to down: Po 2
```

View the status of a failover group member using the command **show interface port-channel**, as shown in the following example.

```
R2#show interface Port-channel 2
Port-channel 2 is up, line protocol is down (Failover-group 1 is down)
Hardware address is 00:01:e8:05:e8:4c, Current address is 00:01:e8:05:e8:4c
Interface index is 1107755010
Minimum number of links to bring Port-channel up is 1
Port-channel is part of failover-group 1
Internet address is not set
MTU 1554 bytes, IP MTU 1500 bytes
LineSpeed 1000 Mbit
Members in this channel:  Gi 1/17(U)
ARP type: ARPA, ARP Timeout 04:00:00
```

Last clearing of "show interface" counters 00:01:28
 Queuing strategy: fifo



Note: The set of console messages shown in [Message 1](#) appear only if Shared LAG State Tracking is configured on that router (the feature can be configured on one or both sides of a link). For example, in previous illustration, if Shared LAG State Tracking is configured on R2 only, then no messages appear on R4 regarding the state of LAGs in a failover group.

Important Points about Shared LAG State Tracking

- This feature is available for static and dynamic LAGs.
- Only a LAG can be a member of a failover group.
- Shared LAG State Tracking can be configured on one side of a link or on both sides.
- If a LAG that is part of a failover group is deleted, the failover group is deleted.
- If a LAG moves to the down state due to this feature, its members may still be in the up state.

Configure LACP as Hitless

[Configure LACP as Hitless](#) is supported only on platforms: **C e**

LACP on Dell Force10 systems can be configured to be hitless. When configured as hitless, there is no noticeable impact on dynamic LAG state upon an RPM failover. Critical LACP state information is synchronized between the two RPMs. Dynamic LAG interfaces in a redundant pair can be in a hitless LACP configuration.

Configure LACP to be hitless using the command **redundancy protocol lacp** from CONFIGURATION mode, as shown in the following example.

```
FTOS(conf)#redundancy protocol lacp
FTOS#show running-config redundancy
!
redundancy protocol lacp
FTOS#
FTOS#show running-config interface gigabitethernet 0/12
!
interface GigabitEthernet 0/12
  no ip address
!
  port-channel-protocol LACP
  port-channel 200 mode active
  no shutdown
```

LACP Basic Configuration Example

The screenshots in this section are based on the example topology shown in the following illustration. Two routers are named ALPHA and BRAVO, and their hostname prompts reflect those names.

The sections are:

- [Configuring a LAG on ALPHA](#)
- [Summary of the configuration on ALPHA](#)
- [Summary of the configuration on BRAVO](#)

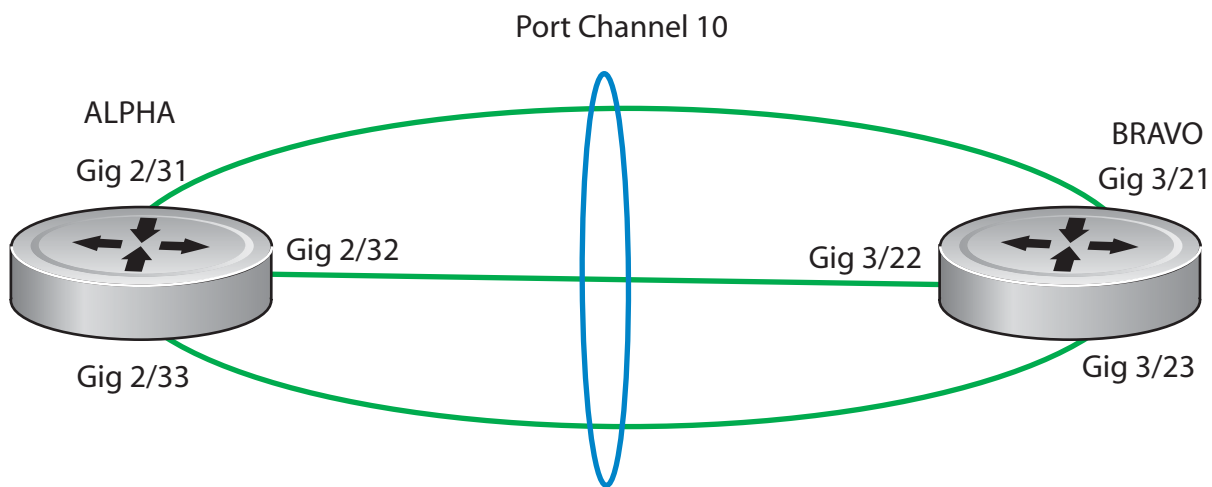

Configuring a LAG on ALPHA

Creating a LAG on ALPHA

```
Alpha(conf)#interface port-channel 10
Alpha(conf-if-po-10)#no ip address
Alpha(conf-if-po-10)#switchport
Alpha(conf-if-po-10)#no shutdown
Alpha(conf-if-po-10)#show config
!
interface Port-channel 10
  no ip address
  switchport
  no shutdown
!
Alpha(conf-if-po-10)#
```

Inspecting a LAG Port Configuration on ALPHA

```
Alpha#sh int gig 2/31
GigabitEthernet 2/31 is up, line protocol is up
Port is part of Port-channel 10
Hardware is Force10Eth, address is 00:01:e8:06:95:c0
    Current address is 00:01:e8:06:95:c0
Interface Index is 109101113
Port will not be disabled on partial SFM failure
Internet address is not set
MTU 1554 bytes, IP MTU 1500 bytes
LineSpeed 1000 Mbit, Mode full duplex, Slave
Flowcontrol rx on tx on
ARP type: ARPA, ARP Timeout 04:00:00
Last clearing of "show interface" counters 00:02:11
Queueing strategy: fifo
Input statistics:
    132 packets, 163668 bytes
    0 Vlans
    0 64-byte pkts, 12 over 64-byte pkts, 120 over 127-byte pkts
    0 over 255-byte pkts, 0 over 511-byte pkts, 0 over 1023-byte pkts
    132 Multicasts, 0 Broadcasts
    0 runts, 0 giants, 0 throttles
    0 CRC, 0 overrun, 0 discarded
Output Statistics
    136 packets, 16718 bytes, 0 underruns
    0 64-byte pkts, 15 over 64-byte pkts, 121 over 127-byte pkts
    0 over 255-byte pkts, 0 over 511-byte pkts, 0 over 1023-byte pkts
    136 Multicasts, 0 Broadcasts, 0 Unicasts
    0 Vlans, 0 throttles, 0 discarded, 0 collisions, 0 wredrops
Rate info (interval 299 seconds):
    Input 00.00 Mbits/sec,0 packets/sec, 0.00% of line-rate
    Output 00.00 Mbits/sec,0 packets/sec, 0.00% of line-rate
    Time since last interface status change: 00:02:14
```

```
Alpha#sh int gig 2/31
GigabitEthernet 2/31 is up, line protocol is up
Port is part of Port-channel 10
Hardware is Force10Eth, address is 00:01:e8:06:95:c0
Current address is 00:01:e8:06:95:c0
Interface index is 109101113
Port will not be disabled on partial SFM failure
Internet address is not set
MTU 1554 bytes, IP MTU 1500 bytes
LineSpeed 1000 Mbit, Mode full duplex, Slave
Flowcontrol rx on tx on
ARP type: ARPA, ARP Timeout 04:00:00
Last clearing of "show interface" counters 00:02:11
Queueing strategy: fifo
Input Statistics:
  132 packets, 16368 bytes
  0 Vlans
  0 64-byte pkts, 12 over 64-byte pkts, 120 over 127-byte pkts
  0 over 255-byte pkts, 0 over 511-byte pkts, 0 over 1023-byte pkts
  132 Multicasts, 0 Broadcasts
  0 runts, 0 giants, 0 throttles
  0 CRC, 0 overrun, 0 discarded
Output Statistics:
  136 packets, 16718 bytes, 0 underruns
  0 64-byte pkts, 15 over 64-byte pkts, 121 over 127-byte pkts
  0 over 255-byte pkts, 0 over 511-byte pkts, 0 over 1023-byte pkts
  136 Multicasts, 0 Broadcasts, 0 Unicasts
  0 Vlans, 0 throttles, 0 discarded, 0 collisions, 0 wredrops
Rate info (interval 299 seconds):
  Input 00.00 Mbits/sec,    0 packets/sec, 0.00% of line-rate
  Output 00.00 Mbits/sec,  0 packets/sec, 0.00% of line-rate
Time since last interface status change: 00:02:14
```

Shows the status of this physical interface,
and shows it is part of port channel 10.

Shows the speed of this physical interface.
Also shows it is the slave of the GigE link.

Inspecting Configuration of LAG 10 on ALPHA

```

Alpha#show int port-channel 10
Port-channel 10 is up,line protocol is up
Created by LACP protocol
Hardware address is 00:01:e8:06:96:63, Current address is 00:01:e8:06:96:63
Interface index is 1107755018
Minimum number of links to bring Port-channel up is 1
Internet address is not set
MTU 1554 bytes, IP MTU 1500 bytes
LineSpeed 3000 Mbit
Members in this channel: Gi 2/31(U) Gi 2/32(U) Gi 2/33(U)
ARP type: ARPA, ARP Timeout 04:00:00
Last clearing of "show interface" counters 00:04:09
Queueing strategy: fifo
Input Statistics:
  621 packets, 78732 bytes
  0 Vlans
  0 64-byte pkts, 18 over 64-byte pkts, 603 over 127-byte pkts
  0 over 255-byte pkts, 0 over 511-byte pkts, 0 over 1023-byte pkts
  621 Multicasts, 0 Broadcasts
  0 runts, 0 giants, 0 throttles
  0 CRC, 0 overrun, 0 discarded
Output Statistics:
  630 packets, 79284 bytes, 0 underruns
  0 64-byte pkts, 30 over 64-byte pkts, 600 over 127-byte pkts
  0 over 255-byte pkts, 0 over 511-byte pkts, 0 over 1023-byte pkts
  630 Multicasts, 0 Broadcasts, 0 Unicasts
  0 Vlans, 0 throttles, 0 discarded, 0 collisions, 0 wredrops
Rate info (interval 299 seconds):
  Input 00.00 Mbits/sec,    2 packets/sec, 0.00% of line-rate
  Output 00.00 Mbits/sec,  2 packets/sec, 0.00% of line-rate
Time since last interface status change: 00:03:38

```

Indicates the MAC address assigned to the LAG. This does NOT match any of the physical interface MAC addresses.

Confirms the number of links to bring up the LAG and that this is a switch port instead of a router port.

Confirms the total bandwidth for this LAG and which interfaces are active.

Using the show lacp Command to Verify LAG 10 Status on ALPHA

```
Alpha#sho lacp 10
```

```
Port-channel 10 admin up, oper up, mode lacp
```

Shows LAG status

```
Actor System ID: Priority 32768, Address 0001.e806.953e
```

```
Partner System ID: Priority 32768, Address 0001.e809.c24a
```

```
Actor Admin Key 10, Oper Key 10, Partner Oper Key 10
```

```
LACP LAG 10 is an aggregatable link
```

A - Active LACP, B - Passive LACP, C - Short Timeout, D - Long Timeout

E - Aggregatable Link, F - Individual Link, G - IN_SYNC, H - OUT_OF_SYNC

I - Collection enabled, J - Collection disabled, K - Distribution enabled

L - Distribution disabled, M - Partner Defaulted, N - Partner Non-defaulted,

O - Receiver is in expired state, P - Receiver is not in expired state

```
Port Gi 2/31 is enabled, LACP is enabled and mode is lacp
```

```
Actor Admin: State ACEHJLMP Key 10 Priority 32768
```

```
Oper: State ACEGIKNP Key 10 Priority 32768
```

```
Partner Admin: State BDFHJLMP Key 0 Priority 0
```

```
Oper: State ACEGIKNP Key 10 Priority 32768
```

Interfaces participating in the LAG are included here.

```
Port Gi 2/32 is enabled, LACP is enabled and mode is lacp
```

```
Actor Admin: State ACEHJLMP Key 10 Priority 32768
```

```
Oper: State ACEGIKNP Key 10 Priority 32768
```

```
Partner Admin: State BDFHJLMP Key 0 Priority 0
```

```
Oper: State ACEGIKNP Key 10 Priority 32768
```

```
Port Gi 2/33 is enabled, LACP is enabled and mode is lacp
```

```
Actor Admin: State ACEHJLMP Key 10 Priority 32768
```

```
Oper: State ACEGIKNP Key 10 Priority 32768
```

```
Partner Admin: State BDFHJLMP Key 0 Priority 0
```

```
Oper: State ACEGIKNP Key 10 Priority 32768
```

```
Alpha#
```

Summary of the configuration on ALPHA

Summary of the configuration on ALPHA

```
Alpha(conf-if-po-10)#int gig 2/31
Alpha(conf-if-gi-2/31)#no ip address
Alpha(conf-if-gi-2/31)#no switchport
Alpha(conf-if-gi-2/31)#shutdown
Alpha(conf-if-gi-2/31)#port-channel-protocol lacp
Alpha(conf-if-gi-2/31-lACP)#port-channel 10 mode active
Alpha(conf-if-gi-2/31-lACP)#no shut
Alpha(conf-if-gi-2/31)#show config

!
interface GigabitEthernet 2/31
  no ip address
!
  port-channel-protocol LACP
  port-channel 10 mode active
  no shutdown
!
Alpha(conf-if-gi-2/31)#

interface Port-channel 10
  no ip address
  switchport
  no shutdown

interface GigabitEthernet 2/31
  no ip address
```

Summary of the configuration on BRAVO

Summary of the configuration on BRAVO

```
Bravo(conf-if-gi-3/21)#int port-channel 10
Bravo(conf-if-po-10)#no ip add
Bravo(conf-if-po-10)#switch
Bravo(conf-if-po-10)#no shut
Bravo(conf-if-po-10)#show config
!
interface Port-channel 10
  no ip address
  switchport
  no shutdown
!
Bravo(conf-if-po-10)#exit

Bravo(conf)#int gig 3/21
Bravo(conf)#no ip address
Bravo(conf)#no switchport
Bravo(conf)#shutdown
Bravo(conf-if-gi-3/21)#port-channel-protocol lacp
Bravo(conf-if-gi-3/21-lacp)#port-channel 10 mode active
Bravo(conf-if-gi-3/21-lacp)#no shut
Bravo(conf-if-gi-3/21)#end

!
interface GigabitEthernet 3/21
  no ip address
!
  port-channel-protocol LACP
  port-channel 10 mode active
  no shutdown
Bravo(conf-if-gi-3/21)#end

int port-channel 10
no ip address
switchport
no shutdown
show config

int gig 3/21
no ip address
```

Using the show interface Command to Inspect a LAG Port on BRAVO

```
Bravo#show int gig 3/21
```

```
GigabitEthernet 3/21 is up, line protocol is up
Port is part of Port-channel 10
```

```
Hardware is Force10Eth, address is 00:01:e8:09:c3:82
```

```
Current address is 00:01:e8:09:c3:82
```

```
Interface index is 140034106
```

```
Internet address is not set
```

```
MTU 1554 bytes, IP MTU 1500 bytes
```

```
LineSpeed 1000 Mbit, Mode full duplex, Master
```

```
Flowcontrol rx on tx on
```

```
ARP type: ARPA, ARP Timeout 04:00:00
```

```
Last clearing of "show interface" counters 00:15:05
```

```
Queueing strategy: fifo
```

```
Input Statistics:
```

```
708 packets, 89934 bytes
```

```
0 Vlans
```

```
0 64-byte pkts, 15 over 64-byte pkts, 693 over 127-byte pkts
```

```
0 over 255-byte pkts, 0 over 511-byte pkts, 0 over 1023-byte pkts
```

```
708 Multicasts, 0 Broadcasts
```

```
0 runs, 0 giants, 0 throttles
```

```
0 CRC, 0 overrun, 0 discarded
```

```
Output Statistics:
```

```
705 packets, 89712 bytes, 0 underruns
```

```
0 64-byte pkts, 12 over 64-byte pkts, 693 over 127-byte pkts
```

```
0 over 255-byte pkts, 0 over 511-byte pkts, 0 over 1023-byte pkts
```

```
705 Multicasts, 0 Broadcasts, 0 Unicasts
```

```
0 Vlans, 0 throttles, 0 discarded, 0 collisions, 0 wredrops
```

```
Rate info (interval 299 seconds):
```

```
Input 00.00 Mbits/sec, 0 packets/sec, 0.00% of line-rate
```

```
Output 00.00 Mbits/sec, 0 packets/sec, 0.00% of line-rate
```

```
Time since last interface status change: 00:12:39
```

Also shows it is part of LAG 10.

Shows that this is a Layer 2 port.

Shows the speed of this physical interface.
Also shows it is the Master of the GigE link.

Using the show interfaces port-channel Command to Inspect LAG 10

```
FTOS#sh int port 10
Port-channel 10 is up, line protocol is up
Created by LACP protocol
Hardware address is 00:01:e8:09:c4:ef, Current address is 00:01:e8:09:c4:ef
Interface index is 1107755018
Minimum number of links to bring Port-channel up is 1
Internet address is not set
MTU 1554 bytes, IP MTU 1500 bytes
LineSpeed 3000 Mbit
Members in this channel: Gi 3/21(U) Gi 3/22(U) Gi 3/23(U)
ARP type: ARPA, ARP Timeout 04:00:00
Last clearing of "show interface" counters 00:13:07
Queueing strategy: fifo
Input Statistics:
  2189 packets, 278744 bytes
  0 Vlans
  0 64-byte pkts, 32 over 64-byte pkts, 2157 over 127-byte pkts
  0 over 255-byte pkts, 0 over 511-byte pkts, 0 over 1023-byte pkts
  2189 Multicasts, 0 Broadcasts
  0 runts, 0 giants, 0 throttles
  0 CRC, 0 overrun, 0 discarded
Output Statistics:
  2173 packets, 277350 bytes, 0 underruns
  0 64-byte pkts, 19 over 64-byte pkts, 2154 over 127-byte pkts
  0 over 255-byte pkts, 0 over 511-byte pkts, 0 over 1023-byte pkts
  2173 Multicasts, 0 Broadcasts, 0 Unicasts
  0 Vlans, 0 throttles, 0 discarded, 0 collisions, 0 wredrops
Rate info (interval 299 seconds):
  Input 00.00 Mbits/sec,    2 packets/sec, 0.00% of line-rate
  Output 00.00 Mbits/sec,  2 packets/sec, 0.00% of line-rate
Time since last interface status change: 00:13:00
```

Indicates the MAC address assigned to the LAG. This does NOT match any of the physical interface MAC addresses.

Confirms the number of links to bring up the LAG and that this is a switch port instead of a router port.

Confirms the total bandwidth for this LAG and which interfaces are active.

FTOS#

Using the show lacp Command to Inspect LAG Status

```
FTOS#show lacp 10
```

```
Port-channel 10 admin up, oper up, mode lacp
```

Shows LAG status

```
Actor System ID: Priority 32768, Address 0001.e809.c24a
```

```
Partner System ID: Priority 32768, Address 0001.e806.953e
```

```
Actor Admin Key 10, Oper Key 10, Partner Oper Key 10
```

```
LACP LAG 10 is an aggregatable link
```

A - Active LACP, B - Passive LACP, C - Short Timeout, D - Long Timeout

E - Aggregatable Link, F - Individual Link, G - IN_SYNC, H - OUT_OF_SYNC

I - Collection enabled, J - Collection disabled, K - Distribution enabled

L - Distribution disabled, M - Partner Defaulted, N - Partner Non-defaulted,

O - Receiver is in expired state, P - Receiver is not in expired state

```
Port Gi 3/21 is enabled, LACP is enabled and mode is lacp
```

```
Actor Admin: State ACEHJLMP Key 10 Priority 32768
```

```
Oper: State ACEGIKNP Key 10 Priority 32768
```

```
Partner Admin: State BDFHJLMP Key 0 Priority 0
```

```
Oper: State ACEGIKNP Key 10 Priority 32768
```

```
Port Gi 3/22 is enabled, LACP is enabled and mode is lacp
```

```
Actor Admin: State ACEHJLMP Key 10 Priority 32768
```

```
Oper: State ACEGIKNP Key 10 Priority 32768
```

```
Partner Admin: State BDFHJLMP Key 0 Priority 0
```

```
Oper: State ACEGIKNP Key 10 Priority 32768
```

Interfaces participating in the LAG
are included here.

```
Port Gi 3/23 is enabled, LACP is enabled and mode is lacp
```

```
Actor Admin: State ACEHJLMP Key 10 Priority 32768
```

```
Oper: State ACEGIKNP Key 10 Priority 32768
```

```
Partner Admin: State BDFHJLMP Key 0 Priority 0
```

```
Oper: State ACEGIKNP Key 10 Priority 32768
```

```
FTOS#
```

PPP is a connection-oriented protocol that enables layer two links over a variety of different physical layer connections. It is supported on both synchronous and asynchronous lines, and can operate in half-duplex or full-duplex mode. It was designed to carry IP traffic but is general enough to allow any type of network layer datagram to be sent over a PPP connection. As its name implies, it is for point-to-point connections between exactly two devices, and assumes that frames are sent and received in the same order.

Layer 2

Layer 2 features are supported on platforms: e C S **S4810** **S4820T**

This chapter describes the following Layer 2 features:

- Managing the MAC Address Table
- MAC Learning Limit
- NIC Teaming
- Microsoft Clustering
- Configuring Redundant Pairs
- Restricting Layer 2 Flooding
- Restricting Layer 2 Multicast Flooding over Low Speed Ports
- Far-end Failure Detection

Managing the MAC Address Table

FTOS provides the following management activities for the MAC address table:

- Clear the MAC Address Table
- Set the Aging Time for Dynamic Entries
- Configure a Static MAC Address
- Display the MAC Address Table

Clear the MAC Address Table

You may clear the MAC address table of dynamic entries:

| Task | Command Syntax | Command Mode |
|--|--|----------------|
| Clear a MAC address table of dynamic entries. <ul style="list-style-type: none"> • address deletes the specified entry • all deletes all dynamic entries • interface deletes all entries for the specified interface • vlan deletes all entries for the specified VLAN | clear mac-address-table {dynamic sticky} {address all interface vlan} | EXEC Privilege |

Set the Aging Time for Dynamic Entries

Learned MAC addresses are entered in the table as dynamic entries, which means that they are subject to aging. For any dynamic entry, if no packet arrives on the switch with the MAC address as the source or destination address within the timer period, the address is removed from the table. The default aging time is 1800 seconds.

| Task | Command Syntax | Command Mode |
|--|---|---------------|
| Disable MAC address aging for all dynamic entries. | mac-address-table aging-time 0 | CONFIGURATION |
| Specify an aging time. | mac-address-table aging-time <i>seconds</i> Range: 10-1000000 | CONFIGURATION |

Set the Aging Time for Dynamic Entries on a VLAN

Set the Aging Time for Dynamic Entries on a VLAN is available only on platform: 

| Task | Command Syntax | Command Mode |
|------------------------|--|----------------|
| Specify an aging time. | mac-address-table aging-time <i>seconds</i> Range: 1-1000000 | INTERFACE VLAN |

FTOS Behavior: The time elapsed before the configured MAC aging time expires is not precisely as configured. For example, the VLAN configuration **mac-address-table aging-time 1** does not remove dynamic entries from the CAM after precisely 1 second. The actual minimum aging time for entries is approximately 5 seconds because this is the default MAC address table scanning interval. Therefore, MAC aging configurations of less than 5 seconds, as in this example, might be ineffective. Configuring **mac-address-table station-move time-interval 500** solves this limitation. Reducing the scanning interval to the minimum, 500 milliseconds, increases the detection speed, which results in FTOS clearing entries closer to the actual desired aging time.

Configure a Static MAC Address

A static entry is one that is not subject to aging. Static entries must be entered manually:

| Task | Command Syntax | Command Mode |
|---|---------------------------------|---------------|
| Create a static MAC address entry in the MAC address table. | mac-address-table static | CONFIGURATION |

Display the MAC Address Table

To display the contents of the MAC address table:

| Task | Command Syntax | CommandMode |
|---|--|----------------|
| Display the contents of the MAC address table. <ul style="list-style-type: none">• address displays the specified entry.• aging-time displays the configured aging-time.• count displays the number of dynamic and static entries for all VLANs, and the total number of entries.• dynamic displays only dynamic entries• interface displays only entries for the specified interface.• static displays only static entries.• vlan displays only entries for the specified VLAN. | show mac-address-table [address aging-time [vlan <i>vlan-id</i>] count dynamic interface static vlan] | EXEC Privilege |

MAC Learning Limit

This section has the following sub-sections:

- [mac learning-limit dynamic](#)
- [mac learning-limit mac-address-sticky](#)
- [mac learning-limit station-move](#)
- [Learning Limit Violation Actions](#)
- [Station Move Violation Actions](#)
- [Recovering from Learning Limit and Station Move Violations](#)
- [Per-VLAN MAC Learning Limit](#)

MAC Address Learning Limit is a method of port security on Layer 2 port-channel and physical interfaces, and VLANs. It enables you to set an upper limit on the number of MAC addresses that learned on an interface/VLAN. After the limit is reached, the system drops all traffic from a device with an unlearned MAC address.

FTOS Behavior: When configuring MAC Learning Limit on a port or VLAN the configuration is accepted (becomes part of **running-config** and **show mac learning-limit interface**) before the system verifies that sufficient CAM space exists. If the CAM check fails, a message is displayed:

```
%E90MH:5 %ACL_AGENT-2-ACL_AGENT_LIST_ERROR: Unable to apply access-list Mac-Limit on GigabitEthernet 5/84
```

In this case, the configuration is still present in the running-config and **show** output. Remove the configuration before re-applying a MAC learning limit with lower value. Also, ensure that Syslog messages can be viewed on your session.

Note: The CAM-check failure message beginning in FTOS version 8.3.1.0 is different from versions 8.2.1.1 and earlier, which read:

```
% Error: ACL returned error
```

```
% Error: Remove existing limit configuration if it was configured before
```

To set a MAC learning limit on an interface:

| Task | Command Syntax | Command Mode |
|--|--|--------------|
| Specify the number of MAC addresses that the system can learn off a Layer 2 interface. | mac learning-limit <i>address_limit</i> | INTERFACE |

Three options are available with the **mac learning-limit** command: **dynamic**, **no-station-move**, and **station-move**.



Note: An SNMP trap is available for **mac learning-limit station-move**. No other SNMP traps are available for MAC Learning Limit, including limit violations.

mac learning-limit dynamic

The MAC address table is stored on the Layer 2 FIB region of the CAM (and the Layer 2 ACL region on the E-Series). On the C-Series and S-Series the Layer 2 FIB region allocates space for static MAC address entries and dynamic MAC address entries (all MAC address entries on the E-Series are dynamic). When MAC Learning Limit is enabled, entries created on this port are static by default. When you configure the **dynamic** option, learned MAC addresses are stored in the dynamic region and are subject to aging. Entries created before this option is set are not affected.

FTOS Behavior: If you do not configure the **dynamic** option, the C-Series and S-Series do not detect station moves in which a MAC address learned off of a MAC-limited port is learned on another port on same line card. Therefore, FTOS does not take any configured station-move violation action. When a MAC address is relearned on any other linecard (any line card except the one to which the original MAC-limited port belongs), the station-move is detected, and the system takes the configured the violation action.

mac learning-limit mac-address-sticky

Using sticky MAC addresses allows you to associate a specific port with MAC addresses from trusted devices. If sticky MAC is enabled, the specified port will retain any dynamically-learned addresses and prevent them from being transferred or learned on other ports.

If **mac-learning-limit** is configured and sticky MAC is enabled, all dynamically-learned addresses are converted to sticky MAC addresses for the selected port. Any new MAC addresses learned on this port will be converted to sticky MAC addresses.

To save all sticky MAC addresses into a configuration file that can be used as a startup configuration file, use the **write config** command. If the number of existing MAC addresses is fewer than the configured mac learn limit, any additional MAC addresses will be converted to sticky MACs on that interface. To remove all sticky MAC addresses from the running config file, disable sticky MAC and use the **write config** command.

When sticky mac is enabled on an interface, dynamically-learned MAC addresses will not age, even if **mac-learning-limit dynamic** is enabled. If **mac-learning-limit** and **mac-learning-limit dynamic** are configured and sticky MAC is disabled, any dynamically-learned MAC addresses will age.

mac learning-limit station-move

mac learning-limit station-move is available only on platforms: C S Z

The **station-move** option, allows a MAC address already in the table to be learned off of another interface. For example, if you disconnect a network device from one interface and reconnect it to another interface, the MAC address is learned on the new interface. When the system detects this “station move,” the system clears the entry learned on the original interface and installs a new entry on the new interface.



Learning Limit Violation Actions

Learning Limit Violation Actions are supported only on platforms: e **S60** **S4810** **S4820T**.

You can configure the system to take an action when the MAC learning limit is reached on an interface and a new address is received using one of the following options with the **mac learning-limit** command:

| Task | Command Syntax | Command Mode |
|--|---------------------------------------|--------------|
| Generate a system log message when the MAC learning limit is exceeded. | learn-limit-violation log | INTERFACE |
| Shut down the interface and generate a system log message when the MAC learning limit is exceeded. | learn-limit-violation shutdown | INTERFACE |

Station Move Violation Actions

Station Move Violation Actions are supported only on platforms:   .

no-station-move is the default behavior. You can configure the system to take an action if a station move occurs using one of the following options with the **mac learning-limit** command:

| Task | Command Syntax | Command Mode |
|--|--|--------------|
| Generate a system log message indicating a station move. | station-move-violation log | INTERFACE |
| Shut down the first port to learn the MAC address. | station-move-violation shutdown-original | INTERFACE |
| Shut down the second port to learn the MAC address. | station-move-violation shutdown-offending | INTERFACE |
| Shut down both the first and second port to learn the MAC address. | station-move-violation shutdown-both | INTERFACE |

To display a list of interfaces configured with MAC learning limit or station move violation actions:

| Task | Command Syntax | Command Mode |
|---|---|---------------|
| Display a list of all of the interfaces configured with MAC learning limit or station move violation. | show mac learning-limit violate-action | CONFIGURATION |

Recovering from Learning Limit and Station Move Violations

After a learning-limit or station-move violation shuts down an interface, you must manually reset it:

| Task | Command Syntax | Command Mode |
|--|--|----------------|
| Reset interfaces in ERR_Disabled state caused by a learning limit violation or station move violation. | mac learning-limit reset | EXEC Privilege |
| Reset interfaces in ERR_Disabled state caused by a learning limit violation. | mac learning-limit reset learn-limit-violation [interface all] | EXEC Privilege |
| Reset interfaces in ERR_Disabled state caused by a station move violation. | mac learning-limit reset station-move-violation [interface all] | EXEC Privilege |



Note: Alternatively, you can reset the interface by shutting it down using the **shutdown** command and then reenabling it using the command **no shutdown**.

Per-VLAN MAC Learning Limit

Per-VLAN MAC Learning Limit is available only on platform: e

An individual MAC learning limit can be configured for each VLAN using Per-VLAN MAC Learning Limit.

One application of Per-VLAN MAC Learning Limit is on access ports. In the following illustration, an Internet Exchange Point (IXP) connects multiple Internet Service Provider (ISP). An IXP can provide several types of services to its customers including public and private peering. Public peering means that all customers are connected to one VLAN. If one ISP wants to peer with another ISP, it establishes a BGP peering session over this VLAN. Private Peering means that the IXP sets up a separate VLAN between two customers that want to peer privately; only the ports of these two ISPs would belong to this VLAN and they would peer via BGP. In the following illustration, Per-VLAN MAC Learning Limit is used on the access ports for the ISPs that have subscribed to private and public peering since these access ports are members of multiple VLANs.

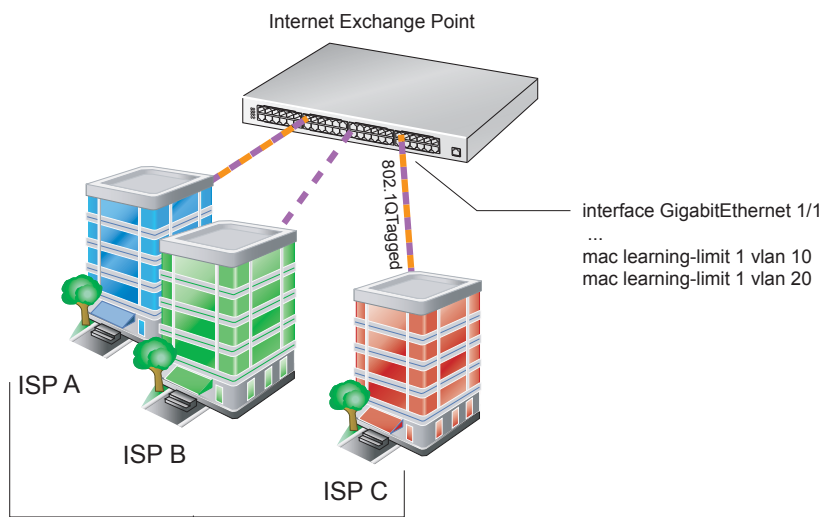

ISP A, B, and C are all public peers through VLAN 10. In addition, ISP A and C are private peers on a separate VLAN, VLAN 20. Since the access ports for ISP A and C are members of multiple VLANs, Per-VLAN MAC Learning Limit can be applied to those ports.

| Task | Command Syntax | Command Mode |
|---|--|----------------|
| Configure a MAC learning limit on a VLAN. | mac learning-limit <i>limit</i> vlan <i>vlan-id</i> | INTERFACE |
| Display the MAC learning limit counters for a VLAN. | show mac learning-limit [interface <i>slot/port</i> [vlan <i>vlan-id</i>]] | EXEC Privilege |

| Task | Command Syntax | Command Mode |
|--|----------------|--------------|
| FTOS#show mac learning-limit | | |
| Interface | Vlan | Learning |
| Slot/port | Id | Limit |
| Dynamic | Static | Unknown SA |
| MAC count | MAC count | Drops |
| Gi 5/84 | 2 | 2 |
| | | 0 |
| Gi 5/84 | * | 5 |
| | | 0 |
| Gi 5/85 | 3 | 3 |
| | | 0 |
| Gi 5/85 | * | 10 |
| | | 0 |
| FTOS#show mac learning-limit interface gig 5/84 | | |
| Interface | Vlan | Learning |
| Slot/port | Id | Limit |
| Dynamic | Static | Unknown SA |
| MAC count | MAC count | Drops |
| Gi 5/84 | 2 | 2 |
| | | 0 |
| Gi 5/84 | * | 5 |
| | | 0 |
| FTOS#show mac learning-limit interface gig 5/84 vlan 2 | | |
| Interface | Vlan | Learning |
| Slot/port | Id | Limit |
| Dynamic | Static | Unknown SA |
| MAC count | MAC count | Drops |
| Gi 5/84 | 2 | 2 |
| | | 0 |
| | | 0 |

NIC Teaming

NIC Teaming is available on the following platforms: **C e S**

NIC teaming is a feature that allows multiple network interface cards in a server to be represented by one MAC address and one IP address in order to provide transparent redundancy, balancing, and to fully utilize network adapter resources.

The following illustration shows a topology where two NICs have been teamed together. In this case, if the primary NIC fails, traffic switches to the secondary NIC since they are represented by the same set of addresses.

Figure 28-1. Redundant NICs with NIC Teaming

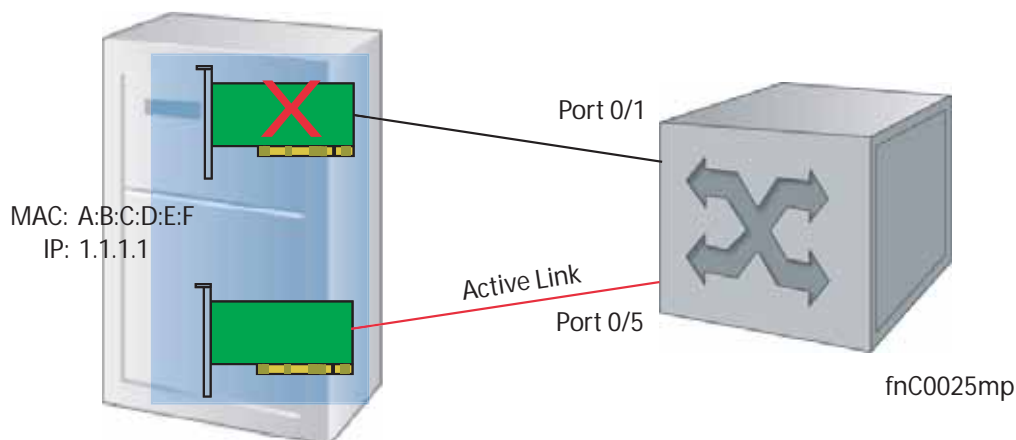

When NIC teaming is employed, consider that the server MAC address is originally learned on Port 0/1 of the switch (Figure 28-2) and Port 0/5 is the failover port. When the NIC fails, the system automatically sends an ARP request for the gateway or host NIC to resolve the ARP and refresh the egress interface. When the ARP is resolved, the same MAC address is learned on the same port where the ARP is resolved

(in the above example, this is Port 0/5 of the switch). To ensure the MAC address is disassociated with one port and re-associated with another port in the ARP table, you must configure the command **mac-address-table station-move refresh-arp** on the Dell Force10 switch at the time that NIC teaming is being configured on the server.



Note: If this command is not configured, traffic continues to be forwarded to the failed NIC until the ARP entry on the switch times out.

Figure 28-2. Configuring mac-address-table station-move refresh-arp Command

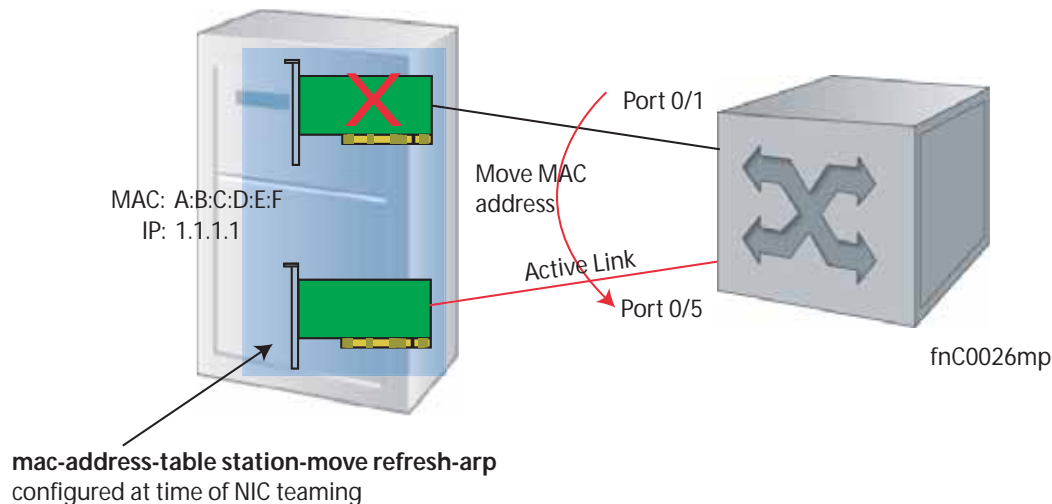

MAC Move Optimization

MAC Move Optimization is supported only on platform: **e**

Station-move detection takes 5000ms because this is the interval at which the detection algorithm runs. On the E-Series, you can reduce detection time to as little as 500ms using the command **mac-address-table station-move threshold time-interval** (though at the expense of CPU resources).

threshold is the number of times a station move must be detected in a single interval in order to trigger a system log message. For example, if you configure **mac-address-table station-move threshold 2 time-interval 5000**, and 4 station moves occur in 5000ms, then two log messages are generated.

Microsoft Clustering

Microsoft Clustering is supported only on platform: **e**

Microsoft Clustering allows multiple servers using Microsoft Windows to be represented by one MAC address and IP address in order to provide transparent failover or balancing. FTOS does not recognize server clusters by default; it must be configured to do so.

Default Behavior

When an ARP request is sent to a server cluster, either the active server or all of the servers send a reply, depending on the cluster configuration. If the active server sends a reply, the Dell Force10 switch learns the active server's MAC address. If all servers reply, the switch registers only the last received ARP reply, and the switch learns one server's actual MAC address (Figure 28-3); the virtual MAC address is never learned.

Since the virtual MAC address is never learned, traffic is forwarded to only one server rather than the entire cluster, and failover and balancing are not preserved (Figure 28-4).

Figure 28-3. Server Clustering: Multiple ARP Replies

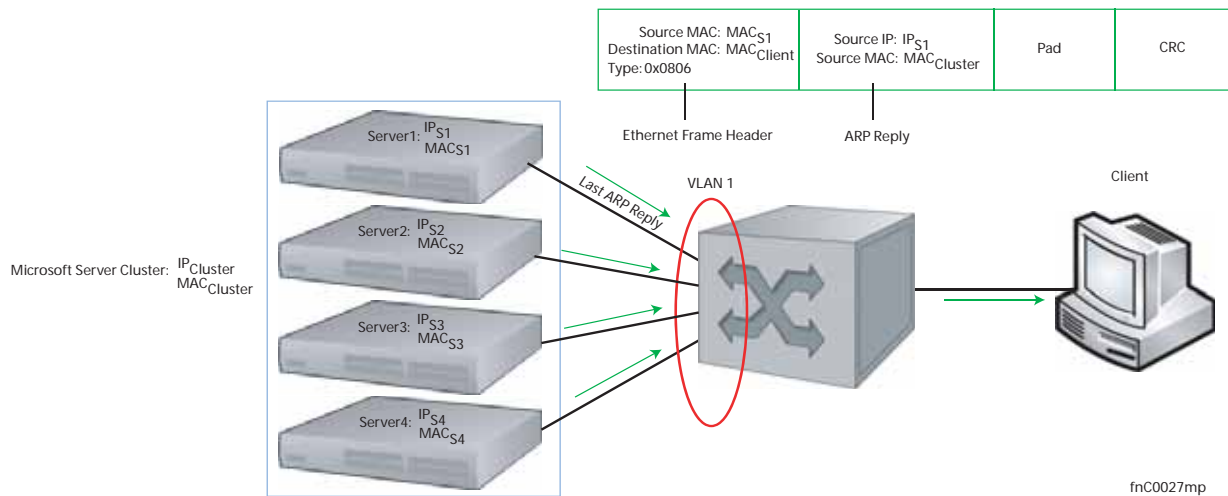
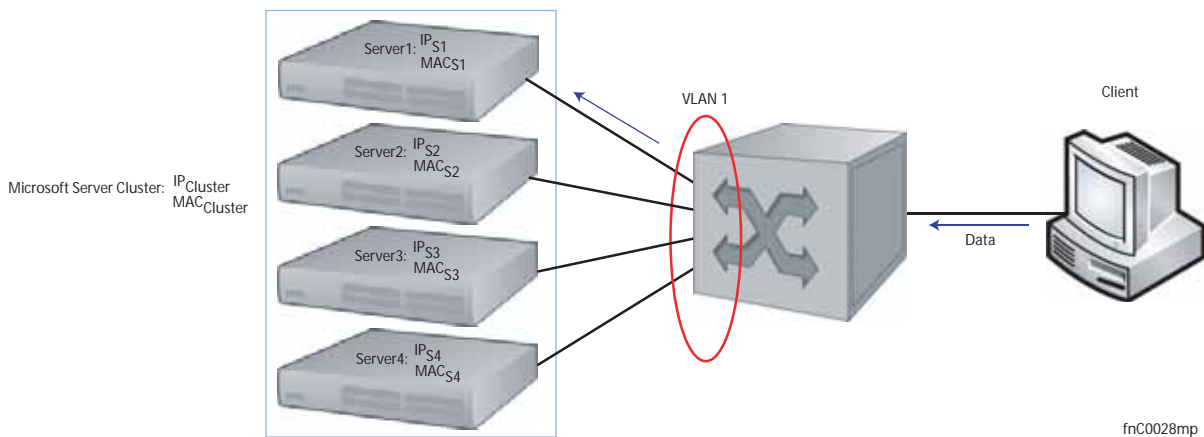

Figure 28-4. Server Clustering: Failover and Balancing Not Preserved



Configuring the Switch for Microsoft Server Clustering

To preserve failover and balancing, the Dell Force10 switch must learn the cluster's virtual MAC address, and it must forward traffic destined for the server cluster out all member ports in the VLAN connected to the cluster. To ensure that this happens, you must configure the command **vlan-flooding** on the Dell Force10 switch at the time that the Microsoft cluster is configured (Figure 28-5).

As shown in Figure 28-5, the server MAC address is given in the Ethernet frame header of the ARP reply, while the virtual MAC address representing the cluster is given in the payload. The **vlan-flooding** command directs the system to discover that there are different MAC addresses in an ARP reply and associate the virtual MAC address with the VLAN connected to the cluster. Then, all traffic destined for the cluster is flooded out of all member ports. Since all of the servers in the cluster receive traffic, failover and balancing are preserved.

Figure 28-5. Server Cluster: Failover and Balancing Preserved with the vlan-flooding Command

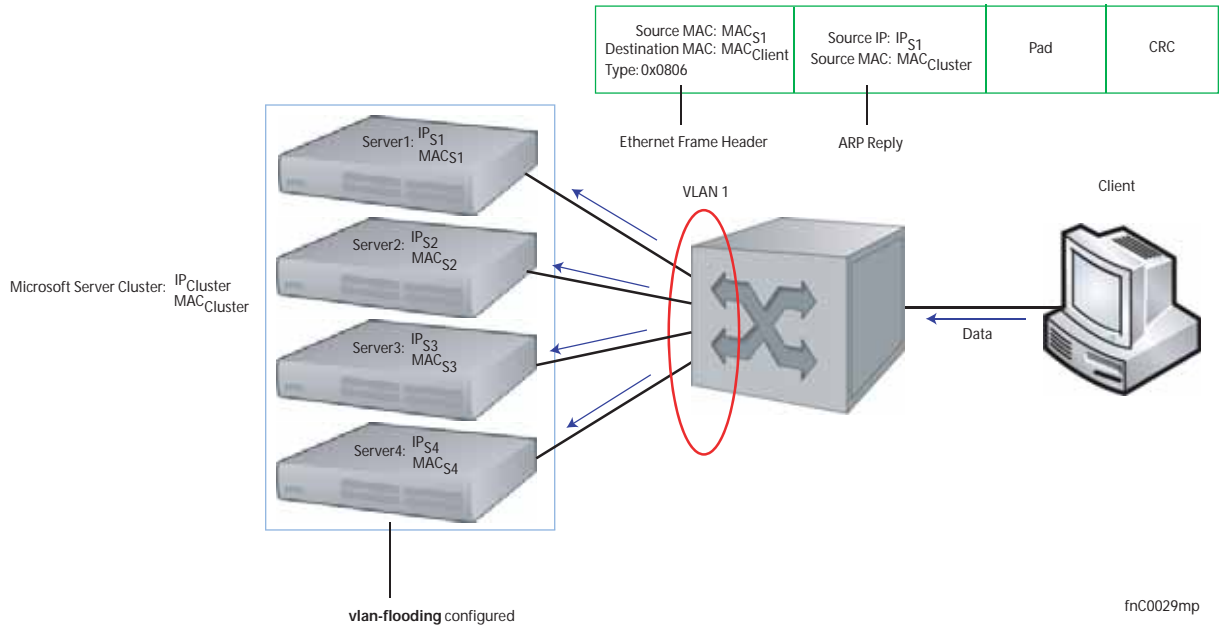

Enable and Disable VLAN Flooding

- ARP entries already resolved through the VLAN are deleted when the feature is enabled. This ensures that ARP entries across the VLAN are consistent.
- All ARP entries learned after the feature is enabled are deleted when the feature is disabled, and RP2 triggers ARP resolution. The feature is disabled with the command **no vlan-flooding**.
- When a port is added to the VLAN, the port automatically receives traffic if the feature is enabled. Old ARP entries are not deleted or updated.
- When a member port is deleted, its ARP entries are also deleted from the CAM.
- Port channels in the VLAN also receive traffic.
- There is no impact on the configuration from saving the configuration.
- The feature is not reflected in the output of the `show arp` command but is reflected in the output of the command **show ipf fib**.

The ARP entries exist in the secondary RPM CAM, so failover has no effect on the feature.

Configuring Redundant Pairs

Configuring Redundant Pairs is supported on platforms: **e c s** **S4810** **S4820T** **Z**

Networks that employ switches that do not support Spanning Tree (STP) — for example, networks with Digital Subscriber Line Access Multiplexers (DSLAM) — cannot have redundant links between switches because they create switching loops (Figure 28-6). The Redundant Pairs feature enables you to create redundant links in networks that do not use STP by configuring backup interfaces for the interfaces on either side of the primary link.



Note: For details on STP, see Chapter 48, “Spanning Tree Protocol (STP),” on page 945.

Assign a backup interface to an interface using the command **switchport backup**. The backup interface remains in down state until the primary fails, at which point it transitions to up state. If the primary interface fails, and later comes up, it becomes the backup interface for the redundant pair. FTOS supports Gigabit, 10-Gigabit, and 40-Gigabit interfaces as backup interfaces.

You must apply all other configurations to each interface in the redundant pair such that their configurations are *identical*, so that transition to the backup interface in the event of a failure is transparent to rest of the network.

Figure 28-6. Configuring Redundant Layer 2 Pairs without Spanning Tree

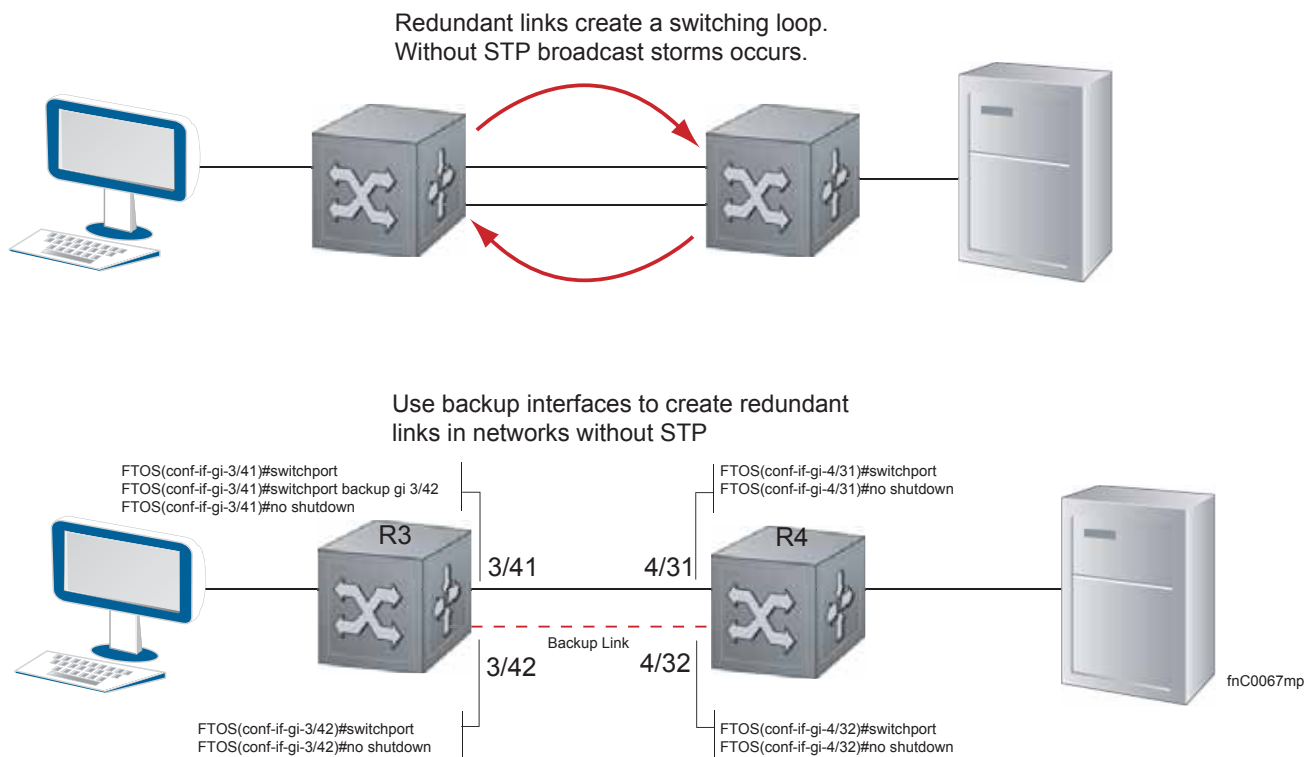

You configure a redundant pair by assigning a backup interface to a primary interface with the **switchport backup interface** command. Initially, the primary interface is active and transmits traffic and the backup interface remains down. If the primary fails for any reason, the backup transitions to an active UP state. If the primary interface fails and later comes back up, it remains as the backup interface for the redundant pair.

FTOS supports only Gigabit, 10-Gigabit, and 40-Gigabit ports and port channels as primary/backup interfaces in redundant pairs. (A port channel is also referred to as a Link Aggregation Group (LAG). See [Chapter 22, Interfaces, Port Channel Interfaces on page 446](#) for more information.) If the interface is a member link of a LAG, the following primary/backup interfaces are also supported:

- primary interface is a physical interface, the backup interface can be a physical interface
- primary interface is a physical interface, the backup interface can be a static or dynamic LAG
- primary interface is a static or dynamic LAG, the backup interface can be a physical interface
- primary interface is a static or dynamic LAG, the backup interface can be a static or dynamic LAG

In a redundant pair, any combination of physical and port-channel interfaces is supported as the two interfaces in a redundant pair. For example, you can configure a static (without LACP) or dynamic (with LACP) port-channel interface as either the primary or backup link in a redundant pair with a physical interface.

To ensure that existing network applications see no difference when a primary interface in a redundant pair transitions to the backup interface, be sure to apply *identical* configurations of other traffic parameters to each interface.

If you remove an interface in a redundant link (remove the line card of a physical interface or delete a port channel with the **no interface port-channel** command), the redundant pair configuration is also removed.

Important Points about Configuring Redundant Pairs

- You may not configure any interface to be a backup for more than one interface, no interface can have more than one backup, and a backup interface may not have a backup interface.
- Neither the active nor the backup interface may be a member of a LAG.
- The active and standby do *not* have to be of the same type (1G, 10G, etc).
- You may not enable any Layer 2 protocol on any interface of a redundant pair or to ports connected to them.

In [Figure 28-7](#), interface 3/41 is a backup interface for 3/42, and 3/42 is in the down state, as shown in message [Message 1](#). If 3/41 fails, 3/42 transitions to the up state, which makes the backup link active. A message similar to [Message 1](#) appears whenever you configure a backup port.

Message 1 Configuring a Backup Layer 2 Port

```
02:28:04: %RPM0-P:CP %IFMGR-5-L2BKUP_WARN: Do not run any Layer2 protocols on Gi 3/41
and Gi 3/42
02:28:04: %RPM0-P:CP %IFMGR-5-OSTATE_DN: Changed interface state to down: Gi 3/42
02:28:04: %RPM0-P:CP %IFMGR-5-STATE_ACT_STBY: Changed interface state to standby: Gi
3/42
```

Figure 28-7. CLI for Configuring Redundant Layer 2 Pairs without Spanning Tree

```

FTOS(conf-if-range-gi-3/41-42)#switchport backup interface GigabitEthernet 3/42
FTOS(conf-if-range-gi-3/41-42)#show config
!
interface GigabitEthernet 3/41
  no ip address
  switchport
  switchport backup interface GigabitEthernet 3/42
  no shutdown
!
interface GigabitEthernet 3/42
  no ip address
  switchport
  no shutdown
FTOS(conf-if-range-gi-3/41-42)#
FTOS(conf-if-range-gi-3/41-42)#do show ip int brief | find 3/41
GigabitEthernet 3/41      unassigned      YES Manual up          up
GigabitEthernet 3/42      unassigned      NO  Manual up          down
[output omitted]
FTOS(conf-if-range-gi-3/41-42)#interface gig 3/41
FTOS(conf-if-gi-3/41)#shutdown
00:24:53: %RPM0-P:CP %IFMGR-5-ASTATE_DN: Changed interface Admin state to down: Gi 3/41
FTOS(conf-if-gi-3/41)#00:24:55: %RPM0-P:CP %IFMGR-5-OSTATE_DN: Changed interface state to
down: Gi 3/41
00:24:55: %RPM0-P:CP %IFMGR-5-INACTIVE: Changed Vlan interface state to inactive: Vl 1
00:24:55: %RPM0-P:CP %IFMGR-5-OSTATE_UP: Changed interface state to up: Gi 3/42
00:24:55: %RPM0-P:CP %IFMGR-5-ACTIVE: Changed Vlan interface state to active: Vl 1
00:24:55: %RPM0-P:CP %IFMGR-5-STATE_STBY_ACT: Changed interface state from standby to active:
Gi 3/42

FTOS(conf-if-gi-3/41)#do show ip int brief | find 3/41
GigabitEthernet 3/41      unassigned      NO  Manual administratively down down
GigabitEthernet 3/42      unassigned      YES Manual up          up
[output omitted]

```

Figure 28-8. CLI for Redundant Pair in Port-channel on S4810 (or S4820T)

```

FTOS#show interfaces port-channel brief
Codes: L - LACP Port-channel

LAG Mode Status Uptime Ports
1 L2 up 00:08:33 Te 0/0 (Up)
2 L2 up 00:00:02 Te 0/1 (Up)
FTOS#configure
FTOS(conf)#interface port-channel 1
FTOS(conf-if-po-1)#switchport backup interface port-channel 2
Apr 9 00:15:13: %STKUNIT0-M:CP %IFMGR-5-L2BKUP_WARN: Do not run any Layer2 protocols on Po 1 and Po 2
Apr 9 00:15:13: %STKUNIT0-M:CP %IFMGR-5-OSTATE_DN: Changed interface state to down: Po 2
Apr 9 00:15:13: %STKUNIT0-M:CP %IFMGR-5-STATE_ACT_STBY: Changed interface state to standby: Po 2
FTOS(conf-if-po-1)#
FTOS#
FTOS#show interfaces switchport backup
Interface Status Paired Interface Status
Port-channel 1 Active Port-channel 2 Standby
Port-channel 2 Standby Port-channel 1 Active
FTOS#

FTOS(conf-if-po-1)#switchport backup interface tengigabitethernet 0/2
Apr 9 00:16:29: %STKUNIT0-M:CP %IFMGR-5-L2BKUP_WARN: Do not run any Layer2 protocols on Po 1 and Te 0/2
FTOS(conf-if-po-1)#

```

Restricting Layer 2 Flooding

Restricting Layer 2 Flooding is supported only on platform: 

When Layer 2 multicast traffic must be forwarded on a VLAN that has multiple ports with different speeds on the same port-pipe, forwarding is limited to the speed of the slowest port. Restricted Layer 2 Flooding prevents slower ports from lowering the throughput of multicast traffic on faster ports by restricting flooding to ports with a speed equal to or above a link speed you specify.

For example, if a VLAN that has an (auto-negotiated) 100M port and a 1G port on the same port-pipe, and you enable Restricted Layer 2 Flooding with a minimum speed of 1G, multicast traffic is only flooded on the 1G port.

Enable Restricted Layer 2 Flooding using the command **restrict-flooding** from INTERFACE VLAN mode.

In combination with **restrict-flooding**, you can use the command **mac-flood-list** from CONFIGURATION mode, without the **min-speed** option, to allow some specific multicast traffic (identified using a MAC address range you specify) to be flooded on all ports regardless of the **restrict-flooding** configuration.





Conversely, if you want all multicast traffic to be flooded on all ports, but some specific traffic to be restricted, use **mac-flood-list** with the **min-speed** option, but without **restrict-flooding** configured. This configuration restricts flooding only for traffic with destination multicast MAC addresses within the multicast MAC address range you specify.

In the following example, flooding of unknown multicast traffic is restricted to 1G ports on VLAN100 using the command **restrict-flooding**. However, the command **mac-flood-list** allows traffic with MAC addresses 01:01:e8:00:00:00 to 01:01:e8:ff:ff:ff to be flooded on all ports regardless of link speed.

Figure 28-9. Restricting Layer 2 Multicast Flooding over Low Speed Ports

```
FTOS(conf)#$1:01:e8:00:00:00 ff:ff:ff:00:00:00 vlan 100-200,300
FTOS#show run | find mac-flood-list
mac-flood-list 01:01:e8:00:00:00 ff:ff:ff:00:00:00 vlan 100-200,300
[output omitted]
FTOS(conf)#interface vlan 100
FTOS(conf-if-vl-100)#restrict-flooding multicast min-speed 1000
FTOS(conf-if-vl-100)#show config
!
interface Vlan 100
restrict-flooding multicast min-speed 1000
no shutdown
FTOS(conf-if-vl-100)#
```

Far-end Failure Detection

Far-end Failure Detection is supported on platforms    

Far-end Failure Detection (FEFD) is a protocol that senses remote data link errors in a network. It responds by sending a unidirectional report that triggers an echoed response after a specified time interval. FEFD can be enabled globally or locally on an interface basis. Disabling the global FEFD configuration does not disable the interface configuration.

Figure 28-10. Configuring Far-end Failure Detection

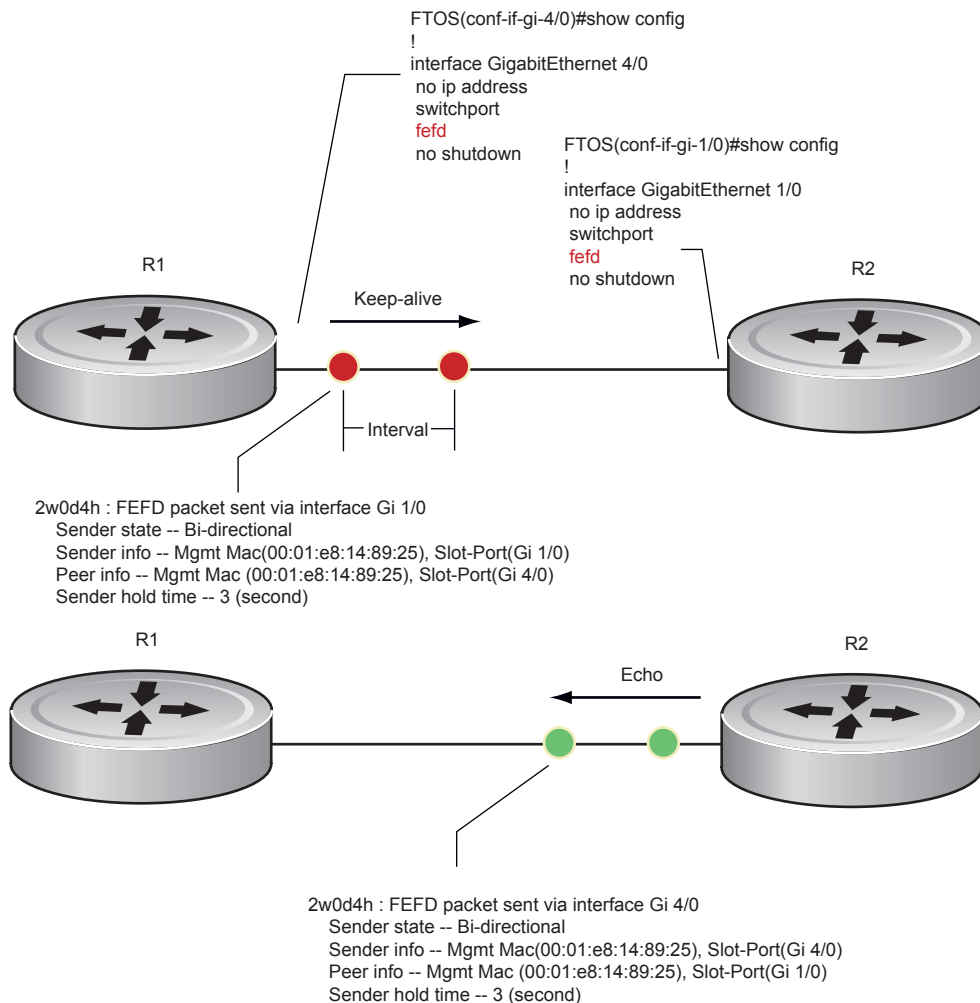

Layer2 001

The report consists of several packets in SNAP format that are sent to the nearest known MAC address.

In the event of a far-end failure, the device stops receiving frames, and after the specified time interval, assumes that the far-end is not available. The connecting line protocol is brought down so that upper layer protocols can detect the neighbor unavailability faster.

FEFD state changes

FEFD has two operational modes, Normal and Aggressive. When Normal mode is enabled on an interface on a far-end failure is detected, no intervention is required to reset the interface to bring it back to an FEFD operational state. When Aggressive mode is enabled on an interface in the same state, manual intervention is required to reset the interface.

FEFD enabled systems (comprised of one or more interfaces) will automatically switch between four different states: Idle, Unknown, Bi-directional, and Err-disabled.

1. An interface on which FEFD is not configured is in Normal mode by default.
2. Once FEFD is enabled on an interface, it transitions to the Unknown state and sends an FEFD packet to the remote end of the link.
3. When the local interface receives the echoed packet from the remote end, the local interface transitions to the Bi-directional state.
4. If the FEFD enabled system is configured to use FEFD in Normal mode and neighboring echoes are not received after three intervals, (each interval can be set between 3 and 300 seconds by the user) the state changes to unknown.
5. If the FEFD system has been set to Aggressive mode and neighboring echoes are not received after three intervals, the state changes to Err-disabled. All interfaces in the Err-disabled state must be manually reset using the **fefd reset [interface]** command in EXEC privilege mode (it can be done globally or one interface at a time) before the FEFD enabled system can become operational again.

Table 28-1. State Changes When Configuring FEFD

| Local Event | Mode | Local State | Remote State | Local Admin Status | Local Protocol Status | Remote Admin Status | Remote Protocol Status |
|---------------------|------------|------------------|----------------|--------------------|-----------------------|---------------------|------------------------|
| Shutdown | Normal | Admin Shutdown | Unknown | Down | Down | Up | Down |
| Shutdown | Aggressive | Admin Shutdown | Err-disabled | Up | Down | Up | Down |
| FEFD enable | Normal | Bi-directional | Bi-directional | Up | Up | Up | Up |
| FEFD enable | Aggressive | Bi-directional | Bi-directional | Up | Up | Up | Up |
| FEFD + FEFD disable | Normal | Locally disabled | Unknown | Up | Down | Up | Down |
| FEFD + FEFD disable | Aggressive | Locally disabled | Err-disabled | Up | Down | Up | Down |
| Link Failure | Normal | Unknown | Unknown | Up | Down | Up | Down |
| Link Failure | Aggressive | Err-disabled | Err-disabled | Up | Down | Up | Down |

Important Points to Remember

- FEFD enabled ports are subject to an 8 to 10 second delay during an RPM failover before becoming operational.
- FEFD can be enabled globally or on a per interface basis. Interface FEFD configurations override global FEFD configurations.
- FTOS supports FEFD on physical Ethernet interfaces only, excluding the management interface.

Configuring FEFD

You can configure FEFD for all interfaces from CONFIGURATION mode, or on individual interfaces from INTERFACE mode.

Enable FEFD Globally

To enable FEFD globally on all interfaces enter the command **fefd-global** in CONFIGURATION mode.

Report interval frequency and mode adjustments can be made by supplementing this command as well.

| Step | Task | Command Syntax | Command Mode |
|------|---|--|---------------|
| 1 | Setup two or more connected interfaces for Layer 2 or Layer 3 use | ip address ip address, switchport | INTERFACE |
| 2 | Activate the necessary ports administratively | no shutdown | INTERFACE |
| 3 | Enable fefd globally | fefd {interval mode} | CONFIGURATION |

Entering the **show fefd** command in EXEC privilege mode displays information about the state of each interface.

Figure 28-11. Show FEFD global outputs

```
FTOS#show fefd
FEFD is globally 'ON', interval is 3 seconds, mode is 'Normal'.

INTERFACE      MODE      INTERVAL      STATE
              (second)
Gi 1/0         Normal    3             Bi-directional
Gi 1/1         Normal    3             Admin Shutdown
Gi 1/2         Normal    3             Admin Shutdown
Gi 1/3         Normal    3             Admin Shutdown

FTOS#show run fefd
!
fefd-global mode normal
fefd-global interval 3
```

Enable FEFD on an Interface

Entering the command **fefd** in INTERFACE mode enables FEFD on a per interface basis. To change the FEFD mode, supplement the **fefd** command in INTERFACE mode by entering the command **fefd [mode {aggressive | normal}]**.

To disable FEFD protocol on one interface, enter the command **fefd disable** in INTERFACE mode. Disabling an interface will shut down all protocols working on that interface's connected line, and will not delete your previous FEFD configuration which can be enabled again at any time.

| Step | Task | Command Syntax | Command Mode |
|------|---|---|--------------|
| 1 | Setup two or more connected interfaces for Layer 2 or Layer 3 use | ip address <i>ip address, switchport</i> | INTERFACE |
| 2 | Activate the necessary ports administratively | no shutdown | INTERFACE |
| 3 | Enable FEFD on each interface | fefd {disable interval mode} | INTERFACE |

Figure 28-12. FEFD enabled interface configuration

```
FTOS(conf-if-gi-1/0)#show config
!
interface GigabitEthernet 1/0
  no ip address
  switchport
  fefd mode normal
  no shutdown

FTOS(conf-if-gi-1/0)#do show fefd | grep 1/0
Gi 1/0          Normal          3          Unknown
```

Debugging FEFD

By entering the command **debug fefd events** in EXEC privilege mode, output is displayed whenever events occur that initiate or disrupt an FEFD enabled connection.

Figure 28-13. Debug FEFD events display

```

FTOS#debug fefd events
FTOS#config
FTOS(conf)#int gi 1/0
FTOS(conf-if-gi-1/0)#shutdown
2w1d22h: %RPM0-P:CP %IFMGR-5-ASTATE_DN: Changed interface Admin state to down: Gi 1/0
FTOS(conf-if-gi-1/0)#2w1d22h : FEFD state on Gi 1/0 changed from ANY to Unknown
2w1d22h: %RPM0-P:CP %IFMGR-5-OSTATE_DN: Changed interface state to down: Gi 1/0
2w1d22h: %RPM0-P:CP %IFMGR-5-OSTATE_DN: Changed interface state to down: Gi 4/0
2w1d22h: %RPM0-P:CP %IFMGR-5-INACTIVE: Changed Vlan interface state to inactive: Vl 1
2w1d22h : FEFD state on Gi 4/0 changed from Bi-directional to Unknown

```

Entering the command **debug fefd packets** in EXEC privilege mode will provide output for each packet transmission over the FEFD enabled connection.

Figure 28-14. Debug FEFD packets display

```

FTOS#debug fefd packets
FTOS#2w1d22h : FEFD packet sent via interface Gi 1/0
  Sender state -- Bi-directional
  Sender info -- Mgmt Mac (00:01:e8:14:89:25), Slot-Port(Gi 1/0)
  Peer info -- Mgmt Mac (00:01:e8:14:89:25), Slot-Port(Gi 4/0)
  Sender hold time -- 3 (second)

2w1d22h : FEFD packet received on interface Gi 4/0
  Sender state -- Bi-directional
  Sender info -- Mgmt Mac(00:01:e8:14:89:25), Slot-Port(Gi 1/0)
  Peer info -- Mgmt Mac (00:01:e8:14:89:25), Slot-Port(Gi 4/0)
  Sender hold time -- 3 (second)

```

During an RPM Failover

In the event that an RPM failover occurs, FEFD will become operationally down on all enabled ports for approximately 8-10 seconds before automatically becoming operational again.

Figure 28-15. FEFD state change during an RPM failover

```

02-05-2009      12:40:38      Local7.Debug      10.16.151.12      Feb 5 07:06:09:
%RPM1-S:CP %RAM-6-FAILOVER_REQ: RPM failover request from active peer: User request.
02-05-2009      12:40:38      Local7.Debug      10.16.151.12      Feb 5 07:06:19:
%RPM1-P:CP %IFMGR-5-OSTATE_UP: Changed interface state to up: Gi 0/45
02-05-2009      12:40:38      Local7.Debug      10.16.151.12      Feb 5 07:06:19:
%RPM1-P:CP %FEFD-5-FEFD-BIDIRECTION-LINK-DETECTED: Interface Gi 0/45 has bidirectional link with its
peer

```

Link Layer Discovery Protocol (LLDP)

Link Layer Discovery Protocol (LLDP) is supported only on platforms: e C S **S4810**

S4820T

This chapter contains the following sections:

- [802.1AB \(LLDP\) Overview](#)
- [TIA-1057 \(LLDP-MED\) Overview](#)
- [Configuring LLDP](#)

802.1AB (LLDP) Overview

Link Layer Discovery Protocol (LLDP)—defined by IEEE 802.1AB—is a protocol that enables a LAN device to advertise its configuration and receive configuration information from adjacent LLDP-enabled LAN infrastructure devices. The collected information is stored in a management information base (MIB) on each device, and is accessible via SNMP.

Protocol Data Units

Configuration information is exchanged in the form of Type, Length, Value (TLV) segments. [Figure 29-1](#) shows the Chassis ID TLV.

- **Type**—The kind of information included in the TLV
- **Length**—The value, in octets, of the TLV after the Length field
- **Value**—The configuration information that the agent is advertising

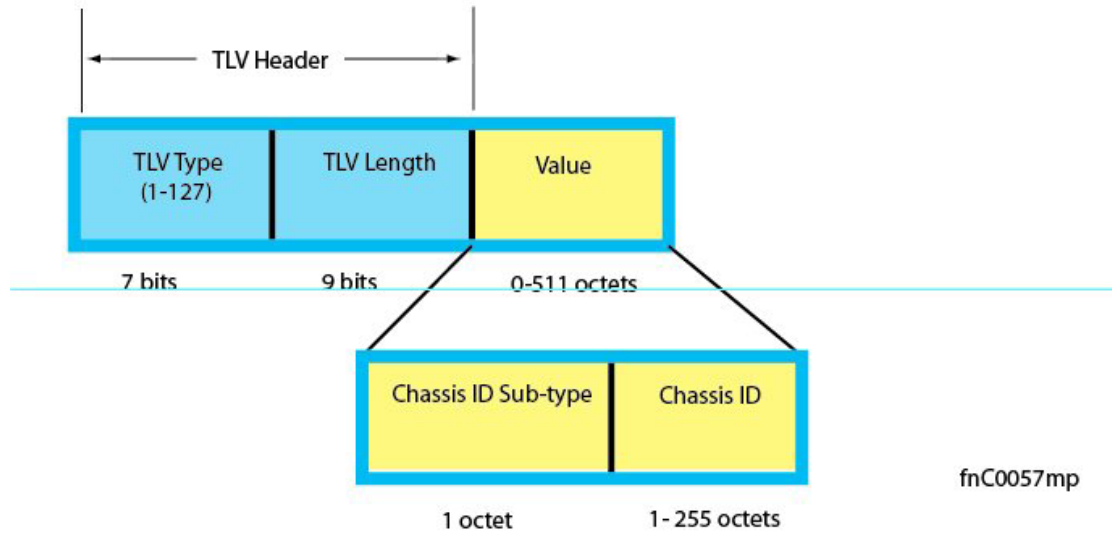
Figure 29-1. Type, Length, Value (TLV) Segment

TLVs are encapsulated in a frame called an LLDP Data Unit (LLDPDU) (Figure 29-2), which is transmitted from one LLDP-enabled device to its LLDP-enabled neighbors. LLDP is a one-way protocol. LLDP-enabled devices (LLDP agents) can transmit and/or receive advertisements, but they cannot solicit and do not respond to advertisements.

There are five types of TLVs. All types are mandatory in the construction of an LLDPDU except Optional TLVs. The inclusion of individual Optional TLVs is user configurable.

Table 29-1. Type, Length, Value (TLV) Types

| Type | TLV | Description |
|------|---------------|---|
| 0 | End of LLDPDU | Marks the end of an LLDPDU |
| 1 | Chassis ID | An administratively assigned name that identifies the LLDP agent |
| 2 | Port ID | An administratively assigned name that identifies a port through which TLVs are sent and received |
| 3 | Time to Live | A value that tells the receiving agent how long the information contained in the TLV Value field is valid |
| — | Optional | Includes sub-types of TLVs that advertise specific configuration information. These sub-types are Management TLVs, IEEE 802.1, IEEE 802.3, and TIA-1057 Organizationally Specific TLVs. |

Figure 29-2. LLDPDU Frame

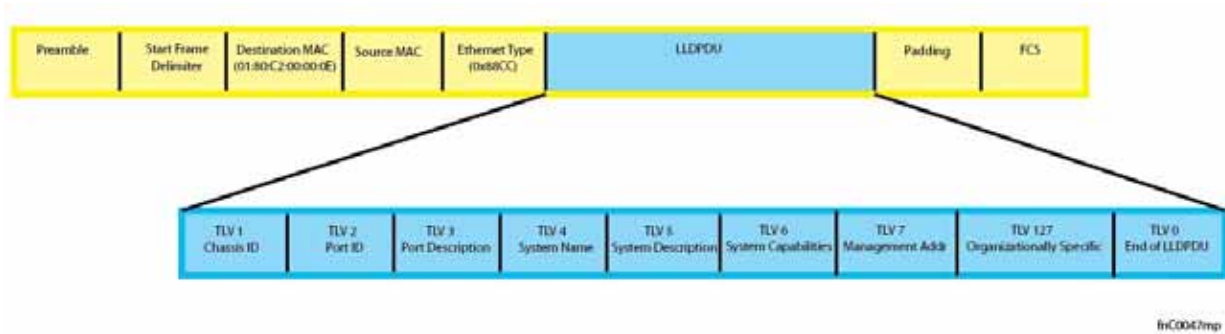

fnC0047mp

Optional TLVs

FTOS supports the following optional TLVs:

- Management TLVs
- IEEE 802.1 and 802.3 Organizationally Specific TLVs
- TIA-1057 Organizationally Specific TLVs

Management TLVs

A Management TLV is an Optional TLVs sub-type. This kind of TLV contains essential management information about the sender. The five types are described in [Table 29-2](#).

Organizationally Specific TLVs

Organizationally specific TLVs can be defined by a professional organization or a vendor. They have two mandatory fields ([Figure 29-3](#)) in addition to the basic TLV fields ([Figure 29-1](#)):

- Organizationally Unique Identifier (OUI)—a unique number assigned by the IEEE to an organization or vendor.
- OUI Sub-type—These sub-types indicate the kind of information in the following data field. The sub-types are determined by the owner of the OUI.

Figure 29-3. Organizationally Specific TLV

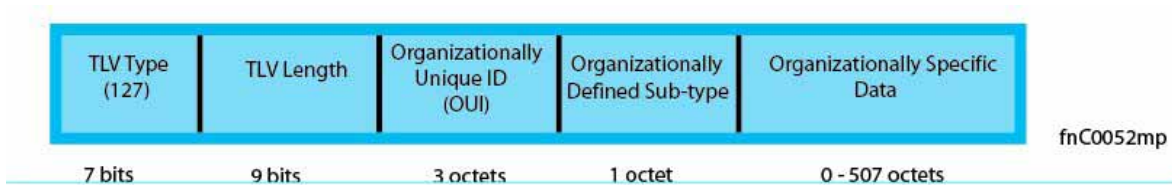

fnC0052mp

IEEE Organizationally Specific TLVs

Eight TLV types have been defined by the IEEE 802.1 and 802.3 working groups (Table 29-2) as a basic part of LLDP; the IEEE OUI is 00-80-C2. You can configure the Dell Force10 system to advertise any or all of these TLVs.

Table 29-2. Optional TLV Types

| Type | TLV | Description |
|--|------------------------------|--|
| Optional TLVs | | |
| 4 | Port description | A user-defined alphanumeric string that describes the port. FTOS does not currently support this TLV. |
| 5 | System name | A user-defined alphanumeric string that identifies the system. |
| 6 | System description | A user-defined alphanumeric string that describes the system |
| 7 | System capabilities | Identifies the chassis as one or more of the following: repeater, bridge, WLAN Access Point, Router, Telephone, DOCSIS cable device, end station only, or other |
| 8 | Management address | Indicates the network address of the management interface. FTOS does not currently support this TLV. |
| IEEE 802.1 Organizationally Specific TLVs | | |
| 127 | Port-VLAN ID | On Dell Force10 systems, indicates the untagged VLAN to which a port belongs |
| 127 | Port and Protocol VLAN ID | On Dell Force10 systems, indicates the tagged VLAN to which a port belongs (and the untagged VLAN to which a port belongs if the port is in hybrid mode) |
| 127 | VLAN Name | Indicates the user-defined alphanumeric string that identifies the VLAN. This TLV is supported on C-Series only. |
| 127 | Protocol Identity | Indicates the protocols that the port can process. FTOS does not currently support this TLV. |
| IEEE 802.3 Organizationally Specific TLVs | | |
| 127 | MAC/PHY Configuration/Status | Indicates the capability and current setting of the duplex status and bit rate, and whether the current settings are the result of auto-negotiation. This TLV is not available in the FTOS implementation of LLDP, but is available and mandatory (non-configurable) in the LLDP-MED implementation. |
| 127 | Power via MDI | Dell Force10 supports LLDP-MED protocol, which recommends that Power via MDI TLV be not implemented, and therefore Dell Force10 implements Extended Power via MDI TLV only. |
| 127 | Link Aggregation | Indicates whether the link is capable of being aggregated, whether it is currently in a LAG, and the port identification of the LAG. FTOS does not currently support this TLV. |
| 127 | Maximum Frame Size | Indicates the maximum frame size capability of the MAC and PHY |

TIA-1057 (LLDP-MED) Overview

Link Layer Discovery Protocol—Media Endpoint Discovery (LLDP-MED) as defined by ANSI/TIA-1057— provides additional organizationally specific TLVs so that endpoint devices and network connectivity devices can advertise their characteristics and configuration information; the OUI for the Telecommunications Industry Association (TIA) is 00-12-BB.

- **LLDP-MED Endpoint Device**—any device that is on an IEEE 802 LAN network edge can communicate using IP and uses the LLDP-MED framework.
- **LLDP-MED Network Connectivity Device**—any device that provides access to an IEEE 802 LAN to an LLDP-MED endpoint device and supports IEEE 802.1AB (LLDP) and TIA-1057 (LLDP-MED). The Dell Force10 system is an LLDP-MED network connectivity device.

With regard to connected endpoint devices, LLDP-MED provides network connectivity devices with the ability to:

- manage inventory
- manage Power over Ethernet (PoE)
- identify physical location
- identify network policy

LLDP-MED is designed for, but not limited to, VoIP endpoints.

TIA Organizationally Specific TLVs

The Dell Force10 system is an LLDP-MED Network Connectivity Device (Device Type 4). Network connectivity devices are responsible for:

- transmitting an LLDP-MED capabilities TLV to endpoint devices
- storing the information that endpoint devices advertise

[Table 29-3](#) describes the five types of TIA-1057 Organizationally Specific TLVs.

Table 29-3. TIA-1057 (LLDP-MED) Organizationally Specific TLVs

| Type | Sub-type | TLV | Description |
|----------------------------------|----------|-------------------------------|---|
| 127 | 1 | LLDP-MED Capabilities | Indicates: <ul style="list-style-type: none"> • whether the transmitting device supports LLDP-MED • what LLDP-MED TLVs it supports • LLDP device class |
| 127 | 2 | Network Policy | Indicates the application type, VLAN ID, Layer 2 Priority, and DSCP value |
| 127 | 3 | Location Identification | Indicates the physical location of the device expressed in one of three possible formats: <ul style="list-style-type: none"> • Coordinate Based LCI • Civic Address LCI • Emergency Call Services ELIN |
| 127 | 4 | Extended Power via MDI | Indicates power requirements, priority, and power status |
| Inventory Management TLVs | | | Implementation of this set of TLVs is optional in LLDP-MED devices. None or all TLVs must be supported. FTOS does not currently support these TLVs. |
| 127 | 5 | Inventory - Hardware Revision | Indicates the hardware revision of the LLDP-MED device |
| 127 | 6 | Inventory - Firmware Revision | Indicates the firmware revision of the LLDP-MED device |
| 127 | 7 | Inventory - Software Revision | Indicates the software revision of the LLDP-MED device |
| 127 | 8 | Inventory - Serial Number | Indicates the device serial number of the LLDP-MED device |
| 127 | 9 | Inventory - Manufacturer Name | Indicates the manufacturer of the LLDP-MED device |
| 127 | 10 | Inventory - Model Name | Indicates the model of the LLDP-MED device |
| 127 | 11 | Inventory - Asset ID | Indicates a user specified device number to manage inventory |
| 127 | 12-255 | Reserved | — |

LLDP-MED Capabilities TLV

The LLDP-MED Capabilities TLV communicates the types of TLVs that the endpoint device and the network connectivity device support. LLDP-MED network connectivity devices must transmit the Network Policies TLV.

- The value of the LLDP-MED Capabilities field in the TLV is a 2 octet bitmap ([Figure 29-4](#)), each bit represents an LLDP-MED capability ([Table 29-4](#)).
- The possible values of the LLDP-MED Device Type is listed in [Table 29-5](#). The Dell Force10 system is a Network Connectivity device, which is Type 4.

When you enable LLDP-MED in FTOS (using the command `advertise med`) the system begins transmitting this TLV.

Figure 29-4. LLDP-MED Capabilities TLV

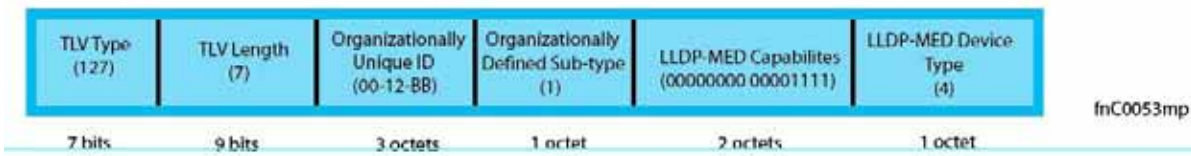

Table 29-4. FTOS LLDP-MED Capabilities

| Bit Position | TLV | FTOS Support |
|--------------|----------------------------|--------------|
| 0 | LLDP-MED Capabilities | Yes |
| 1 | Network Policy | Yes |
| 2 | Location Identification | Yes |
| 3 | Extended Power via MDI-PSE | Yes |
| 4 | Extended Power via MDI-PD | No |
| 5 | Inventory | No |
| 6-15 | reserved | No |

Table 29-5. LLDP-MED Device Types

| Value | Device Type |
|-------|----------------------|
| 0 | Type Not Defined |
| 1 | Endpoint Class 1 |
| 2 | Endpoint Class 2 |
| 3 | Endpoint Class 3 |
| 4 | Network Connectivity |
| 5-255 | Reserved |

LLDP-MED Network Policies TLV

A network policy in the context of LLDP-MED is a device’s VLAN configuration and associated Layer 2 and Layer 3 configurations, specifically:

- VLAN ID
- VLAN tagged or untagged status
- Layer 2 priority
- DSCP value

The application type is represented by an integer (the Type integer in [Table 29-6](#)), which indicates a device function for which a unique network policy is defined. An individual LLDP-MED Network Policy TLV is generated for each application type that you specify with the FTOS CLI ([Advertising TLVs on page 618](#)).



Note: With regard to [Table 29-6](#), signaling is a series of control packets that are exchanged between an endpoint device and a network connectivity device to establish and maintain a connection. These signal packets might require a different network policy than the media packets for which a connection is made. In this case, configure the signaling application.

Table 29-6. Network Policy Applications

| Type | Application | Description |
|-------|-----------------------|---|
| 0 | Reserved | — |
| 1 | Voice | Specify this application type for dedicated IP telephony handsets and other appliances supporting interactive voice services. |
| 2 | Voice Signaling | Specify this application type only if voice control packets use a separate network policy than voice data. |
| 3 | Guest Voice | Specify this application type for a separate limited voice service for guest users with their own IP telephony handsets and other appliances supporting interactive voice services. |
| 4 | Guest Voice Signaling | Specify this application type only if guest voice control packets use a separate network policy than voice data. |
| 5 | Softphone Voice | Softphone is a computer program that enables IP telephony on a computer, rather than using a phone. Specify this application type for this type of endpoint device. |
| 6 | Video Conferencing | Specify this application type for dedicated video conferencing and other similar appliances supporting real-time interactive video. |
| 7 | Streaming Video | Specify this application type for broadcast or multicast based video content distribution and other similar applications supporting streaming video services. This does not include video applications relying on TCP with buffering. |
| 8 | Video Signaling | Specify this application type only if video control packets use a separate network policy than video data. |
| 9-255 | Reserved | — |

Figure 29-5. LLDP-MED Policies TLV

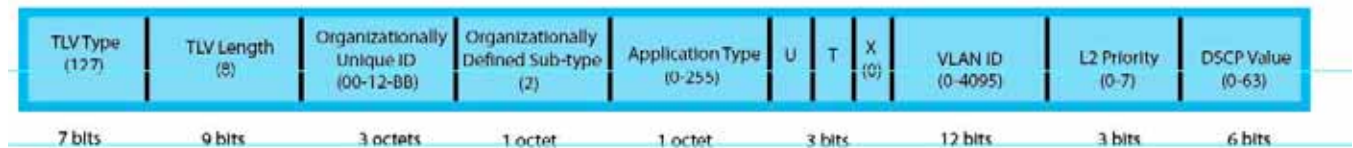

Extended Power via MDI TLV

The Extended Power via MDI TLV enables advanced PoE management between LLDP-MED endpoints and network connectivity devices. Advertise the Extended Power via MDI on all ports that are connected to an 802.3af powered, LLDP-MED endpoint device.

- **Power Type:** there are two possible power types: Power Sourcing Entity (PSE) or Power Device (PD). The Dell Force10 system is a PSE, which corresponds to a value of 0, based on the TIA-1057 specification.
- **Power Source:** there are two possible power sources: Primary and Backup. The Dell Force10 system is a Primary Power Source, which corresponds to a value of 1, based on the TIA-1057 specification.
- **Power Priority:** there are three possible priorities: Low, High, and Critical. On Dell Force10 systems, the default power priority is “High,” which corresponds to a value of 2 based on the TIA-1057 specification. You can configure a different power priority through the CLI, Dell Force10 also honors the power priority value sent by the powered device. However, the CLI configuration takes precedence.
- **Power Value:** Dell Force10 advertises the maximum amount of power that can be supplied on the port. By default it is 15.4W, which corresponds to a Power Value of 130, based on the TIA-1057 specification. You can advertise a different Power Value using the max-milliwatts option with the power inline auto | static command. Dell Force10 also honors the power value (power requirement) sent by the powered device when the port is configured for power inline auto.

Figure 29-6. Extended Power via MDI TLV



Configuring LLDP

Configuring LLDP is a two-step process:

1. Enable LLDP globally.
2. Advertise TLVs out of an interface.

Related Configuration Tasks

- [Viewing the LLDP Configuration](#)
- [Viewing Information Advertised by Adjacent LLDP Agents](#)
- [Configuring LLDPDU Intervals](#)
- [Configuring Transmit and Receive Mode](#)
- [Configuring a Time to Live](#)
- [Debugging LLDP](#)

Important Points to Remember

- LLDP is disabled by default.
- Dell Force10 systems support up to 8 neighbors per interface.
- Dell Force10 systems support a maximum of 8000 total neighbors per system. If the number of interfaces multiplied by 8 exceeds the maximum, the system will not configure more than 8000.
- INTERFACE level configurations override all CONFIGURATION level configurations.
- LLDP is not hitless.

LLDP Compatibility

- Spanning Tree and Force10 Ring Protocol “blocked” ports allow LLDPDUs.
- 802.1X controlled ports do not allow LLDPDUs until the connected device is authenticated.

CONFIGURATION versus INTERFACE Configurations

All LLDP configuration commands are available in PROTOCOL LLDP mode, which is a sub-mode of the CONFIGURATION mode and INTERFACE mode.

- Configurations made at the CONFIGURATION level are global, that is, they affect all interfaces on the system.
- Configurations made at the INTERFACE level affect only the specific interface, and they override CONFIGURATION level configurations.

Figure 29-7. Configuration and Interface mode LLDP Commands

```
R1(conf)#protocol lldp
R1(conf-lldp)#?
advertise          Advertise TLVs
disable           Disable LLDP protocol globally
end               Exit from configuration mode
exit              Exit from LLDP configuration mode
hello             LLDP hello configuration
mode              LLDP mode configuration (default = rx and tx)
multiplier        LLDP multiplier configuration
no                Negate a command or set its defaults
show              Show LLDP configuration
R1(conf-lldp)#exit
R1(conf)#interface gigabitethernet 1/31
R1(conf-if-gi-1/31)#protocol lldp
R1(conf-if-gi-1/31-lldp)#?
advertise          Advertise TLVs
disable           Disable LLDP protocol on this interface
end               Exit from configuration mode
exit              Exit from LLDP configuration mode
hello             LLDP hello configuration
mode              LLDP mode configuration (default = rx and tx)
multiplier        LLDP multiplier configuration
no                Negate a command or set its defaults
show              Show LLDP configuration
R1(conf-if-gi-1/31-lldp)#
```

Enabling LLDP

LLDP is disabled by default. LLDP can be enabled and disabled globally or per interface. If LLDP is enabled globally, all up interfaces send periodic LLDPDUs. To enable LLDP:

| Step | Task | Command | Command Mode |
|------|---------------------------|---------------|----------------------------|
| 1 | Enter Protocol LLDP mode. | protocol lldp | CONFIGURATION or INTERFACE |
| 2 | Enable LLDP. | no disable | PROTOCOL LLDP |

Disabling and Undoing LLDP

- Disable LLDP globally or for an interface using the command **disable**.
- Undo an LLDP configuration by preceding the relevant command with the keyword **no**.

Advertising TLVs

You can configure the system to advertise TLVs out of all interfaces or out of specific interfaces.

- If you configure the system globally, all interfaces will send LLDPDUs with the specified TLVs.
- If you configure an interface, only the interface will send LLDPDUs with the specified TLVs.

If LLDP is configured both globally and at interface level, the interface level configuration overrides the global configuration. To advertise TLVs:

| Step | Task | Command | Command Mode |
|------|---|---|----------------------------|
| 1 | Enter LLDP mode. | protocol lldp | CONFIGURATION or INTERFACE |
| 2 | Advertise one or more TLVs. Include the keyword for each TLV you want to advertise. <ul style="list-style-type: none"> • For management TLVs: system-capabilities, system-description For 802.1 TLVs: port-protocol-vlan-id , port-vlan-id , vlan-name <ul style="list-style-type: none"> • For 802.3 TLVs: max-frame-size • For TIA-1057 TLVs: <ul style="list-style-type: none"> • guest-voice • guest-voice-signaling • location-identification • power-via-mdi • softphone-voice • streaming-video • video-conferencing • video-signaling • voice • voice-signaling | advertise {management-tlv dot1-tlv dot3-tlv med} | PROTOCOL LLDP |

Note: The **vlan-name** command is supported on C-Series and S-Series only.

In [Figure 29-8](#), LLDP is enabled globally. R1 and R2 are transmitting periodic LLDPDUs that contain management, 802.1, and 802.3 TLVs.

Figure 29-8. Configuring LLDP

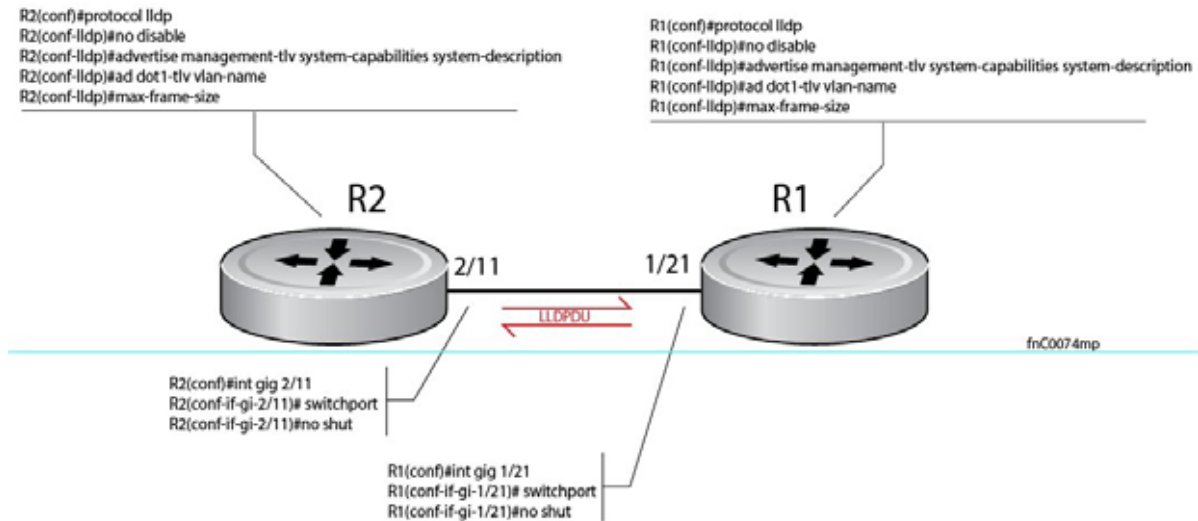

Viewing the LLDP Configuration

Display the LLDP configuration using the command **show config** in either the CONFIGURATION or INTERFACE mode, as shown in Figure 29-9 and Figure 29-10, respectively.

Figure 29-9. Viewing LLDP Global Configurations

```
R1(conf)#protocol lldp
R1(conf-lldp)#show config
!
protocol lldp
 advertise dot1-tlv port-protocol-vlan-id port-vlan-id
 advertise dot3-tlv max-frame-size
 advertise management-tlv system-capabilities system-description
 hello 10
 no disable
R1(conf-lldp)#
```

Figure 29-10. Viewing LLDP Interface Configurations

```

R1(conf-lldp)#exit
R1(conf)#interface gigabitethernet 1/31
R1(conf-if-gi-1/31)#show config
!
interface GigabitEthernet 1/31
  no ip address
  switchport
  no shutdown
R1(conf-if-gi-1/31)#protocol lldp
R1(conf-if-gi-1/31-lldp)#show config
!
  protocol lldp
R1(conf-if-gi-1/31-lldp)#

```

Viewing Information Advertised by Adjacent LLDP Agents

Display brief information about adjacent devices using the command **show lldp neighbors**, as shown in [Figure 29-11](#). Display all of the information that neighbors are advertising using the command **show lldp neighbors detail**, as shown in [Figure 29-12](#).

Figure 29-11. Viewing Brief Information Advertised by Adjacent LLDP Agents

```

R1(conf-if-gi-1/31-lldp)#end
R1(conf-if-gi-1/31)#do show lldp neighbors
  Loc PortID   Rem Host Name           Rem Port Id           Rem Chassis Id
  -----
  Gi 1/21     -                       GigabitEthernet 2/11  00:01:e8:06:95:3e
  Gi 1/31     -                       GigabitEthernet 3/11  00:01:e8:09:c2:4a

```

Figure 29-12. Viewing All Information Advertised by Adjacent LLDP Agent

```
R1#show lldp neighbors detail
=====
Local Interface Gi 1/21 has 1 neighbor
Total Frames Out: 6547
Total Frames In: 4136
Total Neighbor information Age outs: 0
Total Frames Discarded: 0
Total In Error Frames: 0
Total Unrecognized TLVs: 0
Total TLVs Discarded: 0
Next packet will be sent after 7 seconds
The neighbors are given below:
-----

Remote Chassis ID Subtype: Mac address (4)
Remote Chassis ID: 00:01:e8:06:95:3e
Remote Port Subtype: Interface name (5)
Remote Port ID: GigabitEthernet 2/11
Local Port ID: GigabitEthernet 1/21
Locally assigned remote Neighbor Index: 4
Remote TTL: 120
Information valid for next 120 seconds
Time since last information change of this neighbor: 01:50:16
Remote MTU: 1554
Remote System Desc: Dell Force10 Networks Real Time Operating System Software
. Dell Force10 Operating System Version: 1.0. Dell Force10 App
lication Software Version: 7.5.1.0. Copyright (c) 19
99-Build Time: Thu Aug 9 01:05:51 PDT 2007
Existing System Capabilities: Repeater Bridge Router
Enabled System Capabilities: Repeater Bridge Router
Remote Port Vlan ID: 1
Port and Protocol Vlan ID: 1, Capability: Supported, Status: Enabled
-----

=====
```

Configuring LLDPDU Intervals

LLDPDUs are transmitted periodically; the default interval is 30 seconds. You can configure a non-default transmit interval—at CONFIGURATION level or INTERFACE level—using the **hello** command (Figure 29-13).

Figure 29-13. Configuring LLDPDU Transmit and Receive Mode

```

R1(conf)#protocol lldp
R1(conf-lldp)#show config
!
protocol lldp
  advertise dot1-tlv port-protocol-vlan-id port-vlan-id
  advertise dot3-tlv max-frame-size
  advertise management-tlv system-capabilities system-description
  no disable
R1(conf-lldp)#mode ?
rx                Rx only
tx                Tx only
R1(conf-lldp)#mode tx
R1(conf-lldp)#show config
!
protocol lldp
  advertise dot1-tlv port-protocol-vlan-id port-vlan-id
  advertise dot3-tlv max-frame-size
  advertise management-tlv system-capabilities system-description
  mode tx
  no disable
R1(conf-lldp)#no mode
R1(conf-lldp)#show config
!
protocol lldp
  advertise dot1-tlv port-protocol-vlan-id port-vlan-id
  advertise dot3-tlv max-frame-size
  advertise management-tlv system-capabilities system-description
  no disable
R1(conf-lldp)#

```

Configuring Transmit and Receive Mode

Once LLDP is enabled, Dell Force10 systems transmit *and* receive LLDPDUs by default. You can configure the system—at CONFIGURATION level or INTERFACE level—to transmit only by executing the command **mode tx**, or receive only by executing the command **mode rx**. Return to the default with the **no mode** command (Figure 29-14).

Figure 29-14. Configuring LLDPDU Transmit and Receive Mode

```
R1(conf)#protocol lldp
R1(conf-lldp)#show config
!
protocol lldp
  advertise dot1-tlv port-protocol-vlan-id port-vlan-id
  advertise dot3-tlv max-frame-size
  advertise management-tlv system-capabilities system-description
  no disable
R1(conf-lldp)#mode ?
rx                Rx only
tx                Tx only
R1(conf-lldp)#mode tx
R1(conf-lldp)#show config
!
protocol lldp
  advertise dot1-tlv port-protocol-vlan-id port-vlan-id
  advertise dot3-tlv max-frame-size
  advertise management-tlv system-capabilities system-description
  mode tx
  no disable
R1(conf-lldp)#no mode
R1(conf-lldp)#show config
!
protocol lldp
  advertise dot1-tlv port-protocol-vlan-id port-vlan-id
  advertise dot3-tlv max-frame-size
  advertise management-tlv system-capabilities system-description
  no disable
R1(conf-lldp)#
```

Configuring a Time to Live

The information received from a neighbor expires after a specific amount of time (measured in seconds) called a Time to Live (TTL). The TTL is the product of the LLDPDU transmit interval (hello) and an integer called a *multiplier*. The default multiplier is 4, which results in a default TTL of 120 seconds. Adjust the TTL value—at CONFIGURATION level or INTERFACE level—using the **multiplier** command. Return to the default multiplier value using the **no multiplier** command (Figure 29-15).

Figure 29-15. Configuring LLDPDU Time to Live

```

R1(conf-lldp)#show config
!
protocol lldp
  advertise dot1-tlv port-protocol-vlan-id port-vlan-id
  advertise dot3-tlv max-frame-size
  advertise management-tlv system-capabilities system-description
  no disable
R1(conf-lldp)#multiplier ?
<2-10>                Multiplier (default=4)
R1(conf-lldp)#multiplier 5
R1(conf-lldp)#show config
!
protocol lldp
  advertise dot1-tlv port-protocol-vlan-id port-vlan-id
  advertise dot3-tlv max-frame-size
  advertise management-tlv system-capabilities system-description
multiplier 5
  no disable
R1(conf-lldp)#no multiplier
R1(conf-lldp)#show config
!
protocol lldp
  advertise dot1-tlv port-protocol-vlan-id port-vlan-id
  advertise dot3-tlv max-frame-size
  advertise management-tlv system-capabilities system-description
  no disable
R1(conf-lldp)#

```

Debugging LLDP

The command `debug lldp` enables you to view the TLVs that your system is sending and receiving.

- Use the `debug lldp brief` command to view a readable version of the TLVs.
- Use the `debug lldp detail` command to view a readable version of the TLVs plus a hexadecimal version of the entire LLDPDU.

Figure 29-16. debug lldp detail—LLDPDU Packet Dissection

```

FTOS# debug lldp interface gigabitethernet 1/2 packet detail tx
FTOS#1w1d19h : Transmit timer blew off for local interface Gi 1/2
1w1d19h : Forming LLDP pkt to send out of interface Gi 1/2
1w1d19h : TLV: Chassis ID, Len: 7, Subtype: Mac address (4), Value: 00:01:e8:0d:b6:d6
1w1d19h : TLV: Port ID, Len: 20, Subtype: Interface name (5), Value: GigabitEthernet 1/2
1w1d19h : TLV: TTL, Len: 2, Value: 120
1w1d19h : TLV: SYS_DESC, Len: 207, Value: Dell Force10 Networks Real Time Operating System Software. Dell Force10
Operating System Version: 1.0. Dell Force10 Application Software Version: 8.3.11.4. Copyright (c)1999-2011 Dell Inc.
Time: Fri Oct 26 12:22:22 PDT 2007
1w1d19h : TLV: SYSTEM_CAPAB, Len: 4, Value: Existing: Repeater Bridge Router, Enabled: Repeater Bridge Router
1w1d19h : TLV: ENDOFPDU, Len: 0
1w1d19h : Sending LLDP pkt out of Gi 1/2 of length 270
1w1d19h : Packet dump:
1w1d19h : 01 80 c2 00 00 0a 00 01 e8 0d b7 3b 81 00 00 00 Source Address (LLDP Multicast)
1w1d19h : 88 cc 02 07 04 00 01 e8 0d b6 d6 04 14 05 47 69 Dell Force10 System Chassis ID
1w1d19h : 67 61 62 69 74 45 74 68 65 72 6e 65 74 20 31 2f 802.1Q Header
1w1d19h : 32 06 02 00 78 0c cf 46 6f 72 63 65 31 30 20 4e
1w1d19h : 65 74 77 6f 72 6b 73 20 52 65 61 6c 20 54 69 6d
1w1d19h : 65 20 4f 70 65 72 61 74 69 6e 67 20 53 79 73 74
1w1d19h : 65 6d 20 53 6f 66 74 77 61 72 65 2e 20 46 6f 72
1w1d19h : 63 65 31 30 20 4f 70 65 72 61 74 69 6e 67 20 53
1w1d19h : 79 73 74 65 6d 20 56 65 72 73 69 6f 6e 3a 20 31
1w1d19h : 2e 30 2e 20 46 6f 72 63 65 31 30 20 41 70 70 6c
1w1d19h : 69 63 61 74 69 6f 6e 20 53 6f 66 74 77 61 72 65
1w1d19h : 20 56 65 72 73 69 6f 6e 3a 20 45 5f 4d 41 49 4e
1w1d19h : 34 2e 37 2e 35 2e 32 37 36 2e 20 43 6f 70 79 72
1w1d19h : 69 67 68 74 20 28 63 29 20 31 39 39 39 2d 42 75
1w1d19h : 69 6c 64 20 54 69 6d 65 3a 20 46 72 69 20 4f 63
1w1d19h : 74 20 32 36 20 31 32 3a 32 32 3a 32 32 20 50 44
1w1d19h : 54 20 32 30 30 37 0e 04 00 16 00 16 00 00
1w1d19h : LLDP frame sent out successfully of Gi 1/2
1w1d19h : Started Transmit timer for Loc interface Gi 1/2 for time 30 sec

```

fnC0051mp

Relevant Management Objects

FTOS supports all IEEE 802.1AB MIB objects.

- [Table 29-7](#) lists the objects associated with received and transmitted TLVs.
- [Table 29-8](#) lists the objects associated with the LLDP configuration on the local agent.
- [Table 29-9](#) lists the objects associated with IEEE 802.1AB Organizationally Specific TLVs.
- [Table 29-10](#) lists the objects associated with received and transmitted LLDP-MED TLVs.

Table 29-7. LLDP Configuration MIB Objects

| MIB Object Category | LLDP Variable | LLDP MIB Object | Description |
|----------------------------|-----------------------------|--------------------------------------|--|
| LLDP Configuration | adminStatus | lldpPortConfigAdminStatus | Whether the local LLDP agent is enabled for transmit, receive, or both |
| | msgTxHold | lldpMessageTxHoldMultiplier | Multiplier value |
| | msgTxInterval | lldpMessageTxInterval | Transmit Interval value |
| | rxInfoTTL | lldpRxInfoTTL | Time to Live for received TLVs |
| | txInfoTTL | lldpTxInfoTTL | Time to Live for transmitted TLVs |
| Basic TLV Selection | mibBasicTLVsTxEnable | lldpPortConfigTLVsTxEnable | Indicates which management TLVs are enabled for system ports |
| | mibMgmtAddrInstanceTxEnable | lldpManAddrPortsTxEnable | The management addresses defined for the system and the ports through which they are enabled for transmission |
| LLDP Statistics | statsAgeoutsTotal | lldpStatsRxPortAgeoutsTotal | Total number of times that a neighbors information is deleted on the local system due to an rxInfoTTL timer expiration |
| | statsFramesDiscardedTotal | lldpStatsRxPortFramesDiscardedTotal | Total number of LLDP frames received then discarded |
| | statsFramesInErrorsTotal | lldpStatsRxPortFramesErrors | Total number of LLDP frames received on a port with errors |
| | statsFramesInTotal | lldpStatsRxPortFramesTotal | Total number of LLDP frames received through the port |
| | statsFramesOutTotal | lldpStatsTxPortFramesTotal | Total number of LLDP frames transmitted through the port |
| | statsTLVsDiscardedTotal | lldpStatsRxPortTLVsDiscardedTotal | Total number of TLVs received then discarded |
| | statsTLVsUnrecognizedTotal | lldpStatsRxPortTLVsUnrecognizedTotal | Total number of all TLVs the local agent does not recognize |

Table 29-8. LLDP System MIB Objects

| TLV Type | TLV Name | TLV Variable | System | LLDP MIB Object |
|-----------------|-----------------|---------------------|---------------|-------------------------|
| 1 | Chassis ID | chassis ID subtype | Local | lldpLocChassisIdSubtype |
| | | | Remote | lldpRemChassisIdSubtype |
| | | chassid ID | Local | lldpLocChassisId |
| | | | Remote | lldpRemChassisId |

Table 29-8. LLDP System MIB Objects

| TLV Type | TLV Name | TLV Variable | System | LLDP MIB Object |
|----------|---------------------|-----------------------------|--------|-------------------------|
| 2 | Port ID | port subtype | Local | lldpLocPortIdSubtype |
| | | | Remote | lldpRemPortIdSubtype |
| | | port ID | Local | lldpLocPortId |
| | | | Remote | lldpRemPortId |
| 4 | Port Description | port description | Local | lldpLocPortDesc |
| | | | Remote | lldpRemPortDesc |
| 5 | System Name | system name | Local | lldpLocSysName |
| | | | Remote | lldpRemSysName |
| 6 | System Description | system description | Local | lldpLocSysDesc |
| | | | Remote | lldpRemSysDesc |
| 7 | System Capabilities | system capabilities | Local | lldpLocSysCapSupported |
| | | | Remote | lldpRemSysCapSupported |
| 8 | Management Address | enabled capabilities | Local | lldpLocSysCapEnabled |
| | | | Remote | lldpRemSysCapEnabled |
| | | management address length | Local | lldpLocManAddrLen |
| | | | Remote | lldpRemManAddrLen |
| | | management address subtype | Local | lldpLocManAddrSubtype |
| | | | Remote | lldpRemManAddrSubtype |
| | | management address | Local | lldpLocManAddr |
| | | | Remote | lldpRemManAddr |
| | | interface numbering subtype | Local | lldpLocManAddrIfSubtype |
| | | | Remote | lldpRemManAddrIfSubtype |
| | | interface number | Local | lldpLocManAddrIfId |
| | | | Remote | lldpRemManAddrIfId |
| | | OID | Local | lldpLocManAddrOID |
| | | | Remote | lldpRemManAddrOID |

Table 29-9. LLDP 802.1 Organizationally Specific TLV MIB Objects

| TLV Type | TLV Name | TLV Variable | System | LLDP MIB Object |
|----------|--------------|--------------|--------|------------------------|
| 127 | Port-VLAN ID | PVID | Local | lldpXdot1LocPortVlanId |
| | | | Remote | lldpXdot1RemPortVlanId |

Table 29-9. LLDP 802.1 Organizationally Specific TLV MIB Objects

| TLV Type | TLV Name | TLV Variable | System | LLDP MIB Object |
|----------|------------------------------|----------------------------------|--------|--------------------------------|
| 127 | Port and Protocol VLAN ID | port and protocol VLAN supported | Local | lldpXdot1LocProtoVlanSupported |
| | | | Remote | lldpXdot1RemProtoVlanSupported |
| | | port and protocol VLAN enabled | Local | lldpXdot1LocProtoVlanEnabled |
| | | | Remote | lldpXdot1RemProtoVlanEnabled |
| | | PPVID | Local | lldpXdot1LocProtoVlanId |
| | | | Remote | lldpXdot1RemProtoVlanId |
| 127 | VLAN Name | VID | Local | lldpXdot1LocVlanId |
| | | | Remote | lldpXdot1RemVlanId |
| | | VLAN name length | Local | lldpXdot1LocVlanName |
| | | | Remote | lldpXdot1RemVlanName |
| | | VLAN name | Local | lldpXdot1LocVlanName |
| | | | Remote | lldpXdot1RemVlanName |

Table 29-10. LLDP-MED System MIB Objects

| TLV Sub-Type | TLV Name | TLV Variable | System | LLDP-MED MIB Object |
|--------------|--------------------------|-----------------------|--------|--|
| 1 | LLDP-MED Capabilities | LLDP-MED Capabilities | Local | lldpXMedPortCapSupported lldpXMedPortConfigTLVsTx Enable |
| | | | Remote | lldpXMedRemCapSupported, lldpXMedRemConfigTLVsTx Enable |
| | | LLDP-MED Class Type | Local | lldpXMedLocDeviceClass |
| | | | Remote | lldpXMedRemDeviceClass |

Table 29-10. LLDP-MED System MIB Objects

| TLV Sub-Type | TLV Name | TLV Variable | System | LLDP-MED MIB Object |
|--------------|---------------------|----------------------|--------|--------------------------------|
| 2 | Network Policy | Application Type | Local | lldpXMedLocMediaPolicyAppType |
| | | | Remote | lldpXMedRemMediaPolicyAppType |
| | | Unknown Policy Flag | Local | lldpXMedLocMediaPolicyUnknown |
| | | | Remote | lldpXMedLocMediaPolicyUnknown |
| | | Tagged Flag | Local | lldpXMedLocMediaPolicyTagged |
| | | | Remote | lldpXMedLocMediaPolicyTagged |
| | | VLAN ID | Local | lldpXMedLocMediaPolicyVlanID |
| | | | Remote | lldpXMedRemMediaPolicyVlanID |
| | | L2 Priority | Local | lldpXMedLocMediaPolicyPriority |
| | | | Remote | lldpXMedRemMediaPolicyPriority |
| | | DSCP Value | Local | lldpXMedLocMediaPolicyDscp |
| | | | Remote | lldpXMedRemMediaPolicyDscp |
| 3 | Location Identifier | Location Data Format | Local | lldpXMedLocLocationSubtype |
| | | | Remote | lldpXMedRemLocationSubtype |
| | | Location ID Data | Local | lldpXMedLocLocationInfo |
| | | | Remote | lldpXMedRemLocationInfo |

Table 29-10. LLDP-MED System MIB Objects

| TLV Sub-Type | TLV Name | TLV Variable | System | LLDP-MED MIB Object |
|--------------|------------------------|-------------------|--------|---|
| 4 | Extended Power via MDI | Power Device Type | Local | lldpXMedLocXPoEDeviceType |
| | | | Remote | lldpXMedRemXPoEDeviceType |
| | | Power Source | Local | lldpXMedLocXPoEPSEPowerSource, lldpXMedLocXPoEPDPowerSource |
| | | | Remote | lldpXMedRemXPoEPSEPowerSource, lldpXMedRemXPoEPDPowerSource |
| | | Power Priority | Local | lldpXMedLocXPoEPDPowerPriority, lldpXMedLocXPoEPSEPortPDPriority |
| | | | Remote | lldpXMedRemXPoEPSEPowerPriority, lldpXMedRemXPoEPDPowerPriority |
| | | Power Value | Local | lldpXMedLocXPoEPSEPortPowerAv, lldpXMedLocXPoEPDPowerReq |
| | | | Remote | lldpXMedRemXPoEPSEPowerAv, lldpXMedRemXPoEPDPowerReq |

Multicast Source Discovery Protocol (MSDP)

Multicast Source Discovery Protocol (MSDP) is supported on platforms:  

Protocol Overview

Multicast Source Discovery Protocol (MSDP) is a Layer 3 protocol that connects IPv4 PIM-SM domains. A domain in the context of MSDP is contiguous set of routers operating PIM within a common boundary defined by an exterior gateway protocol, such as BGP.

Each RP peers with every other RP via TCP. Through this connection, peers advertise the sources in their domain.

1. When an RP in a PIM-SM domain receives a PIM register message from a source it sends a Source-Active (SA) message (Figure 30-1) to MSDP peers.
2. Each MSDP peer receives and forwards the message to its peers away from the originating RP.
3. When an MSDP peer receives an SA message, it determines if there are any group members within the domain interested in any of the advertised sources. If there are, the receiving RP sends a join message to the originating RP, creating an SPT to the source.

Figure 30-1. Multicast Source Discovery Protocol

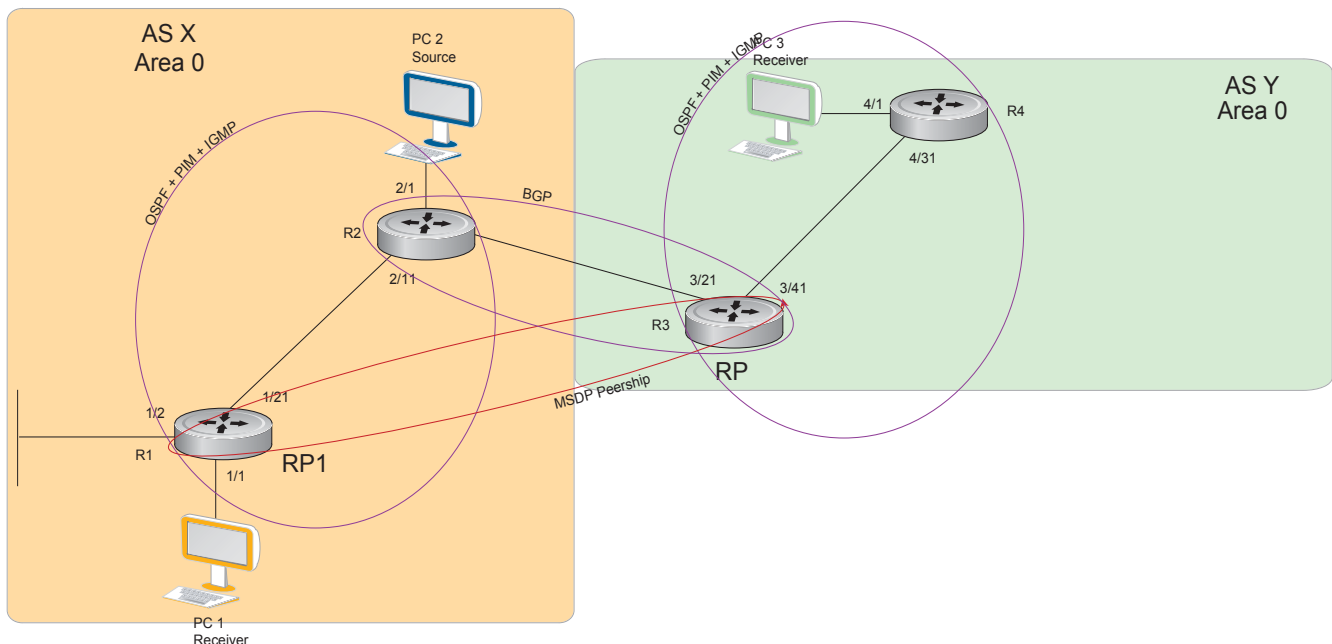

RPs advertise each (S,G) in its domain in Type, Length, Value (TLV) format. The total number of TLVs contained in the SA is indicated in the “Entry Count” field. SA messages are transmitted every 60 seconds, and immediately when a new source is detected.

Figure 30-2. MSDP SA Message Format

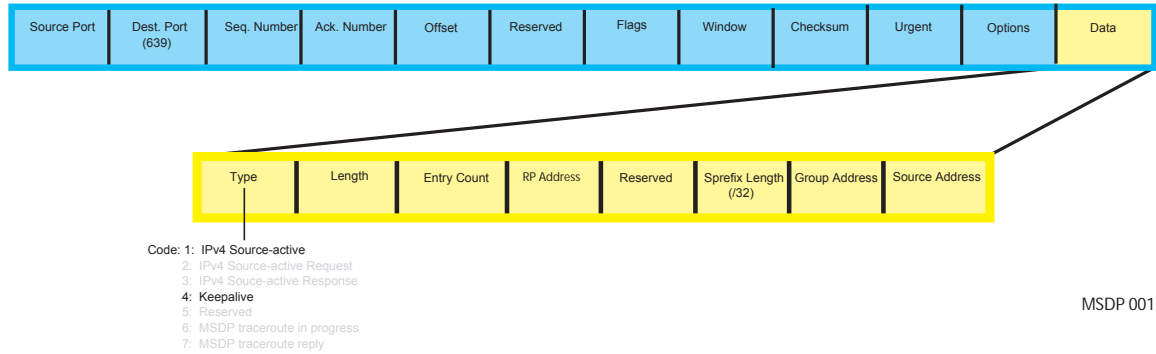

Anycast RP

Using Multicast Source Discovery Protocol (MSDP), Anycast RP provides load sharing and redundancy in Protocol Independent Multicast sparse mode (PIM-SM) networks. Anycast RP allows two or more rendezvous points (RPs) to share the load for source registration and the ability to act as hot backup routers for each other.

Anycast RP allows two or more RPs to be configured with the same IP address on loopback interfaces. The Anycast RP loopback address are configured with a 32-bit mask, making it a host address. All downstream routers are configured to know that the Anycast RP loopback address is the IP address of their local RP. IP routing automatically selects the closest RP for each source and receiver. Assuming that the sources are evenly spaced around the network, an equal number of sources register with each RP. Consequently, all the RPs in the network share the process of registering the sources equally. Since a source may register with one RP and receivers may join to a different RP, a method is needed for the RPs to exchange information about active sources. This information exchange is done with MSDP.

With Anycast RP, all the RPs are configured to be MSDP peers of each other. When a source registers with one RP, an SA message is sent to the other RPs informing them that there is an active source for a particular multicast group. The result is that each RP is aware of the active sources in the area of the other RPs. If any of the RPs fail, IP routing converges and one of the RPs becomes the active RP in more than one area. New sources register with the backup RP. Receivers join toward the new RP and connectivity is maintained.

Implementation Information

- The FTOS implementation of MSDP is in accordance with RFC 3618 and Anycast RP is in accordance with RFC 3446.

Configuring Multicast Source Discovery Protocol

Configuring MSDP is a three-step process:

1. Enable an exterior gateway protocol (EGP) with at least two routing domains.

Figure 30-5 and MSDP Sample Configurations on page 654 show the OSPF-BGP configuration used in this chapter for MSDP. Otherwise, see Chapter 33, Open Shortest Path First (OSPFv2) and Chapter 9, Border Gateway Protocol IPv4 (BGPv4).

2. Configure PIM-SM within each EGP routing domain.

Figure 30-5 and MSDP Sample Configurations show the PIM-SM configuration in this chapter for MSDP. Otherwise, see Chapter 34, “PIM Sparse-Mode (PIM-SM),” on page 717.

3. Enable MSDP. See page 638.

4. Peer the RPs in each routing domain with each other. See [Enable MSDP](#).

Related Configuration Tasks

- [Enable MSDP](#)
- [Manage the Source-active Cache](#)
- [Accept Source-active Messages that fail the RFP Check](#)
- [Limit the Source-active Messages from a Peer](#)
- [Prevent MSDP from Caching a Local Source](#)
- [Prevent MSDP from Caching a Remote Source](#)
- [Prevent MSDP from Advertising a Local Source](#)
- [Terminate a Peership](#)
- [Clear Peer Statistics](#)
- [Clear Peer Statistics](#)
- [Debug MSDP](#)
- [MSDP with Anycast RP](#)
- [MSDP Sample Configurations](#)

Figure 30-3. Configuring Interfaces for MSDP

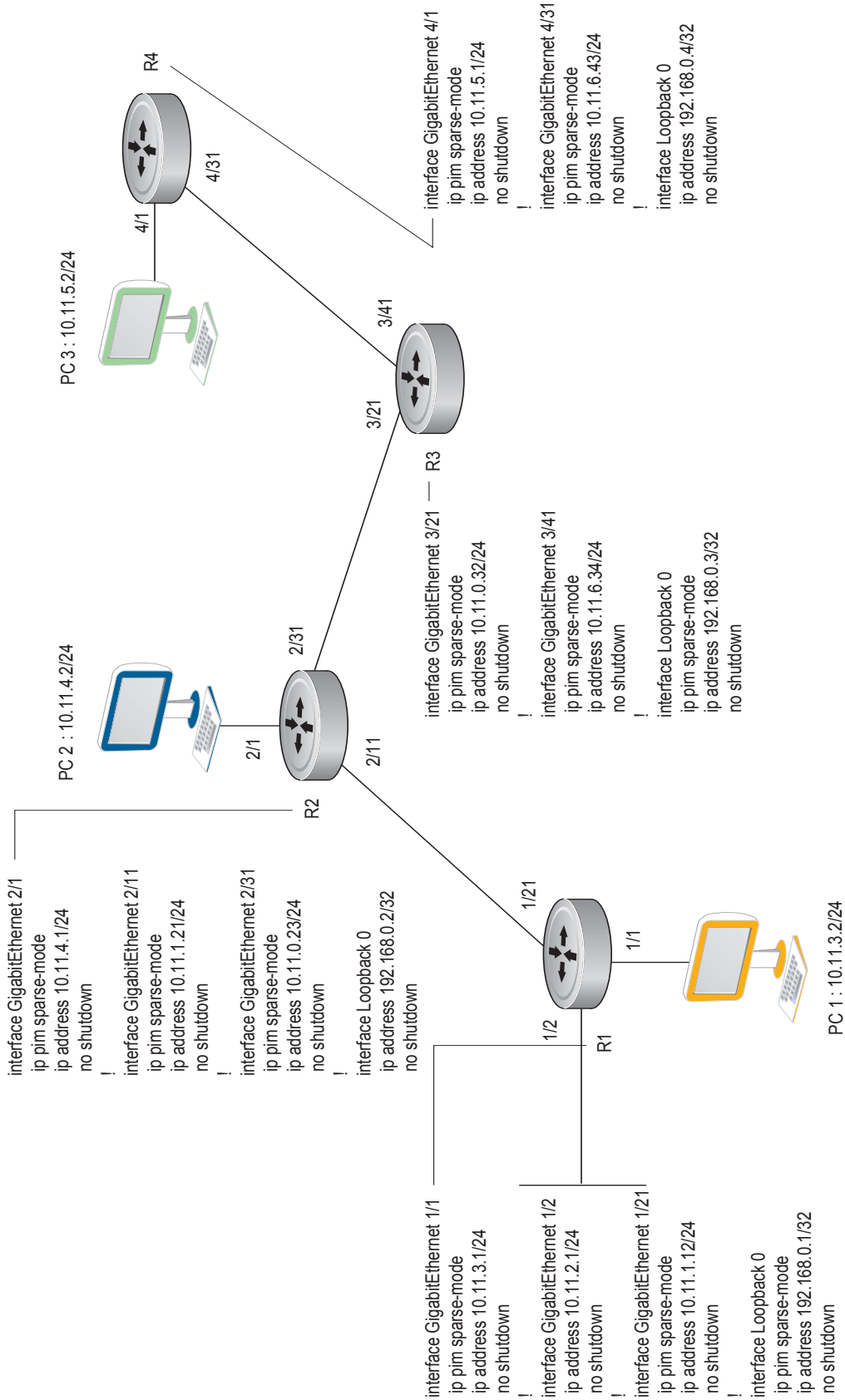

Figure 30-4. Configuring OSPF and BGP for MSDP

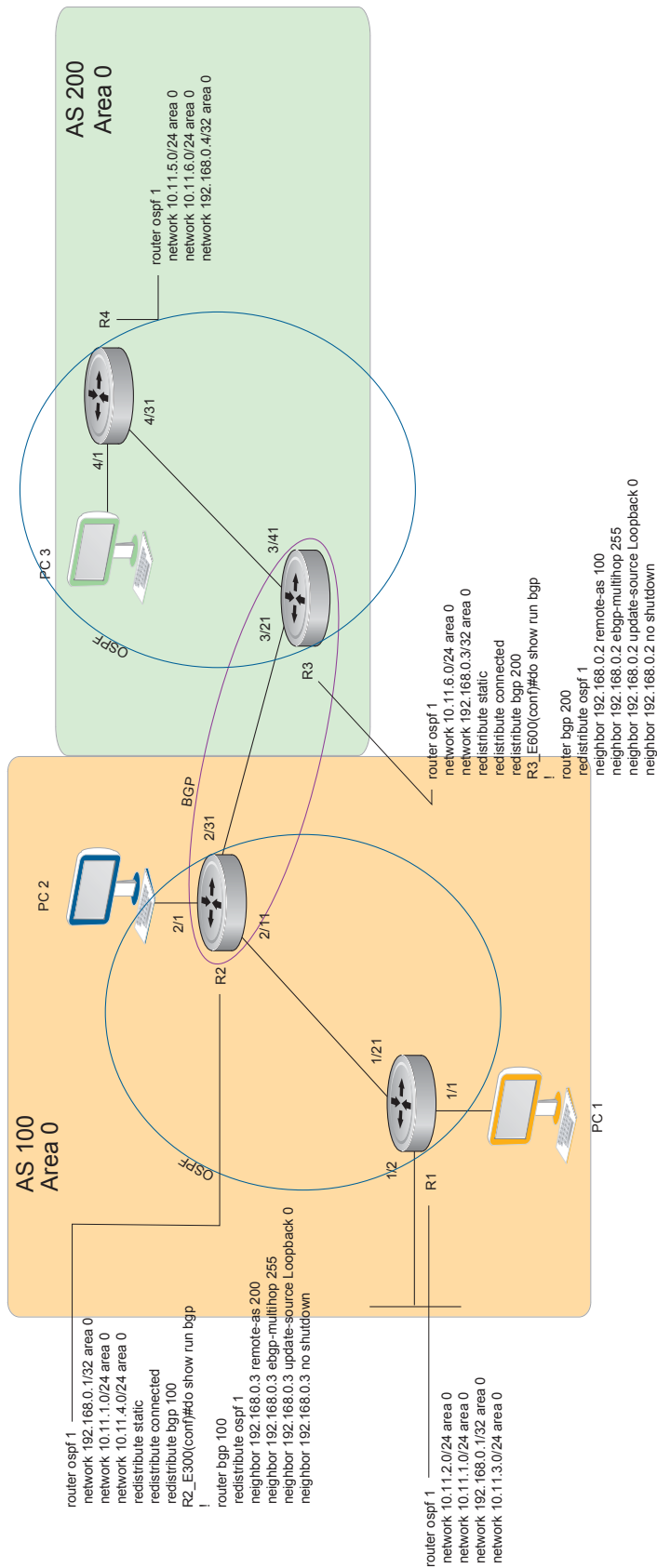

Figure 30-5. Configuring PIM in Multiple Routing Domains

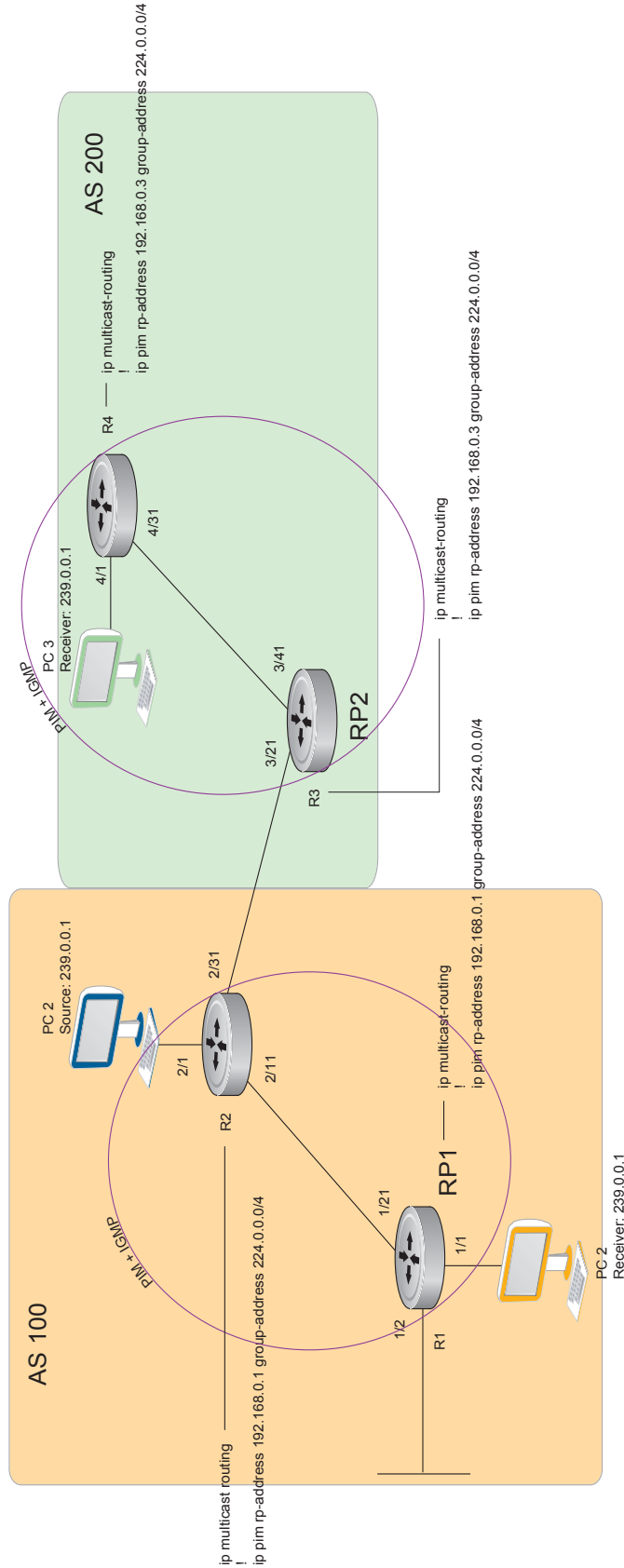
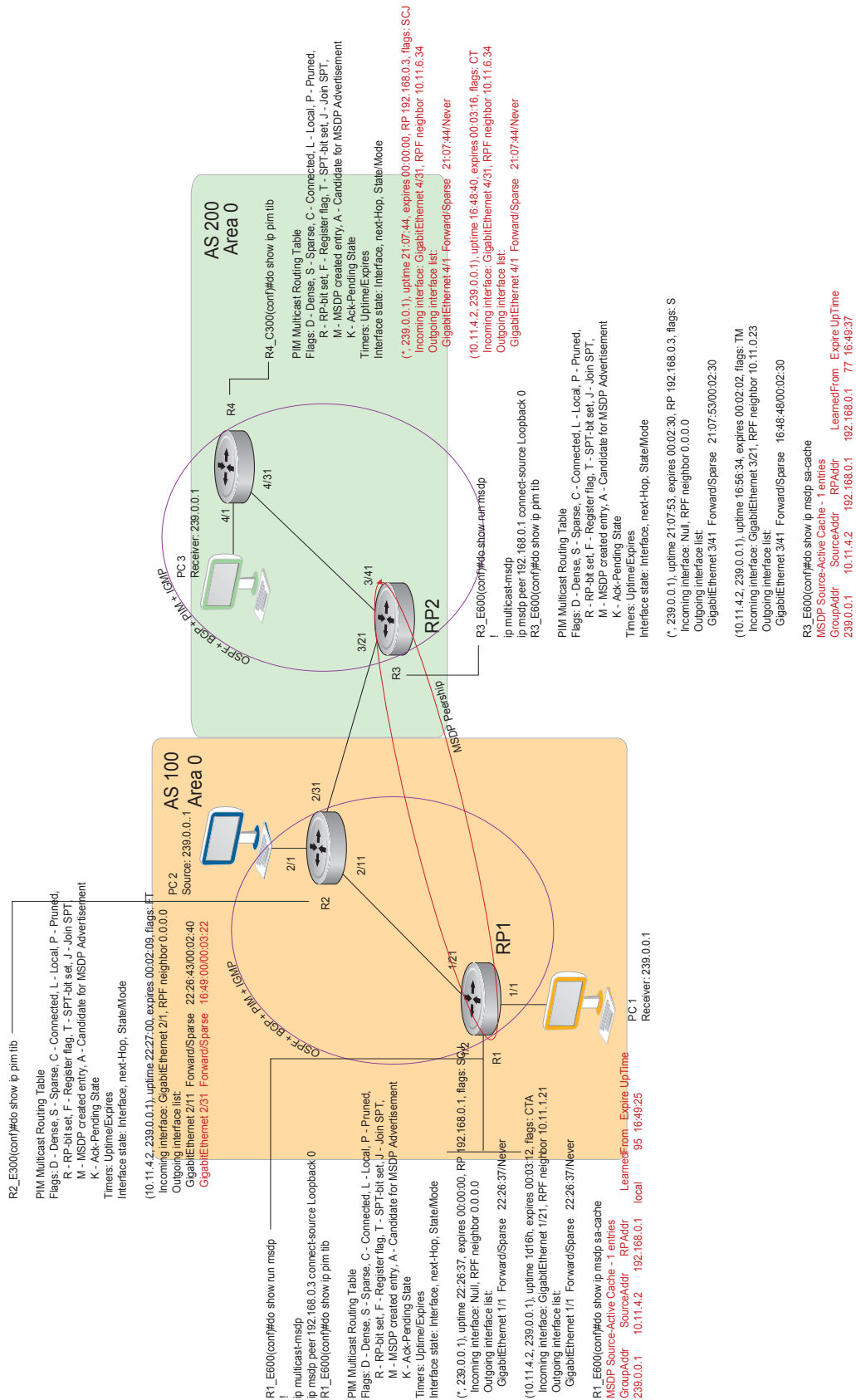

Figure 30-6. Configuring MSDP



Enable MSDP

Enable MSDP by peering RPs in different administrative domains.

| Step | Task | Command Syntax | Command Mode |
|------|--|-----------------------------|---------------|
| 1 | Enable MSDP. | ip multicast-msdp | CONFIGURATION |
| 2 | PeerPIM systems in different administrative domains. | ip msdp peer connect-source | CONFIGURATION |

Figure 30-7. Configuring an MSDP Peer

```
R3_E600(conf)#ip multicast-msdp
R3_E600(conf)#ip msdp peer 192.168.0.1 connect-source Loopback 0
R3_E600(conf)#do show ip msdp summary
```

| Peer Addr | Local Addr | State | Source | SA | Up/Down |
|-------------|------------|-------|--------|----|---------|
| Description | | | | | |

| Task | Command Syntax | Command Mode |
|----------------------------------|-------------------|----------------|
| View details about about a peer. | show ip msdp peer | EXEC Privilege |

Figure 30-8. Displaying Details about a Peer

```
R3_E600#show ip msdp peer

Peer Addr: 192.168.0.1
  Local Addr: 192.168.0.3(639)  Connect Source: Lo 0
  State: Established  Up/Down Time: 00:15:20
  Timers: KeepAlive 30 sec, Hold time 75 sec
  SourceActive packet count (in/out): 8/0
  SAs learned from this peer: 1
  SA Filtering:
  Input (S,G) filter: none
  Output (S,G) filter: none
```

Multicast sources in remote domains are stored on the RP in the Source-active cache (SA cache). The system does not create entries in the multicast routing table until there is a local receiver for the corresponding multicast group.

Manage the Source-active Cache

Each SA-originating RP caches the sources inside its domain (domain-local), and the sources which it has learned from its peers (domain-remote). By caching sources:

- domain-local receivers experience a lower join latency,

- RPs can transmit SA messages periodically to prevent SA storms, and
- only sources that are in the cache are advertised in the SA to prevent transmitting multiple copies of the same source information.

View the Source-active Cache

| Task | Command Syntax | Command Mode |
|--------------------|-----------------------|----------------|
| View the SA cache. | show ip msdp sa-cache | EXEC Privilege |

Figure 30-9. Displaying the MSDP Source-active Cache

```
R3_E600#show ip msdp sa-cache
MSDP Source-Active Cache - 1 entries
GroupAddr      SourceAddr      RPAAddr      LearnedFrom      Expire UpTime
239.0.0.1      10.11.4.2      192.168.0.1  192.168.0.1      76 00:10:44
```

Limit the Source-active Cache

Set the upper limit of the number of active sources that FTOS caches. The default active source limit is 500K messages. When the total number of active sources reaches the specified limit, subsequent active sources are dropped even if they pass the RPF and policy check.

| Task | Command Syntax | Command Mode |
|---|-----------------------|----------------|
| Limit the number of sources that can be stored in the SA cache. | show ip msdp sa-limit | EXEC Privilege |

If the total number of active sources is already larger than the limit when limiting is applied, the sources that are already in FTOS are not discarded. To enforce the limit in such a situation, use the command `clear ip msdp sa-cache` to clear all existing entries.

Clear the Source-active Cache

| Task | Command Syntax | Command Mode |
|---|--|---------------|
| Clear the SA cache of all, local, or rejected entries, or entries for a specific group. | clear ip msdp sa-cache [group-address local rejected-sa] | CONFIGURATION |

Enable the Rejected Source-active Cache

Active sources can be rejected because

- the RPF check failed,
- the SA limit is reached,

- the peer RP is unreachable,
- or because of an SA message format error.

| Task | Command Syntax | Command Mode |
|-------------------------|---------------------------|---------------|
| Cache rejected sources. | ip msdp cache-rejected-sa | CONFIGURATION |

Accept Source-active Messages that fail the RFP Check

A default peer is a peer from which active sources are accepted even though they fail the RFP check.

- In Scenario 1 of [Figure 30-10](#), all MSDP peers are up.
- In Scenario 2, the peership between RP1 and RP2 is down, but the link (and routing protocols) between them is still up. In this case, RP1 learns all active sources from RP3, but the sources from RP2 and RP4 are rejected because the reverse path to these routers is through Interface A.
- In Scenario 3, RP3 is configured as a default MSDP peer for RP1 and so the RPF check is disregarded for RP3.
- In Scenario 4, RP1 has a default peer plus an access list. The list permits RP4 so the RPF check is disregarded for active sources from it, but RP5 (and all others because of the implicit deny all) are subject to the RPF check and fail, so those active sources are rejected.

Figure 30-10. MSDP Default Peer

Scenario 1

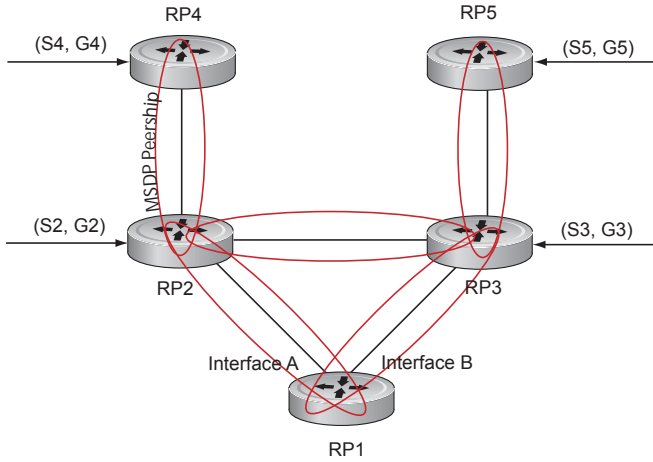

| Group | Source | RP | Peer |
|-------|--------|-----|------|
| G2 | S2 | RP2 | R2 |
| G3 | S3 | RP3 | R3 |
| G4 | S4 | RP4 | R4 |
| G5 | S5 | RP5 | R5 |

Scenario 3

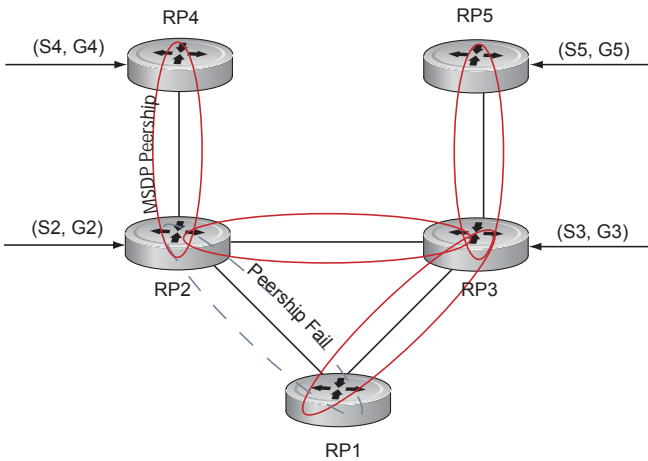

| Group | Source | RP | Peer |
|-------|--------|-----|------|
| G2 | S2 | RP2 | R3 |
| G3 | S3 | RP3 | R3 |
| G4 | S4 | RP4 | R3 |
| G5 | S5 | RP5 | R3 |

Scenario 2

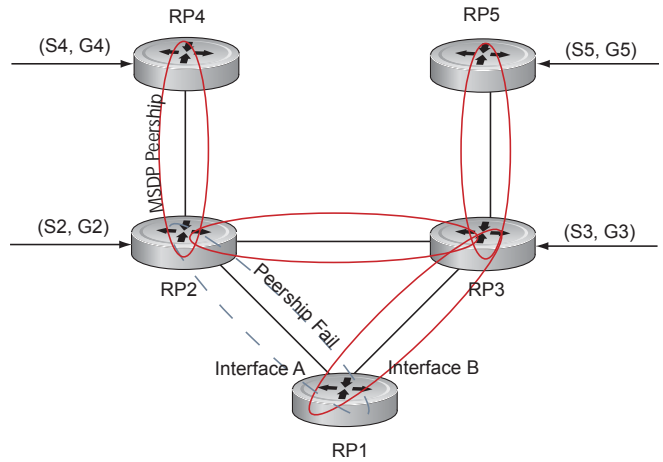

| Group | Source | RP | Peer |
|-------|--------|-----|-------------|
| G2 | S2 | RP2 | R3 RPF-Fail |
| G3 | S3 | RP3 | R3 |
| G4 | S4 | RP4 | R3 RPF-Fail |
| G5 | S5 | RP5 | R3 |

Scenario 4

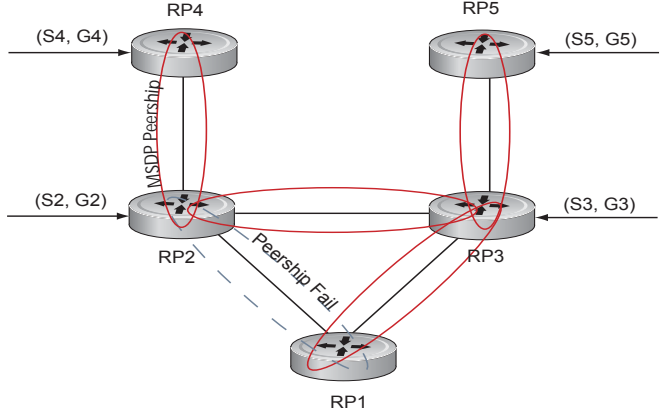

| Group | Source | RP | Peer |
|-------|--------|-----|-------------|
| G2 | S2 | RP2 | R3 RPF-Fail |
| G3 | S3 | RP3 | R3 |
| G4 | S4 | RP4 | R3 |
| G5 | S5 | RP5 | R3 |

| Task | Command Syntax | Command Mode |
|---|--|---------------|
| Specify the forwarding-peer and originating-RP from which all active sources are accepted without regard for the RPF check. If you do not specify an access list, the peer accepts all sources advertised by that peer. All sources from RPs denied by the ACL are subjected to the normal RPF check. | <code>ip msdp default-peer <i>ip-address</i> list</code> | CONFIGURATION |

Figure 30-11. Accepting Source-active Messages with

```

FTOS(conf)#ip msdp peer 10.0.50.2 connect-source Vlan 50
FTOS(conf)#ip msdp default-peer 10.0.50.2 list fifty

FTOS(conf)#ip access-list standard fifty
FTOS(conf)#seq 5 permit host 200.0.0.50

FTOS#ip msdp sa-cache
MSDP Source-Active Cache - 3 entries
GroupAddr      SourceAddr      RPAAddr          LearnedFrom      Expire UpTime
229.0.50.2     24.0.50.2      200.0.0.50      10.0.50.2       73 00:13:49
229.0.50.3     24.0.50.3      200.0.0.50      10.0.50.2       73 00:13:49
229.0.50.4     24.0.50.4      200.0.0.50      10.0.50.2       73 00:13:49

FTOS#ip msdp sa-cache rejected-sa
MSDP Rejected SA Cache
3 rejected SAs received, cache-size 32766
UpTime      GroupAddr      SourceAddr      RPAAddr          LearnedFrom      Reason
00:33:18   229.0.50.64   24.0.50.64     200.0.1.50      10.0.50.2       Rpf-Fail
00:33:18   229.0.50.65   24.0.50.65     200.0.1.50      10.0.50.2       Rpf-Fail
00:33:18   229.0.50.66   24.0.50.66     200.0.1.50      10.0.50.2       Rpf-Fail

```

Limit the Source-active Messages from a Peer

| Task | Command Syntax | Command Mode |
|---|--|---------------|
| OPTIONAL: Store sources that are received after the limit is reached in the rejected SA cache. | <code>ip msdp cache-rejected-sa</code> | CONFIGURATION |
| Set the upper limit for the number of sources allowed from an MSDP peer. The default limit is 100K. | <code>ip msdp peer <i>peer-address</i> sa-limit</code> | CONFIGURATION |

If the total number of sources received from the peer is already larger than the limit when this configuration is applied, those sources are not discarded. To enforce the limit in such a situation, first clear the SA cache.

Prevent MSDP from Caching a Local Source

You can prevent MSDP from caching an active source based on source and/or group. Since the source is not cached, it is not advertised to remote RPs.

| Task | Command Syntax | Command Mode |
|---|---------------------------|---------------|
| OPTIONAL: Cache sources that are denied by the redistribute list in the rejected SA cache. | ip msdp cache-rejected-sa | CONFIGURATION |
| Prevent the system from caching local SA entries based on source and group using an extended ACL. | ip msdp redistribute list | CONFIGURATION |

When you apply this filter, the SA cache is not affected immediately. When sources which are denied by the ACL time out, they are not refreshed. Until they time out, they continue to reside in the cache. To apply the redistribute filter to entries already present in the SA cache, first clear the SA cache. You may optionally store denied sources in the rejected SA cache.

Figure 30-12. Preventing MSDP from Caching a Local Source

```
R1_E600(conf)#do show run msdp
!
ip multicast-msdp
ip msdp peer 192.168.0.3 connect-source Loopback 0
ip msdp redistribute list mylocalfilter
ip msdp cache-rejected-sa 1000
R1_E600(conf)#do show run acl
!
ip access-list extended mylocalfilter
 seq 5 deny ip host 239.0.0.1 host 10.11.4.2
 seq 10 deny ip any any
R1_E600(conf)#do show ip msdp sa-cache
R1_E600(conf)#do show ip msdp sa-cache rejected-sa
MSDP Rejected SA Cache
 1 rejected SAs received, cache-size 1000
UpTime      GroupAddr    SourceAddr    RPAddr        LearnedFrom    Reason
00:02:20    239.0.0.1    10.11.4.2    192.168.0.1   local          Redistribute
```

Prevent MSDP from Caching a Remote Source

| Task | Command Syntax | Command Mode |
|--|--|---------------|
| OPTIONAL: Cache sources that are denied by the SA filter in the rejected SA cache. | <code>ip msdp cache-rejected-sa</code> | CONFIGURATION |
| Prevent the system from caching remote sources learned from a specific peer based on source and group. | <code>ip msdp sa-filter list out <i>peer list ext-acl</i></code> | CONFIGURATION |

In [Figure 30-14](#), R1 is advertising source 10.11.4.2. It is already in the SA cache of R3 when an ingress SA filter is applied to R3. The entry remains in the SA cache until it expires; it is not stored in the rejected SA cache.

Figure 30-13. Preventing MSDP from Advertising a Local Source

```
[Router 3]
R3_E600(conf)#do show run msdp
!
ip multicast-msdp
ip msdp peer 192.168.0.1 connect-source Loopback 0
ip msdp sa-filter in 192.168.0.1 list myremotefilter
R3_E600(conf)#do show run acl
!
ip access-list extended myremotefilter
 seq 5 deny ip host 239.0.0.1 host 10.11.4.2
R3_E600(conf)#do show ip msdp sa-cache
MSDP Source-Active Cache - 1 entries
GroupAddr      SourceAddr      RPAAddr      LearnedFrom      Expire UpTime
239.0.0.1      10.11.4.2      192.168.0.1  192.168.0.1      1      00:03:59
R3_E600(conf)#do show ip msdp sa-cache
R3_E600(conf)#
R3_E600(conf)#do show ip msdp peer

Peer Addr: 192.168.0.1
Local Addr: 0.0.0.0(639) Connect Source: Lo 0
State: Listening Up/Down Time: 00:01:19
Timers: KeepAlive 30 sec, Hold time 75 sec
SourceActive packet count (in/out): 0/0
SAs learned from this peer: 0
SA Filtering:
Input (S,G) filter: myremotefilter
Output (S,G) filter: none
```

Prevent MSDP from Advertising a Local Source

| Task | Command Syntax | Command Mode |
|--|--|---------------|
| Prevent an RP from advertising a source in the SA cache. | <code>ip msdp sa-filter list in peer list ext-acl</code> | CONFIGURATION |

In [Figure 30-14](#), R1 stops advertising source 10.11.4.2. Since it is already in the SA cache of R3, the entry remains there until it expires.

Figure 30-14. Preventing MSDP from Advertising a Local Source

```
[Router 1]
R1_E600(conf)#do show run msdp
!
ip multicast-msdp
ip msdp peer 192.168.0.3 connect-source Loopback 0
ip msdp sa-filter out 192.168.0.3 list mylocalfilter
R1_E600(conf)#do show run acl
!
ip access-list extended mylocalfilter
 seq 5 deny ip host 239.0.0.1 host 10.11.4.2
 seq 10 deny ip any any
R1_E600(conf)#do show ip msdp sa-cache
MSDP Source-Active Cache - 1 entries
GroupAddr      SourceAddr      RPAAddr          LearnedFrom      Expire UpTime
239.0.0.1      10.11.4.2      192.168.0.1     local            70 00:27:20
R3_E600(conf)#do show ip msdp sa-cache
MSDP Source-Active Cache - 1 entries
GroupAddr      SourceAddr      RPAAddr          LearnedFrom      Expire UpTime
239.0.0.1      10.11.4.2      192.168.0.1     192.168.0.1     1 00:10:29

[Router 3]
R3_E600(conf)#do show ip msdp sa-cache
R3_E600(conf)#
```

Display the configured SA filters for a peer using the command `show ip msdp peer` from EXEC Privilege mode (see [Figure 30-14](#)).

Log Changes in Peership States

| Task | Command Syntax | Command Mode |
|-----------------------------|-------------------------------|---------------|
| Log peership state changes. | ip msdp log-adjacency-changes | CONFIGURATION |

Terminate a Peership

MSDP uses TCP as its transport protocol. In a peering relationship, the peer with the lower IP address initiates the TCP session, while the peer with the higher IP address listens on port 639.

| Task | Command Syntax | Command Mode |
|---|------------------|---------------|
| Terminate the TCP connection with a peer. | ip msdp shutdown | CONFIGURATION |

Once the relationship is terminated, the peering state of the terminator is SHUTDOWN, while the peering state of the peer is INACTIVE.

Figure 30-15. Terminating a Peership

```
[Router 3]
R3_E600(conf)#ip msdp shutdown 192.168.0.1
R3_E600(conf)#do show ip msdp peer

Peer Addr: 192.168.0.1
  Local Addr: 0.0.0.0(0)  Connect Source: Lo 0
  State: Shutdown      Up/Down Time: 00:00:18
  Timers: KeepAlive 30 sec, Hold time 75 sec
  SourceActive packet count (in/out): 0/0
  SAs learned from this peer: 0
  SA Filtering:
  Input (S,G) filter: myremotefilter
  Output (S,G) filter: none
[Router 1]
R1_E600(conf)#do show ip msdp peer

Peer Addr: 192.168.0.3
  Local Addr: 0.0.0.0(0)  Connect Source: Lo 0
  State: Inactive      Up/Down Time: 00:00:03
  Timers: KeepAlive 30 sec, Hold time 75 sec
  SourceActive packet count (in/out): 0/0
  SAs learned from this peer: 0
  SA Filtering:
```

Clear Peer Statistics

| Task | Command Syntax | Command Mode |
|---|---------------------------------|---------------|
| Reset the TCP connection to the peer and clear all peer statistics. | clear ip msdp peer peer-address | CONFIGURATION |

Figure 30-16. Clearing Peer Statistics

```
R3_E600(conf)#do show ip msdp peer

Peer Addr: 192.168.0.1
  Local Addr: 192.168.0.3(639)  Connect Source: Lo 0
  State: Established  Up/Down Time: 00:04:26
  Timers: KeepAlive 30 sec, Hold time 75 sec
  SourceActive packet count (in/out): 5/0
  SAs learned from this peer: 0
  SA Filtering:
  Input (S,G) filter: myremotefilter
  Output (S,G) filter: none
R3_E600(conf)#do clear ip msdp peer 192.168.0.1
R3_E600(conf)#do show ip msdp peer

Peer Addr: 192.168.0.1
  Local Addr: 0.0.0.0(0)  Connect Source: Lo 0
  State: Inactive  Up/Down Time: 00:00:04
  Timers: KeepAlive 30 sec, Hold time 75 sec
  SourceActive packet count (in/out): 0/0
  SAs learned from this peer: 0
  SA Filtering:
  Input (S,G) filter: myremotefilter
  Output (S,G) filter: none
```

Debug MSDP

| Task | Command Syntax | Command Mode |
|--|----------------|---------------|
| Display the information exchanged between peers. | debug ip msdp | CONFIGURATION |

Figure 30-17. Debugging MSDP

```
R1_E600(conf)#do debug ip msdp
All MSDP debugging has been turned on
R1_E600(conf)#03:16:08 : MSDP-0: Peer 192.168.0.3, sent Keepalive msg
03:16:09 : MSDP-0: Peer 192.168.0.3, rcvd Keepalive msg
03:16:27 : MSDP-0: Peer 192.168.0.3, sent Source Active msg
03:16:38 : MSDP-0: Peer 192.168.0.3, sent Keepalive msg
03:16:39 : MSDP-0: Peer 192.168.0.3, rcvd Keepalive msg
03:17:09 : MSDP-0: Peer 192.168.0.3, sent Keepalive msg
03:17:10 : MSDP-0: Peer 192.168.0.3, rcvd Keepalive msg
03:17:27 : MSDP-0: Peer 192.168.0.3, sent Source Active msg
Input (S,G) filter: none
Output (S,G) filter: none
```

MSDP with Anycast RP

Anycast RP use MSDP with PIM-SM to allow more than one active group to RP mapping.

PIM-SM allows only active group to RP mapping, which has several implications:

- **traffic concentration:** PIM-SM allows only one active group to RP mapping which means that all traffic for the group must, at least initially, travel over the same part of the network. You can load balance source registration between multiple RPs by strategically mapping groups to RPs, but this technique is less effective as traffic increases because preemptive load balancing requires prior knowledge of traffic distributions.
- **lack of scalable register decapsulation:** With only a single RP per group, all joins are sent to that RP regardless of the topological distance between the RP, sources, and receivers, and data is transmitted to the RP until the SPT switch threshold is reached.
- **slow convergence when an active RP fails:** When multiple RPs are configured, there can be considerable convergence delay involved in switching to the backup RP.

Anycast RP relieves these limitations by allowing multiple RPs per group, which can be distributed in a topologically significant manner according to the locations of the sources and receivers.

1. All the RPs serving a given group are configured with an identical anycast address.
2. Sources then register with the topologically closest RP.
3. RPs use MSDP to peer with each other using a unique address.

Figure 30-18. MSDP with Anycast RP

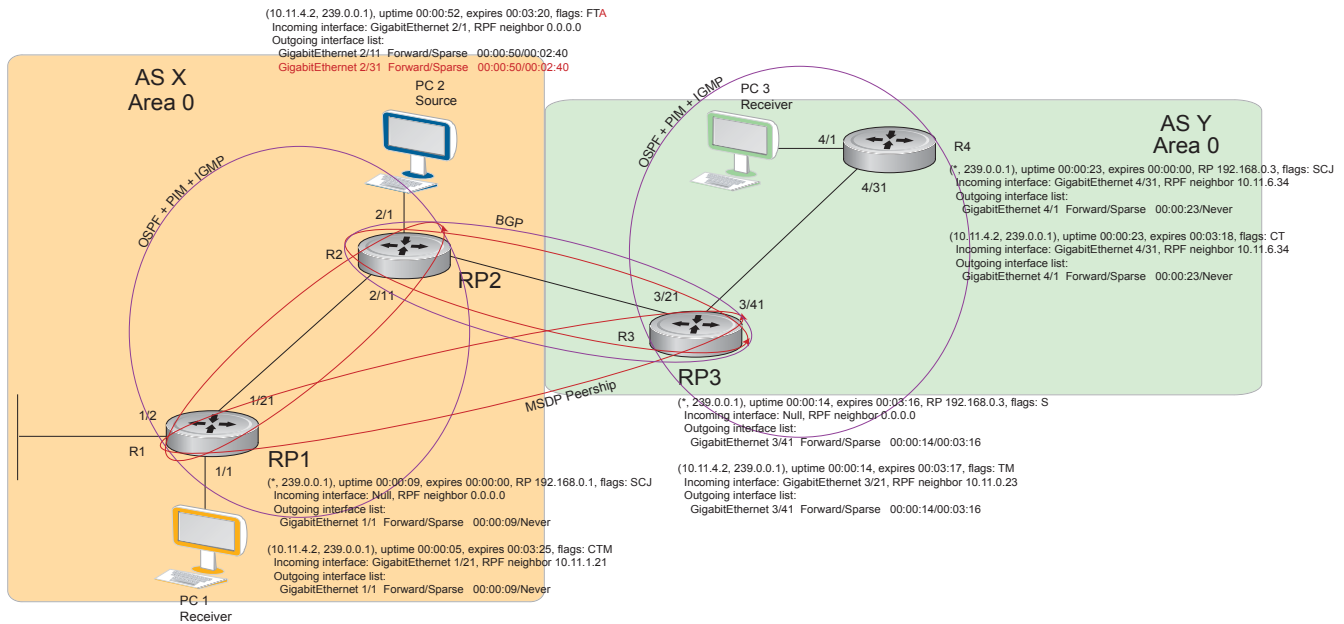

To configure Anycast RP:

| Step | Task | Command Syntax | Command Mode |
|------|--|--------------------|---------------|
| 1 | In each routing domain that will have multiple RPs serving a group, create a loopback interface on each RP serving the group with the same IP address. | interface loopback | CONFIGURATION |
| 2 | Make this address the RP for the group. | ip pim rp-address | CONFIGURATION |
| 3 | In each routing domain that will have multiple RPs serving a group, create another loopback interface on each RP serving the group with a unique IP address. | interface loopback | CONFIGURATION |
| 4 | Peer each RP with every other RP using MSDP, specifying the unique loopback address as the connect-source. | ip msdp peer | CONFIGURATION |
| 5 | Advertise the network of each of the unique loopback addresses throughout the network. | network | ROUTER OSPF |

Reducing Source-active Message Flooding

RPs flood source-active messages to all of their peers away from the RP. When multiple RPs exist within a domain, the RPs forward received active source information back to the originating RP, which violates the RFP rule. You can prevent this unnecessary flooding by creating a mesh-group. A mesh in this context is a topology in which each RP in a set of RPs has a peership with all other RPs in the set. When an RP is a member of the mesh group, it forwards active source information only to its peers outside of the group.

| Task | Command Syntax | Command Mode |
|----------------------|--------------------|---------------|
| Create a mesh group. | ip msdp mesh-group | CONFIGURATION |

Specify the RP Address Used in SA Messages

The default originator-id is the address of the RP that created the message. In the case of Anycast RP, there are multiple RPs all with the same address. You can use the (unique) address of another interface as the originator-id.

| Task | Command Syntax | Command Mode |
|--|-----------------------|---------------|
| Use the address of another interface as the originator-id instead of the RP address. | ip msdp originator-id | CONFIGURATION |

Figure 30-19. R1 Configuration for MSDP with Anycast RP

```
ip multicast-routing
!
interface GigabitEthernet 1/1
 ip pim sparse-mode
 ip address 10.11.3.1/24
 no shutdown
!
interface GigabitEthernet 1/2
 ip address 10.11.2.1/24
 no shutdown
!
interface GigabitEthernet 1/21
 ip pim sparse-mode
 ip address 10.11.1.12/24
 no shutdown
!
interface Loopback 0
 ip pim sparse-mode
 ip address 192.168.0.1/32
 no shutdown
!
interface Loopback 1
 ip address 192.168.0.11/32
 no shutdown
!
router ospf 1
 network 10.11.2.0/24 area 0
 network 10.11.1.0/24 area 0
 network 10.11.3.0/24 area 0
 network 192.168.0.11/32 area 0
!
ip multicast-msdp
ip msdp peer 192.168.0.3 connect-source Loopback 1
ip msdp peer 192.168.0.22 connect-source Loopback 1
ip msdp mesh-group AS100 192.168.0.22
ip msdp originator-id Loopback 1
!
ip pim rp-address 192.168.0.1 group-address 224.0.0.0/4
```

Figure 30-20. R2 Configuration for MSDP with Anycast RP

```
ip multicast-routing
!
interface GigabitEthernet 2/1
 ip pim sparse-mode
 ip address 10.11.4.1/24
 no shutdown
!
interface GigabitEthernet 2/11
 ip pim sparse-mode
 ip address 10.11.1.21/24
 no shutdown
!
interface GigabitEthernet 2/31
 ip pim sparse-mode
 ip address 10.11.0.23/24
 no shutdown
!
interface Loopback 0
 ip pim sparse-mode
 ip address 192.168.0.1/32
 no shutdown
!
interface Loopback 1
 ip address 192.168.0.22/32
 no shutdown
!
router ospf 1
 network 10.11.1.0/24 area 0
 network 10.11.4.0/24 area 0
 network 192.168.0.22/32 area 0
 redistribute static
 redistribute connected
 redistribute bgp 100
!
router bgp 100
 redistribute ospf 1
 neighbor 192.168.0.3 remote-as 200
 neighbor 192.168.0.3 ebgp-multihop 255
 neighbor 192.168.0.3 no shutdown
!
ip multicast-msdp
 ip msdp peer 192.168.0.3 connect-source Loopback 1
 ip msdp peer 192.168.0.11 connect-source Loopback 1
 ip msdp mesh-group AS100 192.168.0.11
 ip msdp originator-id Loopback 1
!
 ip route 192.168.0.3/32 10.11.0.32
!
 ip pim rp-address 192.168.0.1 group-address 224.0.0.0/4
```

Figure 30-21. R3 Configuration for MSDP with Anycast RP

```
ip multicast-routing
!
interface GigabitEthernet 3/21
 ip pim sparse-mode
 ip address 10.11.0.32/24
 no shutdown

interface GigabitEthernet 3/41
 ip pim sparse-mode
 ip address 10.11.6.34/24
 no shutdown
!
interface Loopback 0
 ip pim sparse-mode
 ip address 192.168.0.3/32
 no shutdown
!
router ospf 1
 network 10.11.6.0/24 area 0
 network 192.168.0.3/32 area 0
 redistribute static
 redistribute connected
 redistribute bgp 200
!
router bgp 200
 redistribute ospf 1
 neighbor 192.168.0.22 remote-as 100
 neighbor 192.168.0.22 ebgp-multihop 255
 neighbor 192.168.0.22 update-source Loopback 0
 neighbor 192.168.0.22 no shutdown
!
ip multicast-msdp
ip msdp peer 192.168.0.11 connect-source Loopback 0
ip msdp peer 192.168.0.22 connect-source Loopback 0
ip msdp sa-filter out 192.168.0.22
!
ip route 192.168.0.1/32 10.11.0.23
ip route 192.168.0.22/32 10.11.0.23
!
ip pim rp-address 192.168.0.3 group-address 224.0.0.0/4
```

MSDP Sample Configurations

The following figures show the running-configurations for the routers shown in figures [Figure 30-5](#), [Figure 30-4](#), [Figure 30-5](#), [Figure 30-6](#).

Figure 30-22. MSDP Sample Configuration: R1 Running-config

```
ip multicast-routing
!
interface GigabitEthernet 1/1
 ip pim sparse-mode
 ip address 10.11.3.1/24
 no shutdown
!
interface GigabitEthernet 1/2
 ip address 10.11.2.1/24
 no shutdown
!
interface GigabitEthernet 1/21
 ip pim sparse-mode
 ip address 10.11.1.12/24
 no shutdown
!
interface Loopback 0
 ip pim sparse-mode
 ip address 192.168.0.1/32
 no shutdown
!
router ospf 1
 network 10.11.2.0/24 area 0
 network 10.11.1.0/24 area 0
 network 192.168.0.1/32 area 0
 network 10.11.3.0/24 area 0
!
ip multicast-msdp
ip msdp peer 192.168.0.3 connect-source Loopback 0
!
ip pim rp-address 192.168.0.1 group-address 224.0.0.0/4
```

Figure 30-23. MSDP Sample Configuration: R2 Running-config

```
ip multicast-routing
!
interface GigabitEthernet 2/1
 ip pim sparse-mode
 ip address 10.11.4.1/24
 no shutdown
!
interface GigabitEthernet 2/11
 ip pim sparse-mode
 ip address 10.11.1.21/24
 no shutdown
!
interface GigabitEthernet 2/31
 ip pim sparse-mode
 ip address 10.11.0.23/24
 no shutdown
!
interface Loopback 0
 ip address 192.168.0.2/32
 no shutdown
!
router ospf 1
 network 10.11.1.0/24 area 0
 network 10.11.4.0/24 area 0
 network 192.168.0.2/32 area 0
 redistribute static
 redistribute connected
 redistribute bgp 100
!
router bgp 100
 redistribute ospf 1
 neighbor 192.168.0.3 remote-as 200
 neighbor 192.168.0.3 ebgp-multihop 255
 neighbor 192.168.0.3 update-source Loopback 0
 neighbor 192.168.0.3 no shutdown
!
ip route 192.168.0.3/32 10.11.0.32
!
ip pim rp-address 192.168.0.1 group-address 224.0.0.0/4
```

Figure 30-24. MSDP Sample Configuration: R3 Running-config

```
ip multicast-routing
!
interface GigabitEthernet 3/21
 ip pim sparse-mode
 ip address 10.11.0.32/24
 no shutdown
!
interface GigabitEthernet 3/41
 ip pim sparse-mode
 ip address 10.11.6.34/24
 no shutdown
!
interface ManagementEthernet 0/0
 ip address 10.11.80.3/24
 no shutdown
!
interface Loopback 0
 ip pim sparse-mode
 ip address 192.168.0.3/32
 no shutdown
!
router ospf 1
 network 10.11.6.0/24 area 0
 network 192.168.0.3/32 area 0
 redistribute static
 redistribute connected
 redistribute bgp 200
!
router bgp 200
 redistribute ospf 1
 neighbor 192.168.0.2 remote-as 100
 neighbor 192.168.0.2 ebgp-multihop 255
 neighbor 192.168.0.2 update-source Loopback 0
 neighbor 192.168.0.2 no shutdown
!
ip multicast-msdp
 ip msdp peer 192.168.0.1 connect-source Loopback 0
!
ip route 192.168.0.2/32 10.11.0.23
```

Figure 30-25. MSDP Sample Configuration: R4 Running-config

```
ip multicast-routing
!
interface GigabitEthernet 4/1
 ip pim sparse-mode
 ip address 10.11.5.1/24
 no shutdown
!
interface GigabitEthernet 4/22
 ip address 10.10.42.1/24
 no shutdown
!
interface GigabitEthernet 4/31
 ip pim sparse-mode
 ip address 10.11.6.43/24
 no shutdown
!
interface Loopback 0
 ip address 192.168.0.4/32
 no shutdown
!
router ospf 1
 network 10.11.5.0/24 area 0
 network 10.11.6.0/24 area 0
 network 192.168.0.4/32 area 0
!
ip pim rp-address 192.168.0.3 group-address 224.0.0.0/4
```

Multiple Spanning Tree Protocol (MSTP)

Multiple Spanning Tree Protocol (MSTP) is supported on platforms: e c s **S4810**

S4820T

Protocol Overview

Multiple Spanning Tree Protocol (MSTP)—specified in IEEE 802.1Q-2003—is an RSTP-based spanning tree variation that improves on PVST+. MSTP allows multiple spanning tree instances and allows you to map many VLANs to one spanning tree instance to reduce the total number of required instances.

In contrast, PVST+ allows a spanning tree instance for each VLAN. This 1:1 approach is not suitable if you have many VLANs, because each spanning tree instance costs bandwidth and processing resources.

In the following illustration, three VLANs are mapped to two Multiple Spanning Tree instances (MSTI). VLAN 100 traffic takes a different path than VLAN 200 and 300 traffic. The behavior demonstrates how you can use MSTP to achieve load balancing.

Figure 31-1. MSTP with Three VLANs Mapped to Two Spanning Tree Instances

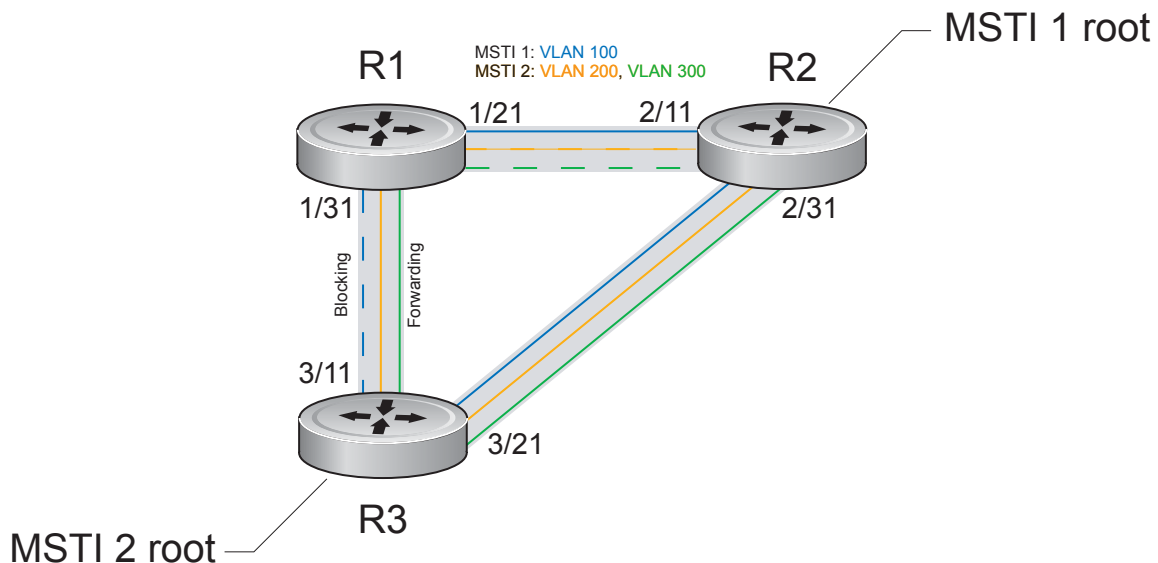

FTOS supports three other variations of Spanning Tree, as shown in [Table 44](#).

Table 31-1. FTOS Supported Spanning Tree Protocols

| Dell Force10 Term | IEEE Specification |
|---------------------------------|--------------------|
| Spanning Tree Protocol | 802.1d |
| Rapid Spanning Tree Protocol | 802.1w |
| Multiple Spanning Tree Protocol | 802.1s |
| Per-VLAN Spanning Tree Plus | Third Party |

Implementation Information

- The FTOS MSTP implementation is based on IEEE 802.1Q-2003, and interoperates only with bridges that also use this standard implementation.
- MSTP is compatible with STP and RSTP.
- FTOS supports only one MSTP region.
- When you enable MSTP, all ports in Layer 2 mode participate in MSTP.
- On the C-Series and S-Series, you can configure 64 MSTIs including the default instance 0 (CIST).

Configure Multiple Spanning Tree Protocol

Configuring Multiple Spanning Tree is a four-step process:

1. Configure interfaces for Layer 2. See [page 946](#).
2. Place the interfaces in VLANs.
3. Enable Multiple Spanning Tree Protocol. See [page 661](#).
4. Create Multiple Spanning Tree Instances, and map VLANs to them. See [page 662](#).

Related Configuration Tasks

- [Create Multiple Spanning Tree Instances on page 662](#)
- [Add and Remove Interfaces on page 661](#)
- [Influence MSTP Root Selection on page 663](#)
- [Interoperate with Non-FTOS Bridges on page 663](#)
- [Modify Global Parameters on page 664](#)
- [Modify Interface Parameters on page 665](#)
- [Configure an EdgePort on page 666](#)
- [Flush MAC Addresses after a Topology Change on page 667](#)
- [Debugging and Verifying MSTP Configuration on page 672](#)

- [Preventing Network Disruptions with BPDU Guard on page 953](#)
- [SNMP Traps for Root Elections and Topology Changes on page 815](#)
- [Configuring Spanning Trees as Hitless on page 959](#)

Enable Multiple Spanning Tree Globally

MSTP is not enabled by default. To enable MSTP:

| Step | Task | Command Syntax | Command Mode |
|------|---------------------------|-----------------------------|---------------|
| 1 | Enter PROTOCOL MSTP mode. | protocol spanning-tree mstp | CONFIGURATION |
| 2 | Enable MSTP. | no disable | PROTOCOL MSTP |

Verify that MSTP is enabled using the show config command from PROTOCOL MSTP mode, as shown in [Figure 31-2](#).

Figure 31-2. Verifying MSTP is Enabled

```
FTOS (conf) #protocol spanning-tree mstp
FTOS (config-mstp) #show config
!
protocol spanning-tree mstp
  no disable
FTOS#
```

When you enable MSTP, all physical, VLAN, and port-channel interfaces that are enabled and in Layer 2 mode are automatically part of the MSTI 0.

- Within an MSTI, only one path from any bridge to any other bridge is enabled.
- Bridges block a redundant path by disabling one of the link ports.

Add and Remove Interfaces

- To add an interface to the MSTP topology, configure it for Layer 2 and add it to a VLAN. If you previously disabled MSTP on the interface using the command `no spanning-tree 0`, re-enable it using the command `spanning-tree 0`.
- Remove an interface from the MSTP topology using the command `no spanning-tree 0` command. See also [Removing an Interface from the Spanning Tree Group on page 950](#) for BPDU Filtering behavior.

Create Multiple Spanning Tree Instances

A single MSTI provides no more benefit than RSTP. To take full advantage of MSTP you must create multiple MSTIs and map VLANs to them.

Create an MSTI using the command `msti` from PROTOCOL MSTP mode. Specify the keyword `vlan` followed by the VLANs that you want to participate in the MSTI, as shown in [Figure 31-3](#).

Figure 31-3. Mapping VLANs to MSTI Instances

```
FTOS(conf)#protocol spanning-tree mstp
FTOS(conf-mstp)#msti 1 vlan 100
FTOS(conf-mstp)#msti 2 vlan 200-300
FTOS(conf-mstp)#show config
!
protocol spanning-tree mstp
no disable
MSTI 1 VLAN 100
MSTI 2 VLAN 200-300
```

All bridges in the MSTP region must have the same VLAN-to-instance mapping. View to which instance a VLAN is mapped using the command `show spanning-tree mst vlan` from EXEC Privilege mode, as shown in [Figure 31-6](#).

View the forwarding/discarding state of the ports participating in an MSTI using the command `show spanning-tree msti` from EXEC Privilege mode, as shown in [Figure 31-4](#).

Figure 31-4. Viewing MSTP Port States

```
FTOS#show spanning-tree msti 1
MSTI 1 VLANs mapped 100

Root Identifier has priority 32768, Address 0001.e806.953e
Root Bridge hello time 2, max age 20, forward delay 15, max hops 19
Bridge Identifier has priority 32768, Address 0001.e80d.b6d6
Configured hello time 2, max age 20, forward delay 15, max hops 20
Current root has priority 32768, Address 0001.e806.953e
Number of topology changes 2, last change occurred 1d2h ago on Gi 1/21

Port 374 (GigabitEthernet 1/21) is root Forwarding
Port path cost 20000, Port priority 128, Port Identifier 128.374
Designated root has priority 32768, address 0001.e806.953e
Designated bridge has priority 32768, address 0001.e806.953e
Designated port id is 128.374, designated path cost 20000
Number of transitions to forwarding state 1
BPDU (MRecords): sent 93671, received 46843
The port is not in the Edge port mode

Port 384 (GigabitEthernet 1/31) is alternate Discarding
Port path cost 20000, Port priority 128, Port Identifier 128.384
Designated root has priority 32768, address 0001.e806.953e
Designated bridge has priority 32768, address 0001.e809.c24a
Designated port id is 128.384, designated path cost 20000
Number of transitions to forwarding state 1
BPDU (MRecords): sent 39291, received 7547
The port is not in the Edge port mode
```

Influence MSTP Root Selection

MSTP determines the root bridge, but you can assign one bridge a lower priority to increase the probability that it will become the root bridge.

To change the bridge priority:

| Task | Command Syntax | Command Mode |
|---|---|---------------|
| Assign a number as the bridge priority. A lower number increases the probability that the bridge becomes the root bridge. Range: 0 to 61440, in increments of 4096 Default: 32768 | <code>msti instance bridge-priority priority</code> | PROTOCOL MSTP |

The simple configuration [Figure 31-1](#) by default yields the same forwarding path for both MSTIs. [Figure 31-5](#), shows how R3 is assigned bridge priority 0 for MSTI 2, which elects a different root bridge than MSTI 2. View the bridge priority using the command `show config` from PROTOCOL MSTP mode, also shown in [Figure 31-5](#).

Figure 31-5. Changing the Bridge Priority

```
R3(conf-mstp)#msti 2 bridge-priority 0
1d2h51m: %RPM0-P:RP2 %SPANMGR-5-STP ROOT CHANGE: MSTP root changed for instance 2. My
Bridge ID: 0:0001.e809.c24a Old Root: 32768:0001.e806.953e New Root: 0:0001.e809.c24a

R3(conf-mstp)#show config
!
protocol spanning-tree mstp
no disable
MSTI 1 VLAN 100
MSTI 2 VLAN 200,300
MSTI 2 bridge-priority 0
```

Interoperate with Non-FTOS Bridges

FTOS supports only one MSTP region. A region is a combination of three unique qualities:

- **Name** is a mnemonic string you assign to the region. The default region name on FTOS is null.
- **Revision** is a two-byte number. The default revision number on FTOS is 0.
- **VLAN-to-instance mapping** is the placement of a VLAN in an MSTI.

For a bridge to be in the same MSTP region as another, all three of these qualities must match exactly. The default values for name and revision will match on all Dell Force10 FTOS equipment. If you have non-FTOS equipment that will participate in MSTP, ensure these values to match on all the equipment.



Note: Some non-FTOS equipment may implement a non-null default region name. SFTOS, for example, uses the Bridge ID, while others may use a MAC address.

To change the region name or revision:

| Task | Command Syntax | Command Mode |
|--|------------------------|---------------|
| Change the region name. | name <i>name</i> | PROTOCOL MSTP |
| Change the region revision number. <ul style="list-style-type: none"> Range: 0 to 65535 Default: 0 | revision <i>number</i> | PROTOCOL MSTP |

View the current region name and revision using the command `show spanning-tree mst configuration` from EXEC Privilege mode, as shown in [Figure 31-6](#).

Figure 31-6. Viewing the MSTP Region Name and Revision

```
FTOS (conf-mstp) #name my-mstp-region
FTOS (conf-mstp) #exit
FTOS (conf) #do show spanning-tree mst config
MST region name: my-mstp-region
Revision: 0
MSTI    VID
  1      100
  2      200-300
```

Modify Global Parameters

The root bridge sets the values for forward-delay, hello-time, max-age, and max-hops and overwrites the values set on other MSTP bridges.

- **Forward-delay** is the amount of time an interface waits in the Listening State and the Learning State before it transitions to the Forwarding State.
- **Hello-time** is the time interval in which the bridge sends MSTP Bridge Protocol Data Units (BPDUs).
- **Max-age** is the length of time the bridge maintains configuration information before it refreshes that information by recomputing the MST topology.
- **Max-hops** is the maximum number of hops a BPDU can travel before a receiving switch discards it.



Note: Dell Force10 recommends that only experienced network administrators change MSTP parameters. Poorly planned modification of MSTP parameters can negatively impact network performance.

To change MSTP parameters, use the following commands on the root bridge:

| Task | Command Syntax | Command Mode |
|---|---|---------------|
| Change the forward-delay parameter. • Range: 4 to 30 • Default: 15 seconds | <code>forward-delay <i>seconds</i></code> | PROTOCOL MSTP |
| Change the hello-time parameter. Note: With large configurations (especially those with more ports) Dell Force10 recommends that you increase the hello-time. Range: 1 to 10 Default: 2 seconds | <code>hello-time <i>seconds</i></code> | PROTOCOL MSTP |
| Change the max-age parameter. Range: 6 to 40 Default: 20 seconds | <code>max-age <i>seconds</i></code> | PROTOCOL MSTP |
| Change the max-hops parameter. Range: 1 to 40 Default: 20 | <code>max-hops <i>number</i></code> | PROTOCOL MSTP |

View the current values for MSTP parameters using the `show running-config spanning-tree mstp` command from EXEC privilege mode.

Figure 31-7. Viewing the Current Values for MSTP Parameters

```

FTOS(conf-mstp)#forward-delay 16
FTOS(conf-mstp)#exit
FTOS(conf)#do show running-config spanning-tree mstp
!
protocol spanning-tree mstp
no disable
name my-mstp-region
MSTI 1 VLAN 100
MSTI 2 VLAN 200-300
forward-delay 16
MSTI 2 bridge-priority 4096
FTOS(conf)#
  
```

Modify Interface Parameters

You can adjust two interface parameters to increase or decrease the probability that a port becomes a forwarding port:

- **Port cost** is a value that is based on the interface type. The greater the port cost, the less likely the port will be selected to be a forwarding port.
- **Port priority** influences the likelihood that a port will be selected to be a forwarding port in case that several ports have the same port cost.

Table 31-2 lists the default values for port cost by interface.

Table 31-2. MSTP Default Port Cost Values

| Port Cost | Default Value |
|--|---------------|
| 100-Mb/s Ethernet interfaces | 200000 |
| 1-Gigabit Ethernet interfaces | 20000 |
| 10-Gigabit Ethernet interfaces | 2000 |
| Port Channel with 100 Mb/s Ethernet interfaces | 180000 |
| Port Channel with 1-Gigabit Ethernet interfaces | 18000 |
| Port Channel with 10-Gigabit Ethernet interfaces | 1800 |

To change the port cost or priority of an interface:

| Task | Command Syntax | Command Mode |
|--|--|--------------|
| Change the port cost of an interface. Range: 0 to 200000 Default: see Table 31-2 . | <code>spanning-tree msti <i>number</i> cost <i>cost</i></code> | INTERFACE |
| Change the port priority of an interface. Range: 0 to 240, in increments of 16 Default: 128 | <code>spanning-tree msti <i>number</i> priority <i>priority</i></code> | INTERFACE |

View the current values for these interface parameters using the command `show config` from INTERFACE mode. See [Figure 31-8](#).

Configure an EdgePort

The EdgePort feature enables interfaces to begin forwarding traffic approximately 30 seconds sooner. In this mode an interface forwards frames by default until it receives a BPDU that indicates that it should behave otherwise; it does not go through the Learning and Listening states. The `bpduguard shutdown-on-violation` option causes the interface hardware to be shutdown when it receives a BPDU. When only `bpduguard` is implemented, although the interface is placed in an Error Disabled state when receiving the BPDU, the physical interface remains up and spanning-tree will drop packets in the hardware after a BPDU violation. BPDUs are dropped in the software after receiving the BPDU violation. This feature is the same as PortFast mode in Spanning Tree.



Caution: Configure EdgePort only on links connecting to an end station. EdgePort can cause loops if it is enabled on an interface connected to a network.

To enable EdgePort on an interface, use the following command:

| Task | Command Syntax | Command Mode |
|----------------------------------|--|--------------|
| Enable EdgePort on an interface. | spanning-tree mstp edge-port [bpduguard shutdown-on-violation] | INTERFACE |

Verify that EdgePort is enabled on a port using the command `show config` from the INTERFACE mode, as shown in [Figure 31-8](#).

FTOS Behavior: Regarding bpduguard shutdown-on-violation behavior:

- 1 If the interface to be shutdown is a port channel then all the member ports are disabled in the hardware.
- 2 When a physical port is added to a port channel already in error disable state, the new member port will also be disabled in the hardware.
- 3 When a physical port is removed from a port channel in error disable state, the error disabled state is cleared on this physical port (the physical port will be enabled in the hardware).
- 4 The `reset linecard` command does not clear the error disabled state of the port or the hardware disabled state. The interface continues to be disabled in the hardware.

The error disabled state can be cleared with any of the following methods:

- Perform a shutdown command on the interface.
- Disable the shutdown-on-violation command on the interface (`no spanning-tree stp-id portfast [bpduguard | [shutdown-on-violation]]`).
- Disable spanning tree on the interface (`no spanning-tree` in INTERFACE mode).
- Disabling global spanning tree (`no spanning-tree` in CONFIGURATION mode).

Figure 31-8. Configuring EdgePort

```
FTOS(conf-if-gi-3/41)#spanning-tree mstp edge-port
FTOS(conf-if-gi-3/41)#show config
!
interface GigabitEthernet 3/41
 no ip address
 switchport
 spanning-tree mstp edge-port
 spanning-tree MSTI 1 priority 144
 no shutdown
FTOS(conf-if-gi-3/41)#
```

Flush MAC Addresses after a Topology Change

FTOS has an optimized MAC address flush mechanism for RSTP, MSTP, and PVST+ that flushes addresses only when necessary, which allows for faster convergence during topology changes. However, you may activate the flushing mechanism defined by 802.1Q-2003 using the command `tc-flush-standard`, which flushes MAC addresses upon every topology change notification. View the enable status of this feature using the command `show running-config spanning-tree mstp` from EXEC Privilege mode.

MSTP Sample Configurations

The running-configurations in [Figure 31-10](#), [Figure 31-11](#), and [Figure 31-11](#) support the topology shown in [Figure 31-9](#). The configurations are from FTOS systems. An S50 system using SFTOS, configured as shown [Figure 31-13](#), could be substituted for an FTOS router in this sample following topology and MSTP would function as designed.

Figure 31-9. MSTP with Three VLANs Mapped to Two Spanning Tree Instances

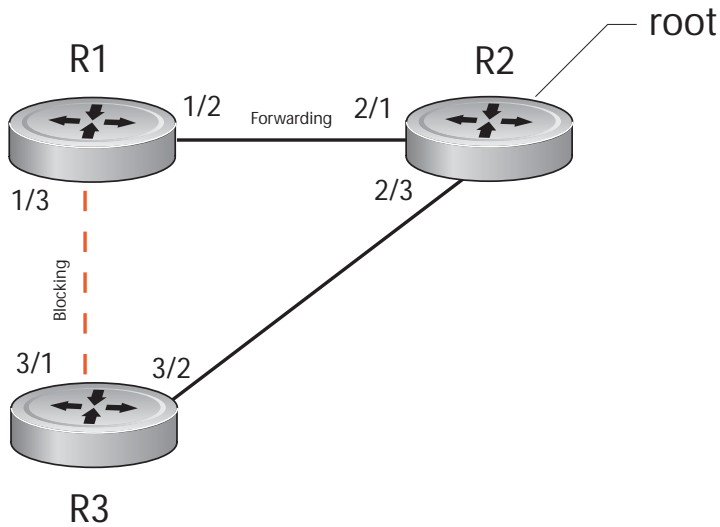

Figure 31-10. Router 1 Running-configuration

```
protocol spanning-tree mstp
no disable
name Tahiti
revision 123
MSTI 1 VLAN 100
MSTI 2 VLAN 200,300
!
interface GigabitEthernet 1/21
no ip address
switchport
no shutdown
!
interface GigabitEthernet 1/31
no ip address
switchport
no shutdown
!
interface Vlan 100
no ip address
tagged GigabitEthernet 1/21,31
no shutdown
!
interface Vlan 200
no ip address
tagged GigabitEthernet 1/21,31
no shutdown
!
interface Vlan 300
no ip address
tagged GigabitEthernet 1/21,31
no shutdown
```

The diagram shows three groups of configuration lines, each with a red bracket on the right side pointing to a red arrow and explanatory text:

- Group 1:** Lines from `protocol spanning-tree mstp` to `MSTI 2 VLAN 200,300`. The arrow points to the text: "Enable MSTP globally", "Set Region Name and Revision", and "Map MSTP Instances to VLANs".
- Group 2:** Lines from `interface GigabitEthernet 1/21` to `interface GigabitEthernet 1/31`. The arrow points to the text: "Assign Layer-2 interfaces to MSTP topology".
- Group 3:** Lines from `interface Vlan 100` to `interface Vlan 300`. The arrow points to the text: "Create VLANs mapped to MSTP Instances" and "Tag interfaces to VLANs".

Figure 31-11. Router 2 Running-configuration

```
protocol spanning-tree mstp
  no disable
  name Tahiti
  revision 123
  MSTI 1 VLAN 100
  MSTI 2 VLAN 200,300
!
interface GigabitEthernet 2/11
  no ip address
  switchport
  no shutdown
!
interface GigabitEthernet 2/31
  no ip address
  switchport
  no shutdown
!
interface Vlan 100
  no ip address
  tagged GigabitEthernet 2/11,31
  no shutdown
!
interface Vlan 200
  no ip address
  tagged GigabitEthernet 2/11,31
  no shutdown
!
interface Vlan 300
  no ip address
  tagged GigabitEthernet 2/11,31
  no shutdown
```

Enable MSTP globally
Set Region Name and Revision
Map MSTP Instances to VLANs

Assign Layer-2 interfaces
to MSTP topology

Create VLANs mapped to MSTP Instances
Tag interfaces to VLANs

Figure 31-12. Router 3 Running-configuration

```
protocol spanning-tree mstp
no disable
name Tahiti
revision 123
MSTI 1 VLAN 100
MSTI 2 VLAN 200,300
!
interface GigabitEthernet 3/11
no ip address
switchport
no shutdown
!
interface GigabitEthernet 3/21
no ip address
switchport
no shutdown
!
interface Vlan 100
no ip address
tagged GigabitEthernet 3/11,21
no shutdown
!
interface Vlan 200
no ip address
tagged GigabitEthernet 3/11,21
no shutdown
!
interface Vlan 300
no ip address
tagged GigabitEthernet 3/11,21
no shutdown
```

The diagram shows three groups of configuration lines, each enclosed in a red bracket on the right side. Red arrows point from these brackets to explanatory text on the right. The first group includes the global MSTP configuration and MSTI mappings. The second group includes the configuration for Layer-2 interfaces. The third group includes the configuration for VLANs.

Enable MSTP globally
Set Region Name and Revision
Map MSTP Instances to VLANs

Assign Layer-2 interfaces
to MSTP topology

Create VLANs mapped to MSTP Instances
Tag interfaces to VLANs

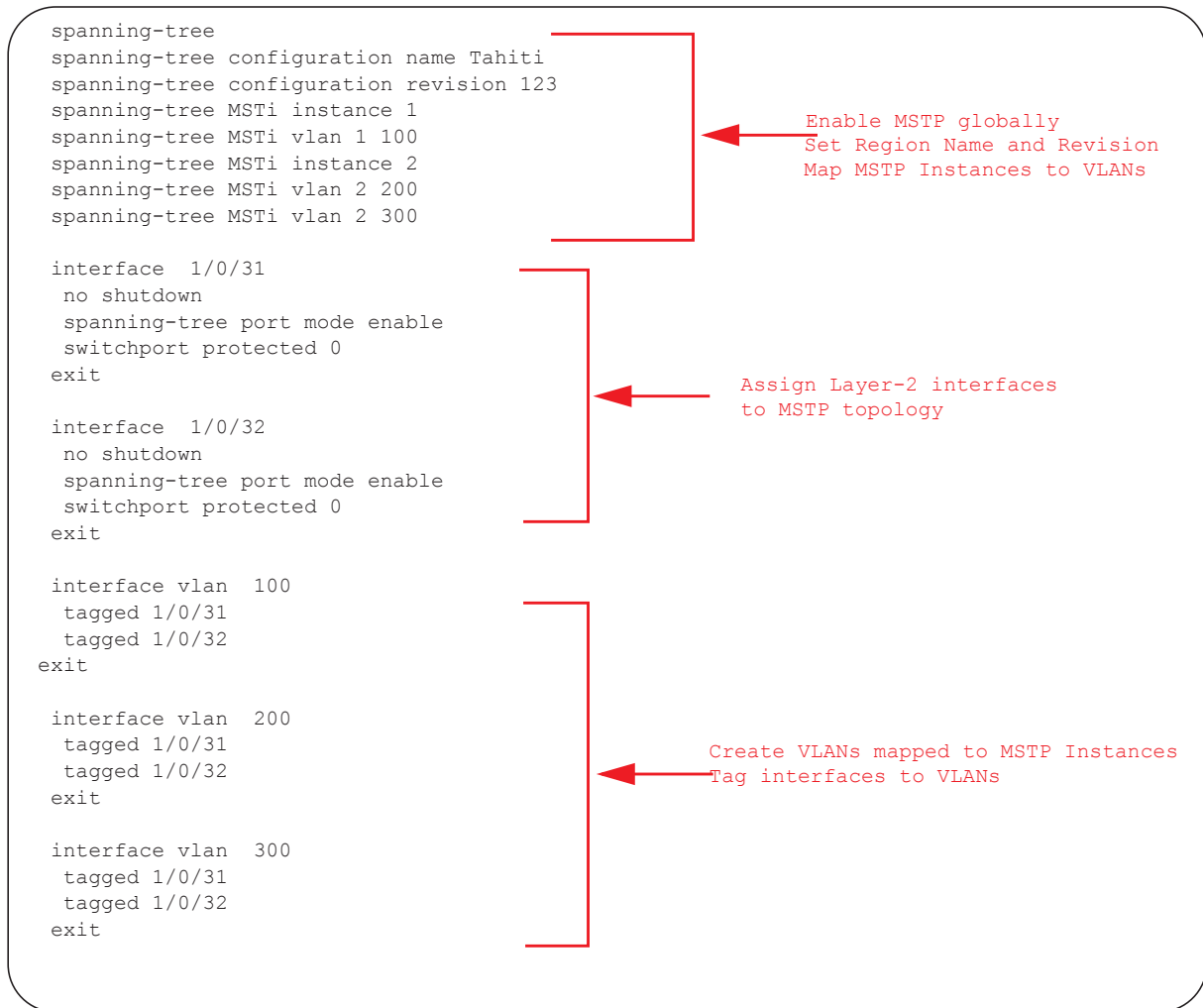
Figure 31-13. SFTOS Example Running-Configuration

Debugging and Verifying MSTP Configuration

Display BPDUs using the command `debug spanning-tree mstp bpd` from EXEC Privilege mode. Display MSTP-triggered topology change messages `debug spanning-tree mstp events`.

Figure 31-14. Displaying BPDUs and Events

```
FTOS#debug spanning-tree mstp bpdud
1w1d17h : MSTP: Sending BPDU on Gi 1/31 :
ProtId: 0, Ver: 3, Bpdu Type: MSTP, Flags 0x68
CIST Root Bridge Id: 32768:0001.e806.953e, Ext Path Cost: 20000
Regional Bridge Id: 32768:0001.e809.c24a, CIST Port Id: 128:384
Msg Age: 2, Max Age: 20, Hello: 2, Fwd Delay: 15, Ver1 Len: 0, Ver3 Len: 96
Name: my-mstp-region, Rev: 0, Int Root Path Cost: 20000
Rem Hops: 19, Bridge Id: 32768:0001.e80d.b6d6
E1200#1w1d17h : INST 1: Flags: 0x28, Reg Root: 32768:0001.e809.c24a, Int Root Co
    Brg/Port Prio: 32768/128, Rem Hops: 19
INST 2: Flags: 0x68, Reg Root: 4096:0001.e809.c24a, Int Root Cost: 20000
    Brg/Port Prio: 32768/128, Rem Hops: 19
[output omitted]
FTOS#debug spanning-tree mstp events
1w1d17h : MSTP: TC flag set in the incoming BPDU on port Gi 1/31 for instance 0

1w1d17h : MSTP: TC flag set in the incoming BPDU on port Gi 1/31 for instance 0

1w1d17h : MSTP: TC flag set in the incoming BPDU on port Gi 1/31 for instance 0
```

Examine your individual routers to ensure all the necessary parameters match.

1. Region Name
2. Region Version
3. VLAN to Instance mapping

The show spanning-tree mst commands will show various portions of the MSTP configuration. To view the overall MSTP configuration on the router, use the show running-configuration spanning-tree mstp in the EXEC Privilege mode (output sample shown in [Figure 31-15](#)).

Use the debug spanning-tree mstp bpdud command to monitor and verify that the MSTP configuration is connected and communicating as desired (output sample shown in [Figure 31-16](#)).

Key items to look for in the debug report:

- MSTP flags indicate communication received from the same region.
 - In [Figure 31-16](#), the output shows that the MSTP routers are located in the same region.
 - Does the debug log indicate that packets are coming from a “Different Region” ([Figure 31-17](#))? If so, one of the key parameters is not matching.
- MSTP Region Name and Revision
 - The configured name and revisions *must* be identical among all the routers.
 - Is the Region name blank? That may mean that a name was configured on one router and but was not configured or was configured differently on another router (spelling and capitalization counts).
- MSTP Instances.
 - Use the show commands to verify the VLAN to MSTP Instance mapping.
 - Are there “extra” MSTP Instances in the Sending or Received logs? That may mean that an additional MSTP Instance was configured on one router but not the others.

Figure 31-15. Sample Output for show running-configuration spanning-tree mstp command

```

FTOS#show run spanning-tree mstp
!
protocol spanning-tree mstp
  name Tahiti
  revision 123
  MSTI 1 VLAN 100
  MSTI 2 VLAN 200,300

```

Figure 31-16. Displaying BPDUs and Events - Debug Log of Successful MSTP Configuration

```

FTOS#debug spanning-tree mstp bpdu
MSTP debug bpdu is ON
FTOS#
4w0d4h : MSTP: Sending BPDU on Gi 2/21 :
ProtId: 0, Ver: 3, Bpdu Type: MSTP, Flags 0x6e
CIST Root Bridge Id: 32768:0001.e806.953e, Ext Path Cost: 0
Regional Bridge Id: 32768:0001.e806.953e, CIST Port Id: 128:470
Msg Age: 0, Max Age: 20, Hello: 2, Fwd Delay: 15, Ver1 Len: 0, Ver3 Len: 96
Name: Tahiti, Rev: 123, Int Root Path Cost: 0
Rem Hops: 20, Bridge Id: 32768:0001.e806.953e
4w0d4h : INST 1: Flags: 0x6e, Reg Root: 32768:0001.e806.953e, Int Root Cost: 0
      Brg/Port Prio: 32768/128, Rem Hops: 20
INST 2: Flags: 0x6e, Reg Root: 32768:0001.e806.953e, Int Root Cost: 0
      Brg/Port Prio: 32768/128, Rem Hops: 20

4w0d4h : MSTP: Received BPDU on Gi 2/21 :
ProtId: 0, Ver: 3, Bpdu Type: MSTP, Flags 0x78 Same Region ← Indicates MSTP
CIST Root Bridge Id: 32768:0001.e806.953e, Ext Path Cost: 0          routers are in the
Regional Bridge Id: 32768:0001.e806.953e, CIST Port Id: 128:470      (single) region
Msg Age: 0, Max Age: 20, Hello: 2, Fwd Delay: 15, Ver1 Len: 0, Ver3 Len: 96
Name: Tahiti, Rev: 123, Int Root Path Cost: 0
Rem Hops: 19, Bridge Id: 32768:0001.e8d5.cbbd
4w0d4h : INST 1: Flags: 0x78, Reg Root: 32768:0001.e806.953e, Int Root Cost: 0
      Brg/Port Prio: 32768/128, Rem Hops: 19
INST 2: Flags: 0x78, Reg Root: 32768:0001.e806.953e, Int Root Cost: 0
      Brg/Port Prio: 32768/128, Rem Hops: 19

```

MSTP Instance

MSTP Region name and revision

Figure 31-17. Displaying BPDUs and Events - Debug Log of Unsuccessful MSTP Configuration

```

4w0d4h : MSTP: Received BPDU on Gi 2/21 :
ProtId: 0, Ver: 3, Bpdu Type: MSTP, Flags 0x78 Different Region
CIST Root Bridge Id: 32768:0001.e806.953e, Ext Path Cost: 0
Regional Bridge Id: 32768:0001.e806.953e, CIST Port Id: 128:470
Msg Age: 0, Max Age: 20, Hello: 2, Fwd Delay: 15, Ver1 Len: 0, Ver
Name: Tahiti, Rev: 123, Int Root Path Cost: 0
Rem Hops: 20, Bridge Id: 32768:0001.e8d5.cbbd
4w0d4h : INST 1: Flags: 0x70, Reg Root: 32768:0001.e8d5.cbbd, Int
      Brg/Port Prio: 32768/128, Rem Hops: 20
INST 2: Flags: 0x70, Reg Root: 32768:0001.e8d5.cbbd, Int Root Cost
      Brg/Port Prio: 32768/128, Rem Hops: 20

```

Indicates MSTP routers are in different regions and are not communicating with each other

Multicast Features

Multicast Features are supported on platforms: e C S **S4810** **S4820T**

This chapter contains the following sections:

- [Enable IP Multicast on page 675](#)
- [Multicast with ECMP on page 676](#)
- [First Packet Forwarding for Lossless Multicast on page 677](#)
- [Multicast Policies on page 678](#)
- [Multicast Traceroute on page 685](#)

FTOS supports the following multicast protocols:

- [PIM Sparse-Mode \(PIM-SM\) on page 717](#)
- [Internet Group Management Protocol \(IGMP\) on page 423](#)
- [Multicast Source Discovery Protocol \(MSDP\) on page 631](#)

Implementation Information

- Multicast is supported on secondary IP addresses on the **S4810** and **S4820T** platforms.

Enable IP Multicast

[Enable IP Multicast](#) is supported on platforms C e S

Prior to enabling any multicast protocols, you must enable multicast routing.

| Task | Command Syntax | Command Mode |
|---------------------------|----------------------|---------------|
| Enable multicast routing. | ip multicast-routing | CONFIGURATION |

Multicast with ECMP

Dell Force10 multicast uses Equal-cost Multi-path (ECMP) routing to load-balance multiple streams across equal cost links. When creating the shared-tree Protocol Independent Multicast (PIM) uses routes from all configured routing protocols to select the best route to the rendezvous point (RP). If there are multiple, equal-cost paths, the PIM selects the route with the least number of currently running multicast streams. If multiple routes have the same number of streams, PIM selects the first equal-cost route returned by the Route Table Manager (RTM).

In [Figure 32-1](#), the receiver joins three groups. The last-hop DR initially has two equal-cost routes to the RP with no streams, so it non-deterministically selects Route 1 for the Group 1 IGMP Join message. Route 1 then has one stream associated with it, so the last-hop DR sends the Group 2 Join by Route 2. It then non-deterministically selects Route 2 for the Group 3 Join since both routes already have one multicast stream.

Figure 32-1. Multicast with ECMP

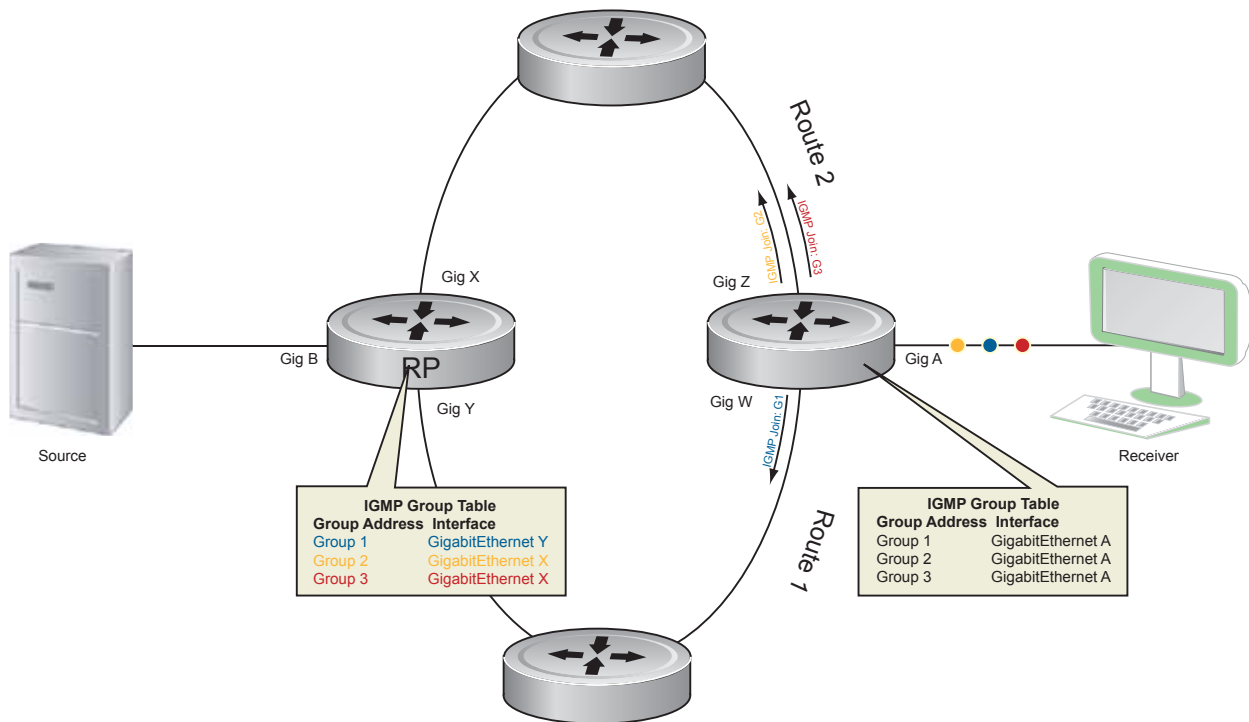

Implementation Information

- Because protocol control traffic in FTOS is redirected using the MAC address, and multicast control traffic and multicast data traffic might map to the same MAC address, FTOS might forward data traffic with certain MAC addresses to the CPU in addition to control traffic.

As the upper five bits of an IP Multicast address are dropped in the translation, 32 different multicast group IDs all map to the same Ethernet address. For example, 224.0.0.5 is a well known IP address for OSPF that maps to the multicast MAC address 01:00:5e:00:00:05. However, 225.0.0.5, 226.0.0.5, etc., map to the same multicast MAC address. The Layer 2 FIB alone cannot differentiate multicast control traffic multicast data traffic with the same address, so if you use IP address 225.0.0.5 for data traffic, both the multicast data and OSPF control traffic match the same entry and are forwarded to the CPU. Therefore, do not use well-known protocol multicast addresses for data transmission, such as the ones below.

| Protocol | Ethernet Address |
|----------|--|
| OSPF | 01:00:5e:00:00:05 01:00:5e:00:00:06 |
| RIP | 01:00:5e:00:00:09 |
| NTP | 01:00:5e:00:01:01 |
| VRRP | 01:00:5e:00:00:12 |
| PIM-SM | 01:00:5e:00:00:0d |

- The FTOS implementation of MTRACE is in accordance with IETF draft *draft-fenner-traceroute-ipm*.
- Multicast is not supported on secondary IP addresses.
- Egress L3 ACL is not applied to multicast data traffic if multicast routing is enabled.

First Packet Forwarding for Lossless Multicast

Beginning with FTOS version 7.8.1.0 for the E-Series TeraScale, version 8.2.1.0 for E-Series ExaScale, and version 8.3.1.0 on all other FTOS platforms, all initial multicast packets are forwarded to receivers to achieve lossless multicast.

In previous versions, when the Dell Force10 system is an RP, all initial packets are dropped until PIM creates an (S,G) entry. When the system is an RP and a Source DR, these initial packet drops represent a loss of native data, and when the system is an RP only, the initial packets drops represent a loss of register packets.

Both scenarios might be unacceptable depending on the multicast application. Beginning with the FTOS versions above, when the Dell Force10 system is the RP, and has receivers for a group G, it forwards all initial multicast packets for the group based on the (*,G) entry rather than discarding them until the (S,G) entry is created, making Dell Force10 systems suitable for applications sensitive to multicast packet loss.



Note: When a source begins sending traffic, the Source DR forwards the initial packets to the RP as encapsulated registered packets. These packets are forwarded via the soft path at a maximum rate of 70 packets/second. Incoming packets beyond this rate are dropped.

Multicast Policies

FTOS offers parallel Multicast features for IPv4 and IPv6.

- [IPv4 Multicast Policies on page 678](#)
- [IPv6 Multicast Policies on page 683](#)

IPv4 Multicast Policies

- [Limit the Number of Multicast Routes on page 678](#)
- [Prevent a Host from Joining a Group on page 679](#)
- [Rate Limit IGMP Join Requests on page 681](#)
- [Prevent a PIM Router from Forming an Adjacency on page 681](#)
- [Prevent a Source from Registering with the RP on page 681](#)
- [Prevent a PIM Router from Processing a Join on page 683](#)

Limit the Number of Multicast Routes

| Task | Command Syntax | Command Mode |
|---|--|---------------|
| Limit the total number of multicast routes on the system. | ip multicast-limit Range: 1-50000 Default: 15000 | CONFIGURATION |

When the limit is reached, FTOS does not process any IGMP or MLD joins to PIM—though it still processes leave messages—until the number of entries decreases below 95% of the limit. When the limit falls below 95% after hitting the maximum, the system begins relearning route entries through IGMP, MLD, and MSDP.

- If the limit is increased after it is reached, join subsequent join requests are accepted. In this case, you must increase the limit by at least 10% for IGMP and MLD to resume.
- If the limit is decreased after it is reached, FTOS does not clear the existing sessions. Entries are cleared upon a timeout (you may also clear entries using `clear ip mroute`).



Note: FTOS waits at least 30 seconds between stopping and starting IGMP join processing. You may experience this delay when manipulating the limit after it is reached.

When the multicast route limit is reached, FTOS displays [Message 1](#).

Message 1 Multicast Route Limit Error

```
3w1d13h: %RPM0-P:RP2 %PIM-3-PIM_TIB_LIMIT: PIM TIB limit reached. No new routes will
be learnt until TIB level falls below low watermark.
3w1d13h: %RPM0-P:RP2 %PIM-3-PIM_TIB_LIMIT: PIM TIB below low watermark. Route learning
will begin.
```



Note: The IN-L3-McastFib CAM partition is used to store multicast routes and is a separate hardware limit that exists per port-pipe. Any software-configured limit might be superseded by this hardware space limitation. The opposite is also true, the CAM partition might not be exhausted at the time the system-wide route limit set by the `ip multicast-limit` is reached.

Prevent a Host from Joining a Group

You can prevent a host from joining a particular group by blocking specific IGMP reports. Create an extended access list containing the permissible source-group pairs. Use the command `ip igmp access-group access-list-name` from `INTERFACE` mode to apply the access list.



Note: For rules in IGMP access lists, *source* is the multicast source, not the source of the IGMP packet. For IGMPv2, use the keyword `any` for *source* (as shown in [Figure 32-2](#)), since IGMPv2 hosts do not know in advance who the source is for the group in which they are interested.

FTOS Behavior: Do not enter the command `ip igmp access-group` before creating the access-list. If you do, upon entering your first *deny* rule, FTOS clears multicast routing table and re-learns all groups, even those not covered by the rules in the access-list, because there is an implicit *deny all* rule at the end of all access-lists. Therefore, configuring an IGMP join request filter in this order might result in data loss. If you must enter the command `ip igmp access-group` before creating the access-list, prevent FTOS from clearing the routing table by entering a *permit any* rule with high sequence number before you enter any other rules.

In [Figure 32-2](#), VLAN 400 is configured with an access list to permit only IGMP reports for group 239.0.0.1. Though Receiver 2 sends a membership report for groups 239.0.0.1 and 239.0.0.2, a multicast routing table entry is created only for group 239.0.0.1. VLAN 300 has no access list limiting Receiver 1, so both IGMP reports are accepted, and two corresponding entries are created in the routing table.

Figure 32-2. Preventing a Host from Joining a Group

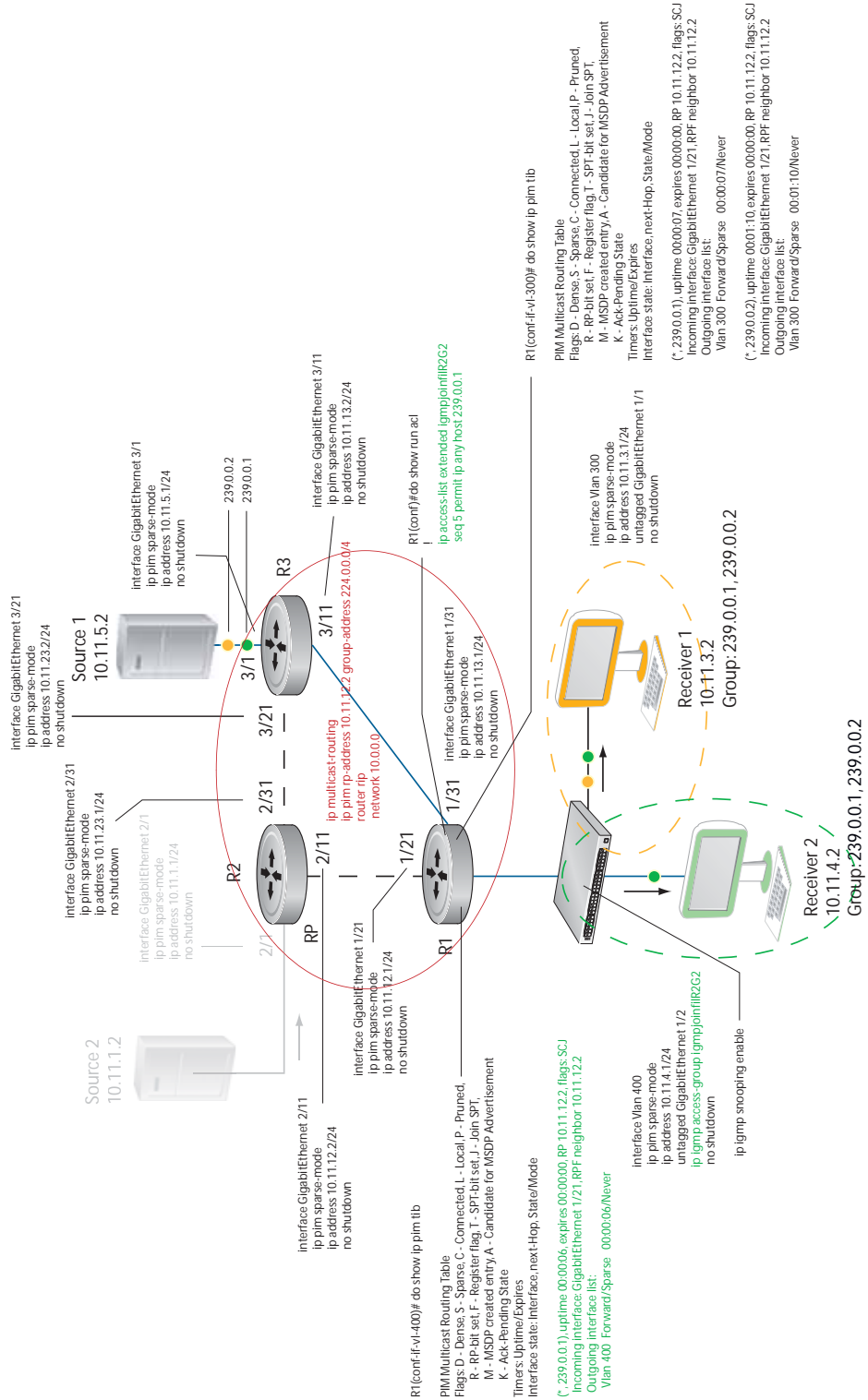

Rate Limit IGMP Join Requests

If you expect a burst of IGMP Joins, protect the IGMP process from overload by limiting that rate at which new groups can be joined using the command `ip igmp group-join-limit` from INTERFACE mode. Hosts whose IGMP requests are denied will use the retry mechanism built-in to IGMP so that they're membership is delayed rather than permanently denied.

View the enable status of this feature using the command `show ip igmp interface` from EXEC Privilege mode.

Prevent a PIM Router from Forming an Adjacency

To prevent a router from participating in Protocol Independent Multicast (PIM) (for example, to configure stub multicast routing), use the `ip pim neighbor-filter` command from INTERFACE mode.

Prevent a Source from Registering with the RP

Use the command `ip pim register-filter` from CONFIGURATION mode to prevent a source from transmitting to a particular group. This command prevents the PIM source DR from sending register packets to RP for the specified multicast source and group; if the source DR never sends register packets to the RP, no hosts can ever discover the source and create an SPT to it.

In [Figure 32-3](#), Source 1 and Source 2 are both transmitting packets for groups 239.0.0.1 and 239.0.0.2. R3 has a PIM register filter that only permits packets destined for group 239.0.0.2. An entry is created for group 239.0.0.1 in the routing table, but no outgoing interfaces are listed. R2 has no filter, so it is allowed to forward both groups. As a result, Receiver 1 receives only one transmission, while Receiver 2 receives duplicate transmissions.

Figure 32-3. Preventing a Source from Transmitting to a Group

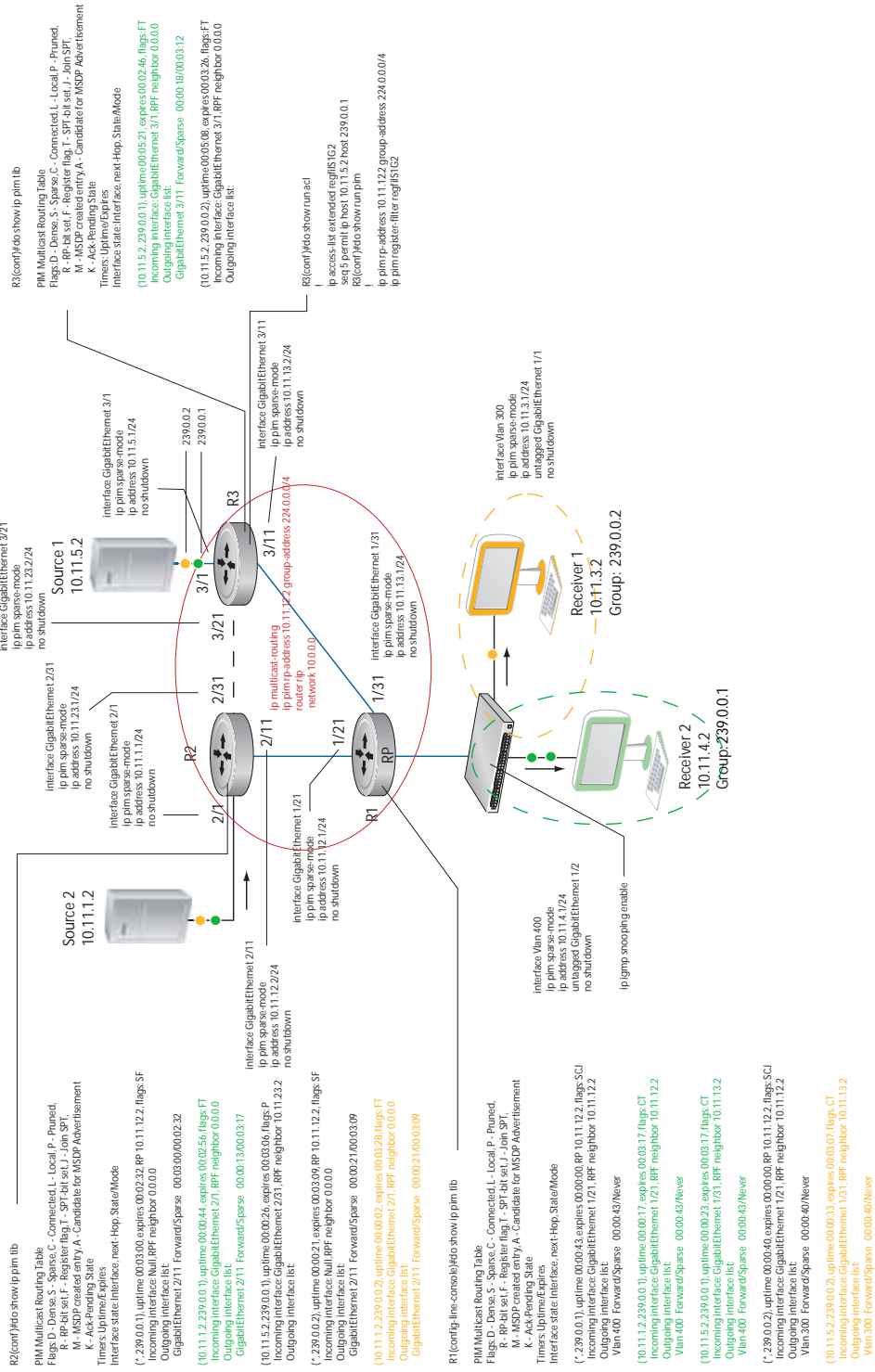

Prevent a PIM Router from Processing a Join

Permit or deny PIM Join/Prune messages on an interface using an extended IP access list. Use the command **ip pim join-filter** to prevent the PIM SM router from creating state based on multicast source and/or group.



Note: Dell Force10 recommends that you do not use the **ip pim join-filter** command on an interface between a source and the RP router. Use of this command in this scenario could cause problems with the PIM-SM source registration process resulting in excessive traffic being sent to the CPU of both the RP and PIM DR of the source.

Excessive traffic is generated when the join process from the RP back to the source is blocked due to a new source group being permitted in the join-filter. This results in the new source becoming stuck in registering on the DR and the continuous generation of UDP-encapsulated registration messages between the DR and RP routers which are being sent to the CPU.

IPv6 Multicast Policies

IPv6 Multicast Policies is available only on platform: 

- [Limit the Number of IPv6 Multicast Routes on page 683](#)
- [Prevent an IPv6 Neighbor from Forming an Adjacency on page 684](#)
- [Prevent an IPv6 Source from Registering with the RP on page 684](#)
- [Prevent an IPv6 PIM Router from Processing an IPv6 Join on page 684](#)

Limit the Number of IPv6 Multicast Routes

You can limit the total number of IPv6 multicast routes on the system. The maximum number of multicast entries allowed on each line card is determined by the CAM profile. Multicast routes are stored in the IN-V6-McastFib CAM region, which has a fixed number of entries. Any limit configured via the CLI is superseded by this hardware limit. The opposite is also true; the CAM might not be exhausted at the time the CLI-configured route limit is reached.

| Task | Command Syntax | Command Mode |
|--|--|---------------|
| Limit the total number of IPv6 multicast routes on the system. | ipv6 multicast-limit Range: 1-50000 Default: 15000 | CONFIGURATION |

Prevent an IPv6 Neighbor from Forming an Adjacency

| Task | Command Syntax | Command Mode |
|--|--|---------------|
| Prevent a router from participating in PIM. | <code>ipv6 pim neighbor-filter <i>access-list</i></code> | CONFIGURATION |
| <pre>FTOS(conf)#ipv6 pim neighbor-filter NEIGH_ACL FTOS(conf)#ipv6 access-list NEIGH_ACL FTOS(conf-ipv6-acl)#show config ! ipv6 access-list NEIGH_ACL seq 5 deny ipv6 host fe80::201:e8ff:fe0a:5ad any seq 10 permit ipv6 any any FTOS(conf-ipv6-acl)#</pre> | | |

Prevent an IPv6 Source from Registering with the RP

| Task | Command Syntax | Command Mode |
|---|--|---------------|
| Configured on the source DR, prevent the source DR from sending register packets to the RP for specific sources and groups. | <code>ipv6 pim register-filter <i>access-list</i></code> | CONFIGURATION |
| <pre>FTOS(conf)#ipv6 pim register-filter REG-FIL_ACL FTOS(conf)#ipv6 access-list REG-FIL_ACL FTOS(conf-ipv6-acl)#deny ipv6 165:87:34::10/128 ff0e::225:1:2:0/112 FTOS(conf-ipv6-acl)#permit ipv6 any any FTOS(conf-ipv6-acl)#exit</pre> | | |

Prevent an IPv6 PIM Router from Processing an IPv6 Join

| Task | Command Syntax | Command Mode |
|---|---|--------------|
| Permit or deny PIM Join/Prune messages on an interface using an access list. This command prevents the PIM-SM router from creating state based on multicast source and/or group. | <code>ipv6 pim join-filter <i>access-list</i> [in out]</code> | INTERFACE |
| <pre>FTOS(conf)#ipv6 access-list JOIN-FIL_ACL FTOS(conf-ipv6-acl)#permit ipv6 165:87:34::0/112 ff0e::225:1:2:0/112 FTOS(conf-ipv6-acl)#permit ipv6 any ff0e::230:1:2:0/112 FTOS(conf-ipv6-acl)#permit ipv6 165:87:32::0/112 any FTOS(conf-ipv6-acl)#exit FTOS(conf)#interface gigabitethernet 0/84 FTOS(conf-if-gi-0/84)#ipv6 pim join-filter JOIN-FIL_ACL in FTOS(conf-if-gi-0/84)#ipv6 pim join-filter JOIN-FIL_ACL out</pre> | | |

Multicast Traceroute

Multicast Traceroute is supported only on platform: 

MTRACE is an IGMP-based tool that prints that network path that a multicast packet takes from a source to a destination, for a particular group. FTOS has mtrace client and mtrace transmit functionality.

- **MTRACE Client**—an mtrace client transmits mtrace queries and prints out the details received responses.
- **MTRACE Transit**—when a Dell Force10 system is an intermediate router between the source and destination in an MTRACE query, FTOS computes the RPF neighbor for the source, fills in the request, and forwards the request to the RPF neighbor. While computing the RPF neighbor, static mroutes and mBGP routes are preferred over unicast routes. When a Dell Force10 system is the last hop to the destination, FTOS sends a response to the query.

| Task | Command Syntax | Command Mode |
|---|--|----------------|
| Print the network path that a multicast packet takes from a multicast source to receiver, for a particular group. | <code>mtrace <i>multicast-source-address</i> <i>multicast-receiver-address</i> <i>multicast-group-address</i></code> | EXEC Privilege |

Figure 32-4. Tracing a Multicast Route

```
FTOS#mtrace 10.11.5.2 10.11.3.2 239.0.0.1
Type Ctrl-C to abort.
Mtrace from 10.11.5.2 to 10.11.3.2 via group 239.0.0.1
From source (?) to destination (?)
Querying full reverse path...
 0 10.11.3.2
-1 10.11.3.1 PIM Reached RP/Core [default]
-2 10.11.5.2
```

Open Shortest Path First (OSPFv2)

Open Shortest Path First (OSPFv2) is supported on the **S4810** **S4820T** platforms only.

This chapter includes the following topics:

- Protocol Overview
- Implementing OSPF with FTOS
 - Fast Convergence (OSPFv2, IPv4 only)
 - Multi-Process OSPF (OSPFv2, IPv4 only)
 - RFC-2328 Compliant OSPF Flooding
 - OSPF ACK Packing
 - OSPF Adjacency with Cisco Routers Configuration Information
 - Configuration Task List for OSPFv2 (OSPF for IPv4)
- Sample Configurations for OSPFv2

OSPF protocol standards are listed in the [Chapter 56, Standards Compliance](#) chapter.

Protocol Overview

Open Shortest Path First (OSPF) routing is a link-state routing protocol that calls for the sending of [Link-State Advertisements \(LSAs\)](#) to all other routers within the same [Autonomous System \(AS\) Areas](#). Information on attached interfaces, metrics used, and other variables is included in OSPF LSAs. As OSPF routers accumulate link-state information, they use the SPF algorithm (Shortest Path First algorithm) to calculate the shortest path to each node.

OSPF routers initially exchange HELLO messages to set up adjacencies with neighbor routers. The HELLO process is used to establish adjacencies between routers of the AS. It is not required that every router within the Autonomous System areas establish adjacencies. If two routers on the same subnet agree to become neighbors through the HELLO process, they begin to exchange network topology information in the form of Link State Advertisements (LSAs).

In OSPFv2 neighbors on broadcast and NBMA links are identified by their interface addresses, while neighbors on other types of links are identified by RID.

Autonomous System (AS) Areas

OSPF operate in a type of hierarchy. The largest entity within the hierarchy is the autonomous system (AS), which is a collection of networks under a common administration that share a common routing strategy. OSPF is an intra-AS (interior gateway) routing protocol, although it is capable of receiving routes from and sending routes to other ASs.

An AS can be divided into a number of areas, which are groups of contiguous networks and attached hosts. Routers with multiple interfaces can participate in multiple areas. These routers, Area Border Routers (ABRs), maintain separate databases for each area. Areas are a logical grouping of OSPF routers identified by an integer or dotted-decimal number.

Areas allow you to further organize your routers within in the AS. One or more areas are required within the AS. Areas are valuable in that they allow sub-networks to "hide" within the AS, thus minimizing the size of the routing tables on all routers. An area within the AS may not see the details of another Area's topology. AS areas are known by their area number or the router's IP address.

Figure 33-1. Autonomous System Areas

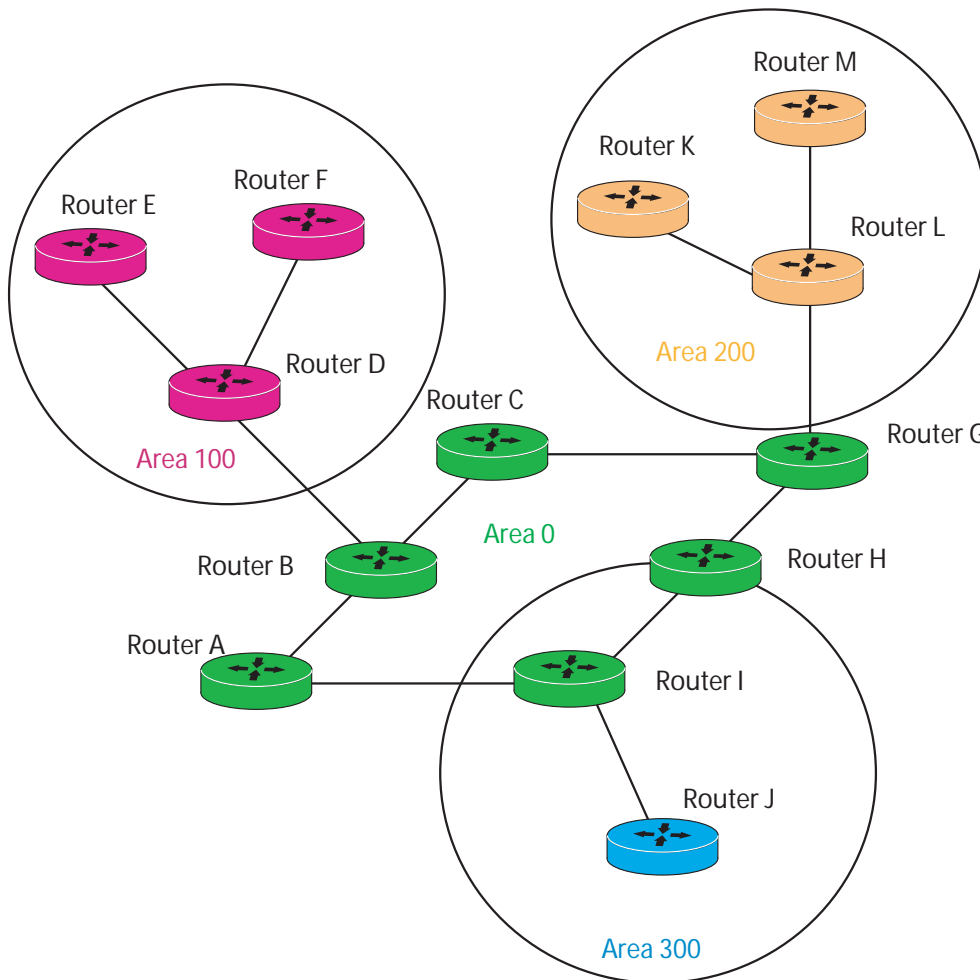

Area Types

The **Backbone** of the network is Area 0. It is also called Area 0.0.0.0 and is the core of any Autonomous System (AS). All other areas must connect to Area 0. Areas can be defined in such a way that the backbone is not contiguous. In this case, backbone connectivity must be restored through virtual links. Virtual links are configured between any backbone routers that share a link to a non-backbone area and function as if they were direct links.

An OSPF backbone is responsible for distributing routing information between areas. It consists of all Area Border Routers, networks not wholly contained in any area, and their attached routers.

The Backbone is the only area with a default area number. All other areas can have their Area ID assigned in the configuration.

Figure 33-1 shows Routers A, B, C, G, H, and I are the Backbone.

A **Stub Area** (SA) does not receive external route information, except for the default route. These areas do receive information from inter-area (IA) routes. Note that all routers within an assigned Stub area must be configured as stubby, and no generate LSAs that do not apply. For example, a Type 5 LSA is intended for external areas and the Stubby area routers may not generate external LSAs. Stubby areas cannot be traversed by a virtual link.

A **Not-So-Stubby Area** (NSSA) can import AS external route information and send it to the Backbone. It cannot receive external AS information from the Backbone or other areas. It can be traversed by a virtual link.

Totally Stubby Areas are referred to as No Summary areas in FTOS.

Networks and Neighbors

As a link-state protocol, OSPF sends routing information to other OSPF routers concerning the state of the links between them. The state (up or down) of those links is important.

Routers that share a link become neighbors on that segment. OSPF uses the hello protocol as a neighbor discovery and keep alive mechanism. After two routers are neighbors, they may proceed to exchange and synchronize their databases, which creates an adjacency.

Router Types

Router types are attributes of the OSPF process. A given physical router may be a part of one or more OSPF processes. For example, a router connected to more than one area, receiving routing from a BGP process connected to another AS acts as both an Area Border Router and an Autonomous System Router.

Each router has a unique ID, written in decimal format (A.B.C.D). The router ID does not have to be associated with a valid IP address. However, Dell Force10 recommends that the router ID and the router's IP address reflect each other, to make troubleshooting easier.

Figure 33-2 gives some examples of the different router designations.

Figure 33-2. OSPF Routing Examples

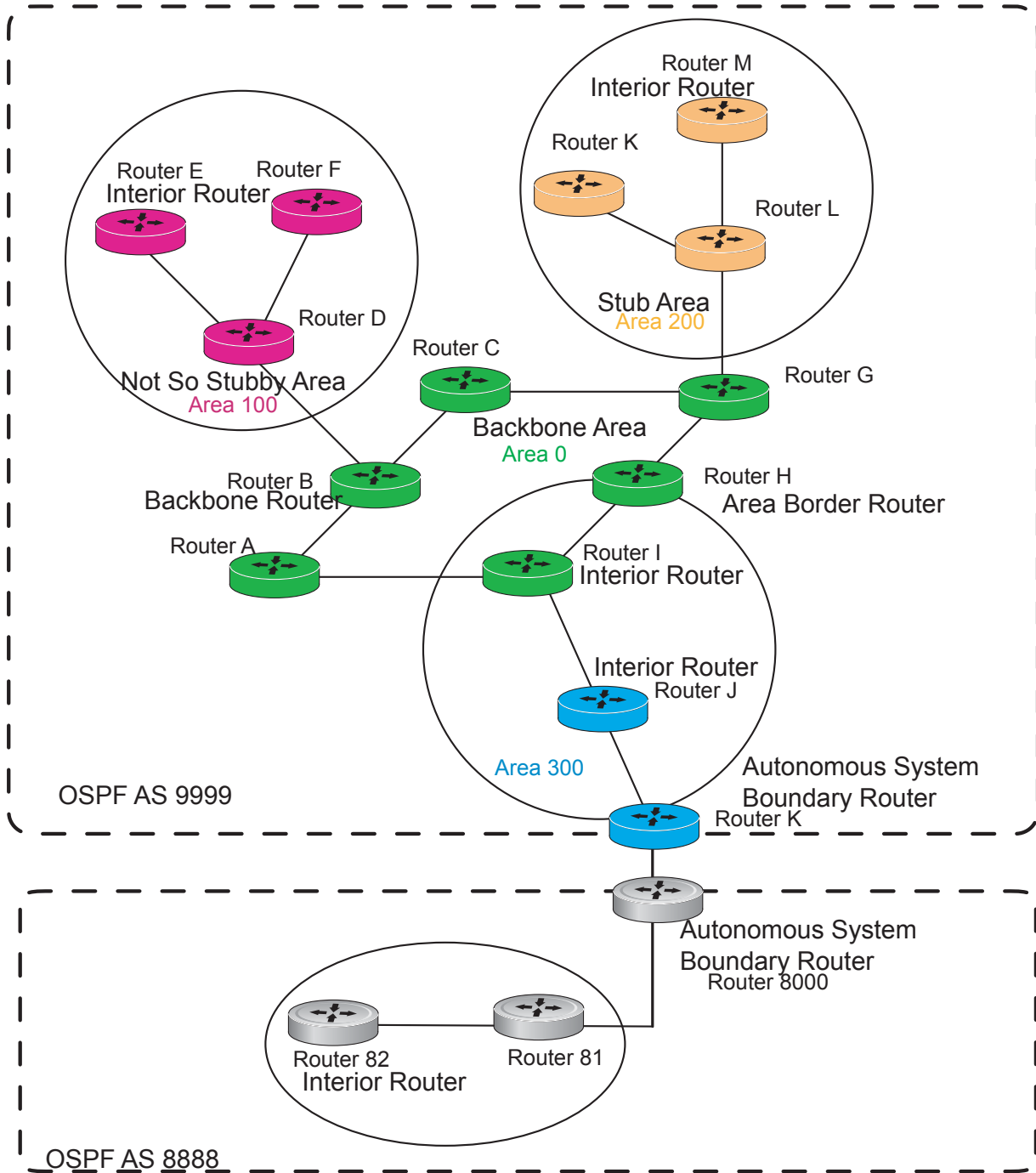

Backbone Router (BR)

A Backbone Router (BR) is part of the OSPF Backbone, Area 0. This includes all Area Border Routers (ABRs). It can also include any routers that connect only to the Backbone and another ABR, but are only part of Area 0, such as Router I in Figure 33-2 above.

Area Border Router (ABR)

Within an AS, an Area Border (ABR) connects one or more areas to the Backbone. The ABR keeps a copy of the link-state database for every area it connects to, so it may keep multiple copies of the link state database. An Area Border Router (ABR) takes information it has learned on one of its attached areas and can summarize it before sending it out on other areas it is connected to.

An ABR can connect to many areas in an AS, and is considered a member of each area it connects to.

Autonomous System Border Router (ASBR)

The Autonomous System Border Area Router (ASBR) connects to more than one AS, and exchanges information with the routers in other ASs. Generally the ASBR connects to a non-Interior Gate Protocol (IGP) such as BGP or uses static routes.

Internal Router (IR)

The Internal Router (IR) has adjacencies with ONLY routers in the same area, as Router E, M and I are shown in [Figure 33-2](#).

Designated and Backup Designated Routers

OSPF elects a Designated Router and a Backup Designated router. Among other things, the designated router is responsible for generating LSAs for the entire multiaccess network. Designated routers allow a reduction in network traffic and in the size of the topological database.

- The Designated Router (DR) maintains a complete topology table of the network and sends the updates to the other routers via multicast. All routers in an area form a slave/master relationship with the DR. Every time a router sends an update, it sends it to the Designated Router (DR) and Backup Designated Router (BDR). The DR sends the update out to all other routers in the area.
- The Backup Designated Router (BDR) is the router that takes over if the DR fails.

Each router exchanges information with the DR and BDR. The DR and BDR relay the information to the other routers. On broadcast network segments the number of OSPF packets is further reduced by the DR and BDR sending such OSPF updates to a multicast IP address that all OSPF routers on the network segment are listening on.

These router designations are not the same as the router IDs discussed earlier. The Designated and Backup Designated Routers are configurable in FTOS. If no DR or BDR is defined in FTOS, the system assigns them. OSPF looks at the priority of the routers on the segment to determine which routers are the DR and BDR. The router with the highest priority is elected the DR. If there is a tie, then the router with the higher Router ID takes precedence. After the DR is elected, the BDR is elected the same way. A router with a router priority set to zero is cannot become the DR or BDR.

Link-State Advertisements (LSAs)

A Link-State Advertisement (LSA) communicates the router's local routing topology to all other local routers in the same area.

The LSA types supported by Dell Force10 are defined as follows:

- Type 1 - Router LSA
 - The router lists links to other routers or networks in the same area. Type 1 LSAs are flooded across their own area only. The Link-State ID of the Type 1 LSA is the originating router ID.
- Type 2 - Network LSA
 - The Designated Router (DR) in an area lists which routers are joined together within the area. Type 2 LSAs are flooded across their own area only. The Link-State ID of the Type 2 LSA is the IP interface address of the DR.
- Type 3 - Summary LSA (OSPFv2)
 - An Area Border Router (ABR) takes information it has learned on one of its attached areas and can summarize it before sending it out on other areas it is connected to. The Link-State ID of the Type 3 LSA is the destination network number.
- Type 4 - AS Border Router Summary LSA (OSPFv2)
 - In some cases, Type 5 External LSAs are flooded to areas where the detailed next-hop information may not be available. An Area Border Router will (ABR) flood the information for the router (i.e. the Autonomous System Border Router (ASBR) where the Type 5 advertisement originated. The Link-State ID for Type 4 LSAs is the router ID of the described ASBR.
- Type 5 - External LSA
 - These LSAs contain information imported into OSPF from other routing processes. They are flooded to all areas, except stub areas. The Link-State ID of the Type 5 LSA is the external network number.
- Type 7
 - Routers in a Not-So-Stubby-Area (NSSA) do not receive external LSAs from Area Border Routers (ABRs), but are allowed to send external routing information for redistribution. They use Type 7 LSAs to tell the ABRs about these external routes, which the Area Border Router then translates to Type 5 external LSAs and floods as normal to the rest of the OSPF network.
- Type 9 - Link Local LSA (OSPFv2)
 - For OSPFv2, this is a link-local “opaque” LSA as defined by RFC2370.

For all LSA types, there are 20-byte LSA headers. One of the fields of the LSA header is the Link-State ID.

Each router link is defined as one of four types: type 1, 2, 3, or 4. The LSA includes a link ID field that identifies, by the network number and mask, the object this link connects to.

Depending on the type, the link ID has different meanings.

- 1: point-to-point connection to another router neighboring router
- 2: connection to a transit network IP address of Designated Router

- 3: connection to a stub network IP network/subnet number
- 4: virtual link neighboring router ID

LSA throttling

LSA throttling provides configurable interval timers to improve OSPF convergence times. The default OSPF static timers (5 seconds for transmission, 1 second for acceptance) ensure sufficient time for sending and resending LSAs and for system acceptance of arriving LSAs. However, some networks may require reduced intervals for LSA transmission and acceptance. The throttling timers allow for this improved convergence times.

The LSA throttling timers are configured in milliseconds, with the interval time increasing exponentially until a maximum time has been reached. If the maximum time is reached, the system, the system continues to transmit at the max-interval until twice the max-interval time has passed. At that point, the system reverts to the start-interval timer and the cycle begins again.

When the LSA throttle timers are configured, syslog messages appear, indicating the interval times.

Message 1 SYSLOG message for LSA transmit timer (45000 msec in this example)

```
Mar 15 09:46:00: %STKUNIT0-M:CP %OSPF-4-LSA_BACKOFF: OSPF Process 10,Router lsa id 2.2.2.2 router-id 2.2.2.2 is backed off to Transmit after 45000ms
```

Message 2 SYSLOG message for LSA arrival timer (1000 msec in this example)

```
Mar 15 09:46:06: %STKUNIT0-M:CP %OSPF-4-LSA_BACKOFF: OSPF Process 10,Router lsa id 3.3.3.3 rtrid 3.3.3.3 received before 1000ms time
```

Virtual Links

In the case in which an area cannot be directly connected to Area 0, you must configure a virtual link between that area and Area 0. The two endpoints of a virtual link are ABRs, and the virtual link must be configured in both routers. The common non-backbone area to which the two routers belong is called a transit area. A virtual link specifies the transit area and the router ID of the other virtual endpoint (the other ABR).

A Virtual Link cannot be configured through a Stub Area or NSSA.

Router Priority and Cost

Router priority and cost is the method the system uses to “rate” the routers. For example, if not assigned, the system will select the router with the highest priority as the DR. The second highest priority is the BDR.

Priority is a numbered rating 0-255. The higher the number, the higher the priority.

Cost is a numbered rating 1-65535. The higher the number, the greater the cost. The cost assigned reflects the cost should the router fail. When a router fails and the cost is assessed, a new priority number results.

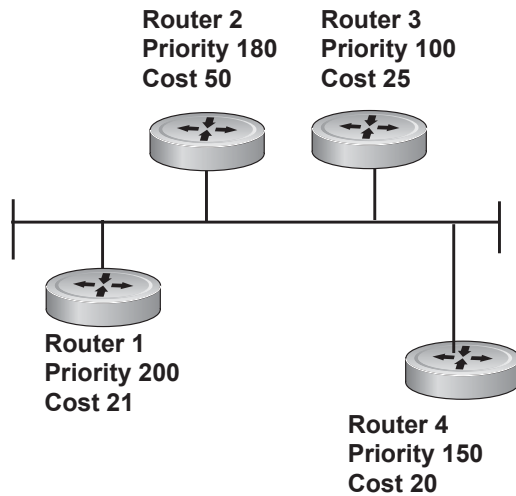
Figure 33-3. Priority and Costs Example

**Router 1 selected by the system as DR.
Router 2 selected by the system as BDR.**

If R1 fails, the system subtracts 21 from R1's priority number. R1's new priority is 179.

R2 as both the selected BDR and the now-highest priority, becomes the DR.

If R3 fails, the system subtracts 50 from its priority. R2's new priority is 130.

R4 is now the highest priority and becomes the DR.

Implementing OSPF with FTOS

FTOS supports up to 10,000 OSPF routes. Within that 10,000 up to 8,000 routes can be designated as external and up to 2,000 designated as inter/intra area routes.

FTOS version 7.8.1.0 and later support multiple OSPF processes (OSPF MP). The Z-Series supports up to 3 OSPF processes simultaneously. The S-Series supports up to 16 processes simultaneously.

FTOS supports Stub areas, Totally Stub (No Summary) and Not So Stubby Areas (NSSAs) and supports the following LSAs, as discussed earlier in this document.

- Router (type 1)
- Network (type 2)
- Network Summary (type 3)
- AS Boundary (type 4)
- AS External (type 5)

- NSSA External (type 7)
- Opaque Link-local (type 9)

Fast Convergence (OSPFv2, IPv4 only)

Fast Convergence allows you to define the speeds at which LSAs are originated and accepted, and reduce OSPFv2 end-to-end convergence time. FTOS enables you to accept and originate LSAs as soon as they are available to speed up route information propagation.

Note that the faster the convergence, the more frequent the route calculations and updates. This will impact CPU utilization and may impact adjacency stability in larger topologies.

Multi-Process OSPF (OSPFv2, IPv4 only)

Multi-Process OSPF is supported on platforms **C**, **E**, and **S** with FTOS version 7.8.1.0 and later, and is supported on OSPFv2 with IPv4 only.

Multi-Process OSPF allows multiple OSPFv2 processes on a single router. Multiple OSPFv2 processes allow for isolating routing domains, supporting multiple route policies and priorities in different domains, and creating smaller domains for easier management.

- The E-Series supports up to 28 OSPFv2 processes.
- The C-Series supports up to 6 OSPFv2 processes.
- The S50 and S25 support up to 4 OSPFv2 processes.
- The S55, S60, S4810, and S4820T support up to 16 OSPFv2 processes.
- The Z9000 supports up to 16 OSPFv2 processes.

Each OSPFv2 process has a unique process ID and must have an associated Router ID. There must be an equal number of interfaces must be in Layer-3 mode for the number of processes created. For example, if 5 OSPFv2 processes are created on a system, there must be at least 5 interfaces assigned in Layer 3 mode.

Each OSPFv2 process is independent. If one process loses adjacency, the other processes continue to function/

Processing SNMP and Sending SNMP Traps

Though there are may be several OSPFv2 processes, only one process can process SNMP requests and send SNMP traps. The `mib-binding` command identifies one of the OSPFv2 processes as the process responsible for SNMP management. If the `mib-binding` command is not specified, the first OSPFv2 process created manages the SNMP processes and traps.

RFC-2328 Compliant OSPF Flooding

In OSPF, flooding is the most resource-consuming task. The flooding algorithm described in RFC 2328 requires that OSPF flood LSAs on all interfaces, as governed by LSA's flooding scope. (Refer to Section 13 of the RFC.) When multiple direct links connect two routers, the RFC 2328 flooding algorithm generates significant redundant information across all links.

By default, FTOS implements an enhanced flooding procedure which dynamically and intelligently detects when to optimize flooding. Wherever possible, the OSPF task attempts to reduce flooding overhead by selectively flooding on a subset of the interfaces between two routers.

If RFC 2328 flooding behavior is required, enable it by using the command `flood-2328` in `ROUTER OSPF` mode. When enabled, this command configures FTOS to flood LSAs on all interfaces.

Confirm RFC 2328 flooding behavior by using the command `debug ip ospf packet` and look for output similar to the following:

Figure 33-4. Enabling RFC-2328 Compliant OSPF Flooding

```
00:10:41 : OSPF(1000:00):
Rcv. v:2 t:5(LSAck) 1:64 Acks 2 rid:2.2.2.2 Printed only for ACK packets
    aid:1500 chk:0xdbee aut:0 auk: keyid:0 from:Vl 1000
        LSType:Type-5 AS External id:160.1.1.0 adv:6.1.0.0 seq:0x8000000c
        LSType:Type-5 AS External id:160.1.2.0 adv:6.1.0.0 seq:0x8000000c
00:10:41 : OSPF(1000:00):
Rcv. v:2 t:5(LSAck) 1:64 Acks 2 rid:2.2.2.2
    aid:1500 chk:0xdbee aut:0 auk: keyid:0 from:Vl 100
        LSType:Type-5 AS External id:160.1.1.0 adv:6.1.0.0 seq:0x8000000c
        LSType:Type-5 AS External id:160.1.2.0 adv:6.1.0.0 seq:0x8000000c
00:10:41 : OSPF(1000:00):
Rcv. v:2 t:4(LSUpd) 1:100 rid:6.1.0.0 No change in update packets
    aid:0 chk:0xccbd aut:0 auk: keyid:0 from:Gi 10/21
    Number of LSA:2
    LSType:Type-5 AS External(5) Age:1 Seq:0x8000000c id:170.1.1.0 Adv:6.1.0.0
        Netmask:255.255.255.0 fwd:0.0.0.0 E2, tos:0 metric:0
    LSType:Type-5 AS External(5) Age:1 Seq:0x8000000c id:170.1.2.0 Adv:6.1.0.0
        Netmask:255.255.255.0 fwd:0.0.0.0 E2, tos:0 metric:0
```

In FTOS Version, 7.5.1.0 use `show ip ospf` to confirm that RFC-2328 compliant OSPF flooding is enabled, as shown below.

Figure 33-5. Enabling RFC-2328 Compliant OSPF Flooding

```
FTOS#show ip ospf
Routing Process ospf 1 with ID 2.2.2.2
Supports only single TOS (TOS0) routes
It is an Autonomous System Boundary Router
It is Flooding according to RFC 2328
SPF schedule delay 5 secs, Hold time between two SPF's 10 secs
Number of area in this router is 1, normal 0 stub 0 nssa 1
--More--
```

OSPF ACK Packing

The OSPF ACK Packing feature bundles multiple LS acknowledgements in a single packet, significantly reducing the number of ACK packets transmitted when the number of LSAs increases. This feature also enhances network utilization and reduces the number of small ACK packets sent to a neighboring router. OSPF ACK packing is enabled by default, and non-configurable.

OSPF Adjacency with Cisco Routers

To establish an OSPF adjacency between Dell Force10 and Cisco routers, the hello interval and dead interval must be the same on both routers. In FTOS the OSPF dead interval value is, by default, set to 40 seconds, and is independent of the OSPF hello interval. Configuring a hello interval does not change the dead interval in FTOS. In contrast, the OSPF dead interval on a Cisco router is, by default, four times as long as the hello interval. Changing the hello interval on the Cisco router automatically changes the dead interval as well.

To ensure equal intervals between the routers, manually set the dead interval of the Dell Force10 router to match the Cisco configuration. Use the command “**ip ospf dead-interval <x>**” in interface mode:

Figure 33-6. Command Example: ip ospf intervals

```
FTOS(conf)#int gi 2/2
FTOS(conf-if-gi-2/2)#ip ospf hello-interval 20
FTOS(conf-if-gi-2/2)#ip ospf dead-interval 80
FTOS(conf-if-gi-2/2)#
```

← Dead Interval Set at 4x Hello Interval

Figure 33-7. OSPF Configuration with intervals set

```
FTOS (conf-if-gi-2/2)#ip ospf dead-interval 20
FTOS (conf-if-gi-2/2)#do show ip os int gi1/3
GigabitEthernet 2/2 is up, line protocol is up
Internet Address 20.0.0.1/24, Area 0
Process ID 10, Router ID 1.1.1.2, Network Type BROADCAST, Cost: 1
Transmit Delay is 1 sec, State DR, Priority 1
Designated Router (ID) 1.1.1.2, Interface address 30.0.0.1
Backup Designated Router (ID) 1.1.1.1, Interface address 30.0.0.2
Timer intervals configured, Hello 20, Dead 80, Wait 20, Retransmit 5
Hello due in 00:00:04
Neighbor Count is 1, Adjacent neighbor count is 1
Adjacent with neighbor 1.1.1.1 (Backup Designated Router)
FTOS (conf-if-gi-2/2)#
```

← Dead Interval Set at 4x Hello Interval

For more information regarding this functionality or for assistance, go to www.force10networks.com/support.

Configuration Information

The interfaces must be in Layer-3 mode (assigned an IP address) and enabled so that they can send and receive traffic. The OSPF process must know about these interfaces. To make the OSPF process aware of these interfaces, they must be assigned to OSPF areas.

OSPF must be configured GLOBALLY on the system in CONFIGURATION mode.

OSPF features and functions are assigned to each router using the CONFIG-INTERFACE commands for each interface.



Note: By default, OSPF is disabled

Configuration Task List for OSPFv2 (OSPF for IPv4)

Open Shortest Path First version 2 (OSPF for IPv4) is supported on platforms **C e S**

1. Configure a physical interface. Assign an IP address, physical or loopback, to the interface to enable Layer 3 routing.
2. Enable OSPF globally. Assign network area and neighbors.
3. Add interfaces or configure other attributes.

The following configuration steps include two mandatory steps and several optional ones:

- Enable OSPFv2 (mandatory)
- Enable Multi-Process OSPF
- Assign an OSPFv2 area (mandatory)
- Enable OSPFv2 on interfaces
- Configure stub areas
- Configure LSA throttling timers
- Enable passive interfaces
- Enable fast-convergence
- Change OSPFv2 parameters on interfaces
- Enable OSPFv2 authentication
- Configure virtual links
- Redistribute routes
- Troubleshooting OSPFv2

For a complete listing of all commands related to OSPFv2, refer to the OSPF section in the *FTOS Command Line Interface* document.

Enable OSPFv2

Assign an IP address to an interface (physical or Loopback) to enable Layer 3 routing. By default OSPF, like all routing protocols, is disabled.

You *must* configure at least one interface for Layer 3 before enabling OSPFv2 globally.

If implementing, Multi-Process OSPF, you must create an equal number of Layer 3 enabled interfaces and OSPF Process IDs. For example, if you create 4 OSPFv2 process IDs, you must have 4 interfaces with Layer 3 enabled.

Use these commands on one of the interfaces to enable OSPFv2 routing.

| Step | Command Syntax | Command Mode | Usage |
|------|--|------------------|---|
| 1 | <code>ip address <i>ip-address mask</i></code> | CONFIG-INTERFACE | Assign an IP address to an interface. Format: A.B.C.D/M If using a Loopback interface, refer to Loopback Interfaces on page 446 . |
| 2 | <code>no shutdown</code> | CONFIG-INTERFACE | Enable the interface. |

Return to CONFIGURATION mode to enable the OSPF process. The OSPF Process ID is the identifying number assigned to the OSPF process, and the Router ID is the IP address associated with the OSPF process. .

| Command Syntax | Command Mode | Usage |
|--|---------------|---|
| <code>router ospf <i>process-id</i> [<i>vrf {vrf name}</i>]</code> | CONFIGURATION | Enable the OSPFv2 process globally. Range: 0-65535 <i>vrf name</i> : Enter the VRF key word and instance name to tie the OSPF instance to the VRF. All network commands under this OSPF instance are subsequently tied to the VRF instance. |

Once the OSPF process and the VRF are tied together, the OSPF Process ID cannot be used again in the system.

If you try to enter an OSPF Process ID, or if you try to enable more OSPF processes than available Layer 3 interfaces, prior to assigning an IP address to an interface and setting the no shutdown command, you will see the following message.

Message 3

```
C300(conf)#router ospf 1
% Error: No router ID available.
```

In CONFIGURATION ROUTER OSPF mode, assign the Router ID. The Router ID is not required to be the router's IP address. Dell Force10 recommends using the IP address as the Router ID for easier management and troubleshooting.

| Command Syntax | Command Mode | Usage |
|--|---------------------------|---|
| <code>router-id <i>ip address</i></code> | CONFIG-ROUTER-O SPF-id | Assign the Router ID for the OSPFv2 process. IP Address: A.B.C.D |

Use the `no router ospf process-id` command syntax in the CONFIGURATION mode to disable OSPF.

Use the `clear ip ospf process-id` command syntax in EXEC Privilege mode to reset the OSPFv2 process.

Use the `show ip ospf process-id` command in EXEC mode (Figure 408) to view the current OSPFv2 status.

Figure 33-8. Command Example: show ip ospf process-id

```
FTOS#show ip ospf 55555
Routing Process ospf 55555 with ID 10.10.10.10
Supports only single TOS (TOS0) routes
SPF schedule delay 5 secs, Hold time between two SPFs 10 secs
Number of area in this router is 0, normal 0 stub 0 nssa 0
FTOS#
```

Enable Multi-Process OSPF

Multi-Process OSPF allows multiple OSPFv2 processes on a single router.

Follow the same steps as above, when configuring a single OSPF process. Repeat them as often as necessary for the desired number of processes. Once the process is created, all other configurations apply as usual,

| Step | Command Syntax | Command Mode | Usage |
|------|---|------------------|---|
| 1 | <code>ip address ip-address mask</code> | CONFIG-INTERFACE | Assign an IP address to an interface. Format: A.B.C.D/M If using a Loopback interface, refer to Loopback Interfaces on page 446 . |
| 2 | <code>no shutdown</code> | CONFIG-INTERFACE | Enable the interface. |

Return to CONFIGURATION mode to enable the OSPF process. The OSPF Process ID is the identifying number assigned to the OSPF process, and the Router ID is the IP address associated with the OSPF process. .

| Command Syntax | Command Mode | Usage |
|--|---------------|---|
| <code>router ospf process-id [vrf {vrf name}]</code> | CONFIGURATION | Enable the OSPFv2 process globally. Range: 0-65535 <i>vrf name</i> : Enter the VRF key word and instance name to tie the OSPF instance to the VRF. All network commands under this OSPF instance are subsequently tied to the VRF instance. |

Once the OSPF process and the VRF are tied together, the OSPF Process ID cannot be used again in the system.

If you try to enable more OSPF processes than available Layer 3 interfaces you will see the following message.

Message 4

```
C300(conf)#router ospf 1
% Error: No router ID available.
```

In CONFIGURATION ROUTER OSPF mode, assign the Router ID. The Router ID is not required to be the router's IP address. Dell Force10 recommends using the IP address as the Router ID for easier management and troubleshooting.

| Command Syntax | Command Mode | Usage |
|-----------------------------------|-----------------------|---|
| <code>router-id ip address</code> | CONFIG-ROUTER-OSPF-id | Assign the Router ID for the OSPFv2 process. IP Address: A.B.C.D |

Use the `no router ospf process-id` command syntax in the CONFIGURATION mode to disable OSPF.

Use the `clear ip ospf process-id` command syntax in EXEC Privilege mode to reset the OSPFv2 process.

Assign an OSPFv2 area

After OSPFv2 is enabled, assign the interface to an OSPF area. Set up OSPF Areas and enable OSPFv2 on an interface with the `network` command.

You must have at least one AS area: Area 0. This is the Backbone Area. If your OSPF network contains more than one area, you must also configure a backbone area (Area ID 0.0.0.0). Any area besides Area 0 can have any number ID assigned to it.

The OSPFv2 process evaluates the network commands in the order they are configured. Assign the network address that is most explicit first to include all subnets of that address. For example, if you assign the network address 10.0.0.0 /8, you cannot assign the network address 10.1.0.0 /16 since it is already included in the first network address.

When configuring the `network` command, you must configure a network address and mask that is a superset of the IP subnet configured on the Layer-3 interface to be used for OSPFv2.

Use this command in CONFIGURATION ROUTER OSPF mode to set up each neighbor and OSPF area. The Area can be assigned by a number or with an IP interface address.

| Command Syntax | Command Mode | Usage |
|---|-----------------------|---|
| <code>network ip-address mask area area-id</code> | CONFIG-ROUTER-OSPF-id | Enable OSPFv2 on an interface and assign an network address range to a specific OSPF area. IP Address Format: A.B.C.D/M Area ID Range: 0-65535 or A.B.C.D/M |

Enable OSPFv2 on interfaces

Each interface must have OSPFv2 enabled on it. It must be configured for Layer 3 protocol, and not be shutdown. OSPFv2 can also be assigned to a loopback interface as a virtual interface.

OSPF functions and features, such as MD5 Authentication, Grace Period, Authentication Wait Time, etc, are assigned on a per interface basis.



Note: If using features like MD5 Authentication, ensure all the neighboring routers are also configured for MD5.

Figure 33-9 presents an example of assigning an IP address to an interface and then assigning an OSPFv2 area that includes that Layer-3 interface's IP address.

Figure 33-9. Configuring an OSPF Area Example

```

FTOS#(conf)#int gi 4/44
FTOS (conf-if-gi-4/44)#ip address 10.10.10.10/24
FTOS (conf-if-gi-4/44)#no shutdown
FTOS (conf-if-gi-4/44)#ex
FTOS (conf)#router ospf 1
FTOS (conf-router_ospf-1)#network 1.2.3.4/24 area 0
FTOS (conf-router_ospf-1)#network 10.10.10.10/24 area 1
FTOS (conf-router_ospf-1)#network 20.20.20.20/24 area 2
FTOS (conf-router_ospf-1)#
FTOS#
  
```

← Assign Layer-3 interface with IP Address and no shutdown

← Assign interface's IP Address to an Area

Dell Force10 recommends that the OSPFv2 Router ID be the interface IP addresses for easier management and troubleshooting.

Use the show config command in CONFIGURATION ROUTER OSPF mode to view the configuration.

OSPF, by default, sends hello packets out to all physical interfaces assigned an IP address that are a subset of a network on which OSPF is enabled. Use the show ip ospf interface command (Figure 410) to view the interfaces currently active and the areas assigned to the interfaces.

Figure 33-10. Command Example: show ip ospf process-id interface

```
FTOS>show ip ospf 1 interface

GigabitEthernet 12/17 is up, line protocol is up
  Internet Address 10.2.2.1/24, Area 0.0.0.0
  Process ID 1, Router ID 11.1.2.1, Network Type BROADCAST, Cost: 1
  Transmit Delay is 1 sec, State DR, Priority 1
  Designated Router (ID) 11.1.2.1, Interface address 10.2.2.1
  Backup Designated Router (ID) 0.0.0.0, Interface address 0.0.0.0
  Timer intervals configured, Hello 10, Dead 40, Wait 40, Retransmit 5
    Hello due in 00:00:04
  Neighbor Count is 0, Adjacent neighbor count is 0

GigabitEthernet 12/21 is up, line protocol is up
  Internet Address 10.2.3.1/24, Area 0.0.0.0
  Process ID 1, Router ID 11.1.2.1, Network Type BROADCAST, Cost: 1
  Transmit Delay is 1 sec, State BDR, Priority 1
  Designated Router (ID) 13.1.1.1, Interface address 10.2.3.2
  Backup Designated Router (ID) 11.1.2.1, Interface address 10.2.3.1
  Timer intervals configured, Hello 10, Dead 40, Wait 40, Retransmit 5
    Hello due in 00:00:05
  Neighbor Count is 1, Adjacent neighbor count is 1
    Adjacent with neighbor 13.1.1.1 (Designated Router)
FTOS>
```

Loopback interfaces also assist in the OSPF process. OSPF will pick the highest interface address as the router-id and a loopback interface address has a higher precedence than other interface addresses.

Figure 33-11 gives an example of the show ip ospf process-id interface command with a Loopback interface.

Figure 33-11. Command Example: show ip ospf process-id interface

```
FTOS#show ip ospf 1 int

GigabitEthernet 13/23 is up, line protocol is up
  Internet Address 10.168.0.1/24, Area 0.0.0.1
  Process ID 1, Router ID 10.168.253.2, Network Type BROADCAST, Cost: 1
  Transmit Delay is 1 sec, State DROTHER, Priority 1
  Designated Router (ID) 10.168.253.5, Interface address 10.168.0.4
  Backup Designated Router (ID) 192.168.253.3, Interface address 10.168.0.2
  Timer intervals configured, Hello 10, Dead 40, Wait 40, Retransmit 5
    Hello due in 00:00:08
  Neighbor Count is 3, Adjacent neighbor count is 2
    Adjacent with neighbor 10.168.253.5 (Designated Router)
    Adjacent with neighbor 10.168.253.3 (Backup Designated Router)

Loopback 0 is up, line protocol is up
  Internet Address 10.168.253.2/32, Area 0.0.0.1
  Process ID 1, Router ID 10.168.253.2, Network Type LOOPBACK, Cost: 1
  Loopback interface is treated as a stub Host.
FTOS#
```

Configure stub areas

OSPF supports different types of LSAs to help reduce the amount of router processing within the areas. Type 5 LSAs are not flooded into stub areas; the Area Border Router (ABR) advertises a default route into the stub area to which it is attached. Stub area routers use the default route to reach external destinations

To ensure connectivity in your OSPFv2 network, never configure the backbone area as a stub area.

Use these commands in the following sequence, starting in EXEC Privilege mode to configure a stub area.

| Step | Command Syntax | Command Mode | Usage |
|------|---|---------------------------|--|
| 1 | <code>show ip ospf <i>process-id</i> [<i>vrf vrf name</i>] database database-summary</code> | EXEC Privilege | Review all areas after they were configured to determine which areas are NOT receiving type 5 LSAs. <i>vrf name</i> : Show only the OSPF information tied to the VRF process. |
| 2 | <code>configure</code> | EXEC Privilege | Enter the CONFIGURATION mode. |
| 3 | <code>router ospf <i>process-id</i> [<i>vrf {vrf name}</i>]</code> | CONFIGURATION | Enter the ROUTER OSPF mode. Process ID is the ID assigned when configuring OSPFv2 globally (page 58). <i>vrf name</i> : Enter the VRF key word and instance name to tie the OSPF instance to the VRF. All network commands under this OSPF instance are subsequently tied to the VRF instance. |
| 4 | <code>area <i>area-id</i> stub [<i>no-summary</i>]</code> | CONFIG-ROUTER-O SPF-id | Configure the area as a stub area. Use the no-summary keywords to prevent transmission in to the area of summary ASBR LSAs. Area ID is the number or IP address assigned when creating the Area (page 60). |

Use the `show ip ospf database process-id database-summary` command syntax (Figure 413) in the EXEC Privilege mode To view which LSAs are transmitted.

Figure 33-12. Command Example: show ip ospf *process-id* database database-summary

```
FTOS#show ip ospf 34 database database-summary

          OSPF Router with ID (10.1.1.2.100) (Process ID 34)

Area ID      Router  Network S-Net   S-ASBR  Type-7  Subtotal
2.2.2.2      1       0       0       0       0       1
3.3.3.3      1       0       0       0       0       1
FTOS#
```

To view information on areas, use the `show ip ospf process-id` command in the EXEC Privilege mode.

Configure LSA throttling timers

Configured LSA timers replace the standard transmit and acceptance times for LSAs. The LSA throttling timers are configured in milliseconds, with the interval time increasing exponentially until a maximum time has been reached. If the maximum time is reached, the system continues to transmit at the max-interval. If the system is stable for twice the maximum interval time, the system reverts to the start-interval timer and the cycle begins again.

| Command Syntax | Command Mode | Usage |
|--|---------------------------|--|
| <code>timers throttle lsa all</code> {start-interval hold-interval max-interval} | CONFIG-ROUTER- OSPF-id | Specify the interval times for all LSA transmissions <ul style="list-style-type: none">start-interval: Set the minimum interval between initial sending and resending the same LSA. Range: 0-600,000 millisecondshold-interval: Set the next interval to send the same LSA. This is the time between sending the same LSA after the start-interval has been attempted. Range: 1-600,000 millisecondsmax-interval: Set the maximum amount of time the system waits before sending the LSA. Range: 1-600,000 milliseconds |
| <code>timers throttle lsa arrival</code> <i>arrival-time</i> | CONFIG-ROUTER- OSPF-id | Specify the interval for LSA acceptance. <ul style="list-style-type: none">arrival-time: Set the interval between receiving the same LSA repeatedly, to allow sufficient time for the system to accept the LSA. Range: 0-600,000 milliseconds |

Enable passive interfaces

A passive interface is one that does not send or receive routing information. Enabling passive interface suppresses routing updates on an interface. Although the passive interface will neither send nor receive routing updates, the network on that interface will still be included in OSPF updates sent via other interfaces.

Use the following command in the ROUTER OSPF mode to suppress the interface's participation on an OSPF interface. This command stops the router from sending updates on that interface.

| Command Syntax | Command Mode | Usage |
|--|-----------------------|---|
| <code>passive-interface {default interface}</code> | CONFIG-ROUTER-OSPF-id | <p>Specify whether all or some of the interfaces will be passive. Default enabled passive interfaces on ALL interfaces in the OSPF process.</p> <p>Entering the physical interface type, slot, and number enable passive interface on only the identified interface.</p> <ul style="list-style-type: none"> For a Gigabit Ethernet interface, enter the keyword <code>GigabitEthernet</code> followed by the slot/port information (e.g. passive-interface gi 2/1). For a port channel, enter the keyword <code>port-channel</code> followed by a number from 1 to 255 for TeraScale and ExaScale, 1 to 32 for EtherScale (e.g. passive-interface po 100). For a SONET interface, enter the keyword <code>sonet</code> followed by the slot/port information (e.g. passive-interface so 2/2). For a 10-Gigabit Ethernet interface, enter the keyword <code>TenGigabitEthernet</code> followed by the slot/port information (e.g. passive-interface ten 2/3). For a VLAN, enter the keyword <code>vlan</code> followed by a number from 1 to 4094 (e.g. passive-interface vlan 2222). For a 40-Gigabit Ethernet interface, enter the keyword fortyGigE followed by the slot/port information. <p>The default keyword sets all interfaces on this OSPF process as passive. The passive interface can be removed from select interfaces using the <code>no passive-interface interface</code> command while passive interface default is configured.</p> |

To enable both receiving and sending routing updates, enter the `no passive-interface interface` command.

When you configure a passive interface, the `show ip ospf process-id interface` command (Figure 413) adds the words "passive interface" to indicate that hello packets are not transmitted on that interface.

Figure 33-13. Command Example: show ip ospf process-id interface

```

FTOS#show ip ospf 34 int

GigabitEthernet 0/0 is up, line protocol is down
  Internet Address 10.1.2.100/24, Area 1.1.1.1
  Process ID 34, Router ID 10.1.2.100, Network Type BROADCAST, Cost: 10
  Transmit Delay is 1 sec, State DOWN, Priority 1
  Designated Router (ID) 10.1.2.100, Interface address 0.0.0.0
  Backup Designated Router (ID) 0.0.0.0, Interface address 0.0.0.0
  Timer intervals configured, Hello 10, Dead 40, Wait 40, Retransmit 5
  Hello due in 13:39:46
  Neighbor Count is 0, Adjacent neighbor count is 0

GigabitEthernet 0/1 is up, line protocol is down
  Internet Address 10.1.3.100/24, Area 2.2.2.2
  Process ID 34, Router ID 10.1.2.100, Network Type BROADCAST, Cost: 10
  Transmit Delay is 1 sec, State DR, Priority 1
  Designated Router (ID) 10.1.2.100, Interface address 10.1.3.100
  Backup Designated Router (ID) 0.0.0.0, Interface address 0.0.0.0
  Timer intervals configured, Hello 10, Dead 40, Wait 40, Retransmit 5
  No Hellos (Passive interface) ← Interface is not running the OSPF protocol.
  Neighbor Count is 0, Adjacent neighbor count is 0

Loopback 45 is up, line protocol is up
  Internet Address 10.1.1.23/24, Area 2.2.2.2
  Process ID 34, Router ID 10.1.2.100, Network Type LOOPBACK, Cost: 1
  Loopback interface is treated as a stub Host.
FTOS#

```

Enable fast-convergence

The fast-convergence CLI sets the minimum origination and arrival LSA parameters to zero (0), allowing rapid route calculation. When fast-convergence is disabled, origination and arrival LSA parameters are set to 5 seconds and 1 second, respectively.

Setting the convergence parameter (1-4) indicates the actual convergence level. Each convergence setting adjusts the LSA parameters to zero, but the fast-convergence parameter setting allows for even finer tuning of the convergence speed. The higher the number, the faster the convergence. Use the following command in the ROUTER OSPF mode to enable or disable fast-convergence.

| Command Syntax | Command Mode | Usage |
|---|-----------------------|--|
| fast-convergence {number} | CONFIG-ROUTER-OSPF-id | Enable OSPF fast-convergence and specify the convergence level. Parameter: 1-4 The higher the number, the faster the convergence. When disabled, the parameter is set at 0 (Figure 33-15). |
|  | | Note: A higher convergence level can result in occasional loss of OSPF adjacency. Generally, convergence level 1 meets most convergence requirements. Higher convergence levels should only be selected following consultation with Dell Force10 technical support. |

Figure 33-14 shows the convergence settings when fast-convergence is enabled and Figure 33-15 shows settings when fast-convergence is disabled. These displays appear with the show ip ospf command.

Figure 33-14. Command Example: show ip ospf process-id (fast-convergence enabled)

```

FTOS(conf-router_ospf-1)#fast-converge 2
FTOS(conf-router_ospf-1)#ex
FTOS(conf)#ex
FTOS#show ip ospf 1
Routing Process ospf 1 with ID 192.168.67.2
Supports only single TOS (TOS0) routes
SPF schedule delay 5 secs, Hold time between two SPFs 10 secs
Convergence Level 2
Min LSA origination 0 secs, Min LSA arrival 0 secs
Number of area in this router is 0, normal 0 stub 0 nssa 0
FTOS#

```

Fast-converge parameter setting

LSA Parameters

Figure 33-15. Command example: show ip ospf process-id (fast-convergence disabled)

```

FTOS#(conf-router_ospf-1)#no fast-converge
FTOS#(conf-router_ospf-1)#ex
FTOS#(conf)#ex
FTOS##show ip ospf 1
Routing Process ospf 1 with ID 192.168.67.2
Supports only single TOS (TOS0) routes
SPF schedule delay 5 secs, Hold time between two SPFs 10 secs
Convergence Level 0
Min LSA origination 5 secs, Min LSA arrival 1 secs
Number of area in this router is 0, normal 0 stub 0 nssa 0
FTOS#

```

Fast-converge parameter setting

LSA Parameters

Change OSPFv2 parameters on interfaces

In FTOS, you can modify the OSPF settings on the interfaces. Some interface parameter values must be consistent across all interfaces to avoid routing errors. For example, you must set the same time interval for the hello packets on all routers in the OSPF network to prevent misconfiguration of OSPF neighbors.

Use any or all of the following commands in CONFIGURATION INTERFACE mode to change OSPFv2 parameters on the interfaces:

| Command Syntax | Command Mode | Usage |
|---|------------------|--|
| <code>ip ospf cost</code> | CONFIG-INTERFACE | Change the cost associated with OSPF traffic on the interface. Cost: 1 to 65535 (default depends on the interface speed). |
| <code>ip ospf dead-interval seconds</code> | CONFIG-INTERFACE | Change the time interval the router waits before declaring a neighbor dead. Configure Seconds range: 1 to 65535 (default is 40 seconds). The dead interval must be four times the hello interval. The dead interval must be the same on all routers in the OSPF network. |
| <code>ip ospf hello-interval seconds</code> | CONFIG-INTERFACE | Change the time interval between hello-packet transmission. Seconds range: from 1 to 65535 (default is 10 seconds). The hello interval must be the same on all routers in the OSPF network. |
| <code>ip ospf message-digest-key keyid md5 key</code> | CONFIG-INTERFACE | Use the MD5 algorithm to produce a message digest or key, which is sent instead of the key. Keyid range: 1 to 255 Key: a character string Be sure to write down or otherwise record the Key. You cannot learn the key once it is configured. You must be careful when changing this key. |
| <code>ip ospf priority number</code> | CONFIG-INTERFACE | Change the priority of the interface, which is used to determine the Designated Router for the OSPF broadcast network. Number range: 0 to 255 (the default is 1). |
| <code>ip ospf retransmit-interval seconds</code> | CONFIG-INTERFACE | Change the retransmission interval between LSAs. Seconds range: from 1 to 65535 (default is 5 seconds). The retransmit interval must be the same on all routers in the OSPF network. |
| <code>ip ospf transmit-delay seconds</code> | CONFIG-INTERFACE | Change the wait period between link state update packets sent out the interface. Seconds range: from 1 to 65535 (default is 1 second). The transmit delay must be the same on all routers in the OSPF network. |

Use the show config command in CONFIGURATION INTERFACE mode (Figure 33-16) to view interface configurations. Use the show ip ospf interface command in EXEC mode to view interface status in the OSPF process.

Figure 33-16. Changing the OSPF Cost Value on an Interface

```

FTOS(conf-if)#ip ospf cost 45
FTOS(conf-if)#show config
!
interface GigabitEthernet 0/0
 ip address 10.1.2.100 255.255.255.0
 no shutdown
 ip ospf cost 45
FTOS(conf-if)#end
FTOS#show ip ospf 34 interface

GigabitEthernet 0/0 is up, line protocol is up
 Internet Address 10.1.2.100/24, Area 2.2.2.2
 Process ID 34, Router ID 10.1.2.100, Network Type BROADCAST, Cost: 45
 Transmit Delay is 1 sec, State DR, Priority 1
 Designated Router (ID) 10.1.2.100, Interface address 10.1.2.100
 Backup Designated Router (ID) 10.1.2.100, Interface address 0.0.0.0
 Timer intervals configured, Hello 10, Dead 40, Wait 40, Retransmit 5
 Hello due in 00:00:06
 Neighbor Count is 0, Adjacent neighbor count is 0
FTOS#

```

The change is made on the interface and it is reflected in the OSPF configuration

Enable OSPFv2 authentication

Use the following commands in CONFIGURATION INTERFACE mode to enable or change various OSPF authentication parameters:

| Command Syntax | Command Mode | Usage |
|---|------------------|--|
| <code>ip ospf authentication-key <i>key</i></code> | CONFIG-INTERFACE | Set clear text authentication scheme on the interface. Configure a <i>key</i> that is a text string no longer than eight characters. All neighboring routers must share the same password to exchange OSPF information. |
| <code>ip ospf auth-change-wait-time <i>seconds</i></code> | CONFIG-INTERFACE | Set the authentication change wait time in <i>seconds</i> between 0 and 300 for the interface. This is the amount of time OSPF has available to change its interface authentication type. During the <i>auth-change-wait-time</i> , OSPF sends out packets with both the new and old authentication schemes. This transmission stops when the period ends. The default is 0 seconds. |

Configure virtual links

Areas within OSPF must be connected to the backbone area (Area ID 0.0.0.0). If an OSPF area does not have a direct connection to the backbone, at least one virtual link is required. Virtual links must be configured on an ABR connected to the backbone.

- `hello-interval`: help packet
- `retransmit-interval`: LSA retransmit interval

- transmit-delay: LSA transmission delay
- dead-interval: dead router detection time
- authentication-key: authentication key
- message-digest-key: MD5 authentication key

Use the following command in CONFIGURATION ROUTER OSPF mode to configure virtual links.

| Command Syntax | Command Mode | Usage |
|---|-----------------------|--|
| <code>area <i>area-id</i> virtual-link <i>router-id</i> [hello-interval <i>seconds</i> retransmit-interval <i>seconds</i> transmit-delay <i>seconds</i> dead-interval <i>seconds</i> authentication-key <i>key</i> message-digest-key <i>keyid</i> md5 <i>key</i>]</code> | CONFIG-ROUTER-OSPF-id | <p>Configure the optional parameters of a virtual link:</p> <ul style="list-style-type: none"> • Area ID: assigned earlier (0-65535 or A.B.C.D) • Router ID: IP address associated with the virtual link neighbor • Hello Interval Seconds: 1-8192 (default 10) • Retransmit Interval Seconds: 1-3600 (default 5) • Transmit Delay Seconds: 1-3600 (default 1) • Dead Interval Seconds: 1-8192 (default 40) • Authentication Key: 8 characters • Message Digest Key: 1-255 • MD5 Key: 16 characters <p>Only the Area ID and Router ID require configuration to create a virtual link. If no other parameter is entered, the defaults are used. Use EITHER the Authentication Key or the Message Digest (MD5) key.</p> |

Use the `show ip ospf process-id virtual-links` command (Figure 33-17) in the EXEC mode to view the virtual link.

Figure 33-17. Command Example: show ip ospf *process-id* virtual-links

```

FTOS#show ip ospf 1 virtual-links

Virtual Link to router 192.168.253.5 is up
  Run as demand circuit
  Transit area 0.0.0.1, via interface GigabitEthernet 13/16, Cost of using 2
  Transmit Delay is 1 sec, State POINT_TO_POINT,
    Timer intervals configured, Hello 10, Dead 40, Wait 40, Retransmit 5
    Hello due in 00:00:02
FTOS#

```

Filter routes

To filter routes, use prefix lists. OSPF applies prefix lists to incoming or outgoing routes. Incoming routes must meet the conditions of the prefix lists, and if they do not, OSPF does not add the route to the routing table. Configure the prefix list in CONFIGURATION PREFIX LIST mode prior to assigning it to the OSPF process.

| Command Syntax | Command Mode | Usage |
|--|---------------------|---|
| <code>ip prefix-list <i>prefix-name</i></code> | CONFIGURATION | Create a prefix list and assign it a unique name. You are in PREFIX LIST mode. |
| <code>seq <i>sequence-number</i> {deny permit} <i>ip-prefix</i> [ge <i>min-prefix-length</i>] [le <i>max-prefix-length</i>]</code> | CONFIG- PREFIX LIST | Create a prefix list with a sequence number and a deny or permit action. The optional parameters are: ge <i>min-prefix-length</i> : is the minimum prefix length to be matched (0 to 32). le <i>max-prefix-length</i> : is the maximum prefix length to be matched (0 to 32). |

For configuration information on prefix lists, refer to *IP Access Control Lists, Prefix Lists, and Route-maps* chapter in the *FTOS Configuration Guide*.

Use the following commands in CONFIGURATION-ROUTER OSPF mode to apply prefix lists to incoming or outgoing OSPF routes

| Command Syntax | Command Mode | Usage |
|--|-----------------------|--|
| <code>distribute-list <i>prefix-list-name</i> in [<i>interface</i>]</code> | CONFIG-ROUTER-OSPF-id | Apply a configured prefix list to incoming OSPF routes. |
| <code>distribute-list <i>prefix-list-name</i> out [connected isis rip static]</code> | CONFIG-ROUTER-OSPF-id | Assign a configured prefix list to outgoing OSPF routes. |

Redistribute routes

You can add routes from other routing instances or protocols to the OSPF process. With the redistribute command syntax, you can include RIP, static, or directly connected routes in the OSPF process.



Note: Do not route iBGP routes to OSPF unless there are route-maps associated with the OSPF redistribution.

Use the following command in CONFIGURATION- ROUTER-OSPF mode to redistribute routes:

| Command Syntax | Command Mode | Usage |
|---|-----------------------|--|
| <code>redistribute {bgp connected isis rip static} [metric <i>metric-value</i> metric-type <i>type-value</i>] [route-map <i>map-name</i>] [tag <i>tag-value</i>]</code> | CONFIG-ROUTER-OSPF-id | Specify which routes will be redistributed into OSPF process. Configure the following required and optional parameters: <ul style="list-style-type: none">• <code>bgp</code>, <code>connected</code>, <code>isis</code>, <code>rip</code>, or <code>static</code>: enter one of the keyword to redistribute those routes. <code>rip</code> is supported only on E-Series.• <code>metric <i>metric-value</i></code> range: 0 to 4294967295.• <code>metric-type <i>metric-type</i></code>: 1 for OSPF external route type 1 or 2 for OSPF external route type 2.• <code>route-map <i>map-name</i></code>: enter a name of a configured route map.• <code>tag <i>tag-value</i></code> range: 0 to 4294967295. |

To view the current OSPF configuration, use the `show running-config ospf` command in the EXEC mode or the `show config` command in the ROUTER OSPF mode

Figure 33-18. Command Example: show config

```
FTOS (conf-router_ospf) #show config
!
router ospf 34
 network 10.1.2.32 0.0.0.255 area 2.2.2.2
 network 10.1.3.24 0.0.0.255 area 3.3.3.3
 distribute-list dilling in
FTOS (conf-router_ospf) #
```

Troubleshooting OSPFv2

FTOS has several tools to make troubleshooting easier. Be sure to check the following, as these are typical issues that interrupt an OSPFv2 process. Note that this is not a comprehensive list, just some examples of typical troubleshooting checks.

- Has OSPF been enabled globally?
- Is the OSPF process active on the interface?
- Are adjacencies established correctly?
- Are the interfaces configured for Layer 3 correctly?
- Is the router in the correct area type?

- Have the routes been included in the OSPF database?
- Have the OSPF routes been included in the routing table (not just the OSPF database)?

Some useful troubleshooting commands are:

- show interfaces
- show protocols
- debug IP OSPF events and/or packets
- show neighbors
- show virtual links
- show routes

Use the show running-config ospf command to see the state of all the enabled OSPFv2 processes.

| Command Syntax | Command Mode | Usage |
|--------------------------|----------------|---|
| show running-config ospf | EXEC Privilege | View the summary of all OSPF process IDs enables on the router. |

Figure 33-19. Command Example: show running-config ospf

```
FTOS#show run ospf
!
router ospf 3
!
router ospf 4
  router-id 4.4.4.4
  network 4.4.4.0/28 area 1
!
router ospf 5
!
router ospf 6
!
router ospf 7
  mib-binding
!
router ospf 8
!
router ospf 90
  area 2 virtual-link 4.4.4.4
  area 2 virtual-link 90.90.90.90 retransmit-interval 300
!
ipv6 router ospf 999
  default-information originate always
  router-id 10.10.10.10
FTOS#
```

Use the following commands in EXEC Privilege mode to get general route and links status information.

| Command Syntax | Command Mode | Usage |
|-----------------------|----------------|---|
| show ip route summary | EXEC Privilege | View the summary information of the IP routes |

| Command Syntax | Command Mode | Usage |
|-----------------------|----------------|--|
| show ip ospf database | EXEC Privilege | View the summary information for the OSPF database |

Use the following command in EXEC Privilege mode to view the OSPFv2 configuration for a neighboring router:

| Command Syntax | Command Mode | Usage |
|-----------------------|----------------|---|
| show ip ospf neighbor | EXEC Privilege | View the configuration of OSPF neighbors connected to the local router. |

Use the following command in EXEC Privilege mode to view the OSPFv2 configuration for LSA throttling:

| Command Syntax | Command Mode | Usage |
|--------------------------------|----------------|---------------------------------------|
| show ip ospf timers rate-limit | EXEC Privilege | View the LSAs currently in the queue. |

Use the following command in EXEC Privilege mode to configure the debugging options of an OSPFv2 process:

| Command Syntax | Command Mode | Usage |
|---|----------------|--|
| debug ip ospf <i>process-id</i> [event packet spf database-timers rate-limit] | EXEC Privilege | <p>View debug messages.</p> <p>To view debug messages for a specific OSPF process ID, enter <code>debug ip ospf <i>process-id</i></code>.</p> <p>If you do not enter a process ID, the command applies to the first OSPF process.</p> <p>To view debug messages for a specific operation, enter one of the optional keywords:</p> <ul style="list-style-type: none"> • event: view OSPF event messages • packet: view OSPF packet information. • spf: view shortest path first (spf) information. • database-timers rate-limit: view the LSAs currently in the queue |

Sample Configurations for OSPFv2

The following configurations are examples for enabling OSPFv2. These are not comprehensive directions. They are intended to give you a some guidance with typical configurations.

You can copy and paste from these examples to your CLI. Be sure you make the necessary changes to support your own IP Addresses, Interfaces, Names, etc.

Basic OSPFv2 Router Topology

The following illustration is a sample basic OSPFv2 topology.

Figure 33-20. Basic topology and CLI commands for OSPFv2

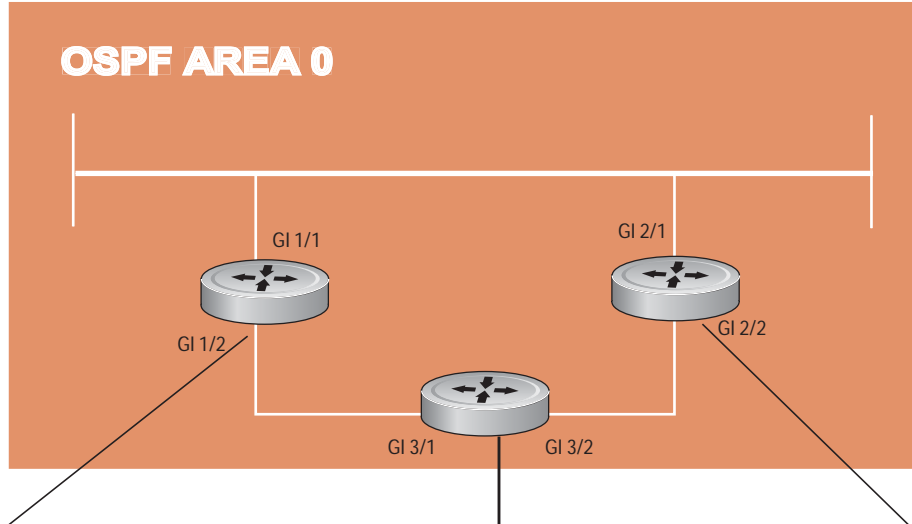

```
router ospf 11111
network 10.0.11.0/24 area 0
network 10.0.12.0/24 area 0
network 192.168.100.0/24 area 0
!
interface GigabitEthernet 1/1
ip address 10.1.11.1/24
no shutdown
!
interface GigabitEthernet 1/2
ip address 10.2.12.2/24
no shutdown
!
interface Loopback 10
ip address 192.168.100.100/24
no shutdown
```

```
router ospf 33333
network 192.168.100.0/24 area 0
network 10.0.13.0/24 area 0
network 10.0.23.0/24 area 0
!
interface Loopback 30
ip address 192.168.100.100/24
no shutdown
!
interface GigabitEthernet 3/1
ip address 10.1.13.3/24
no shutdown
!
interface GigabitEthernet 3/2
ip address 10.2.13.3/24
no shutdown
```

```
router ospf 22222
network 192.168.100.0/24 area 0
network 10.2.21.0/24 area 0
network 10.2.22.0/24 area 0
!
interface Loopback 20
ip address 192.168.100.20/24
no shutdown
!
interface GigabitEthernet 2/1
ip address 10.2.21.2/24
no shutdown
!
interface GigabitEthernet 2/2
ip address 10.2.22.2/24
no shutdown
```

PIM Sparse-Mode (PIM-SM)

PIM Sparse-Mode (PIM-SM) is supported on platforms: e C S **S4810** **S4820T**

PIM-Sparse Mode (PIM-SM) is a multicast protocol that forwards multicast traffic to a subnet only upon request using a PIM Join message; this behavior is the opposite of PIM-Dense Mode, which forwards multicast traffic to all subnets until a request to stop.

Implementation Information

- The Dell Force10 implementation of PIM-SM is based on the IETF *Internet Draft draft-ietf-pim-sm-v2-new-05*.
- C-Series supports a maximum of 31 PIM interfaces and 4K multicast entries including (*,G), and (S,G) entries. There is no limit on the number of PIM neighbors C-Series can have.
- S-Series supports a maximum of 31 PIM interfaces and 2K multicast entries including (*,G), and (S,G) entries. There is no limit on the number of PIM neighbors S-Series can have.
- E-Series supports a maximum of 511 PIM interfaces and 50K multicast entries including (*,G), (S,G), and (S,G,rpt) entries. There is no limit on the number of PIM neighbors E-Series can have.
- The SPT-Threshold is zero, which means that the last-hop designated router (DR) joins the shortest path tree (SPT) to the source upon receiving the first multicast packet.
- FTOS reduces the number of control messages sent between multicast routers by bundling Join and Prune requests in the same message.
- FTOS supports PIM-SM on physical, VLAN, and port-channel interfaces.
- FTOS supports 2000 IPv6 multicast forwarding entries, with up to 128 PIM-SSM neighbors/interfaces.
- PIM-SM on VLAN interfaces is supported on the E-Series on TeraScale platforms only.
- IPv6 Multicast is not supported on SONET interfaces.

Protocol Overview

PIM-SM initially uses unidirectional shared trees to forward multicast traffic; that is, all multicast traffic must flow only from the Rendezvous Point (RP) to the receivers. Once a receiver receives traffic from the RP, PIM-SM switches to shortest path trees (SPT) to forward multicast traffic. Every multicast group has an RP and a unidirectional shared tree (group-specific shared tree).

Requesting Multicast Traffic

A host requesting multicast traffic for a particular group sends an IGMP Join message to its gateway router. The gateway router is then responsible for joining the shared tree to the RP (RPT) so that the host can receive the requested traffic.

1. Upon receiving an IGMP Join message, the receiver gateway router (last-hop DR) creates a (*,G) entry in its multicast routing table for the requested group. The interface on which the join message was received becomes the outgoing interface associated with the (*,G) entry.
2. The last-hop DR sends a PIM Join message to the RP. All routers along the way, including the RP, create an (*,G) entry in their multicast routing table, and the interface on which the message was received becomes the outgoing interface associated with the (*,G) entry. This process constructs an RPT branch to the RP.
3. If a host on the same subnet as another multicast receiver sends an IGMP report for the same multicast group, the gateway takes no action. If a router between the host and the RP receives a PIM Join message for which it already has a (*,G) entry, the interface on which the message was received is added to the outgoing interface list associated with the (*,G) entry, and the message is not (and does not need to be) forwarded towards the RP.

Refusing Multicast Traffic

A host requesting to leave a multicast group sends an IGMP Leave message to the last-hop DR. If the host is the only remaining receiver for that group on the subnet, the last-hop DR is responsible for sending a PIM Prune message up the RPT to prune its branch to the RP.

1. Upon receiving an IGMP Leave message, the gateway removes the interface on which it is received from the outgoing interface list of the (*,G) entry. If the (*,G) entry has no remaining outgoing interfaces, multicast traffic for that group is no longer forwarded to that subnet.
2. If the (*,G) entry has no remaining outgoing interfaces, the last-hop DR sends a PIM Prune message to towards the RP. All routers along the way remove the interface on which the message was received from the outgoing interface list of the (*,G) entry. If on any router there is at least one outgoing interface listed for that (*,G) entry, the Prune message is not forwarded.

Sending Multicast Traffic

With PIM-SM, all multicast traffic must initially originate from the RP. A source must unicast traffic to the RP so that the RP can learn about the source and create an SPT to it. Then the last-hop DR may create an SPT directly to the source.

1. The source gateway router (first-hop DR) receives the multicast packets and creates an (S,G) entry in its multicast routing table. The first-hop DR encapsulates the initial multicast packets in PIM Register packets and unicasts them to the RP.
2. The RP decapsulates the PIM Register packets and forwards them if there are any receivers for that group. The RP sends a PIM Join message towards the source. All routers between the RP and the

source, including the RP, create an (S,G) entry and list the interface on which the message was received as an outgoing interface, thus recreating a SPT to the source.

3. Once the RP starts receiving multicast traffic via the (S,G) it unicasts a Register-Stop message to the first-hop DR so that multicast packets are no longer encapsulated in PIM Register packets and unicast. Upon receiving the first multicast packet from a particular source, the last-hop DR sends a PIM Join message to the source to create an SPT to it.
4. There are two paths, then, between the receiver and the source, a direct SPT and an RPT. One router will receive a multicast packet on two interfaces from the same source in this case; this router prunes the shared tree by sending a PIM Prune message to the RP that tells all routers between the source and the RP to remove the outgoing interface from the (*,G) entry, and tells the RP to prune its SPT to the source with a Prune message.

FTOS Behavior: When the router creates an SPT to the source, there are then two paths between the receiver and the source, the SPT and the RPT. Until the router can prune itself from the RPT, the receiver receives duplicate multicast packets which may cause disruption. Therefore, the router must prune itself from the RPT as soon as possible. FTOS optimizes the shared to shortest-path tree switchover latency by copying and forwarding the first (S,G) packet received on the SPT to the PIM task immediately upon arrival. The arrival of the (S,G) packet confirms for PIM that the SPT is created, and that it can prune itself from the shared tree.

Important Points to Remember

- If a loopback interface with a /32 mask is used as the RP, you must enable PIM Sparse-mode on the interface.

Configure PIM-SM

Configuring PIM-SM is a two-step process:

1. Enable multicast routing using the command `ip multicast-routing` from CONFIGURATION mode.
2. Select a Rendezvous Point.
3. Enable PIM-SM on an interface. See page 720.

Related Configuration Tasks

- [Configurable S,G Expiry Timers on page 721](#)
- [Configure a Static Rendezvous Point on page 722](#)
- [Configure a Designated Router on page 723](#)
- [Create Multicast Boundaries and Domains on page 724](#)
- [PIM-SM Graceful Restart on page 724](#)
- [Monitoring PIM on page 725](#)

Enable PIM-SM

You must enable PIM-SM on each participating interface:

| Step | Task | Command | Command Mode |
|------|---|----------------------|---------------|
| 1 | Enable multicast routing on the system. | ip multicast-routing | CONFIGURATION |
| 2 | Enable PIM-Sparse Mode | ip pim sparse-mode | INTERFACE |

Display which interfaces are enabled with PIM-SM using the command `show ip pim interface` from EXEC Privilege mode, as shown in [Figure 34-1](#).

Figure 34-1. Viewing PIM-SM Enabled Interfaces

```
FTOS#show ip pim interface
Address          Interface VIFindex Ver/  Nbr   Query  DR   DR
                Mode     Count  Intvl Prio
189.87.5.6       Gi 4/11  0x2    v2/S  1     30     1   127.87.5.6
189.87.3.2       Gi 4/12  0x3    v2/S  1     30     1   127.87.3.5
189.87.31.6      Gi 7/11  0x0    v2/S  0     30     1   127.87.31.6
189.87.50.6      Gi 7/13  0x4    v2/S  1     30     1   127.87.50.6
FTOS#
```



Note: You can influence the selection of the Rendezvous Point by enabling PIM-Sparse Mode on a loopback interface and assigning a low IP address.

Display PIM neighbors for each interface using the command `show ip pim neighbor` from EXEC Privilege mode, as shown in [Figure 34-2](#).

Figure 34-2. Viewing PIM Neighbors Command Example

```
FTOS#show ip pim neighbor
Neighbor        Interface      Uptime/Expires  Ver  DR
Address         Prio/Mode
127.87.5.5      Gi 4/11        01:44:59/00:01:16 v2   1 / S
127.87.3.5      Gi 4/12        01:45:00/00:01:16 v2   1 / DR
127.87.50.5    Gi 7/13        00:03:08/00:01:37 v2   1 / S
FTOS#
```

Display the PIM routing table using the command `show ip pim tib` from EXEC privilege mode, as shown in [Figure 34-3](#).

Figure 34-3. Viewing the PIM Multicast Routing Table

```

FTOS#show ip pim tib

PIM Multicast Routing Table
Flags: D - Dense, S - Sparse, C - Connected, L - Local, P - Pruned,
      R - RP-bit set, F - Register flag, T - SPT-bit set, J - Join SPT,
Timers: Uptime/Expires
Interface state: Interface, next-Hop, State/Mode

(*, 192.1.2.1), uptime 00:29:36, expires 00:03:26, RP 10.87.2.6, flags: SCJ
  Incoming interface: GigabitEthernet 4/12, RPF neighbor 10.87.3.5
  Outgoing interface list:
    GigabitEthernet 4/11
    GigabitEthernet 7/13

(10.87.31.5, 192.1.2.1), uptime 00:01:24, expires 00:02:26, flags: FT
  Incoming interface: GigabitEthernet 7/11, RPF neighbor 0.0.0.0
  Outgoing interface list:
    GigabitEthernet 4/11
    GigabitEthernet 4/12
    GigabitEthernet 7/13
--More--

```

Configurable S,G Expiry Timers

By default S, G entries expire in 210 seconds. You can configure a global expiry time (for all (S,G) entries) or configure a expiry time for a particular entry. If both are configured, the ACL supercedes the global configuration for the specified entries.

When an expiry time created, deleted, or updated, the changes are applied when the keep alive timer refreshes.

To configure a global expiry time:

| Task | Command | Command Mode |
|--|--|---------------|
| Enable global expiry timer for S, G entries Range 211-86400 seconds Default: 210 | ip pim sparse-mode sg-expiry-timer <i>seconds</i> | CONFIGURATION |

Configure the expiry time for a particular (S,G) entry:

| Step | Task | Command Syntax | Command Mode |
|------|---|--|-----------------|
| 1 | Create an Extended ACL | ip access-list extended <i>access-list-name</i> | CONFIGURATION |
| 2 | Specify the source and group to which the timer will be applied using extended ACLs with permit rules only. | [seq <i>sequence-number</i>] permit ip <i>source-address/mask</i> any host <i>source-address</i> ; { <i>destination-address/mask</i> any host <i>destination-address</i> } | CONFIG-EXT-NACL |

| Step | Task | Command Syntax | Command Mode |
|---|--|--|---------------|
| 3 | Set the expiry time for a specific (S,G) entry (Figure 34-4). Range 211-86400 seconds Default: 210 | <code>ip pim sparse-mode sg-expiry-timer <i>seconds</i> sg-list <i>access-list-name</i></code> | CONFIGURATION |
|  | <p>Note: The expiry time configuration is nullified, and the default global expiry time is used if:</p> <ul style="list-style-type: none"> an ACL is specified for an in the <code>ip pim sparse-mode sg-expiry-timer</code> command, but the ACL has not been created or is a standard ACL. if the expiry time is specified for an (S,G) entry in a deny rule. | | |

Figure 34-4. Configuring an (S,G) Expiry Time

```

FTOS(conf)#ip access-list extended SGtimer
FTOS(config-ext-nacl)#permit ip 10.1.2.3/24 225.1.1.0/24
FTOS(config-ext-nacl)#permit ip any 232.1.1.0/24
FTOS(config-ext-nacl)#permit ip 100.1.1.0/16 any
FTOS(config-ext-nacl)#show conf
!
ip access-list extended SGtimer
  seq 5 permit ip 10.1.2.0/24 225.1.1.0/24
  seq 10 permit ip any 232.1.1.0/24
  seq 15 permit ip 100.1.0.0/16 any
FTOS(config-ext-nacl)#exit

FTOS(conf)#ip pim sparse-mode sg-expiry-timer 1800 sg-list SGtimer

```

Display the expiry time configuration using the `show running-configuration [acl | pim]` command from EXEC Privilege mode.

Configure a Static Rendezvous Point

The rendezvous point is a PIM-enabled interface on a router that acts as the root a group-specific tree; every group must have an RP.

Identify an RP by the IP address of a PIM-enabled or loopback interface using the command `ip pim rp-address`, as shown in Figure 34-5.

Figure 34-5. Electing a Rendezvous Point

```

FTOS#sh run int loop0
!
interface Loopback 0
  ip address 1.1.1.1/32
  ip pim sparse-mode
  no shutdown
FTOS#sh run pim
!
ip pim rp-address 1.1.1.1 group-address 224.0.0.0/4

```

Override Bootstrap Router Updates

PIM-SM routers need to know the address of the RP for each group for which they have (*,G) entry. This address is obtained automatically through the bootstrap router (BSR) mechanism or a static RP configuration.

If you have configured a static RP for a group, use the option `override` with the command `ip pim rp-address` to override bootstrap router updates with your static RP configuration. If you do not use this option, the RPs advertised in the BSR updates take precedence over any statically configured RPs.

Display the assigned RP for a group using the command `show ip pim rp` from EXEC privilege mode, as shown in [Figure 34-6](#).

Figure 34-6. Displaying the Rendezvous Point for a Multicast Group

```
FTOS#show ip pim rp
Group          RP
225.0.1.40     165.87.50.5
226.1.1.1     165.87.50.5
```

Display the assigned RP for a group range (group-to-RP mapping) using the command `show ip pim rp mapping` command in EXEC privilege mode

Figure 34-7. Display the Rendezvous Point for a Multicast Group Range

```
FTOS#show ip pim rp mapping
PIM Group-to-RP Mappings
Group(s): 224.0.0.0/4, Static
RP: 165.87.50.5, v2
```

Configure a Designated Router

Multiple PIM-SM routers might be connected to a single LAN segment. One of these routers is elected to act on behalf of directly connected hosts. This router is the Designated Router (DR).

The DR is elected using hello messages. Each PIM router learns about its neighbors by periodically sending a hello message out of each PIM-enabled interface. Hello messages contain the IP address of the interface out of which it is sent and a DR priority value. The router with the greatest priority value is the DR. If the priority value is the same for two routers, then the router with the greatest IP address is the DR. By default the DR priority value is 192, so the IP address determines the DR.

- Assign a DR priority value using the command `ip pim dr-priority priority-value` from INTERFACE mode.
- Change the interval at which a router sends hello messages using the command `ip pim query-interval seconds` from INTERFACE mode.
- Display the current value of these parameter using the command `show ip pim interface` EXEC Privilege mode.

Create Multicast Boundaries and Domains

A PIM domain is a contiguous set of routers that all implement PIM and are configured to operate within a common boundary defined by PIM Multicast Border Routers (PMBRs). PMBRs connect each PIM domain to the rest of the internet.

Create multicast boundaries and domains by filtering inbound and outbound Bootstrap Router (BSR) messages per interface, use the `ip pim bsr-border` command. This command is applied to the subsequent inbound and outbound updates. Already existing BSR advertisements are removed by timeout.

Remove candidate RP advertisements using the `clear ip pim rp-mapping` command.

PIM-SM Graceful Restart

PIM-SM Graceful Restart is supported only on platform 

PIM-SM Graceful Restart is supported only on platform  \times with FTOS 8.2.1.0 and later.

When a PIM neighbor restarts and the liveliness timer for that neighbor expires, the join/prune states received from the neighbor expire, and the corresponding interfaces are removed from the outgoing list of multicast entries. The effect of this is that active multicast sessions are brought down.

FTOS supports PIM-SM graceful restart based on the GenID. Per RFC 4601, hello messages should contain a `Generation_Identifier` option, which contains a randomly generated value (GenID) that is regenerated each time PIM forwarding is started or restarted on the interface, including when the router restarts. When a router receives from a neighbor a hello message with a new GenID, any old hello information about that neighbor should be discarded and superseded by the information from the new hello message.

FTOS supports graceful restart based on the GenID. A Dell Force10 PIM router announces its graceful restart capability to its neighbors up front as an option in its hello messages.

If a graceful-restart capable router recognizes that a graceful-restart capable neighbor has restarted, it preserves the state from the neighbor and continues forwarding multicast traffic while the neighbor restarts.

- The router holds on to the entries learned from the neighbor for the graceful restart interval. If it does not receive a hello from the neighbor within this time, it purges all state associated with the neighbor.
- If the neighbor restarts and sends a hello with a new GenID before this interval expires, the router sends a join message towards the neighbor for the relevant entries.

If a graceful-restart capable router restarts, the router preserves all multicast entries in hardware until it receives and consolidates joins from its graceful-restart capable neighbors. The router is not taken off the forwarding path during restart.

Enable PIM-SM graceful restart (non-stop forwarding capability) using the command `ip pim graceful-restart nsf` from CONFIGURATION mode. There are two options with this command:

- `restart-time` is the time required by the Dell Force10 system to restart. The default value is 180 seconds.
- `stale-entry-time` is the maximum amount of time that the Dell Force10 system preserves entries from a restarting neighbor. The default value is 60 seconds.

In helper-only mode, the system preserves the PIM states of a neighboring router while the neighbor gracefully restarts, but the Dell Force10 system allows itself to be taken off the forwarding path if it restarts. Enable this mode using the command `ip pim graceful-restart helper-only`. This mode takes precedence over any graceful restart configuration.

Monitoring PIM

The PIM MIB is supported only on platform .

FTOS fully supports the PIM MIB as specified in RFC 5060 with some exceptions.

- The following tables are not supported:
 - `pimBidirDFElectionTable`
 - `pimAnycastRPSetTable`
- The OIDs related to `InvalidRegisterMsgs` reflect the last received invalid register message. Similarly, the OIDs related to `InvalidJoinPruneMsgs` reflect the last received invalid Join or Prune message.
- OIDs which refer to any timer show the time that the timer started; it is 0 otherwise.

Port Monitoring

Port Monitoring is supported on platforms: **E C S** **S4810** **S4820T**

Port Monitoring is a feature that copies all incoming or outgoing packets on one port and forwards (mirrors) them to another port. The source port is the monitored port (MD) and the destination port is the monitoring port (MG). Port Monitoring functionality is different between platforms, but the behavior is the same, with highlighted exceptions.

This chapter is divided into the following sections:

- [Important Points to Remember on page 727](#)
- [Port Monitoring on E-Series on page 728](#)
- [Port Monitoring on C-Series and S-Series on page 729](#)
- [Configuring Port Monitoring on page 732](#)
- [Flow-based Monitoring on page 733](#)

Important Points to Remember

- On the E-Series, Port Monitoring is supported on TeraScale and ExaScale platforms.
- Port Monitoring is supported on physical ports only; VLAN and port-channel interfaces do not support port monitoring.
- A SONET port may only be a monitored port.
- The Monitored (source, “MD”) and Monitoring ports (destination, “MG”) must be on the same switch.
- In general, a monitoring port should have no ip address and no shutdown as the only configuration; FTOS permits a limited set of commands for monitoring ports; display them using the command ?. A monitoring port also may not be a member of a VLAN.
- There may only be one destination port in a monitoring session.
- A source port (MD) can only be monitored by one destination port (MG). The following error is displayed if you try to assign a monitored port to more than one monitoring port.

```

FTOS(conf)#mon ses 1
FTOS(conf-mon-sess-1)#$gig 0/0 destination gig 0/60 direction both
FTOS(conf-mon-sess-1)#do show mon ses
      SessionID      Source      Destination      Direction      Mode      Type
      -----      -
              1      Gi 0/0      Gi 0/60      both      interface      Port-based
FTOS(conf-mon-sess-1)#mon ses 2
FTOS(conf-mon-sess-2)#source gig 0/0 destination gig 0/61 direction both
% Error: MD port is already being monitored.

```

- The C-Series and S-Series may only have four destination ports per port-pipe. There is no limitation on the total number of monitoring sessions.

Table 35-1 lists the maximum number of monitoring sessions per system. For the C-Series and S-Series, the total number of sessions is derived by consuming a unique destination port in each session, in each port-pipe.

Table 35-1. Maximum Number of Monitoring Sessions per System

| System | Maximum Sessions | System | Maximum Sessions |
|------------------|------------------|--------------------------|------------------|
| C150 | ∞ (Note) | E1200/E1200i (TeraScale) | 28 |
| C300 | ∞ (Note) | E1200i (ExaScale) | ∞ |
| S50V, S50N | ∞ (Note) | E600/E600i (TeraScale) | 14 |
| S25P | ∞ (Note) | E600i (ExaScale) | ∞ |
| S55 | ∞ (Note) | E300 | 6 |
| S60 | ∞ (Note) | | |
| S4810 and S4820T | ∞ (Note) | | |



Note: On the C-Series and S-Series, there is no limit to the number of monitoring sessions per system, provided that there are only 4 destination ports per port-pipe. If each monitoring session has a unique destination port, then the maximum number of session is 4 per port-pipe.

Port Monitoring on E-Series

Both the E-Series TeraScale and E-Series ExaScale support the following.

- FTOS supports one destination (MG) port per monitoring session. The same destination port (MG) can be used in another monitoring session.
- One destination (MG) port can monitor up to 28 source (MD) ports.
- A port cannot be defined as both a source (MD) and a destination (MG) port ([Message 1](#)).

Message 1 Cannot define source (MD) and destination (MG) on same port

```
% Error: MD port is already being monitored.
```

E-Series TeraScale

The E-Series TeraScale system supports 1 monitoring session per port-pipe. E-Series TeraScale supports a maximum of 28 port pipes.

On the E-Series TeraScale, FTOS supports a single source-destination statement in a monitor session (Message 2). E-Series TeraScale supports only one source and one destination port per port-pipe (Message 3). Therefore, the E-Series TeraScale supports as many monitoring sessions as there are port-pipes in the system.

Message 2 Multiple Source-Destination Statements Error Message on E-Series TeraScale

```
% Error: Remove existing monitor configuration.
```

Message 3 One Source/Destination Port per Port-pipe Error Message on E-Series TeraScale

```
% Error: Some port from this port pipe is already configured as MD.
% Error: Some port from this port pipe is already configured as MG.
```

Figure 35-1 illustrates a possible port monitoring configuration on the E-Series.

Figure 35-1. Port Monitoring Configurations on the E-Series

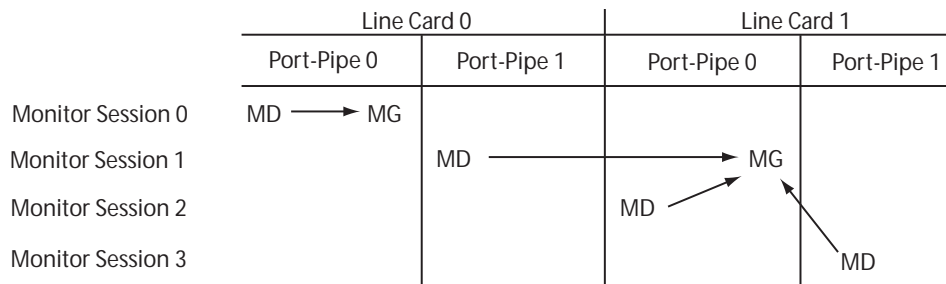

Port Monitoring 002

E-Series ExaScale

FTOS on E-Series ExaScale supports a single destination (MG) port monitoring multiple multiple source (MD) ports in one monitor session. One monitor session can have only one destination (MG) port. The same destination (MG) port can be uses with multiple monitoring sessions.

There is no restriction on the number of source (MD) or destination (MG) ports on the chassis because there is no port-pipe restriction on the E-Series ExaScale system.

There is no restriction to the number of monitoring sessions supported on the E-Series ExaScale system.

Port Monitoring on C-Series and S-Series

The C-Series and S-Series support multiple source-destination statements in a monitor session, but there may only be one destination port in a monitoring session (Message 4).

Message 4 One Destination Port in a Monitoring Session Error Message on C-Series and S-Series

```
% Error: Only one MG port is allowed in a session.
```

The number of source ports FTOS allows within a port-pipe is equal to the number of physical ports in the port-pipe (n). However, n number of ports may only have four different destination ports ([Message 5](#)).

Figure 35-2. Number of Monitoring Ports on the C-Series and S-Series

```
FTOS#show mon session
  SessionID      Source      Destination      Direction      Mode      Type
  -----      -
      0          Gi 0/13      Gi 0/1           rx            interface  Port-based
     10          Gi 0/14      Gi 0/2           rx            interface  Port-based
     20          Gi 0/15      Gi 0/3           rx            interface  Port-based
     30          Gi 0/16      Gi 0/37          rx            interface  Port-based

FTOS(conf)#mon ses 300
FTOS(conf-mon-sess-300)#source gig 0/17 destination gig 0/4 direction tx
% Error: Exceeding max MG ports for this MD port pipe.
FTOS(conf-mon-sess-300)#
FTOS(conf-mon-sess-300)#source gig 0/17 destination gig 0/1 direction tx
FTOS(conf-mon-sess-300)#do show mon session
  SessionID      Source      Destination      Direction      Mode      Type
  -----      -
      0          Gi 0/13      Gi 0/1           rx            interface  Port-based
     10          Gi 0/14      Gi 0/2           rx            interface  Port-based
     20          Gi 0/15      Gi 0/3           rx            interface  Port-based
     30          Gi 0/16      Gi 0/37          rx            interface  Port-based
    300          Gi 0/17      Gi 0/1           tx            interface  Port-based

FTOS(conf-mon-sess-300)#
```

In [Figure 35-2](#), ports 0/13, 0/14, 0/15, and 0/16 all belong to the same port-pipe. They are pointing to four different destinations (0/1, 0/2, 0/3, and 0/37). Now it is not possible for another source port from the same port-pipe (for example, 0/17) to point to another new destination (for example, 0/4). If you attempt to configure another destination, [Message 5](#) appears. However, you can configure another monitoring session that uses one of previously used destination ports, as shown in [Figure 35-3](#).

Figure 35-3. Number of Monitoring Ports on the C-Series and S-Series

```
FTOS(conf)#mon ses 300
FTOS(conf-mon-sess-300)#source gig 0/17 destination gig 0/4 direction tx
% Error: Exceeding max MG ports for this MD port pipe.
FTOS(conf-mon-sess-300)#
FTOS(conf-mon-sess-300)#source gig 0/17 destination gig 0/1 direction tx
FTOS(conf-mon-sess-300)#do show mon session
  SessionID      Source      Destination      Direction      Mode      Type
  -----      -
      0          Gi 0/13      Gi 0/1           rx            interface  Port-based
     10          Gi 0/14      Gi 0/2           rx            interface  Port-based
     20          Gi 0/15      Gi 0/3           rx            interface  Port-based
     30          Gi 0/16      Gi 0/37          rx            interface  Port-based
    300          Gi 0/17      Gi 0/1           tx            interface  Port-based
```

In [Figure 35-4](#), 0/25 and 0/26 belong to Port-pipe 1. This port-pipe again has the same restriction of only four destination ports, new or used.

Figure 35-4. Number of Monitoring Ports on the C-Series and S-Series

```

FTOS (conf-mon-sess-300) #do show mon session
  SessionID      Source      Destination      Direction      Mode      Type
  -----      -
          0      Gi 0/13      Gi 0/1      rx      interface      Port-based
          10     Gi 0/14     Gi 0/2      rx      interface      Port-based
          20     Gi 0/15     Gi 0/3      rx      interface      Port-based
          30     Gi 0/16     Gi 0/37     rx      interface      Port-based
          100    Gi 0/25     Gi 0/38     tx      interface      Port-based
          110    Gi 0/26     Gi 0/39     tx      interface      Port-based
          300    Gi 0/17     Gi 0/1      tx      interface      Port-based
FTOS (conf-mon-sess-300) #

```

A source port may only be monitored by one destination port (Message 6), but a destination port may monitor more than one source port. Given these parameters, Figure 35-1 illustrates conceptually the possible port monitoring configurations on the C-Series and S-Series.

Message 5 One Destination Port in a Monitoring Session Error Message on C-Series and S-Series

```

% Error: Exceeding max MG ports for this MD port pipe.

```

Message 6 One Destination Port per Source Port Error Message

```

% Error: MD port is already being monitored.

```

Figure 35-5. Port Monitoring Configurations on the C-Series and S-Series

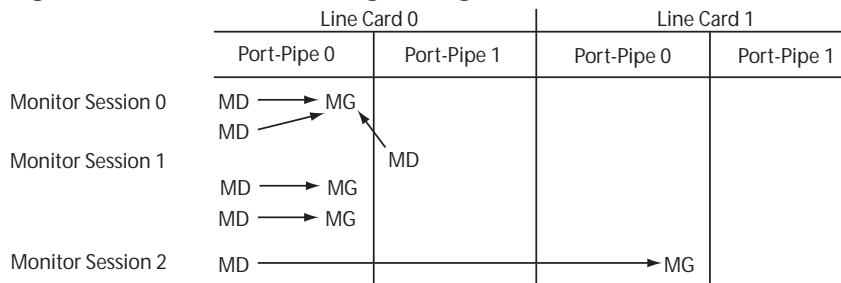

Port Monitoring 003

FTOS Behavior: On the C-Series and S-Series, all monitored frames are tagged if the configured monitoring direction is transmit (TX), regardless of whether the monitored port (MD) is a Layer 2 or Layer 3 port. If the MD port is a Layer 2 port, the frames are tagged with the VLAN ID of the VLAN to which the MD belongs. If the MD port is a Layer 3 port, the frames are tagged with VLAN ID 4095. If the MD port is in a Layer 3 VLAN, the frames are tagged with the respective Layer 3 VLAN ID. For example, in the configuration *source gig 6/0 destination gig 6/1 direction tx*, if the MD port gigabitethernet 6/0 is an untagged member of any VLAN, all monitored frames that the MG port gigabitethernet 6/1 receives are tagged with the VLAN ID of the MD port. Similarly, if BPDUs are transmitted, the MG port receives them tagged with the VLAN ID 4095. This behavior might result in a difference between the number of egress packets on the MD port and monitored packets on the MG port.

FTOS Behavior: The C-Series and S-Series continue to mirror outgoing traffic even after an MD participating in Spanning Tree Protocol transitions from the forwarding to blocking.

Configuring Port Monitoring

To configure port monitoring:

| Step | Task | Command Syntax | Command Mode |
|------|--|-----------------|-----------------|
| 1 | Verify that the intended monitoring port has no configuration other than no shutdown, as shown in Figure 35-6 . | show interface | EXEC Privilege |
| 2 | Create a monitoring session using the command monitor session from CONFIGURATION mode, as shown in Figure 35-6 . | monitor session | CONFIGURATION |
| 3 | Specify the source and destination port and direction of traffic, as shown in Figure 35-6 . | source | MONITOR SESSION |

Display monitor sessions using the command show monitor session from EXEC Privilege mode, as shown in [Figure 35-6](#).

Figure 35-6. Configuring Port-based Monitoring

```

FTOS (conf-if-gi-1/2) #show config
!
interface GigabitEthernet 1/2
 no ip address
 no shutdown
FTOS (conf-if-gi-1/2) #exit
FTOS (conf) #monitor session 0
FTOS (conf-mon-sess-0) #source gig 1/1 dest gig 1/2 direction rx
FTOS (conf-mon-sess-0) #exit
FTOS (conf) #do show monitor session 0
  SessionID      Source      Destination  Direction  Mode      Type
  -----      -
  0              Gi 1/1     Gi 1/2      rx         interface Port-based
FTOS (conf) #

```

In [Figure 35-7](#), the host and server are exchanging traffic which passes through interface gigabitethernet 1/1. Interface gigabitethernet 1/1 is the monitored port and gigabitethernet 1/2 is the monitoring port, which is configured to only monitor traffic received on gigabitethernet 1/1 (host-originated traffic).

Figure 35-7. Port Monitoring Example

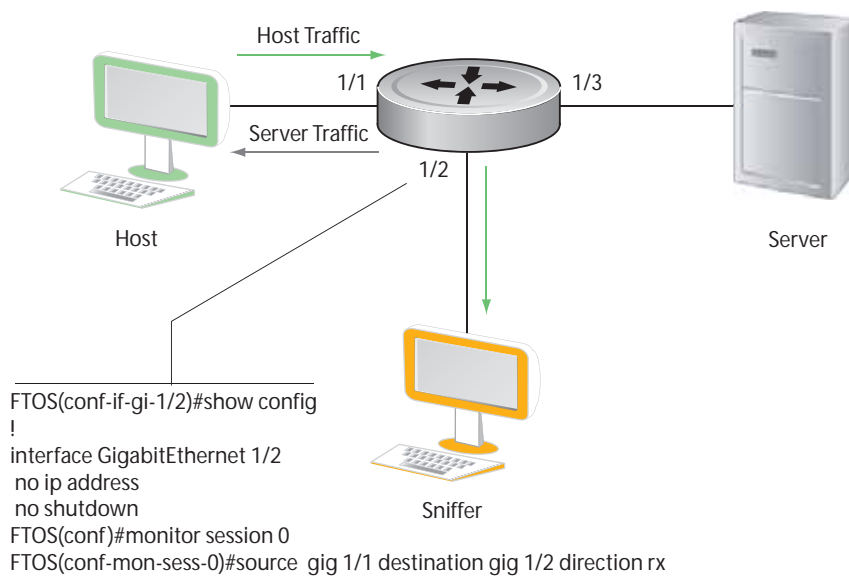

Port Monitoring 001

Flow-based Monitoring

Flow-based Monitoring is supported only on platform **e**

Flow-based monitoring conserves bandwidth by monitoring only specified traffic instead all traffic on the interface. This feature is particularly useful when looking for malicious traffic. It is available for Layer 2 and Layer 3 ingress and egress traffic. You may specify traffic using standard or extended access-lists.

To configure flow-based monitoring:

| Step | Task | Command Syntax | Command Mode |
|------|--|--------------------------------|-----------------|
| 4 | Enable flow-based monitoring for a monitoring session. | flow-based enable | MONITOR SESSION |
| 5 | Define in an access-list rules that include the keyword monitor. FTOS only considers for port monitoring traffic matching rules with the keyword monitor. See Chapter 7, Access Control Lists (ACLs) . | ip access-list | CONFIGURATION |
| 6 | Apply the ACL to the monitored port. See Chapter 7, Access Control Lists (ACLs) . | ip access-group access-list | INTERFACE |

View an access-list that you applied to an interface using the command `show ip accounting access-list` from EXEC Privilege mode, as shown in [Figure 35-8](#).

Figure 35-8. Configuring Flow-based Monitoring

```

FTOS(conf)#monitor session 0
FTOS(conf-mon-sess-0)#flow-based enable
FTOS(conf)#ip access-list ext testflow
FTOS(config-ext-nacl)#seq 5 permit icmp any any count bytes monitor
FTOS(config-ext-nacl)#seq 10 permit ip 102.1.1.0/24 any count bytes monitor
FTOS(config-ext-nacl)#seq 15 deny udp any any count bytes
FTOS(config-ext-nacl)#seq 20 deny tcp any any count bytes
FTOS(config-ext-nacl)#exit
FTOS(conf)#interface gig 1/1
FTOS(conf-if-gi-1/1)#ip access-group testflow in
FTOS(conf-if-gi-1/1)#show config
!
interface GigabitEthernet 1/1
 ip address 10.11.1.254/24
 ip access-group testflow in
 shutdown
FTOS(conf-if-gi-1/1)#exit
FTOS(conf)#do show ip accounting access-list testflow
!
Extended Ingress IP access list testflow on GigabitEthernet 1/1
Total cam count 4
 seq 5 permit icmp any any monitor count bytes (0 packets 0 bytes)
 seq 10 permit ip 102.1.1.0/24 any monitor count bytes (0 packets 0 bytes)
 seq 15 deny udp any any count bytes (0 packets 0 bytes)
 seq 20 deny tcp any any count bytes (0 packets 0 bytes)
FTOS(conf)#do show monitor session 0

```

| SessionID | Source | Destination | Direction | Mode | Type |
|-----------|--------|-------------|-----------|-----------|------------|
| 0 | Gi 1/1 | Gi 1/2 | rx | interface | Flow-based |

Private VLANs (PVLAN)

The **Private VLANs (PVLAN)** feature is supported on platforms **C S** **S4810** **S4820T**

For syntax details on the commands discussed in this chapter, see the Private VLANs Commands chapter in the *FTOS Command Line Reference*.

This chapter contains the following major sections:

- [Private VLAN Concepts on page 735](#)
- [Private VLAN Commands on page 737](#)
- [Private VLAN Configuration Task List on page 738](#)
- [Private VLAN Configuration Example on page 741](#)
- [Inspecting the Private VLAN Configuration on page 742](#)

Private VLANs extend the FTOS security suite by providing Layer 2 isolation between ports within the same VLAN. A private VLAN partitions a traditional VLAN into subdomains identified by a *primary* and *secondary VLAN* pair. Private VLANs block all traffic to isolated ports except traffic from promiscuous ports. Traffic received from an isolated port is forwarded only to promiscuous ports or trunk ports.

Example uses of PVLANS:

- A hotel can use an isolated VLAN in a private VLAN to provide Internet access for its guests, while stopping direct access between the guest ports.
- A service provider can provide Layer 2 security for customers and use the IP addresses more efficiently, by using a separate community VLAN per customer, while at the same time using the same IP subnet address space for all community and isolated VLANs mapped to the same primary VLAN. In more detail, community VLANs are especially useful in the service provider environment, because, multiple customers are likely to maintain servers that must be strictly separated in customer-specific groups. A set of servers owned by a customer could comprise a community VLAN, so that those servers could communicate with each other, and would be isolated from other customers. Another customer might have another set of servers in another community VLAN. Another customer might want an isolated VLAN, which is has one or more ports that are also isolated from each other.

Private VLAN Concepts

The VLAN types in a private VLAN (PVLAN) include:

Community VLAN — A *community VLAN* is a type of secondary VLAN in a primary VLAN:

- Ports in a community VLAN can communicate with each other.
- Ports in a community VLAN can communicate with all promiscuous ports in the primary VLAN.
- A community VLAN can only contain ports configured as **host**.

Isolated VLAN — An *isolated VLAN* is a type of secondary VLAN in a primary VLAN:

- Ports in an isolated VLAN cannot talk directly to each other.
- Ports in an isolated VLAN can only communicate with promiscuous ports in the primary VLAN.
- An isolated VLAN can only contain ports configured as **host**.

Primary VLAN—A *primary VLAN* is the base VLAN of a private VLAN:

- A switch can have one or more primary VLANs, and it can have none.
- A primary VLAN has one or more secondary VLANs.
- A primary VLAN and each of its secondary VLANs decrement the available number of VLAN IDs in the switch.
- A primary VLAN has one or more promiscuous ports.
- A primary VLAN might have one or more trunk ports, or none.

Secondary VLAN — A *secondary VLAN* is a subdomain of the primary VLAN. There are two types of secondary VLAN — community VLAN and isolated VLAN.

PVLAN port types:

- **Community port:** A *community port* is, by definition, a port that belongs to a community VLAN and is allowed to communicate with other ports in the same community VLAN and with promiscuous ports.
- **Host port:** A *host port*, in the context of a private VLAN, is a port in a secondary VLAN:
 - The port must first be assigned that role in INTERFACE mode.
 - A port assigned the host role cannot be added to a regular VLAN.
- **Isolated port:** An *isolated port* is, by definition, a port that, in Layer 2, can only communicate with promiscuous ports that are in the same PVLAN.
- **Promiscuous port:** A *promiscuous port* is, by definition, a port that is allowed to communicate with any other port type in the PVLAN:
 - A promiscuous port can be part of more than one primary VLAN.
 - A promiscuous port cannot be added to a regular VLAN.
- **Trunk port:** A *trunk port*, by definition, carries traffic between switches:
 - A trunk port in a PVLAN is always tagged.
 - Primary or secondary VLAN traffic is carried by the trunk port in tagged mode. The tag on the packet helps identify the VLAN to which the packet belongs.
 - A trunk port can also belong to a regular VLAN (non-private VLAN).

Each of the port types can be any type of physical Ethernet port, including port channels (LAGs). For details on port channels, see [Port Channel Interfaces on page 446](#) in [Chapter 22, Interfaces](#).

For an introduction to VLANs, see [Chapter 28, Layer 2](#).

Private VLAN Commands

The commands dedicated to supporting the Private VLANs feature are:

Table 36-1. Private VLAN Commands

| Task | Command Syntax | Command Mode |
|---|--|------------------------|
| Enable/disable Layer 3 communication between secondary VLANs. | [no] ip local-proxy-arp Note: Even after ip-local-proxy-arp is disabled (no ip-local-proxy-arp) in a secondary VLAN, Layer 3 communication may happen between some secondary VLAN hosts, until the ARP timeout happens on those secondary VLAN hosts. | INTERFACE VLAN |
| Set the mode of the selected VLAN to community, isolated, or primary. | [no] private-vlan mode {community isolated primary} | INTERFACE VLAN |
| Map secondary VLANs to the selected primary VLAN. | [no] private-vlan mapping secondary-vlan <i>vlan-list</i> | INTERFACE VLAN |
| Display type and status of PVLAN interfaces. | show interfaces private-vlan [interface <i>interface</i>] | EXEC EXEC Privilege |
| Display PVLANS and/or interfaces that are part of a PVLAN. | show vlan private-vlan [community interface isolated primary <i>primary_vlan</i> interface <i>interface</i>] | EXEC EXEC Privilege |
| Display primary-secondary VLAN mapping. | show vlan private-vlan mapping | EXEC EXEC Privilege |
| Set the PVLAN mode of the selected port. | switchport mode private-vlan {host promiscuous trunk} | INTERFACE |



Note: Secondary VLANs are Layer 2 VLANs, so even if they are operationally down while primary VLANs are operationally up, Layer 3 traffic will still be transmitted across secondary VLANs.

The outputs of the following commands are augmented in FTOS 7.8.1.0 to provide PVLAN data:

- **show arp:** See the IP Routing Commands chapter in the *FTOS Command Line Reference*.
- **show vlan:** See the Layer 2 Commands chapter in the *FTOS Command Line Reference*.

Private VLAN Configuration Task List

The following sections contain the procedures that configure a private VLAN:

- [Creating PVLAN ports](#)
- [Creating a Primary VLAN on page 739](#)
- [Creating a Community VLAN on page 740](#)
- [Creating an Isolated VLAN on page 740](#)

Creating PVLAN ports

Private VLAN ports are those that will be assigned to the private VLAN (PVLAN).

| Step | Command Syntax | Command Mode | Purpose |
|------|--|---------------|---|
| 1 | interface <i>interface</i> | CONFIGURATION | Access the INTERFACE mode for the port that you want to assign to a PVLAN. |
| 2 | no shutdown | INTERFACE | Enable the port. |
| 3 | switchport | INTERFACE | Set the port in Layer 2 mode. |
| 4 | switchport mode private-vlan {host promiscuous trunk} | INTERFACE | Select the PVLAN mode: <ul style="list-style-type: none"> • host (port in isolated or community VLAN) • promiscuous (intra-VLAN communication port) • trunk (inter-switch PVLAN hub port) |

For interface details, see [Enable a Physical Interface on page 438](#) in [Chapter 22, Interfaces](#).



Note: Interfaces that are configured as PVLAN ports cannot be added to regular VLANs. Conversely, “regular” ports (ports not configured as PVLAN ports) cannot be added to PVLANS.

[Figure 36-1](#) shows the use of the **switchport mode private-vlan** command on a port and on a port channel:

Figure 36-1. Examples of switchport mode private-vlan Command

```
FTOS#conf
FTOS(conf)#interface GigabitEthernet 2/1
FTOS(conf-if-gi-2/1)#switchport mode private-vlan promiscuous

FTOS(conf)#interface GigabitEthernet 2/2
FTOS(conf-if-gi-2/2)#switchport mode private-vlan host

FTOS(conf)#interface GigabitEthernet 2/3
FTOS(conf-if-gi-2/3)#switchport mode private-vlan trunk

FTOS(conf)#interface GigabitEthernet 2/2
FTOS(conf-if-gi-2/2)#switchport mode private-vlan host

FTOS(conf)#interface port-channel 10
FTOS(conf-if-po-10)#switchport mode private-vlan promiscuous
```

Creating a Primary VLAN

A primary VLAN is a port-based VLAN that is specifically enabled as a primary VLAN to contain the promiscuous ports and PVLAN trunk ports for the private VLAN. A primary VLAN also contains a mapping to secondary VLANs, which are comprised of community VLANs and isolated VLANs.

| Step | Command Syntax | Command Mode | Purpose |
|------|---|----------------|--|
| 1 | interface vlan <i>vlan-id</i> | CONFIGURATION | Access the INTERFACE VLAN mode for the VLAN to which you want to assign the PVLAN interfaces. |
| 2 | no shutdown | INTERFACE VLAN | Enable the VLAN. |
| 3 | private-vlan mode primary | INTERFACE VLAN | Set the PVLAN mode of the selected VLAN to primary. |
| 4 | private-vlan mapping secondary-vlan <i>vlan-list</i> | INTERFACE VLAN | Map secondary VLANs to the selected primary VLAN. The list of secondary VLANs can be: <ul style="list-style-type: none">Specified in comma-delimited (<i>VLAN-ID,VLAN-ID</i>) or hyphenated-range format (<i>VLAN-ID-VLAN-ID</i>).Specified with this command even before they have been created.Amended by specifying the new secondary VLAN to be added to the list. |
| 5 | tagged interface or untagged interface | INTERFACE VLAN | Add promiscuous ports as tagged or untagged interfaces. Add PVLAN trunk ports to the VLAN only as tagged interfaces. Interfaces can be entered singly or in range format, either comma-delimited (<i>slot/port,port,port</i>) or hyphenated (<i>slot/port-port</i>). Only promiscuous ports or PVLAN trunk ports can be added to the PVLAN (no host or regular ports). |
| 6 | ip address <i>ip address</i> | INTERFACE VLAN | (OPTIONAL) Assign an IP address to the VLAN. |
| 7 | ip local-proxy-arp | INTERFACE VLAN | (OPTIONAL) Enable/disable Layer 3 communication between secondary VLANs. |



Note: If a promiscuous or host port is untagged in a VLAN and it receives a tagged packet in the same VLAN, the packet will NOT be dropped.

Creating a Community VLAN

A community VLAN is a secondary VLAN of the primary VLAN in a private VLAN. The ports in a community VLAN can talk to each other and with the promiscuous ports in the primary VLAN.

| Step | Command Syntax | Command Mode | Purpose |
|------|--|----------------|---|
| 1 | interface vlan <i>vlan-id</i> | CONFIGURATION | Access the INTERFACE VLAN mode for the VLAN that you want to make a community VLAN. |
| 2 | no shutdown | INTERFACE VLAN | Enable the VLAN. |
| 3 | private-vlan mode community | INTERFACE VLAN | Set the PVLAN mode of the selected VLAN to community. |
| 4 | tagged <i>interface</i> or untagged <i>interface</i> | INTERFACE VLAN | Add one or more host ports to the VLAN. The interfaces can be entered singly or in range format, either comma-delimited (<i>slot/port,port,port</i>) or hyphenated (<i>slot/port-port</i>). Only host (isolated) ports can be added to the VLAN. |

Creating an Isolated VLAN

An isolated VLAN is a secondary VLAN of a primary VLAN. Its ports can only talk with the promiscuous ports in that primary VLAN.

| Step | Command Syntax | Command Mode | Purpose |
|------|--|----------------|---|
| 1 | interface vlan <i>vlan-id</i> | CONFIGURATION | Access the INTERFACE VLAN mode for the VLAN that you want to make an isolated VLAN. |
| 2 | no shutdown | INTERFACE VLAN | Enable the VLAN. |
| 3 | private-vlan mode isolated | INTERFACE VLAN | Set the PVLAN mode of the selected VLAN to isolated. |
| 4 | tagged <i>interface</i> or untagged <i>interface</i> | INTERFACE VLAN | Add one or more host ports to the VLAN. The interfaces can be entered singly or in range format, either comma-delimited (<i>slot/port,port,port</i>) or hyphenated (<i>slot/port-port</i>). Only ports defined as host can be added to the VLAN. |

Figure 36-2 shows the use of the PVLAN commands that are used in VLAN INTERFACE mode to configure the PVLAN member VLANs (primary, community, and isolated VLANs):

Figure 36-2. Configuring VLANs for a Private VLAN

```
FTOS#conf
FTOS(conf)# interface vlan 10
FTOS(conf-vlan-10)# private-vlan mode primary
FTOS(conf-vlan-10)# private-vlan mapping secondary-vlan 100-101
FTOS(conf-vlan-10)# untagged Gi 2/1
FTOS(conf-vlan-10)# tagged Gi 2/3

FTOS(conf)# interface vlan 101
FTOS(conf-vlan-101)# private-vlan mode community
FTOS(conf-vlan-101)# untagged Gi 2/10

FTOS(conf)# interface vlan 100
FTOS(conf-vlan-100)# private-vlan mode isolated
FTOS(conf-vlan-100)# untagged Gi 2/2
```

Private VLAN Configuration Example

Figure 36-3. Sample Private VLAN Topology

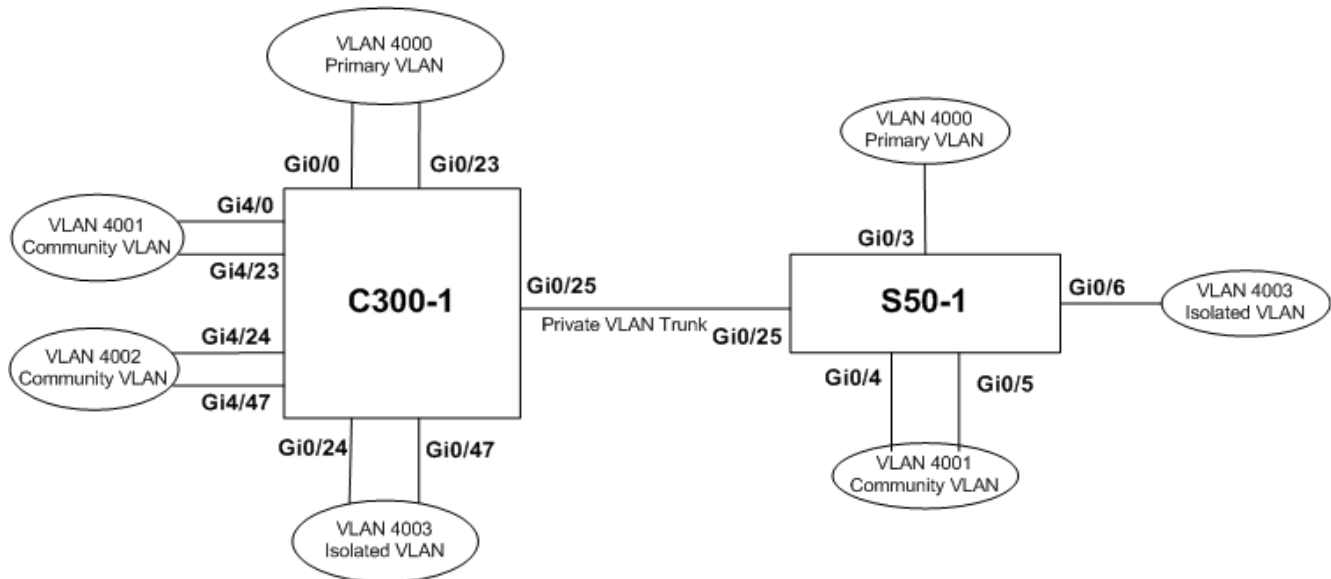

The following configuration is based on the example diagram, above:

On C300-1:

- Gi 0/0 and Gi 23 are configured as promiscuous ports, assigned to the primary VLAN, VLAN 4000.
- Gi 0/25 is configured as a PVLAN trunk port, also assigned to the primary VLAN 4000.
- Gi 0/24 and Gi 0/47 are configured as host ports and assigned to the isolated VLAN, VLAN 4003.
- Gi 4/0 and Gi 23 are configured as host ports and assigned to the community VLAN, VLAN 4001.
- Gi 4/24 and Gi 4/47 are configured as host ports and assigned to community VLAN 4002.

The result is that:

- The ports in community VLAN 4001 can communicate directly with each other and with promiscuous ports.
- The ports in community VLAN 4002 can communicate directly with each other and with promiscuous ports
- The ports in isolated VLAN 4003 can only communicate with the promiscuous ports in the primary VLAN 4000.
- All the ports in the secondary VLANs (both community and isolated VLANs) can only communicate with ports in the other secondary VLANs of that PVLAN over Layer 3, and only when the command `ip local-proxy-arp` is invoked in the primary VLAN.



Note: Even after `ip-local-proxy-arp` is disabled (no `ip-local-proxy-arp`) in a secondary VLAN, Layer 3 communication may happen between some secondary VLAN hosts, until the ARP timeout happens on those secondary VLAN hosts.

In parallel, on S50-1:

- Gi 0/3 is a promiscuous port and Gi 0/25 is a PVLAN trunk port, assigned to the primary VLAN 4000.
- Gi 0/4-6 are host ports. Gi 0/4 and Gi 0/5 are assigned to the community VLAN 4001, while Gi 0/6 is assigned to the isolated VLAN 4003.

The result is that:

- The S50V ports would have the same intra-switch communication characteristics as described above for the C300.
- For transmission between switches, tagged packets originating from host PVLAN ports in one secondary VLAN and destined for host PVLAN ports in the other switch travel through the promiscuous ports in the local VLAN 4000 and then through the trunk ports (0/25 in each switch).

Inspecting the Private VLAN Configuration

The standard methods of inspecting configurations also apply in PVLANS:

- Within the `INTERFACE` and `INTERFACE VLAN` modes, use the **show config** command to display the specific interface configuration.
- Inspect the running-config, and, with the `grep` pipe option (**show running-config | grep string**), you can display a specific part of the running-config. [Figure 36-8](#) shows the PVLAN parts of the running-config from the S50V switch in the topology diagram shown in [Figure 36-3](#), above.
- You can also use one of three **show** commands that are specific to the Private VLAN feature:
 - **show interfaces private-vlan [interface interface]**: Display the type and status of the configured PVLAN interfaces. See the example output in the Security chapter of the *FTOS Command Line Reference*.
 - **show vlan private-vlan [community | interface | isolated | primary | primary_vlan | interface interface]**: Display the configured PVLANS or interfaces that are part of a PVLAN. [Figure 36-4](#) shows the results of using the command without command options on the C300 switch in the topology diagram shown in [Figure 36-3](#), above, while [Figure 36-5](#) shows the results on the S50V.

- **show vlan private-vlan mapping:** Display the primary-secondary VLAN mapping. See the example output from the S50V, above, in [Figure 36-6](#).
- Two **show** commands revised to display PVLAN data are:
 - **show arp**
 - **show vlan:** See revised output in [Figure 36-7](#).

Figure 36-4. show vlan private-vlan Example Output from C300

```
c300-1#show vlan private-vlan

Primary Secondary Type      Active Ports
-----
4000                Primary  Yes   Gi 0/0,23,25
      4001          Community Yes   Gi 4/0,23
      4002          Community Yes   Gi 4/24,47
      4003          Isolated Yes   Gi 0/24,47
```

Figure 36-5. show vlan private-vlan Example Output from S50V

```
S50-1#show vlan private-vlan

Primary Secondary Type      Active Ports
-----
4000                Primary  Yes   Gi 0/3,25
      4001          Community Yes   Gi 0/4-5
      4003          Isolated Yes   Gi 0/6
```

Figure 36-6. show vlan private-vlan mapping Example Output from S50V

```
S50-1#show vlan private-vlan mapping
Private Vlan:
Primary   : 4000
Isolated  : 4003
Community : 4001
```

In the following screenshot, note the addition of the PVLAN codes – P, I, and C – in the left column:

Figure 36-7. show vlan Example Output from S50V

```
S50V#show vlan

Codes: * - Default VLAN, G - GVRP VLANs, P - Primary, C - Community, I - Isolated
Q: U - Untagged, T - Tagged
   x - Dot1x untagged, X - Dot1x tagged
   G - GVRP tagged, M - Vlan-stack

  NUM   Status   Description                               Q Ports
*   1     Inactive
  100   Inactive
P   200   Inactive  primary VLAN in PVLAN                     T Gi 0/19-20
I   201   Inactive  isolated VLAN in VLAN 200                 T Gi 0/21
```

PVLAN codes

Figure 36-8. Example running-config Output of PVLAN Configuration from S50V

```
!  
interface GigabitEthernet 0/3  
  no ip address  
  switchport  
  switchport mode private-vlan promiscuous  
  no shutdown  
!  
interface GigabitEthernet 0/4  
  no ip address  
  switchport  
  switchport mode private-vlan host  
  no shutdown  
!  
interface GigabitEthernet 0/5  
  no ip address  
  switchport  
  switchport mode private-vlan host  
  no shutdown  
!  
interface GigabitEthernet 0/6  
  no ip address  
  switchport  
  switchport mode private-vlan host  
  no shutdown  
!  
interface GigabitEthernet 0/25  
  no ip address  
  switchport  
  switchport mode private-vlan trunk  
  no shutdown  
!  
interface Vlan 4000  
  private-vlan mode primary  
  private-vlan mapping secondary-vlan 4001-4003  
  no ip address  
  tagged GigabitEthernet 0/3,25  
  no shutdown  
!  
interface Vlan 4001  
  private-vlan mode community
```

Per-VLAN Spanning Tree Plus (PVST+)

Per-VLAN Spanning Tree Plus (PVST+) is supported on platforms: **e c s** **S4810**

S4820T

Protocol Overview

Per-VLAN Spanning Tree Plus (PVST+) is a variation of Spanning Tree—developed by a third party—that allows you to configure a separate Spanning Tree instance for each VLAN. For more information on Spanning Tree, see [Chapter 48, Spanning Tree Protocol \(STP\)](#).

Figure 37-1. Per-VLAN Spanning Tree

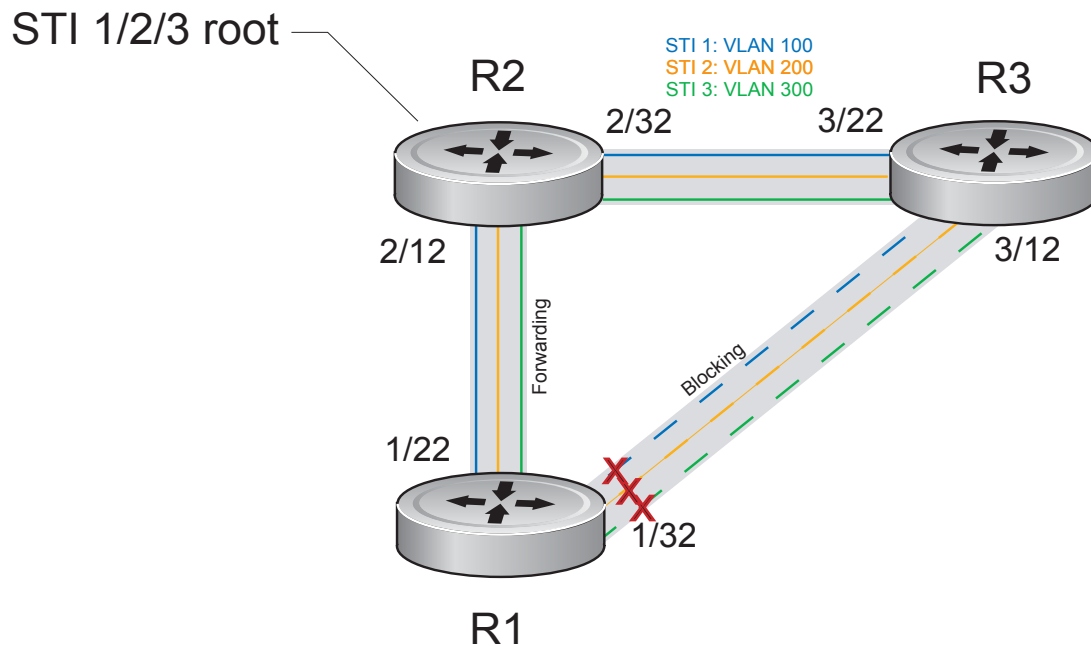

FTOS supports three other variations of Spanning Tree, as shown in [Table 37-1](#).

Table 37-1. FTOS Supported Spanning Tree Protocols

| Dell Force10 Term | IEEE Specification |
|--|--------------------|
| Spanning Tree Protocol (STP) | 802.1d |
| Rapid Spanning Tree Protocol (RSTP) | 802.1w |
| Multiple Spanning Tree Protocol (MSTP) | 802.1s |
| Per-VLAN Spanning Tree Plus (PVST+) | Third Party |

Implementation Information

- The FTOS implementation of PVST+ is based on IEEE Standard 802.1d.
- The FTOS implementation of PVST+ uses IEEE 802.1s costs as the default costs ([Table 37-2](#)). Other implementations use IEEE 802.1d costs as the default costs if you are using Dell Force10 systems in a multi-vendor network, verify that the costs are values you intended.
- You must allocate at least the default minimum amount of Layer 2 ACL CAM space when employing PVST+ on the E-Series. See [Configure Ingress Layer 2 ACL Sub-partitions on page 276](#).
- On the C-Series and S-Series, you can enable PVST+ on 254 VLANs. To set up VLANs, see [Chapter 52, Virtual LANs \(VLAN\)](#).

Configure Per-VLAN Spanning Tree Plus

Configuring PVST+ is a four-step process:

1. Configure interfaces for Layer 2.
2. Place the interfaces in VLANs.
3. Enable PVST+. See [page 747](#).
4. Optionally, for load balancing, select a non-default bridge-priority for a VLAN. See [page 747](#).

Related Configuration Tasks

- [Modify Global PVST+ Parameters on page 749](#)
- [Modify Interface PVST+ Parameters on page 750](#)
- [Configure an EdgePort on page 751](#)
- [Flush MAC Addresses after a Topology Change on page 667](#)
- [Preventing Network Disruptions with BPDU Guard on page 953](#)
- [SNMP Traps for Root Elections and Topology Changes on page 958](#)

- [Configuring Spanning Trees as Hitless on page 959](#)
- [PVST+ in Multi-vendor Networks on page 752](#)
- [PVST+ Extended System ID on page 752](#)
- [PVST+ Sample Configurations on page 753](#)

Enable PVST+

When you enable PVST+, FTOS instantiates STP on each active VLAN. To enable PVST+ globally:

| Step | Task | Command Syntax | Command Mode |
|------|---------------------|-----------------------------|---------------|
| 1 | Enter PVST context. | protocol spanning-tree pvst | PROTOCOL PVST |
| 2 | Enable PVST+. | no disable | PROTOCOL PVST |

Disable PVST+

| Task | Command Syntax | Command Mode |
|---|-----------------------|---------------|
| Disable PVST+ globally. | disable | PROTOCOL PVST |
| Disable PVST+ on an interface, or remove a PVST+ parameter configuration. | no spanning-tree pvst | INTERFACE |

Display your PVST+ configuration by entering the command `show config` from PROTOCOL PVST context, as shown in fig.

Figure 37-2. Display the PVST+ Configuration

```
FTOS_E600(conf-pvst)#show config verbose
!
protocol spanning-tree pvst
  no disable
  vlan 100 bridge-priority 4096
```

Influence PVST+ Root Selection

In [Figure 37-1](#), all VLANs use the same forwarding topology because R2 is elected the root, and all GigabitEthernet ports have the same cost. [Figure 37-3](#) changes the bridge priority of each bridge so that a different forwarding topology is generated for each VLAN. This behavior demonstrates how you can use PVST+ to achieve load balancing.

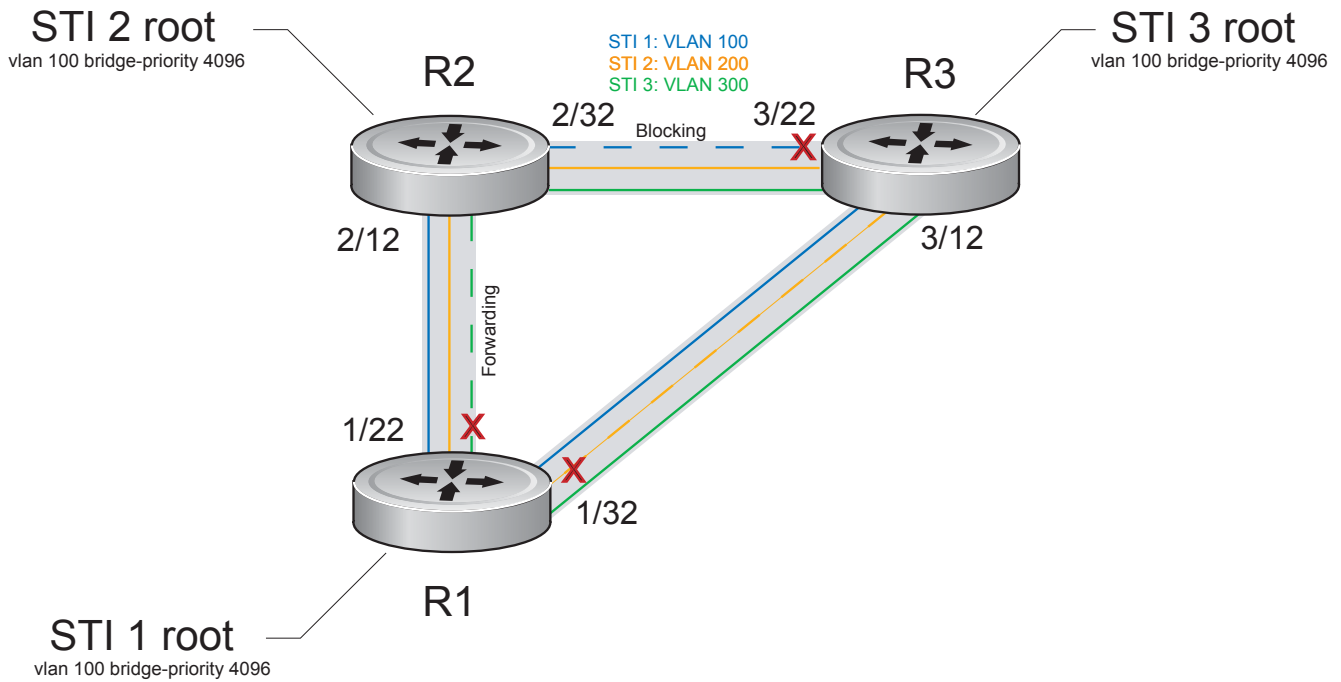
Figure 37-3. Load Balancing with PVST+

The bridge with the bridge value for bridge priority is elected root. Since all bridges use the default priority (until configured otherwise), lowest MAC address is used as a tie-breaker. Assign bridges a low non-default value for bridge priority to increase the likelihood that it will be selected as the STP root.

| Task | Command Syntax | Command Mode |
|--|----------------------|---------------|
| Assign a bridge priority. Range: 0 to 61440 Default: 32768 | vlan bridge-priority | PROTOCOL PVST |

Display the PVST+ forwarding topology by entering the command `show spanning-tree pvst [vlan vlan-id]` from EXEC Privilege mode, as shown in [Figure 37-4](#).

Figure 37-4. Display the PVST+ Forwarding Topology

```
FTOS_E600(conf)#do show spanning-tree pvst vlan 100
VLAN 100
Root Identifier has priority 4096, Address 0001.e80d.b6d6
Root Bridge hello time 2, max age 20, forward delay 15
Bridge Identifier has priority 4096, Address 0001.e80d.b6d6
Configured hello time 2, max age 20, forward delay 15
We are the root of VLAN 100
Current root has priority 4096, Address 0001.e80d.b6d6
Number of topology changes 5, last change occurred 00:34:37 ago on Gi 1/32

Port 375 (GigabitEthernet 1/22) is designated Forwarding
Port path cost 20000, Port priority 128, Port Identifier 128.375
Designated root has priority 4096, address 0001.e80d.b6:d6
Designated bridge has priority 4096, address 0001.e80d.b6:d6
Designated port id is 128.375 , designated path cost 0
Number of transitions to forwarding state 2
BPDU sent 1159, received 632
The port is not in the Edge port mode

Port 385 (GigabitEthernet 1/32) is designated Forwarding
Port path cost 20000, Port priority 128, Port Identifier 128.385
Designated root has priority 4096, address 0001.e80d.b6:d6
Designated bridge has priority 4096, address 0001.e80d.b6:d6
Designated port id is 128.385 , designated path cost 0
```

Modify Global PVST+ Parameters

The root bridge sets the values for forward-delay, and hello-time and overwrites the values set on other PVST+ bridges.

- **Forward-delay** is the amount of time an interface waits in the Listening State and the Learning State before it transitions to the Forwarding State.
- **Hello-time** is the time interval in which the bridge sends Bridge Protocol Data Units (BPDUs).
- **Max-age** is the length of time the bridge maintains configuration information before it refreshes that information by recomputing the PVST+ topology.

To change PVST+ parameters, use the following commands on the root bridge:

| Task | Command Syntax | Command Mode |
|---|--------------------|---------------|
| Change the forward-delay parameter. <ul style="list-style-type: none">• Range: 4 to 30• Default: 15 seconds | vlan forward-delay | PROTOCOL PVST |
| Change the hello-time parameter. Note: With large configurations (especially those with more ports) Dell Force10 recommends that you increase the hello-time. Range: 1 to 10 Default: 2 seconds | vlan hello-time | PROTOCOL PVST |

| Task | Command Syntax | Command Mode |
|--|----------------|---------------|
| Change the max-age parameter. Range: 6 to 40 Default: 20 seconds | vlan max-age | PROTOCOL PVST |

The values for global PVST+ parameters are given in the output of the command `show spanning-tree pvst`, as shown in [Figure 37-4](#).

Modify Interface PVST+ Parameters

You can adjust two interface parameters to increase or decrease the probability that a port becomes a forwarding port:

- **Port cost** is a value that is based on the interface type. The greater the port cost, the less likely the port will be selected to be a forwarding port.
- **Port priority** influences the likelihood that a port will be selected to be a forwarding port in case that several ports have the same port cost.

[Table 37-2](#) lists the default values for port cost by interface.

Table 37-2. PVST+ Default Port Cost Values

| Port Cost | Default Value |
|--|---------------|
| 100-Mb/s Ethernet interfaces | 200000 |
| 1-Gigabit Ethernet interfaces | 20000 |
| 10-Gigabit Ethernet interfaces | 2000 |
| Port Channel with 100 Mb/s Ethernet interfaces | 180000 |
| Port Channel with 1-Gigabit Ethernet interfaces | 18000 |
| Port Channel with 10-Gigabit Ethernet interfaces | 1800 |



Note: The FTOS implementation of PVST+ uses IEEE 802.1s costs as the default costs. Other implementations use IEEE 802.1d costs as the default costs if you are using Dell Force10 systems in a multi-vendor network, verify that the costs are values you intended.

To change the port cost or priority of an interface:

| Task | Command Syntax | Command Mode |
|--|------------------------------|--------------|
| Change the port cost of an interface. Range: 0 to 200000 Default: see Table 37-2 . | spanning-tree pvst vlan cost | INTERFACE |

| Task | Command Syntax | Command Mode |
|---|----------------------------------|--------------|
| Change the port priority of an interface. Range: 0 to 240, in increments of 16 Default: 128 | spanning-tree pvst vlan priority | INTERFACE |

The values for interface PVST+ parameters are given in the output of the command `show spanning-tree pvst`, as shown in [Figure 37-4](#).

Configure an EdgePort

The EdgePort feature enables interfaces to begin forwarding traffic approximately 30 seconds sooner. In this mode an interface forwards frames by default until it receives a BPDU that indicates that it should behave otherwise; it does not go through the Learning and Listening states. The `bpduguard shutdown-on-violation` option causes the interface hardware to be shutdown when it receives a BPDU. When only `bpduguard` is implemented, although the interface is placed in an Error Disabled state when receiving the BPDU, the physical interface remains up and spanning-tree will drop packets in the hardware after a BPDU violation. BPDUs are dropped in the software after receiving the BPDU violation. This feature is the same as PortFast mode in Spanning Tree.



Caution: Configure EdgePort only on links connecting to an end station. EdgePort can cause loops if it is enabled on an interface connected to a network.

To enable EdgePort on an interface, use the following command:

| Task | Command Syntax | Command Mode |
|----------------------------------|--|--------------|
| Enable EdgePort on an interface. | spanning-tree pvst edge-port [bpduguard shutdown-on-violation] | INTERFACE |

The EdgePort status of each interface is given in the output of the command `show spanning-tree pvst`, as shown in [Figure 37-4](#).

FTOS Behavior: Regarding bpduguard shutdown-on-violation behavior:

- 1 If the interface to be shutdown is a port channel then all the member ports are disabled in the hardware.
- 2 When a physical port is added to a port channel already in error disable state, the new member port will also be disabled in the hardware.
- 3 When a physical port is removed from a port channel in error disable state, the error disabled state is cleared on this physical port (the physical port will be enabled in the hardware).
- 4 The `reset linecard` command does not clear the error disabled state of the port or the hardware disabled state. The interface continues to be disabled in the hardware.

The error disabled state can be cleared with any of the following methods:

- Perform a `shutdown` command on the interface.
- Disable the `shutdown-on-violation` command on the interface (`no spanning-tree stp-id portfast [bpduguard | [shutdown-on-violation]]`).
- Disable spanning tree on the interface (`no spanning-tree` in INTERFACE mode).
- Disabling global spanning tree (`no spanning-tree` in CONFIGURATION mode).

PVST+ in Multi-vendor Networks

Some non-Dell Force10 systems which have hybrid ports participating in PVST+ transmit two kinds of BPDUs: an 802.1D BPDU and an untagged PVST+ BPDU.

Dell Force10 systems do not expect PVST+ BPDU (tagged or untagged) on an untagged port. If this happens, FTOS places the port in error-disable state. This behavior might result in the network not converging. To prevent FTOS from executing this action, use the command `no spanning-tree pvst err-disable cause invalid-pvst-bpdu`. After you configure this command, if the port receives a PVST+ BPDU, the BPDU is dropped, and the port remains operational.

PVST+ Extended System ID

In [Figure 37-5](#), ports P1 and P2 are untagged members of different VLANs. These ports are untagged because the hub is VLAN unaware. There is no data loop in the above scenario, however, PVST+ can be employed to avoid potential misconfigurations.

If PVST+ is enabled on the Dell Force10 switch in this network, P1 and P2 receive BPDUs from each other. Ordinarily, the Bridge ID in the frame matches the Root ID, a loop is detected, and the rules of convergence require that P2 move to blocking state because it has the lowest port ID.

To keep both ports in forwarding state, use Extend System ID. Extend System ID augments the Bridge ID with a VLAN ID to differentiate BPDUs on each VLAN so that PVST+ does not detect a loop, and both ports can remain in forwarding state.

Figure 37-5. PVST+ with Extend System ID

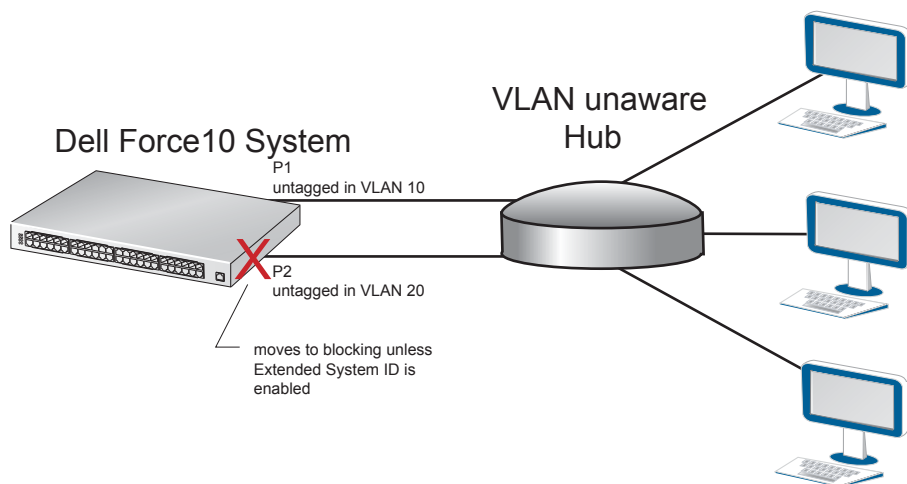

| Task | Command Syntax | Command Mode |
|---|-------------------------------|---------------|
| Augment the Bridge ID with the VLAN ID. | <code>extend system-id</code> | PROTOCOL PVST |

```

FTOS(conf-pvst)#do show spanning-tree pvst vlan 5 brief

VLAN 5
Executing IEEE compatible Spanning Tree Protocol
Root ID    Priority 32773, Address 0001.e832.73f7
Root Bridge hello time 2, max age 20, forward delay 15
Bridge ID  Priority 32773 (priority 32768 sys-id-ext 5), Address 0001.e832.73f7
We are the root of Vlan 5
Configured hello time 2, max age 20, forward delay 15
...

```

PVST+ Sample Configurations

Figure 37-6, Figure 37-7, and Figure 37-8 provide the running configurations for the topology shown in Figure 37-3.

Figure 37-6. PVST+ Sample Configuration: R1 Running-configuration

```
interface GigabitEthernet 1/22
  no ip address
  switchport
  no shutdown
!
interface GigabitEthernet 1/32
  no ip address
  switchport
  no shutdown
!
protocol spanning-tree pvst
  no disable
  vlan 100 bridge-priority 4096
interface Vlan 100
  no ip address
  tagged GigabitEthernet 1/22,32
  no shutdown
!
interface Vlan 200
  no ip address
  tagged GigabitEthernet 1/22,32
  no shutdown
!
interface Vlan 300
  no ip address
  tagged GigabitEthernet 1/22,32
  no shutdown
!
protocol spanning-tree pvst
  no disable
  vlan 100 bridge-priority 4096
```

Figure 37-7. PVST+ Sample Configuration: R2 Running-configuration

```
interface GigabitEthernet 2/12
no ip address
switchport
no shutdown
!
interface GigabitEthernet 2/32
no ip address
switchport
no shutdown
!
interface Vlan 100
no ip address
tagged GigabitEthernet 2/12,32
no shutdown
!
interface Vlan 200
no ip address
tagged GigabitEthernet 2/12,32
no shutdown
!
interface Vlan 300
no ip address
tagged GigabitEthernet 2/12,32
no shutdown
!
protocol spanning-tree pvst
no disable
vlan 200 bridge-priority 4096
```

Figure 37-8. PVST+ Sample Configuration: R3 Running-configuration

```
interface GigabitEthernet 3/12
no ip address
switchport
no shutdown
!
interface GigabitEthernet 3/22
no ip address
switchport
no shutdown
!
interface Vlan 100
no ip address
tagged GigabitEthernet 3/12,22
no shutdown
!
interface Vlan 200
no ip address
tagged GigabitEthernet 3/12,22
no shutdown
!
interface Vlan 300
no ip address
tagged GigabitEthernet 3/12,22
no shutdown
!
protocol spanning-tree pvst
no disable
vlan 300 bridge-priority 4096
```

Quality of Service (QoS)

Quality of Service (QoS) is supported on platforms: e C S **S4810** **S4820T**

Differentiated service is accomplished by classifying and queuing traffic, and assigning priorities to those queues.

The E-Series has eight unicast queues per port and 128 multicast queues per-port pipe. Traffic is queued on ingress and egress. By default, on ingress, all data traffic is mapped to Queue 0, and all control traffic is mapped to Queue 7. On egress control traffic is mapped across all eight queues. All queues are serviced using the Weighted Fair Queuing scheduling algorithm. You can only manage queuing prioritization on egress.

The C-Series traffic has eight queues per port. Four queues are for data traffic and four are for control traffic. All queues are serviced using the Deficit Round Robin scheduling algorithm. You can only manage queuing prioritization on egress.

Table 38-1. FTOS Support for Port-based, Policy-based, and Multicast QoS Features

| Feature | Platform | Direction |
|--|----------|------------------|
| Port-based QoS Configurations | e C S | Ingress + Egress |
| Set dot1p Priorities for Incoming Traffic | e C S | Ingress |
| Honor dot1p Priorities on Ingress Traffic | e C S | |
| Configure Port-based Rate Policing | e C S | |
| Configure Port-based Rate Limiting | e | Egress |
| Configure Port-based Rate Shaping | e C S | |
| Policy-based QoS Configurations | e C S | Ingress + Egress |
| Classify Traffic | e C S | Ingress |
| Create a Layer 3 class map | e C S | |
| Set DSCP values for egress packets based on flow | e | |
| Create a Layer 2 class map | e C S | |
| Create a QoS Policy | e C S | Ingress + Egress |

Table 38-1. FTOS Support for Port-based, Policy-based, and Multicast QoS Features

| Feature | Platform | Direction |
|--|---------------------------------|------------------|
| Create an input QoS policy | C E S | Ingress |
| Configure policy-based rate policing | C E S | |
| Set a DSCP value for egress packets | e | |
| Set a dot1p value for egress packets | C E S | |
| Create an output QoS policy | C E S | Egress |
| Configure policy-based rate limiting | e | |
| Configure policy-based rate shaping | C E S | |
| Allocate bandwidth to queue | C E S | |
| Specify WRED drop precedence | 54810 54820T e | |
| Create Policy Maps | C E S | Ingress + Egress |
| Create Input Policy Maps | C E S | Ingress |
| Honor DSCP values on ingress packets | C E S | |
| Honoring dot1p values on ingress packets | e C S | |
| Create Output Policy Maps | C E S | Egress |
| Specify an aggregate QoS policy | C E S | |
| QoS Rate Adjustment | C E S | |
| Strict-priority Queueing | C E S | — |
| Weighted Random Early Detection | 54810 54820T e | |
| Create WRED Profiles | 54810 54820T e | |
| Pre-calculating Available QoS CAM Space | C E S | — |

Figure 38-1. Dell Force10 QoS Architecture

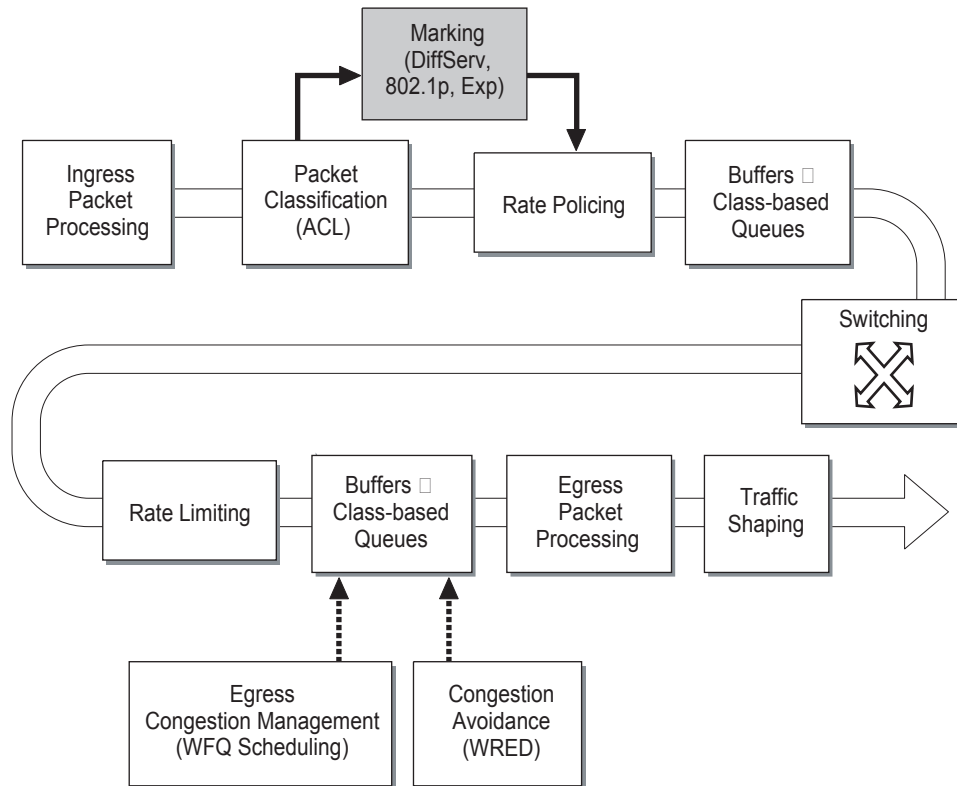

Implementation Information

The Dell Force10 QoS implementation complies with IEEE 802.1p *User Priority Bits for QoS Indication*. It also implements these Internet Engineering Task Force (IETF) documents:

- RFC 2474, *Definition of the Differentiated Services Field (DS Field) in the IPv4 Headers*
- RFC 2475, *An Architecture for Differentiated Services*
- RFC 2597, *Assured Forwarding PHB Group*
- RFC 2598, *An Expedited Forwarding PHB*

You cannot configure port-based and policy-based QoS on the same interface, and SONET line cards support only port-based QoS.

Port-based QoS Configurations

You can configure the following QoS features on an interface:



Note: Egress rate shaping and ingress rate policing cannot be simultaneously used on the same VLAN.

- [Set dot1p Priorities for Incoming Traffic](#)
- [Configure Port-based Rate Policing](#)
- [Configure Port-based Rate Limiting](#)
- [Configure Port-based Rate Shaping](#)

Set dot1p Priorities for Incoming Traffic

Change the priority of incoming traffic on the interface using the command `dot1p-priority` from INTERFACE mode, as shown in [Figure 38-2](#). FTOS places traffic marked with a priority in a queue based on [Table 38-2](#). If you set a dot1p priority for a port-channel, all port-channel members are configured with the same value. You cannot assign a dot1p value to an individual interfaces in a port-channel.

FTOS Behavior: The C-Series and S-Series distribute eight dot1p priorities across four data queues. This is different from the E-Series, which distributes eight dot1p priorities across eight queues ([Table 38-2](#)).

Table 38-2. dot1p-priority values and queue numbers

| dot1p | E-Series Queue Number | C-Series Queue Number | S-Series Queue Number |
|-------|-----------------------|-----------------------|-----------------------|
| 0 | 2 | 1 | 1 |
| 1 | 0 | 0 | 0 |
| 2 | 1 | 0 | 0 |
| 3 | 3 | 1 | 1 |
| 4 | 4 | 2 | 2 |
| 5 | 5 | 2 | 2 |
| 6 | 6 | 3 | 3 |
| 7 | 7 | 3 | 3 |

Figure 38-2. Configuring dot1p Priority on an Interface

```
FTOS#config
FTOS(conf)#interface gigabitethernet 1/0
FTOS(conf-if)#switchport
FTOS(conf-if)#dot1p-priority 1
FTOS(conf-if)#end
FTOS#
```

Honor dot1p Priorities on Ingress Traffic

By default FTOS does not honor dot1p priorities on ingress traffic. Use the command `service-class dynamic dot1p` from INTERFACE mode to honor dot1p priorities on ingress traffic, as shown in [Figure 38-3](#). You can configure this feature on physical interfaces and port-channels, but you cannot configure it on individual interfaces in a port channel.

On the C-Series and S-Series you can configure `service-class dynamic dot1p` from CONFIGURATION mode, which applies the configuration to all interfaces. A CONFIGURATION mode `service-class dynamic dot1p` entry supersedes any INTERFACE entries. See [Mapping dot1p values to service queues on page 774](#).



Note: You cannot configure `service-policy input` and `service-class dynamic dot1p` on the same interface.

Figure 38-3. service-class dynamic dot1p Command Example

```
FTOS#config t
FTOS(conf)#interface gigabitethernet 1/0
FTOS(conf-if)#service-class dynamic dot1p
FTOS(conf-if)#end
FTOS#
```

Priority-tagged Frames on the Default VLAN

[Priority-tagged Frames on the Default VLAN](#) is available only on platforms: **E X C S**

Priority-tagged frames are 802.1Q tagged frames with VLAN ID 0. For VLAN classification these packets are treated as untagged. However, the `dot1p` value is still honored when `service-class dynamic dot1p` or `trust dot1p` is configured.

When priority-tagged frames ingress an untagged port or hybrid port the frames are classified to the default VLAN of the port, and to a queue according to their `dot1p` priority `dot1p` priority if `service-class dynamic dot1p` or `trust dot1p` are configured. When priority-tagged frames ingress a tagged port, the frames are dropped because for a tagged port the default VLAN is 0.

FTOS Behavior: Hybrid ports can receive untagged, tagged, and priority tagged frames. The rate metering calculation might be inaccurate for untagged ports, since an internal assumption is made that all frames are treated as tagged. Internally the ASIC adds a 4-bytes tag to received untagged frames. Though these 4-bytes are not part of the untagged frame received on the wire, they are included in the rate metering calculation resulting in metering inaccuracy.

Configure Port-based Rate Policing

Rate policing ingress traffic on an interface using the command `rate police` from INTERFACE mode, as shown in [Figure 38-4](#). If the interface is a member of a VLAN, you may specify the VLAN for which ingress packets are policed.

Figure 38-4. Rate Policing Ingress Traffic

```
FTOS#config t
FTOS(conf)#interface gigabitethernet 1/0
FTOS(conf-if)#rate police 100 40 peak 150 50
FTOS(conf-if)#end
FTOS#
```

Figure 38-5. Displaying your Rate Policing Configuration

```

FTOS#show interfaces gigabitEthernet 1/2 rate police
Rate police 300 (50) peak 800 (50)
  Traffic Monitor 0: normal 300 (50) peak 800 (50)
    Out of profile yellow 23386960 red 320605113
  Traffic Monitor 1: normal NA peak NA
    Out of profile yellow 0 red 0
  Traffic Monitor 2: normal NA peak NA
    Out of profile yellow 0 red 0
  Traffic Monitor 3: normal NA peak NA
    Out of profile yellow 0 red 0
  Traffic Monitor 4: normal NA peak NA
    Out of profile yellow 0 red 0

```

Configure Port-based Rate Limiting

[Configure Port-based Rate Limiting](#) is supported only on platform 

FTOS Behavior: On the C-Series and S-Series, rate shaping is effectively rate limiting because of its smaller buffer size.

Rate limit egress traffic on an interface using the command `rate limit` from INTERFACE mode, as shown in [Figure 38-6](#). If the interface is a member of a VLAN, you may specify the VLAN for which egress packets are rate limited.

Figure 38-6. Rate Limiting Egress Traffic

```

FTOS#config t
FTOS(conf)#interface gigabitEthernet 1/0
FTOS(conf-if)#rate limit 100 40 peak 150 50
FTOS(conf-if)#end
FTOS#

```

Display how your rate limiting configuration affects traffic using the keyword `rate limit` with the command `show interfaces`, as shown in [Figure 38-7](#).

Figure 38-7. Displaying How Your Rate Limiting Configuration Affects Traffic

```
FTOS#show interfaces gigabitEthernet 1/1 rate limit
Rate limit 300 (50) peak 800 (50)
  Traffic Monitor 0: normal 300 (50) peak 800 (50)
    Out of profile yellow 23386960 red 320605113
  Traffic Monitor 1: normal NA peak NA
    Out of profile yellow 0 red 0
  Traffic Monitor 2: normal NA peak NA
    Out of profile yellow 0 red 0
  Traffic Monitor 3: normal NA peak NA
    Out of profile yellow 0 red 0
  Traffic Monitor 4: normal NA peak NA
    Out of profile yellow 0 red 0
  Traffic Monitor 5: normal NA peak NA
    Out of profile yellow 0 red 0
  Traffic Monitor 6: normal NA peak NA
    Out of profile yellow 0 red 0
  Traffic Monitor 7: normal NA peak NA
    Out of profile yellow 0 red 0
Total: yellow 23386960 red 320605113
```

Configure Port-based Rate Shaping

Configure Port-based Rate Limiting is supported only on platform **C e S**

FTOS Behavior: On the C-Series and S-Series, rate shaping is effectively rate limiting because of its smaller buffer size. On the S4810 and the S4820T, rate shaping on tagged ports is slightly greater than the configured rate and rate shaping on untagged ports is slightly less than configured rate.

Rate shaping buffers, rather than drops, traffic exceeding the specified rate until the buffer is exhausted. If any stream exceeds the configured bandwidth on a continuous basis, it can consume all of the buffer space that is allocated to the port.

- Apply rate shaping to outgoing traffic on a port using the command `rate shape` from **INTERFACE** mode, as shown in [Figure 38-8](#).
- Apply rate shaping to a queue using the command `rate-shape` from **QoS Policy** mode.

Figure 38-8. Applying Rate Shaping to Outgoing Traffic

```
FTOS#config
FTOS(conf)#interface gigabitEthernet 1/0
FTOS(conf-if)#rate shape 500 50
FTOS(conf-if)#end
FTOS#
```

Policy-based QoS Configurations

Policy-based QoS configurations consist of the components shown in [Figure 38-9](#).

Figure 38-9. Constructing Policy-based QoS Configurations

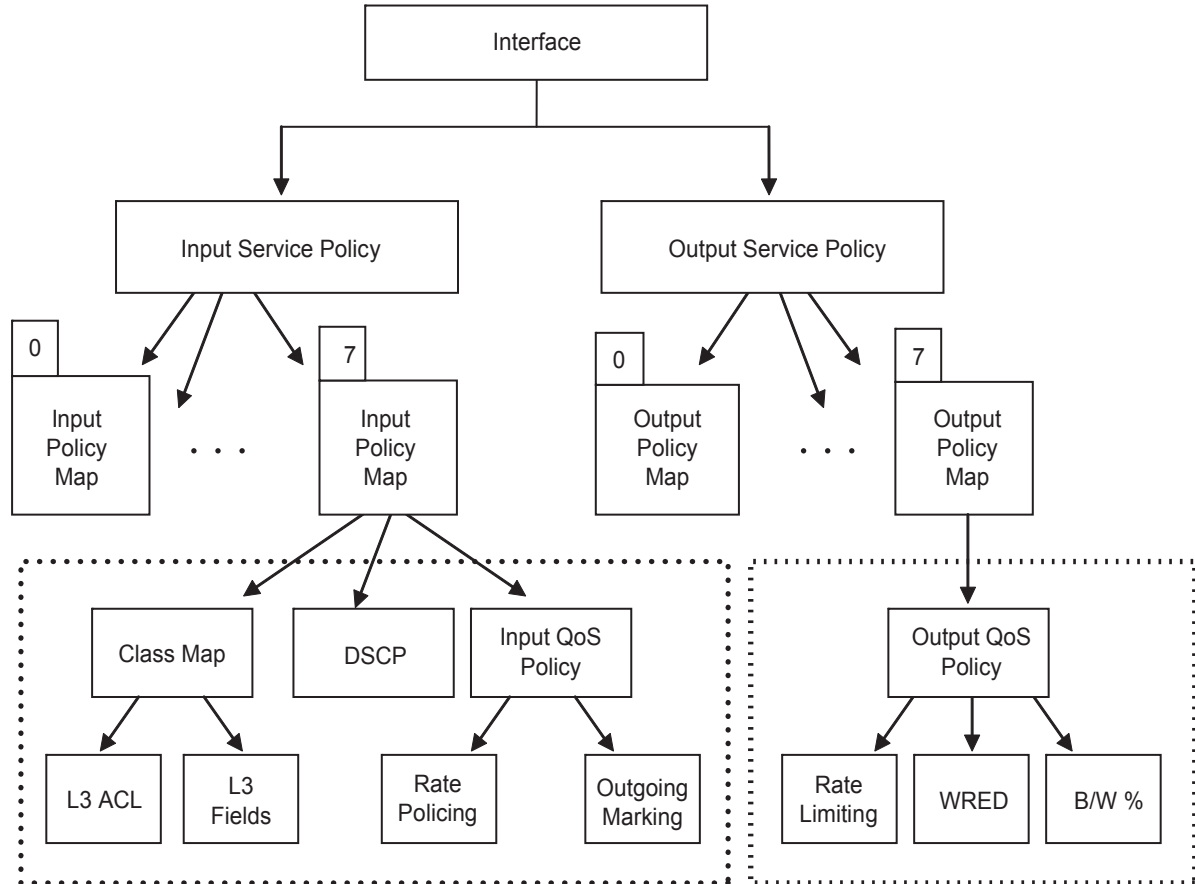

Classify Traffic

Class maps differentiate traffic so that you can apply separate quality of service policies to each class. For both class maps, Layer 2 and Layer 3, FTOS matches packets against match criteria in the order that you configure them.

Create a Layer 3 class map

A Layer 3 class map differentiates ingress packets based on DSCP value or IP precedence, and characteristics defined in an IP ACL. You may specify more than one DSCP and IP precedence value, but only one value must match to trigger a positive match for the class map.

1. Create a match-any class map using the command `class-map match-any` or a match-all class map using the command `class-map match-all` from CONFIGURATION mode, as shown in [Figure 38-10](#).

2. Once you create a class-map, FTOS places you in CLASS MAP mode. From this mode, specify your match criteria using the command `match ip`, as shown in [Figure 38-10](#). Match-any class maps allow up to five ACLs, and match-all class-maps allow only one ACL.
3. After you specify your match criteria, link the class-map to a queue using the command `service-queue` from POLICY MAP mode, as shown in [Figure 38-10](#).

Figure 38-10. Using the Order Keyword in ACLs

```

FTOS(conf)#ip access-list standard acl1
FTOS(config-std-nacl)#permit 20.0.0.0/8
FTOS(config-std-nacl)#exit
FTOS(conf)#ip access-list standard acl2
FTOS(config-std-nacl)#permit 20.1.1.0/24 order 0
FTOS(config-std-nacl)#exit
FTOS(conf)#class-map match-all cmap1
FTOS(conf-class-map)#match ip access-group acl1
FTOS(conf-class-map)#exit
FTOS(conf)#class-map match-all cmap2
FTOS(conf-class-map)#match ip access-group acl2
FTOS(conf-class-map)#exit
FTOS(conf)#policy-map-input pmap
FTOS(conf-policy-map-in)#service-queue 7 class-map cmap1
FTOS(conf-policy-map-in)#service-queue 4 class-map cmap2
FTOS(conf-policy-map-in)#exit
FTOS(conf)#interface gig 1/0
FTOS(conf-if-gi-1/0)#service-policy input pmap

```

Create a Layer 2 class map

All class maps are Layer 3 by default; you can create a Layer 2 class map by specifying the option `layer2` with the `class-map` command. A Layer 2 class map differentiates traffic according to 802.1p value and/or characteristics defined in a MAC ACL.

1. Create a match-any class map using the command `class-map match-any` or a match-all class map using the command `class-map match-all` from CONFIGURATION mode, and enter the keyword `layer2`.
2. Once you create a class-map, FTOS places you in CLASS MAP mode. From this mode, specify your match criteria using the command `match mac`. Match-any class maps allow up to five access-lists, and match-all class-maps allow only one. You can match against only one VLAN ID.
3. After you specify your match criteria, link the class-map to a queue using the command `service-queue` from POLICY MAP mode.

Determine the order in which ACLs are used to classify traffic

When you link class-maps to queues using the command `service-queue`, FTOS matches the class-maps according to queue priority (queue numbers closer to 0 have lower priorities). For example, in [Figure 38-10](#), class-map `cmap2` is matched against ingress packets before `cmap1`.

ACLs `acl1` and `acl2` have overlapping rules because the address range `20.1.1.0/24` is within `20.0.0.0/8`. Therefore, (without the keyword `order`) packets within the range `20.1.1.0/24` match positive against `cmap1` and are buffered in queue 7, though you intended for these packets to match positive against `cmap2` and be buffered in queue 4.

In cases such as these, where class-maps with overlapping ACL rules are applied to different queues, use the order keyword to specify the order in which you want to apply ACL rules, as shown in [Figure 38-10](#). The order can range from 0 to 254. FTOS writes to the CAM ACL rules with lower order numbers (order numbers closer to 0) before rules with higher order numbers so that packets are matched as you intended. By default, all ACL rules have an order of 254.

Set DSCP values for egress packets based on flow

[Set DSCP values for egress packets based on flow](#) is supported only on platform [E](#)

Match-any Layer 3 flows may have several match criteria. All flows that match at least one of the match criteria are mapped to the same queue since they are in the same class map. Setting a DSCP value from QOS-POLICY-IN mode (see [Set a DSCP value for egress packets on page 768](#)) assigns the *same* DSCP value to all of the matching flows in the class-map. The Flow-based DSCP Marking feature allows you to assign *different* DSCP to each match criteria CLASS-MAP mode using the option set-ip-dscp with the match command so that matching flows within a class map can have *different* DSCP values, as shown in [Figure 38-11](#). The values you set from CLASS-MAP mode override the value you QoS input policy DSCP value, and packets matching the rule are marked with the specified value.

Figure 38-11. Marking Flows in the Same Queue with Different DSCP Values

```
FTOS#show run class-map
!
class-map match-any example-flowbased-dscp
 match ip access-group test set-ip-dscp 2
 match ip access-group test1 set-ip-dscp 4
 match ip precedence 7 set-ip-dscp 1

FTOS#show run qos-policy-input
!
qos-policy-input flowbased
 set ip-dscp 3

FTOS# show cam layer3 linecard 2 port-set 0
Cam  Port Dscp Proto Tcp  Src  Dst  SrcIp          DstIp          DSCP  Queue
Index                               Flag Port  Port           Marking
-----
16260 1      0   TCP   0x0  0    0    1.1.1.0/24     0.0.0.0/0      2     0
16261 1      0   UDP   0x0  0    0    2.2.2.2/32     0.0.0.0/0      4     0
16262 1     56   0     0x0  0    0    0.0.0.0/0     0.0.0.0/0      1     0
24451 1      0   0     0x0  0    0    0.0.0.0/0     0.0.0.0/0     -     0
```

Display configured class maps and match criteria

Display all class-maps or a specific class map using the command `show qos class-map` from EXEC Privilege mode.

FTOS Behavior: An explicit “deny any” rule in a Layer 3 ACL used in a (match any or match all) class-map creates a “default to Queue 0” entry in the CAM, which causes unintended traffic classification. Below, traffic is classified in two Queues, 1 and 2. Class-map ClassAF1 is “match any,” and ClassAF2 is “match all”.

```
FTOS#show running-config policy-map-input
!
policy-map-input PolicyMapIn
  service-queue 1 class-map ClassAF1 qos-policy QosPolicyIn-1
  service-queue 2 class-map ClassAF2 qos-policy QosPolicyIn-2
FTOS#show running-config class-map
!
class-map match-any ClassAF1
  match ip access-group AF1-FB1 set-ip-dscp 10
  match ip access-group AF1-FB2 set-ip-dscp 12
  match ip dscp 10 set-ip-dscp 14
!
class-map match-all ClassAF2
  match ip access-group AF2
  match ip dscp 18
FTOS#show running-config ACL
!
ip access-list extended AF1-FB1
  seq 5 permit ip host 23.64.0.2 any
  seq 10 deny ip any any
!
ip access-list extended AF1-FB2
  seq 5 permit ip host 23.64.0.3 any
  seq 10 deny ip any any
!
ip access-list extended AF2
  seq 5 permit ip host 23.64.0.5 any
  seq 10 deny ip any any
```

```
FTOS#show cam layer3-qos interface gigabitethernet 4/49
```

| Cam Index | Port | Dscp | Proto | Tcp Flag | Src Port | Dst Port | SrcIp | DstIp | DSCP Marking | Queue |
|-----------|------|------|-------|----------|----------|----------|--------------|-----------|--------------|-------|
| 20416 | 1 | 18 | IP | 0x0 | 0 | 0 | 23.64.0.5/32 | 0.0.0.0/0 | 20 | 2 |
| 20417 | 1 | 18 | IP | 0x0 | 0 | 0 | 0.0.0.0/0 | 0.0.0.0/0 | - | 0 |
| 20418 | 1 | 0 | IP | 0x0 | 0 | 0 | 23.64.0.2/32 | 0.0.0.0/0 | 10 | 1 |
| 20419 | 1 | 0 | IP | 0x0 | 0 | 0 | 0.0.0.0/0 | 0.0.0.0/0 | - | 0 |
| 20420 | 1 | 0 | IP | 0x0 | 0 | 0 | 23.64.0.3/32 | 0.0.0.0/0 | 12 | 1 |
| 20421 | 1 | 0 | IP | 0x0 | 0 | 0 | 0.0.0.0/0 | 0.0.0.0/0 | - | 0 |
| 20422 | 1 | 10 | 0 | 0x0 | 0 | 0 | 0.0.0.0/0 | 0.0.0.0/0 | 14 | 1 |
| 24511 | 1 | 0 | 0 | 0x0 | 0 | 0 | 0.0.0.0/0 | 0.0.0.0/0 | - | 0 |

Above, the ClassAF1 does not classify traffic as intended. Traffic matching the first match criteria is classified to Queue 1, but all other traffic is classified to Queue 0 as a result of CAM entry 20419.

When the explicit “deny any” rule is removed from all three ACLs, the CAM reflects exactly the desired classification.

```
FTOS#show cam layer3-qos interface gigabitethernet 4/49
```

| Cam Index | Port | Dscp | Proto | Tcp Flag | Src Port | Dst Port | SrcIp | DstIp | DSCP Marking | Queue |
|-----------|------|------|-------|----------|----------|----------|--------------|-----------|--------------|-------|
| 20416 | 1 | 18 | IP | 0x0 | 0 | 0 | 23.64.0.5/32 | 0.0.0.0/0 | 20 | 2 |
| 20417 | 1 | 0 | IP | 0x0 | 0 | 0 | 23.64.0.2/32 | 0.0.0.0/0 | 10 | 1 |
| 20418 | 1 | 0 | IP | 0x0 | 0 | 0 | 23.64.0.3/32 | 0.0.0.0/0 | 12 | 1 |
| 20419 | 1 | 10 | 0 | 0x0 | 0 | 0 | 0.0.0.0/0 | 0.0.0.0/0 | 14 | 1 |
| 24511 | 1 | 0 | 0 | 0x0 | 0 | 0 | 0.0.0.0/0 | 0.0.0.0/0 | - | 0 |

Create a QoS Policy

There are two types of QoS policies: input and output.

Input QoS policies regulate Layer 3 and Layer 2 ingress traffic. The regulation mechanisms for input QoS policies are rate policing and setting priority values. There are two types of input QoS policies: Layer 3 and Layer 2.

- Layer 3 QoS input policies allow you to rate police and set a DSCP or dot1p value.
- Layer 2 QoS input policies allow you to rate police and set a dot1p value.

Output QoS policies regulate Layer 3 egress traffic. The regulation mechanisms for output QoS policies are rate limiting, rate shaping, and WRED.



Note: When changing a "service-queue" configuration in a QoS policy map, all QoS rules are deleted and re-added automatically to ensure that the order of the rules is maintained. As a result, the Matched Packets value shown in the "show qos statistics" command is reset.



Note: To avoid issues caused by misconfiguration, Dell Force10 recommends configuring either DCBX or Egress QoS features, but *not* both simultaneously. If both DCBX and Egress QoS are enabled at the same time, the DCBX configuration will be applied and unexpected behavior will occur on the Egress QoS.

Create an input QoS policy

To create an input QoS policy:

1. Create a Layer 3 input QoS policy using the command `qos-policy-input` from CONFIGURATION mode. Create a Layer 2 input QoS policy by specifying the keyword `layer2` after the command `qos-policy-input`.
2. Once you create an input QoS policy, do one or more of the following:
 - [Configure policy-based rate policing](#)
 - [Set a DSCP value for egress packets](#)
 - [Set a dot1p value for egress packets](#)

Configure policy-based rate policing

Rate police ingress traffic using the command `rate-police` from QOS-POLICY-IN mode.

Set a DSCP value for egress packets

[Set a DSCP value for egress packets](#) is supported only on platform 

Set a DSCP value for egress packets based on ingress QoS classification, as shown in [Figure 38-2](#). The 6 bits that are used for DSCP are also used to identify the queue in which traffic is buffered. When you set a DSCP value, FTOS displays an informational message advising you of the queue to which you should apply the QoS policy (using the command `service-queue` from POLICY-MAP-IN mode). If you apply the QoS policy to a queue *other than* the one specified in the informational message, FTOS replaces the first 3 bits in the DSCP field with the queue ID you specified.

Figure 38-12. Marking DSCP Values for Egress Packets

```
FTOS#config
FTOS(conf)#qos-policy-input my-input-qos-policy
FTOS(conf-qos-policy-in)#set ip-dscp 34
% Info: To set the specified DSCP value 34 (100-010 b) the QoS policy must be mapped to queue
% (100 b).
FTOS(conf-qos-policy-in)#show config
!
qos-policy-input my-input-qos-policy
  set ip-dscp 34
FTOS(conf-qos-policy-in)#end

FTOS#
```

Set a dot1p value for egress packets

Set a dot1p value for egress packets using the command `set mac-dot1p` from QOS-POLICY-IN mode.

Create an output QoS policy

To create an output QoS policy:

1. Create an output QoS policy using the command `qos-policy-output` from CONFIGURATION mode.
2. Once you configure an output QoS policy, do one or more of the following
 - [Configure policy-based rate limiting](#)
 - [Configure policy-based rate shaping](#)
 - [Allocate bandwidth to queue](#)
 - [Specify WRED drop precedence](#)

Configure policy-based rate limiting

[Configure policy-based rate limiting](#) is supported only on platform **E**

Policy-based rate limiting is configured the same way as port-based rate limiting except that the command from QOS-POLICY-OUT mode is `rate-limit` rather than `rate limit` as it is in INTERFACE mode.

Configure policy-based rate shaping

Rate shape egress traffic using the command `rate-shape` from QOS-POLICY-OUT mode.

Allocate bandwidth to queue

The E-Series schedules unicast, multicast, and replication traffic for egress based on the Weighted Fair Queuing algorithm. The C-Series and S-Series schedule packets for egress based on Deficit Round Robin (DRR). These strategies both offer a guaranteed data rate.

To allocate bandwidth to queues on the C-Series and S-Series, assign each queue a weight ranging from 1 to 1024, in increments of 2ⁿ, using the command `bandwidth-weight`. [Table 38-3](#) shows the default bandwidth weights for each queue, and their equivalent percentage which is derived by dividing the bandwidth weight by the sum of all queue weights.

Table 38-3. Default Bandwidth Weights for C-Series and S-Series

| Queue | Default Weight | Equivalent Percentage |
|-------|----------------|-----------------------|
| 0 | 1 | 6.67% |
| 1 | 2 | 13.33% |
| 2 | 4 | 26.67% |
| 3 | 8 | 53.33% |

The key difference between allocating bandwidth by weight on the C-Series and S-Series and allocating bandwidth by percentage on the E-Series because you are required to choose a bandwidth weight in increments of 2ⁿ you may not be able to achieve exactly a target bandwidth allocation.

A key similarity between allocating bandwidth by percentage and allocating by weight is that assigning a weight or percentage to one queue affects the amount of bandwidth that is allocated to other queues. Therefore, whenever you are allocating bandwidth to one queue, Dell Force10 recommends that you evaluate your bandwidth requirements for all other queues as well.

[Table 38-4](#) shows an example of choosing bandwidth weights for all four queues to achieve a target bandwidth allocation.

Table 38-4. Assigning Bandwidth Weights for the C-Series and S-Series

| Queue | Weight | Equivalent Percentage | Target Allocation |
|-------|--------|-----------------------|-------------------|
| 0 | 1 | 0.44% | 1% |
| 1 | 64 | 28.44% | 25% |
| 2 | 128 | 56.89% | 60% |
| 3 | 32 | 14.22% | 14% |

Specify WRED drop precedence

Specify WRED drop precedence is supported only on platform   

Specify a WRED profile to yellow and/or green traffic using the command `wred` from QOS-POLICY-OUT mode. See [Apply a WRED profile to traffic](#).

Create Policy Maps

There are two types of policy maps: input and output.

Create Input Policy Maps

There are two types of input policy-maps: Layer 3 and Layer 2.

1. Create a Layer 3 input policy map using the command `policy-map-input` from CONFIGURATION mode. Create a Layer 2 input policy map by specifying the keyword `layer2` with the `policy-map-input` command.
2. Once you create an input policy map, do one or more of the following:
 - [Apply a class-map or input QoS policy to a queue](#)
 - [Apply an input QoS policy to an input policy map](#)
 - [Honor DSCP values on ingress packets](#)
 - [Honoring dot1p values on ingress packets](#)
3. Apply the input policy map to an interface.

FTOS Behavior: On ExaScale, FTOS cannot classify protocol traffic on a Layer 2 interface using Layer 3 policy map. The packets always take the default queue, Queue 0, and cannot be rate-policed.

Apply a class-map or input QoS policy to a queue

Assign an input QoS policy to a queue using the command `service-queue` from POLICY-MAP-IN mode.

Apply an input QoS policy to an input policy map

Apply an input QoS policy to an input policy map using the command `policy-aggregate` from POLICY-MAP-IN mode.

Honor DSCP values on ingress packets

FTOS provides the ability to honor DSCP values on ingress packets using Trust DSCP feature. Enable this feature using the command `trust dffserv` from POLICY-MAP-IN mode. [Table 38-5](#) lists the standard DSCP definitions, and indicates to which queues FTOS maps DSCP values. When Trust DSCP is configured the matched packets and matched bytes counters are not incremented in `show qos statistics`.

Table 38-5. Default DSCP to Queue Mapping

| DSCP/CP hex range (XXX) | DSCP Definition | Traditional IP Precedence | E-Series Internal Queue ID | C-Series Internal Queue ID | S-Series Internal Queue ID | DSCP/CP decimal |
|-------------------------|---------------------------|---------------------------|----------------------------|----------------------------|----------------------------|-----------------|
| 111XXX | | Network Control | 7 | 3 | 3 | 48–63 |
| 110XXX | | Internetwork Control | 6 | 3 | 3 | |
| 101XXX | EF (Expedited Forwarding) | CRITIC/ECP | 5 | 2 | 2 | 32–47 |
| 100XXX | AF4 (Assured Forwarding) | Flash Override | 4 | 2 | 2 | |
| 011XXX | AF3 | Flash | 3 | 1 | 1 | 16–31 |
| 010XXX | AF2 | Immediate | 2 | 1 | 1 | |
| 001XXX | AF1 | Priority | 1 | 0 | 0 | 0–15 |
| 000XXX | BE (Best Effort) | Best Effort | 0 | 0 | 0 | |

Honoring dot1p values on ingress packets

FTOS provides the ability to honor dot1p values on ingress packets with the Trust dot1p feature. Enable Trust dot1p using the command `trust dot1p` from POLICY-MAP-IN mode. [Table 38-6](#) specifies the queue to which the classified traffic is sent based on the dot1p value.

Table 38-6. Default dot1p to Queue Mapping

| dot1p | E-Series Queue ID | C-Series Queue ID | S-Series Queue ID |
|-------|-------------------|-------------------|-------------------|
| 0 | 2 | 1 | 1 |
| 1 | 0 | 0 | 0 |
| 2 | 1 | 0 | 0 |
| 3 | 3 | 1 | 1 |
| 4 | 4 | 2 | 2 |
| 5 | 5 | 2 | 2 |
| 6 | 6 | 3 | 3 |
| 7 | 7 | 3 | 3 |

The dot1p value is also honored for frames on the default VLAN; see [Priority-tagged Frames on the Default VLAN](#).

Fall Back to trust diffserve or dot1p

Fall Back to trust diffserve or dot1p is available only on platforms: 

When using QoS service policies with multiple class maps, you can configure FTOS to use the incoming DSCP or dot1p marking as a secondary option for packet queuing in the event that no match occurs in the class maps.

When class-maps are used, traffic is matched against each class-map sequentially from first to last. The sequence is based on the priority of the rules, as follows:

1. rules with lowest priority, or in the absence of a priority configuration,
2. rules of the next numerically higher queue

By default, if no match occurs, the packet is queued to the default queue, Queue 0.

In the following configuration, packets are classified to queues using the three class maps:

```
!
policy-map-input input-policy
  service-queue 1 class-map qos-BE1
  service-queue 3 class-map qos-AF3
  service-queue 4 class-map qos-AF4
!
class-map match-any qos-AF3
  match ip dscp 24
  match ip access-group qos-AF3-ACL
!
class-map match-any qos-AF4
  match ip dscp 32
  match ip access-group qos-AF4-ACL
!
class-map match-all qos-BE1
  match ip dscp 0
  match ip access-group qos-BE1-ACL
```

The packet classification logic for the above configuration is as follows:

1. Match packets against match-any qos-AF4. If a match exists, queue the packet as AF4 in Queue 4, and if no match exists, go to the next class map.
2. Match packets against match-any qos-AF3. If a match exists, queue the packet as AF3 in Queue 3, and if no match exists, go to the next class map.
3. Match packets against match-all qos-BE1. If a match exists, queue the packet as BE1, and if no match exists, queue the packets to the default queue, Queue 0.

You can optionally classify packets using their DSCP marking, instead of placing packets in Queue 0, if no match occurs. In the above example, if no match occurs against match-all qos-BE1, the classification logic continues:

4. Queue the packet according to the DSCP marking. The DSCP to Queue mapping will be as per the [Table 38-5](#).

The behavior is similar for trust dot1p fallback in a Layer2 input policy map; the dot1p-to-queue mapping is according to [Table 38-6](#).

To enable Fall Back to trust diffserve or dot1p:

| Task | Command Syntax | Command Mode |
|---|------------------------------------|---------------|
| Classify packets according to their DSCP value as a secondary option in case no match occurs against the configured class maps. | trust {diffserve dot1p} fallback | POLICY-MAP-IN |

Mapping dot1p values to service queues

Mapping dot1p values to service queues is available only on platforms: **C S**

On the C-Series and S-Series all traffic is by default mapped to the same queue, Queue 0. If you honor dot1p on ingress, then you can create service classes based the queueing strategy in [Table 38-6](#) using the command `service-class dynamic dot1p` from INTERFACE mode. You may apply this queueing strategy globally by entering this command from CONFIGURATION mode.

- All dot1p traffic is mapped to Queue 0 unless `service-class dynamic dot1p` is enabled on an interface or globally.
- Layer 2 or Layer 3 service policies supersede dot1p service classes.

Guaranteeing bandwidth to dot1p-based service queues

Guarantee a minimum bandwidth to queues globally from CONFIGURATION mode with the command `service-class bandwidth-weight`. The command is applied in the same way as the `bandwidth-weight` command in an output QoS policy (see [Allocate bandwidth to queue on page 770](#)). The `bandwidth-weight` command in QOS-POLICY-OUT mode supersedes the `service-class bandwidth-weight` command.

Apply an input policy map to an interface

Apply an input policy map to an interface using the command `service-policy input` from INTERFACE mode. Specify the keyword `layer2` if the policy map you are applying a Layer 2 policy map; in this case, the INTERFACE must be in switchport mode. You can apply the same policy map to multiple interfaces, and you can modify a policy map after you apply it.

- You cannot apply a class-map and QoS policies to the same interface.
- You cannot apply an input Layer 2 QoS policy on an interface you also configure with `vlan-stack access`.
- If you apply a service policy that contains an ACL to more than one interface, FTOS uses ACL optimization to conserves CAM space. The ACL Optimization behavior detects when an ACL already exists in the CAM and rather than writing it to the CAM multiple times.

Create Output Policy Maps

Create Output Policy Maps is supported only on platform  **S4810** **S4820T**

1. Create an output policy map using the command `policy-map-output` from CONFIGURATION mode.

2. Once you create an output policy map, do one or more of the following:
 - [Apply an output QoS policy to a queue](#)
 - [Specify an aggregate QoS policy](#)
 - [Apply an output policy map to an interface](#)
3. Apply the policy map to an interface. See [page 61](#).

Apply an output QoS policy to a queue

Apply an output QoS policy to queues using the command `service-queue` from INTERFACE mode.

Specify an aggregate QoS policy

Specify an aggregate QoS policy using the command `policy-aggregate` from POLICY-MAP-OUT mode.

Apply an output policy map to an interface

Apply an input policy map to an interface using the command `service-policy output` from INTERFACE mode. You can apply the same policy map to multiple interfaces, and you can modify a policy map after you apply it.

QoS Rate Adjustment

The Ethernet packet format consists of:

- Preamble: 7 bytes Preamble
- Start Frame Delimiter (SFD): 1 byte
- Destination MAC Address: 6 bytes
- Source MAC Address: 6 bytes
- Ethernet Type/Length: 2 bytes
- Payload: (variable)
- Cyclic Redundancy Check (CRC): 4 bytes
- Inter-frame Gap (IFG): (variable)

By default, while rate limiting, policing, and shaping, FTOS does not include the Preamble, SFD, or the IFG fields. These fields are overhead; only the fields from MAC Destination Address to the CRC are used for forwarding and are included in these rate metering calculations. You can optionally include overhead fields in rate metering calculations by enabling QoS Rate Adjustment.

QoS Rate Adjustment is disabled by default, and no `qos-rate-adjust` is listed in the running-configuration.

| Task | Command Syntax | Command Mode |
|---|---|---------------|
| Include a specified number of bytes of packet overhead to include in rate limiting, policing, and shaping calculations. For example, to include the Preamble and SFD, enter <code>qos-rate-adjust 8</code> . For variable length overhead fields you must know the number of bytes you want to include. | <code>qos-rate-adjust <i>overhead-bytes</i></code> Default: Disabled C-Series and S-Series Range: 1-31 E-Series Range: 1-144 | CONFIGURATION |

Strict-priority Queuing

You can assign strict-priority to one unicast queue, 1-7, using the command `strict-priority` from CONFIGURATION mode. Strict-priority means that FTOS dequeues all packets from the assigned queue before servicing any other queues.

- The strict-priority supersedes bandwidth-percentage and bandwidth-weight percentage configurations.
- A queue with strict-priority can starve other queues in the same port-pipe.
- On the E-Series, this configuration is applied to the queue on both ingress and egress.

Weighted Random Early Detection

Weighted Random Early Detection is supported only on platform \in **S4810** **S4820T**

Weighted Random Early Detection (WRED) congestion avoidance mechanism that drops packets to prevent buffering resources from being consumed.

Traffic is a mixture of various kinds of packets. The rate at which some types of packets arrive might be greater than others. In this case, the space on the BTM (ingress or egress) can be consumed by only one or a few types of traffic, leaving no space for other types. A WRED profile can be applied to a policy-map so that specified traffic can be prevented from consuming too much of the BTM resources.

WRED uses a profile to specify minimum and maximum threshold values. The minimum threshold is the allotted buffer space for specified traffic, for example 1000KB on egress. If the 1000KB is consumed, packets will be dropped randomly at an exponential rate until the maximum threshold is reached (Figure 38-13); this is the “early detection” part of WRED. If the maximum threshold—2000KB, for example—is reached, then all incoming packets are dropped until less than 2000KB of buffer space is consumed by the specified traffic.

Figure 38-13. Packet Drop Rate for WRED

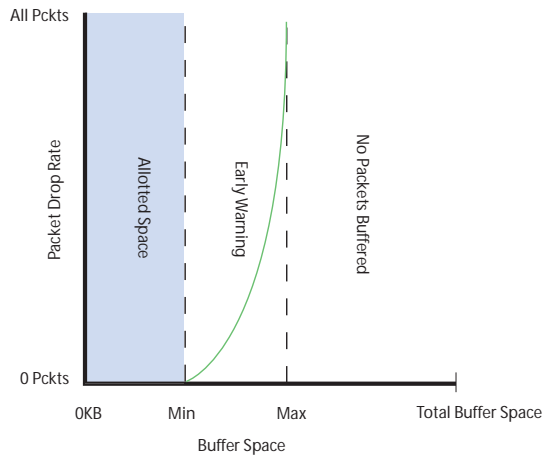

fnC0045mp

You can create a custom WRED profile or use one of the five pre-defined profiles.

Table 38-7. Pre-defined WRED Profiles (E-Series)

| Default Profile Name | Minimum Threshold | Maximum Threshold |
|----------------------|-------------------|-------------------|
| wred_drop | 0 | 0 |
| wred_ge_y | 1024 | 2048 |
| wred_ge_g | 2048 | 4096 |
| wred_teng_y | 4096 | 8192 |
| wred_teng_g | 8192 | 16384 |

Table 38-8. Pre-defined WRED Profiles (S4810 and S4820T)

| Default Profile Name | Minimum Threshold | Maximum Threshold | Maximum Drop Rate |
|----------------------|-------------------|-------------------|-------------------|
| wred_drop | 0 | 0 | 100 |
| wred_teng_y | 467 | 4671 | 100 |
| wred_teng_g | 467 | 4671 | 50 |
| wred_fortyg_y | 467 | 4671 | 50 |
| wred_fortyg_g | 467 | 4671 | 25 |

Create WRED Profiles

To create a WRED profile:

1. Create a WRED profile using the command `wred` from CONFIGURATION mode.

- The command `wred` places you in WRED mode. From this mode, specify minimum and maximum threshold values using the command `threshold`.

Apply a WRED profile to traffic

Once you create a WRED profile you must specify to which traffic FTOS should apply the profile.

FTOS assigns a color (also called drop precedence)—red, yellow, or green—to each packet based on its DSCP value before queuing it. DSCP is a 6 bit field. Dell Force10 uses the first three bits of this field (DP) to determine the drop precedence. DP values of 110 and 100 map to yellow, and all other values map to green. If you do not configure FTOS to honor DSCP values on ingress ([Honor DSCP values on ingress packets on page 771](#)) see all traffic defaults to green drop precedence.

Assign a WRED profile to either yellow or green traffic from QOS-POLICY-OUT mode using the command `wred`.

Display Default and Configured WRED Profiles

Display default and configured WRED profiles and their threshold values using the command `show qos wred-profile` from EXEC mode, as shown in [Figure 38-14](#).

Figure 38-14. Displaying WRED Profiles (E-Series)

```
FTOS#show qos wred-profile

Wred-profile-name      min-threshold  max-threshold
wred_drop              0              0
wred_ge_y              1000           2000
wred_ge_g              2000           4000
wred_teng_y            4000           8000
wred_teng_g            8000           16000
```

Figure 38-15. Displaying WRED Profiles (S4810 or S4820T)

```
FTOS#show qos wred-profile

Wred-profile-name      min-threshold  max-threshold  max-drop-rate
wred_drop              0              0              100
wred_teng_y            467            4671           100
wred_teng_g            467            4671           50
wred_fortyg_y          467            4671           50
wred_fortyg_g          467            4671           25
0
FTOS#
```

Display WRED Drop Statistics

Display the number of packets FTOS dropped by WRED Profile using the command `show qos statistics` from EXEC Privilege mode.

Figure 38-16. show qos statistics Command Example (E-Series)

```
FTOS#show qos statistics wred-profile
Interface Gi 5/11
Queue#  Drop-statistic  WRED-name      Min    Max    Dropped Pkts
-----  -
0       Green                WRED1          10    100   51623
        Yellow                WRED2          20    100   51300
        Out of Profile
1       Green                WRED1          10    100   52082
        Yellow                WRED2          20    100   51004
        Out of Profile
2       Green                WRED1          10    100   50567
        Yellow                WRED2          20    100   49965
        Out of Profile
3       Green                WRED1          10    100   50477
        Yellow                WRED2          20    100   49815
        Out of Profile
4       Green                WRED1          10    100   50695
        Yellow                WRED2          20    100   49476
        Out of Profile
5       Green                WRED1          10    100   50245
        Yellow                WRED2          20    100   49535
        Out of Profile
6       Green                WRED1          10    100   50033
        Yellow                WRED2          20    100   49595
        Out of Profile
7       Green                WRED1          10    100   50474
        Yellow                WRED2          20    100   49522
        Out of Profile
FTOS#
```

FTOS Behavior: The C-Series fetches the per-queue packet count via class-maps. The count is the number of packets matching the ACL entries in class-map. Every time the class-map or policy-map is modified, the ACL entries are re-written to the Forwarding Processor, and the queue statistics are cleared. This behavior is different from the E-Series. The E-Series fetches the packet count directly from counters at each queue, which allows queue statistics to persist until explicitly cleared via the CLI.

Figure 38-17. show qos statistics Command Example (S4810 or S4820T)

```
FTOS#show qos statistics wred-profile
Interface Te 0/0
Drop-statistic  WRED-name      Dropped Pkts
-----  -
Green          WRED1          51623
Yellow        WRED2          51300
Out of Profile
FTOS#
```

Pre-calculating Available QoS CAM Space

Pre-calculating Available QoS CAM Space is supported on platforms: C e S

Before version 7.3.1 there was no way to measure the number of CAM entries a policy-map would consume (the number of CAM entries that a rule uses is not predictable; 1 to 16 entries might be used per rule depending upon its complexity). Therefore, it was possible to apply to an interface a policy-map that requires more entries than are available. In this case, the system writes as many entries as possible, and then generates an CAM-full error message ([Message 1](#)). The partial policy-map configuration might cause unintentional system behavior.

Message 1 QoS CAM Region Exceeded

```
%EX2YD:12 %DIFFSERV-2-DSA_QOS_CAM_INSTALL_FAILED: Not enough space in L3
Cam(PolicyQos) for class 2 (Gi 12/20) entries on portpipe 1 for linecard 12
%EX2YD:12 %DIFFSERV-2-
DSA_QOS_CAM_INSTALL_FAILED: Not enough space in L3 Cam(PolicyQos) for class 5 (Gi 12/
22) entries on portpipe 1 for linecard 12
```

The command `test cam-usage` enables you to verify that there are enough available CAM entries *before* applying a policy-map to an interface so that you avoid exceeding the QoS CAM space and partial configurations. This command measures the size of the specified policy-map and compares it to the available CAM space in a partition for a specified port-pipe.

Test the policy-map size against the CAM space for a specific port-pipe or all port-pipes using these commands:

- `test cam-usage service-policy input policy-map {linecard | stack-unit } number port-set number`
- `test cam-usage service-policy input policy-map {linecard | stack-unit } all`

The output of this command, shown in [Figure 38-18](#), displays:

- the estimated number of CAM entries the policy-map will consume
- whether or not the policy-map can be applied
- the number of interfaces in a port-pipe to which the policy-map can be applied

Specifically:

- **Available CAM** is the available number of CAM entries in the specified CAM partition for the specified line card or stack-unit port-pipe.
- **Estimated CAM** is the estimated number of CAM entries that the policy will consume when it is applied to an interface.
- **Status** indicates whether or not the specified policy-map can be completely applied to an interface in the port-pipe.
 - **Allowed** indicates that the policy-map can be applied because the estimated number of CAM entries is less or equal to the available number of CAM entries. The number of interfaces in the port-pipe to which the policy-map can be applied is given in parenthesis.

- **Exception** indicates that the number of CAM entries required to write the policy-map to the CAM is greater than the number of available CAM entries, and therefore the policy-map cannot be applied to an interface in the specified port-pipe.



Note: The command `show cam-usage` provides much of the same information as `test cam-usage`, but whether or not a policy-map can be successfully applied to an interface cannot be determined without first measuring how many CAM entries the policy-map would consume; the command `test cam-usage` is useful because it provides this measurement.

Figure 38-18. test cam-usage Command Example

```
FTOS# test cam-usage service-policy input pmap_l2 linecard 0 port-set 0
```

| Linecard | Port-pipe | CAM Partition | Available CAM | Estimated CAM | Status |
|----------|-----------|---------------|---------------|---------------|------------|
| 0 | 0 | L2ACL | 500 | 200 | Allowed(2) |

Routing Information Protocol (RIP)

Routing Information Protocol (RIP) is supported only on platforms: **E C S** **S4810**

S4820T

RIP is supported on the S-Series following the release of FTOS version 7.8.1.0, and on the C-Series with FTOS versions 7.6.1.0 and after.

Routing Information Protocol (RIP) is based on a distance-vector algorithm, it tracks distances or hop counts to nearby routers when establishing network connections.

- [Protocol Overview on page 783](#)
- [Implementation Information on page 784](#)
- [Configuration Information on page 784](#)
- [RIP Configuration Example on page 792](#)

RIP protocol standards are listed in the [Chapter 56, Standards Compliance](#) chapter.

Protocol Overview

RIP is the oldest interior gateway protocol. There are two versions of RIP: RIP version 1 (RIPv1) and RIP version 2 (RIPv2). These versions are documented in RFCs 1058 and 2453.

RIPv1

RIPv1 learns where nodes in a network are located by automatically constructing a routing data table. The routing table is established after RIP sends out one or more broadcast signals to all adjacent nodes in a network. Hop counts of these signals are tracked and entered into the routing table, which defines where nodes in the network are located.

The information that is used to update the routing table is sent as either a request or response message. In RIPv1, automatic updates to the routing table are performed as either one-time requests or periodic responses (every 30 seconds). RIP transports its responses or requests by means of UDP over port 520.

RIP must receive regular routing updates to maintain a correct routing table. Response messages containing a router's full routing table are transmitted every 30 seconds. If a router does not send an update within a certain amount of time, the hop count to that route is changed to unreachable (a route hop metric of 16 hops). Another timer sets the amount of time before the unreachable routes are removed from the routing table.

This first RIP version does not support VLSM or CIDR and is not widely used.

RIPv2

RIPv2 adds support for subnet fields in the RIP routing updates, thus qualifying it as a classless routing protocol. The RIPv2 message format includes entries for route tags, subnet masks, and next hop addresses. Another enhancement included in RIPv2 is multicasting for route updates on IP multicast address 224.0.0.9.

Implementation Information

FTOS supports both versions of RIP and allows you to configure one version globally and the other version or both versions on the interfaces. The C-Series and E-Series both support 1,000 RIP routes.

Table 39-1 displays the defaults for RIP in FTOS.

Table 39-1. RIP Defaults in FTOS

| Feature | Default |
|------------------------|---|
| Interfaces running RIP | Listen to RIPv1 and RIPv2 Transmit RIPv1 |
| RIP timers | update timer = 30 seconds invalid timer = 180 seconds holddown timer = 180 seconds flush timer = 240 seconds |
| Auto summarization | Enabled |
| ECMP paths supported | 16 |

Configuration Information

By default, RIP is disabled in FTOS. To configure RIP, you must use commands in two modes: ROUTER RIP and INTERFACE. Commands executed in the ROUTER RIP mode configure RIP globally, while commands executed in the INTERFACE mode configure RIP features on that interface only.

RIP is best suited for small, homogeneous networks. All devices within the RIP network must be configured to support RIP if they are to participate in the RIP.

Configuration Task List for RIP

- [Enable RIP globally on page 785](#) (mandatory)
- [Configure RIP on interfaces on page 786](#) (optional)
- [Control RIP routing updates on page 786](#) (optional)

- Set send and receive version on page 788 (optional)
- Generate a default route on page 790 (optional)
- Control route metrics on page 791 (optional)
- Summarize routes on page 790 (optional)
- Control route metrics on page 791
- Debug RIP on page 791

For a complete listing of all commands related to RIP, refer to the *FTOS Command Reference*.

Enable RIP globally

By default, RIP is not enabled in FTOS. To enable RIP, use the following commands in sequence, starting in the CONFIGURATION mode:

| Step | Command Syntax | Command Mode | Purpose |
|------|---------------------------|---------------|---|
| 1 | router rip | CONFIGURATION | Enter ROUTER RIP mode and enable the RIP process on FTOS. |
| 2 | network <i>ip-address</i> | ROUTER RIP | Assign an IP network address as a RIP network to exchange routing information. You can use this command multiple times to exchange RIP information with as many RIP networks as you want. |

After designating networks with which the system is to exchange RIP information, ensure that all devices on that network are configured to exchange RIP information.

The FTOS default is to send RIPv1, and to receive RIPv1 and RIPv2. To change the RIP version globally, use the version command in the ROUTER RIP mode.

When RIP is enabled, you can view the global RIP configuration by using the show running-config command in the EXEC mode or the show config command shown in the following example in the ROUTER RIP mode.

Figure 39-1. show config Command Example in ROUTER RIP mode

```
FTOS(conf-router_rip)#show config
!
router rip
 network 10.0.0.0
FTOS(conf-router_rip)#
```

When the RIP process has learned the RIP routes, use the show ip rip database command in the EXEC mode to view those routes as shown in the following example.

Figure 39-2. show ip rip database Command Example (Partial)

```

FTOS#show ip rip database
Total number of routes in RIP database: 978
160.160.0.0/16
    [120/1] via 29.10.10.12, 00:00:26, Fa 0/0
160.160.0.0/16
    auto-summary
2.0.0.0/8
    [120/1] via 29.10.10.12, 00:01:22, Fa 0/0
2.0.0.0/8
    auto-summary
4.0.0.0/8
    [120/1] via 29.10.10.12, 00:01:22, Fa 0/0
4.0.0.0/8
    auto-summary
8.0.0.0/8
    [120/1] via 29.10.10.12, 00:00:26, Fa 0/0
8.0.0.0/8
    auto-summary
12.0.0.0/8
    [120/1] via 29.10.10.12, 00:00:26, Fa 0/0
12.0.0.0/8
    auto-summary
20.0.0.0/8
    [120/1] via 29.10.10.12, 00:00:26, Fa 0/0
20.0.0.0/8
    auto-summary
29.10.10.0/24
    directly connected, Fa 0/0
29.0.0.0/8
    auto-summary
31.0.0.0/8
    [120/1] via 29.10.10.12, 00:00:26, Fa 0/0
31.0.0.0/8
    auto-summary
192.162.2.0/24
    [120/1] via 29.10.10.12, 00:01:21, Fa 0/0
192.162.2.0/24
    auto-summary
192.161.1.0/24
    [120/1] via 29.10.10.12, 00:00:27, Fa 0/0
192.161.1.0/24
    auto-summary
192.162.3.0/24
    [120/1] via 29.10.10.12, 00:01:22, Fa 0/0
192.162.3.0/24
    auto-summary

```

To disable RIP globally, use the `no router rip` command in the CONFIGURATION mode.

Configure RIP on interfaces

When you enable RIP globally on the system, interfaces meeting certain conditions start receiving RIP routes. By default, interfaces that are enabled and configured with an IP address in the same subnet as the RIP network address receive RIPv1 and RIPv2 routes and send RIPv1 routes.

Assign IP addresses to interfaces that are part of the same subnet as the RIP network identified in the `network` command syntax.

Control RIP routing updates

By default, RIP broadcasts routing information out all enabled interfaces, but you can configure RIP to send or to block RIP routing information, either from a specific IP address or a specific interface. To control which devices or interfaces receive routing updates, you must configure a direct update to one router and configure interfaces to block RIP updates from other sources.

To control the source of RIP route information, use the following commands, in the ROUTER RIP mode:

| Command Syntax | Command Mode | Purpose |
|--|--------------|---|
| <code>neighbor ip-address</code> | ROUTER RIP | Define a specific router to exchange RIP information between it and the Dell Force10 system. You can use this command multiple times to exchange RIP information with as many RIP networks as you want. |
| <code>passive-interface interface</code> | ROUTER RIP | Disable a specific interface from sending or receiving RIP routing information. |

Another method of controlling RIP (or any routing protocol) routing information is to filter the information through a prefix list. A prefix list is applied to incoming or outgoing routes. Those routes must meet the conditions of the prefix list; if not, FTOS drops the route. Prefix lists are globally applied on all interfaces running RIP. Configure the prefix list in the PREFIX LIST mode prior to assigning it to the RIP process.

For configuration information on prefix lists, see [Chapter 17, IP Access Control Lists, Prefix Lists, and Route-maps](#).

To apply prefix lists to incoming or outgoing RIP routes, use the following commands in the ROUTER RIP mode:

| Command Syntax | Command Mode | Purpose |
|---|--------------|---|
| <code>distribute-list prefix-list-name in</code> | ROUTER RIP | Assign a configured prefix list to all incoming RIP routes. |
| <code>distribute-list prefix-list-name out</code> | ROUTER RIP | Assign a configured prefix list to all outgoing RIP routes. |

In addition to filtering routes, you can add routes from other routing instances or protocols to the RIP process. With the redistribute command syntax, you can include OSPF, static, or directly connected routes in the RIP process.

To add routes from other routing instances or protocols, use any of the following commands in the ROUTER RIP mode:

| Command Syntax | Command Mode | Purpose |
|---|--------------|---|
| <code>redistribute {connected static} [metric metric-value] [route-map map-name]</code> | ROUTER RIP | Include directly connected or user-configured (static) routes in RIP. <ul style="list-style-type: none">• <i>metric</i> range: 0 to 16• <i>map-name</i>: name of a configured route map. |

| Command Syntax | Command Mode | Purpose |
|---|--------------|--|
| redistribute isis [level-1 level-1-2 level-2] [metric <i>metric-value</i>] [route-map <i>map-name</i>] | ROUTER RIP | Include IS-IS routes in RIP. <ul style="list-style-type: none"> <i>metric</i> range: 0 to 16 <i>map-name</i>: name of a configured route map. Note: IS-IS is not supported on the S-Series platform. |
| redistribute ospf <i>process-id</i> [match external {1 2} match internal] [metric <i>value</i>] [route-map <i>map-name</i>] | ROUTER RIP | Include specific OSPF routes in RIP. Configure the following parameters: <ul style="list-style-type: none"> <i>process-id</i> range: 1 to 65535 <i>metric</i> range: 0 to 16 <i>map-name</i>: name of a configured route map. |

To view the current RIP configuration, use the show running-config command in the EXEC mode or the show config command in the ROUTER RIP mode.

Set send and receive version

To specify the RIP version, use the version command in the ROUTER RIP mode. To set an interface to receive only one or the other version, use the ip rip send version or the ip rip receive version commands in the INTERFACE mode.

To change the RIP version globally in FTOS, use the following command in the ROUTER RIP mode:

| Command Syntax | Command Mode | Purpose |
|-----------------|--------------|--|
| version {1 2} | ROUTER RIP | Set the RIP version sent and received on the system. |

You can set one RIP version globally on the system. This command sets the RIP version for RIP traffic on the interfaces participating in RIP unless the interface was specifically configured for a specific RIP version.

Use the show config command in the ROUTER RIP mode to see whether the version command is configured. You can also use the show ip protocols command in the EXEC mode to view the routing protocols configuration.

Figure 39-3 shows an example of the RIP configuration after the ROUTER RIP mode version command is set to RIPv2. When the ROUTER RIP mode version command is set, the interface (GigabitEthernet 0/0) participating in the RIP process is also set to send and receive RIPv2.

Figure 39-3. show ip protocols Command Example

```
FTOS#show ip protocols

Routing Protocols is RIP
Sending updates every 30 seconds, next due in 23
Invalid after 180 seconds, hold down 180, flushed after 240
Output delay 8 milliseconds between packets
Automatic network summarization is in effect
Outgoing filter for all interfaces is
Incoming filter for all interfaces is
Default redistribution metric is 1
Default version control: receive version 2, send version 2
  Interface      Recv  Send
  GigabitEthernet 0/0    2
Routing for Networks:
  10.0.0.0

Routing Information Sources:
Gateway          Distance      Last Update

Distance: (default is 120)

FTOS#
```

RIPv2 configured globally and on the interface.

To configure the interfaces to send or receive different RIP versions from the RIP version configured globally, use either of the following commands in the INTERFACE mode:

| Command Syntax | Command Mode | Purpose |
|--------------------------------|--------------|--|
| ip rip receive version [1] [2] | INTERFACE | Set the RIP version(s) received on that interface. |
| ip rip send version [1] [2] | INTERFACE | Set the RIP version(s) sent out on that interface. |

To configure an interface to receive or send both versions of RIP, include 1 and 2 in the command syntax. [Figure 39-4](#) displays the command syntax for sending both RIPv1 and RIPv2 and receiving only RIPv2.

Figure 39-4. Configuring an interface to send both versions of RIP

```
FTOS(conf-if)#ip rip send version 1 2
FTOS(conf-if)#ip rip receive version 2
```

The show ip protocols command example [Figure 39-5](#) confirms that both versions are sent out that interface. This interface no longer sends and receives the same RIP versions as FTOS does globally.

Figure 39-5. show ip protocols Command Example

```

FTOS#show ip protocols

Routing Protocols is RIP
Sending updates every 30 seconds, next due in 11
Invalid after 180 seconds, hold down 180, flushed after 240
Output delay 8 milliseconds between packets
Automatic network summarization is in effect
Outgoing filter for all interfaces is
Incoming filter for all interfaces is
Default redistribution metric is 1
Default version control: receive version 2, send version 2
  Interface      Recv  Send
  FastEthernet 0/0  2     1 2
Routing for Networks:
  10.0.0.0

Routing Information Sources:
Gateway      Distance    Last Update

Distance: (default is 120)

FTOS#

```

Generate a default route

Traffic is forwarded to the default route when the traffic's network is not explicitly listed in the routing table. Default routes are not enabled in RIP unless specified. Use the `default-information originate` command in the ROUTER RIP mode to generate a default route into RIP. In FTOS, default routes received in RIP updates from other routes are advertised if the `default-information originate` command is configured.

To configure FTOS to generate a default route, use the following command in the ROUTER RIP mode:

| Command Syntax | Command Mode | Purpose |
|---|--------------|---|
| <code>default-information originate [always] [metric value] [route-map route-map-name]</code> | ROUTER RIP | Specify the generation of a default route in RIP. Configure the following parameters: <ul style="list-style-type: none"> <code>always</code>: enter this keyword to always generate a default route. <code>value</code> range: 1 to 16. <code>route-map-name</code>: name of a configured route map. |

Use the `show config` command in the ROUTER RIP mode to confirm that the default route configuration is completed.

Summarize routes

Routes in the RIPv2 routing table are summarized by default, thus reducing the size of the routing table and improving routing efficiency in large networks. By default, the `autosummary` command in the ROUTER RIP mode is enabled and summarizes RIP routes up to the classful network boundary.

If you must perform routing between discontinuous subnets, disable automatic summarization. With automatic route summarization disabled, subnets are advertised.

The command `autosummary` requires no other configuration commands. To disable automatic route summarization, in the ROUTER RIP mode, enter `no autosummary`.



Note: If the `ip split-horizon` command is enabled on an interface, then the system does not advertise the summarized address.

Control route metrics

As a distance-vector protocol, RIP uses hop counts to determine the best route, but sometimes the shortest hop count is a route over the lowest-speed link. To manipulate RIP routes so that the routing protocol prefers a different route, you must manipulate the route by using the `offset` command.

Exercise caution when applying an `offset` command to routers on a broadcast network, as the router using the `offset` command is modifying RIP advertisements before sending out those advertisements.

The `distance` command also allows you to manipulate route metrics. Use the command to assign different weights to routes so that the ones with the lower weight or administrative distance assigned are preferred.

To set route metrics, use either of the following commands in the ROUTER RIP mode:

| Command Syntax | Command Mode | Purpose |
|---|--------------|---|
| <code>distance weight [ip-address mask [access-list-name]]</code> | ROUTER RIP | Apply a weight to all routes or a specific route and ACL. Configure the following parameters: <ul style="list-style-type: none"><code>weight</code> range: 1 to 255 (default is 120)<code>ip-address mask</code>: the IP address in dotted decimal format (A.B.C.D), and the mask in slash format (/x).<code>access-list-name</code>: name of a configured IP ACL. |
| <code>offset-list access-list-name {in out} offset [interface]</code> | ROUTER RIP | Apply an additional number to the incoming or outgoing route metrics. Configure the following parameters: <ul style="list-style-type: none"><code>prefix-list-name</code>: the name of an established Prefix list to determine which incoming routes will be modified<code>offset</code> range: 0 to 16.<code>interface</code>: the type, slot, and number of an interface. |

Use the `show config` command in the ROUTER RIP mode to view configuration changes.

Debug RIP

The `debug ip rip` command enables RIP debugging. When debugging is enabled, you can view information on RIP protocol changes or RIP routes.

To enable RIP debugging, use the following command in the EXEC privilege mode:

| Command Syntax | Command Mode | Purpose |
|--|----------------|--------------------------|
| debug ip rip [<i>interface</i> database events trigger] | EXEC privilege | Enable debugging of RIP. |

Figure 39-6 shows the confirmation when the debug function is enabled.

Figure 39-6. debug ip rip Command Example

```
FTOS#debug ip rip
RIP protocol debug is ON
FTOS#
```

To disable RIP, use the no debug ip rip command.

RIP Configuration Example

The example in this section shows the command sequence to configure RIPv2 on the two routers shown in Figure 39-7 — “Core 2” and “Core 3”. The host prompts used in the example screenshots reflect those names. The screenshots are divided into the following groups of command sequences:

- [Configuring RIPv2 on Core 2 on page 793](#)
- [Core 2 Output on page 793](#)
- [RIP Configuration on Core 3 on page 795](#)
- [Core 3 RIP Output on page 795](#)
- [RIP Configuration Summary on page 797](#)

Figure 39-7. RIP Topology Example

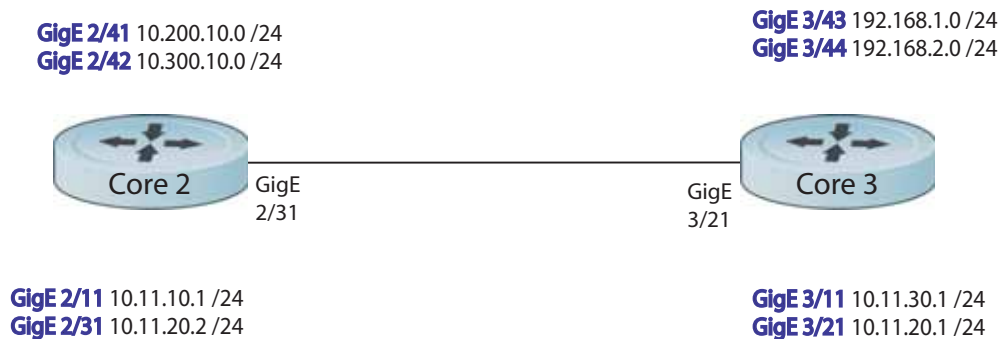

Configuring RIPv2 on Core 2

Figure 39-8. Configuring RIPv2 on Core 2

```
Core2(conf-if-gi-2/31)#
Core2(conf-if-gi-2/31)#router rip
Core2(conf-router_rip)#ver 2
Core2(conf-router_rip)#network 10.200.10.0
Core2(conf-router_rip)#network 10.300.10.0
Core2(conf-router_rip)#network 10.11.10.0
Core2(conf-router_rip)#network 10.11.20.0
Core2(conf-router_rip)#show config
!
router rip
 network 10.0.0.0
 version 2
Core2(conf-router_rip)#
```

Core 2 Output

The screenshots in this section are:

- [Figure 39-9](#): Using show ip rip database command to display Core 2 RIP database
- [Figure 39-10](#): Using show ip route command to display Core 2 RIP setup
- [Figure 39-11](#): Using show ip protocols command to display Core 2 RIP activity

Figure 39-9. Example of RIP Configuration Response from Core 2

```
Core2(conf-router_rip)#end
00:12:24: %RPM0-P:CP %SYS-5-CONFIG_I: Configured from console by console
Core2#show ip rip database
Total number of routes in RIP database: 7
10.11.30.0/24
    [120/1] via 10.11.20.1, 00:00:03, GigabitEthernet 2/31
10.300.10.0/24    directly connected,GigabitEthernet 2/42
10.200.10.0/24    directly connected,GigabitEthernet 2/41
10.11.20.0/24    directly connected,GigabitEthernet 2/31
10.11.10.0/24    directly connected,GigabitEthernet 2/11
10.0.0.0/8        auto-summary
192.168.1.0/24
    [120/1] via 10.11.20.1, 00:00:03, GigabitEthernet 2/31
192.168.1.0/24    auto-summary
192.168.2.0/24
    [120/1] via 10.11.20.1, 00:00:03, GigabitEthernet 2/31
192.168.2.0/24    auto-summary

Core2#
```

Figure 39-10. Using show ip route Command to Show RIP Configuration on Core 2

```
Core2#show ip route

Codes: C - connected, S - static, R - RIP,
       B - BGP, IN - internal BGP, EX - external BGP, LO - Locally Originated,
       O - OSPF, IA - OSPF inter area, N1 - OSPF NSSA external type 1,
       N2 - OSPF NSSA external type 2, E1 - OSPF external type 1,
       E2 - OSPF external type 2, i - IS-IS, L1 - IS-IS level-1,
       L2 - IS-IS level-2, IA - IS-IS inter area, * - candidate default,
       > - non-active route, + - summary route

Gateway of last resort is not set

Destination          Gateway              Dist/Metric Last Change
-----
C    10.11.10.0/24     Direct, Gi 2/11          0/0    00:02:26
C    10.11.20.0/24     Direct, Gi 2/31          0/0    00:02:02
R    10.11.30.0/24     via 10.11.20.1, Gi 2/31 120/1   00:01:20
C    10.200.10.0/24    Direct, Gi 2/41          0/0    00:03:03
C    10.300.10.0/24    Direct, Gi 2/42          0/0    00:02:42
R    192.168.1.0/24    via 10.11.20.1, Gi 2/31 120/1   00:01:20
R    192.168.2.0/24    via 10.11.20.1, Gi 2/31 120/1   00:01:20
Core2#
R    192.168.1.0/24    via 10.11.20.1, Gi 2/31 120/1   00:05:22
R    192.168.2.0/24    via 10.11.20.1, Gi 2/31 120/1   00:05:22

Core2#
```

Figure 39-11. Using show ip protocols Command to Show RIP Configuration Activity on Core 2

```
Core2#show ip protocols
Routing Protocol is "RIP"
  Sending updates every 30 seconds, next due in 17
  Invalid after 180 seconds, hold down 180, flushed after 240
  Output delay 8 milliseconds between packets
  Automatic network summarization is in effect
  Outgoing filter for all interfaces is
  Incoming filter for all interfaces is
  Default redistribution metric is 1
  Default version control: receive version 2, send version 2
    Interface      Recv  Send
    GigabitEthernet 2/42    2     2
    GigabitEthernet 2/41    2     2
    GigabitEthernet 2/31    2     2
    GigabitEthernet 2/11    2     2
  Routing for Networks:
    10.300.10.0
    10.200.10.0
    10.11.20.0
    10.11.10.0

  Routing Information Sources:
  Gateway          Distance      Last Update
  10.11.20.1        120           00:00:12

  Distance: (default is 120)

Core2#
```

RIP Configuration on Core 3

Figure 39-12. RIP Configuration on Core 3

```
Core3(conf-if-gi-3/21)#router rip
Core3(conf-router_rip)#version 2
Core3(conf-router_rip)#network 192.168.1.0
Core3(conf-router_rip)#network 192.168.2.0
Core3(conf-router_rip)#network 10.11.30.0
Core3(conf-router_rip)#network 10.11.20.0
Core3(conf-router_rip)#show config
!
router rip
 network 10.0.0.0
 network 192.168.1.0
 network 192.168.2.0
 version 2
Core3(conf-router_rip)#
```

Core 3 RIP Output

The screenshots in this section are:

- [Figure 39-13](#): Using show ip rip database command to display Core 3 RIP database
- [Figure 39-14](#): Using show ip route command to display Core 3 RIP setup
- [Figure 39-15](#): Using show ip protocols command to display Core 3 RIP activity

Figure 39-13. Using show ip rip database Command for Core 3 RIP Setup

```
Core3#show ip rip database
Total number of routes in RIP database: 7
10.11.10.0/24
    [120/1] via 10.11.20.2, 00:00:13, GigabitEthernet 3/21
10.200.10.0/24
    [120/1] via 10.11.20.2, 00:00:13, GigabitEthernet 3/21
10.300.10.0/24
    [120/1] via 10.11.20.2, 00:00:13, GigabitEthernet 3/21
10.11.20.0/24        directly connected,GigabitEthernet 3/21
10.11.30.0/24       directly connected,GigabitEthernet 3/11
10.0.0.0/8          auto-summary
192.168.1.0/24      directly connected,GigabitEthernet 3/43
192.168.1.0/24      auto-summary
192.168.2.0/24      directly connected,GigabitEthernet 3/44
192.168.2.0/24      auto-summary
Core3#
```

Figure 39-14. Using show ip routes for Core 3 RIP Setup

```

Core3#show ip routes

Codes: C - connected, S - static, R - RIP,
       B - BGP, IN - internal BGP, EX - external BGP, LO - Locally Originated,
       O - OSPF, IA - OSPF inter area, N1 - OSPF NSSA external type 1,
       N2 - OSPF NSSA external type 2, E1 - OSPF external type 1,
       E2 - OSPF external type 2, i - IS-IS, L1 - IS-IS level-1,
       L2 - IS-IS level-2, IA - IS-IS inter area, * - candidate default,
       > - non-active route, + - summary route

Gateway of last resort is not set

      Destination            Gateway                     Dist/Metric  Last Change
      -----            -
R    10.11.10.0/24          via 10.11.20.2, Gi 3/21    120/1       00:01:14
C    10.11.20.0/24          Direct, Gi 3/21           0/0         00:01:53
C    10.11.30.0/24          Direct, Gi 3/11           0/0         00:06:00
R    10.200.10.0/24         via 10.11.20.2, Gi 3/21    120/1       00:01:14
R    10.300.10.0/24         via 10.11.20.2, Gi 3/21    120/1       00:01:14
C    192.168.1.0/24         Direct, Gi 3/43           0/0         00:06:53
C    192.168.2.0/24         Direct, Gi 3/44           0/0         00:06:26
Core3#

```

Figure 39-15. Using show ip protocols Command to Show RIP Configuration Activity on Core 3

```

Core3#show ip protocols

Routing Protocol is "RIP"
  Sending updates every 30 seconds, next due in 6
  Invalid after 180 seconds, hold down 180, flushed after 240
  Output delay 8 milliseconds between packets
  Automatic network summarization is in effect
  Outgoing filter for all interfaces is
  Incoming filter for all interfaces is
  Default redistribution metric is 1
  Default version control: receive version 2, send version 2
    Interface      Recv  Send
    GigabitEthernet 3/21    2    2
    GigabitEthernet 3/11    2    2
    GigabitEthernet 3/44    2    2
    GigabitEthernet 3/43    2    2
  Routing for Networks:
    10.11.20.0
    10.11.30.0
    192.168.2.0
    192.168.1.0

  Routing Information Sources:
  Gateway          Distance      Last Update
  10.11.20.2        120          00:00:22

  Distance: (default is 120)
Core3#

```

RIP Configuration Summary

Figure 39-16. Summary of Core 2 RIP Configuration Using Output of show run Command

```
!  
interface GigabitEthernet 2/11  
 ip address 10.11.10.1/24  
 no shutdown  
!  
interface GigabitEthernet 2/31  
 ip address 10.11.20.2/24  
 no shutdown  
!  
interface GigabitEthernet 2/41  
 ip address 10.200.10.1/24  
 no shutdown  
!  
interface GigabitEthernet 2/42  
 ip address 10.250.10.1/24  
 no shutdown  
  
router rip  
version 2  
10.200.10.0  
10.300.10.0  
10.11.10.0  
10.11.20.0
```

Figure 39-17. Summary of Core 3 RIP Configuration Using Output of show run Command

```
!  
interface GigabitEthernet 3/11  
 ip address 10.11.30.1/24  
 no shutdown  
!  
interface GigabitEthernet 3/21  
 ip address 10.11.20.1/24  
 no shutdown  
!  
interface GigabitEthernet 3/43  
 ip address 192.168.1.1/24  
 no shutdown  
!  
interface GigabitEthernet 3/44  
 ip address 192.168.2.1/24  
 no shutdown  
!  
router rip  
version 2  
network 10.11.20.0  
network 10.11.30.0  
network 192.168.1.0  
network 192.168.2.0
```

Remote Monitoring (RMON)

Remote Monitoring (RMON) is supported on platform: e c s **S4810** **S4820T**

This chapter describes the Remote Monitoring (RMON):

- [Implementation on page 799](#)
- [Fault Recovery on page 800](#)

Remote Monitoring (RMON) is an industry-standard implementation that monitors network traffic by sharing network monitoring information. RMON provides both 32-bit and 64-bit monitoring facility and long-term statistics collection on Dell Force10 Ethernet Interfaces.

RMON operates with SNMP and monitors all nodes on a LAN segment. RMON monitors traffic passing through the router and segment traffic not destined for the router. The monitored interfaces may be chosen by using alarms and events with standard MIBs.

Implementation

You must configure SNMP prior to setting up RMON. For a complete SNMP implementation discussion, refer to [Chapter 6, Simple Network Management Protocol \(SNMP\)](#).

Configuring RMON requires using the RMON CLI and includes the following tasks:

- [Set rmon alarm](#)
- [Configure an RMON event](#)
- [Configure RMON collection statistics](#)
- [Configure RMON collection history](#)
- [Enable an RMON MIB collection history group](#)

RMON implements the following standard RFCs (for details see [Chapter 56, Standards Compliance](#)):

- RFC-2819
- RFC-3273
- RFC-3434

Fault Recovery

RMON provides the following fault recovery functions:

Interface Down—When an RMON-enabled interface goes down, monitoring continues. However, all data values are registered as 0xFFFFFFFF (32 bits) or ixFFFFFFFFFFFFFFFF (64 bits). When the interface comes back up, RMON monitoring processes resumes.



Note: A Network Management System (NMS) should be ready to interpret a down interface and plot the interface performance graph accordingly.

Line Card Down—The same as Interface Down (see above).

RPM Down, RPM Failover—Master and standby RPMs run the RMON sampling process in the background. Therefore, when an RPM goes down, the other RPM maintains the sampled data—the new master RPM provides the same sampled data as did the old master—as long as the master RPM had been running long enough to sample all the data.

NMS backs up all the long-term data collection, and displays the failover downtime from the performance graph.

Chassis Down—When a chassis goes down, all sampled data is lost. But the RMON configurations are saved in the configuration file, and the sampling process continues after the chassis returns to operation.

Platform Adaptation—RMON supports all Dell Force10 chassis and all Dell Force10 Ethernet Interfaces.

Set rmon alarm

To set an alarm on any MIB object, use the `rmon alarm` or `rmon hc-alarm` command in GLOBAL CONFIGURATION mode. To disable the alarm, use the `no` form of this command:

| Command Syntax | Command Mode | Purpose |
|--|---------------|---|
| <pre>[no] rmon alarm number variable interval {delta absolute} rising-threshold [value event-number] falling-threshold value event-number [owner string] or [no] rmon hc-alarm number variable interval {delta absolute} rising-threshold value event-number falling-threshold value event-number [owner string]</pre> | CONFIGURATION | <p>Set an alarm on any MIB object. Use the no form of this command to disable the alarm.</p> <p>Configure the alarm using the following optional parameters:</p> <ul style="list-style-type: none">• number: Alarm number, should be an integer from 1 to 65,535, the value must be unique in the RMON Alarm Table• variable: The MIB object to monitor—the variable must be in the SNMP OID format. For example, 1.3.6.1.2.1.1.3. The object type must be a 32-bit integer for the rmon alarm command and 64 bits for the rmon hc-alarm command.• interval: Time in seconds the alarm monitors the MIB variable, the value must be between 1 to 3,600.• delta: Tests the change between MIB variables, this is the <i>alarmSampleType</i> in the RMON Alarm table.• absolute: Tests each MIB variable directly, this is the <i>alarmSampleType</i> in the RMON Alarm table.• rising-threshold value: Value at which the rising-threshold alarm is triggered or reset. For the rmon alarm command this is a 32-bits value, for rmon hc-alarm command this is a 64-bits value.• event-number: Event number to trigger when the rising threshold exceeds its limit. This value is identical to the <i>alarmRisingEventIndex</i> in the alarmTable of the RMON MIB. If there is no corresponding rising-threshold event, the value should be zero.• falling-threshold value: Value at which the falling-threshold alarm is triggered or reset. For the rmon alarm command, this is a 32-bits value, for rmon hc-alarm command this is a 64bits value.• event-number: Event number to trigger when the falling threshold exceeds its limit. This value is identical to the <i>alarmFallingEventIndex</i> in the alarmTable of the RMON MIB. If there is no corresponding falling-threshold event, the value should be zero.• owner string: (Optional) Specifies an owner for the alarm, this is the alarmOwner object in the alarmTable of the RMON MIB. Default is a null-terminated string. |

The following example configures an RMON alarm using the `rmon alarm` command.

Figure 40-1. rmon alarm Command Example

```

FTOS(conf)#rmon alarm 10 1.3.6.1.2.1.2.2.1.20.1 20 delta rising-threshold 15 1 falling-threshold 0
owner nms1

```

Alarm Number MIB Variable Monitor Interval Counter Value Limit Triggered Event

The above example configures RMON alarm number 10. The alarm monitors the MIB variable 1.3.6.1.2.1.2.2.1.20.1 (ifEntry.ifOutErrors) once every 20 seconds until the alarm is disabled, and checks the rise or fall of the variable. The alarm is triggered when the 1.3.6.1.2.1.2.2.1.20.1 value shows a MIB counter increase of 15 or more (such as from 100000 to 100015). The alarm then triggers event number 1, which is configured with the RMON event command. Possible events include a log entry or a SNMP trap. If the 1.3.6.1.2.1.2.2.1.20.1 value changes to 0 (falling-threshold 0), the alarm is reset and can be triggered again.

Configure an RMON event

To add an event in the RMON event table, use the `rmon event` command in GLOBAL CONFIGURATION mode. To disable RMON on the interface, use the `no` form of this command:

| Command Syntax | Command Mode | Purpose |
|--|---------------|---|
| <code>[no] rmon event number [log] [trap community] [description string] [owner string]</code> | CONFIGURATION | <p><i>number</i>: Assigned event number, which is identical to the eventIndex in the eventTable in the RMON MIB. The value must be an integer from 1 to 65,535, the value must be unique in the RMON Event Table.</p> <p><i>log</i>: (Optional) Generates an RMON log entry when the event is triggered and sets the eventType in the RMON MIB to log or log-and-trap. Default is no log.</p> <p>trap community: (Optional) SNMP community string used for this trap. Configures the setting of the eventType in the RMON MIB for this row as either snmp-trap or log-and-trap. This value is identical to the eventCommunityValue in the eventTable in the RMON MIB. Default is "public".</p> <p>description string: (Optional) Specifies a description of the event, which is identical to the event description in the eventTable of the RMON MIB. Default is a null-terminated string.</p> <p>owner string: (Optional) Owner of this event, which is identical to the eventOwner in the eventTable of the RMON MIB. Default is a null-terminated string.</p> |

The following example shows the `rmon event` command.

Figure 40-2. rmon event Command Example

```
FTOS(conf)#rmon event 1 log trap eventtrap description "High ifOutErrors" owner nms1
```

The above configuration example creates RMON event number 1, with the description “High ifOutErrors”, and generates a log entry when the event is triggered by an alarm. The user *nms1* owns the row that is created in the event table by this command. This configuration also generates an SNMP trap when the event is triggered using the SNMP community string “eventtrap”.

Configure RMON collection statistics

To enable RMON MIB statistics collection on an interface, use the RMON collection statistics command in interface configuration mode. To remove a specified RMON statistics collection, use the *no* form of this command.

| Command Syntax | Command Mode | Purpose |
|---|---|---|
| [no] rmon collection statistics { controlEntry <i>integer</i> } [owner <i>ownername</i>] | CONFIGURATION INTERFACE (config-if) | controlEntry: Specifies the RMON group of statistics using a value. <i>integer:</i> A value from 1 to 65,535 that identifies the RMON Statistics Table. The value must be unique in the RMON Statistic Table. owner: (Optional) Specifies the name of the owner of the RMON group of statistics. <i>ownername:</i> (Optional) Records the name of the owner of the RMON group of statistics. Default is a null-terminated string |

The following command enables the RMON statistics collection on the interface, with an ID value of 20 and an owner of “john.”

Figure 40-3. rmon collection statistics Command Example

```
FTOS(config-if-mgmt)#rmon collection statistics controlEntry 20 owner john
```

Configure RMON collection history

To enable the RMON MIB history group of statistics collection on an interface, use the `rmon collection history` command in interface configuration mode. To remove a specified RMON history group of statistics collection, use the `no` form of this command.

| Command Syntax | Command Mode | Purpose |
|--|---|---|
| [no] <code>rmon collection history</code> {controlEntry integer} [owner ownername] [buckets bucket-number] [interval seconds] | CONFIGURATION INTERFACE (config-if) | <p>controlEntry: Specifies the RMON group of statistics using a value.</p> <p><i>integer:</i> A value from 1 to 65,535 that identifies the RMON group of statistics. The value must be a unique index in the RMON History Table.</p> <p>owner: (Optional) Specifies the name of the owner of the RMON group of statistics. Default is a null-terminated string.</p> <p><i>ownername:</i> (Optional) Records the name of the owner of the RMON group of statistics.</p> <p>buckets: (Optional) Specifies the maximum number of buckets desired for the RMON collection history group of statistics.</p> <p><i>bucket-number:</i> (Optional) A value associated with the number of buckets specified for the RMON collection history group of statistics. The value is limited to from 1 to 1000. Default is 50 (as defined in RFC-2819).</p> <p>interval: (Optional) Specifies the number of seconds in each polling cycle.</p> <p><i>seconds:</i> (Optional) The number of seconds in each polling cycle. The value is ranged from 5 to 3,600 (Seconds). Default is 1,800 as defined in RFC-2819.</p> |

Enable an RMON MIB collection history group

The following command enables an RMON MIB collection history group of statistics with an ID number of 20 and an owner of “john”, both the sampling interval and the number of buckets use their respective defaults.

Figure 40-4. rmon collection history Command Example

```
FTOS(conf-if-mgmt)#rmon collection history controlEntry 20 owner john
```

Rapid Spanning Tree Protocol (RSTP)

Rapid Spanning Tree Protocol (RSTP) is supported on platforms: **e c s** **S4810**
S4820T

Protocol Overview

Rapid Spanning Tree Protocol (RSTP) is a Layer 2 protocol—specified by IEEE 802.1w—that is essentially the same as Spanning-Tree Protocol (STP) but provides faster convergence and interoperability with switches configured with STP and MSTP.

FTOS supports three other variations of Spanning Tree, as shown in [Table 41-1](#).

Table 41-1. FTOS Supported Spanning Tree Protocols

| Dell Force10 Term | IEEE Specification |
|--|--------------------|
| Spanning Tree Protocol (STP) | 802.1d |
| Rapid Spanning Tree Protocol (RSTP) | 802.1w |
| Multiple Spanning Tree Protocol (MSTP) | 802.1s |
| Per-VLAN Spanning Tree Plus (PVST+) | Third Party |

Configuring Rapid Spanning Tree

Configuring Rapid Spanning Tree is a two-step process:

1. Configure interfaces for Layer 2. See [page 48](#).
2. Enable Rapid Spanning Tree Protocol. See [page 49](#).

Related Configuration Tasks

- [Add and Remove Interfaces on page 811](#)
- [Modify Global Parameters on page 811](#)
- [Modify Interface Parameters on page 812](#)

- [Configure an EdgePort on page 813](#)
- [Preventing Network Disruptions with BPDU Guard on page 953](#)
- [Influence RSTP Root Selection on page 814](#)
- [Configuring Spanning Trees as Hitless on page 959](#)
- [SNMP Traps for Root Elections and Topology Changes on page 815](#)
- [Fast Hellos for Link State Detection on page 815](#)
- [Flush MAC Addresses after a Topology Change on page 667](#)

Important Points to Remember

- RSTP is disabled by default.
- FTOS supports only one Rapid Spanning Tree (RST) instance.
- All interfaces in VLANs and all enabled interfaces in Layer 2 mode are automatically added to the RST topology.
- Avoid using the range command to add a large group of ports to a large group of VLANs; adding a group of ports to a range of VLANs sends multiple messages to the RSTP task. When using the range command, Dell Force10 recommends limiting the range to 5 ports and 40 VLANs.

RSTP and VLT

VLT provides loop-free redundant topologies and does not require rapid spanning tree protocol (RSTP). RSTP can cause temporary port state blocking and may cause topology changes after link or node failures. Spanning tree topology changes are distributed to the entire layer 2 network, which can cause a network-wide flush of learned MAC and ARP addresses, requiring these addresses to be re-learned. However, enabling RSTP can detect potential loops caused by non-system issues such as cabling errors or incorrect configurations. RSTP is useful for potential loop detection but should be configured using the specifications below to minimize possible topology changes after link or node failure.

The following recommendations will help you avoid these issues and the associated traffic loss caused by using rapid spanning trees when VLT is enabled on both VLT peers:

- Any ports at the edge of the spanning tree's operating domain should be configured as edge ports, which are directly connected to end stations or server racks. Ports connected directly to layer 3-only routers not running STP should have RSTP disabled or be configured as edge ports.
- Ensure the primary VLT node is the root bridge and the secondary VLT peer node has the second-best bridge ID in the network. If the primary VLT peer node fails, the secondary VLT peer node becomes the root bridge, avoiding problems with spanning tree port state changes that occur when a VLT node fails or recovers.
- Even with this configuration, if the node has non-VLT ports using RSTP that are not configured as edge ports and are connected to other layer 2 switches, spanning tree topology changes can still be detected after VLT node recovery. To avoid this scenario, ensure that any non-VLT ports are configured as edge ports or have RSTP disabled.

Configure Interfaces for Layer 2 Mode

All interfaces on all bridges that will participate in Rapid Spanning Tree must be in Layer 2 and enabled.

Figure 41-1. Configuring Interfaces for Layer 2 Mode

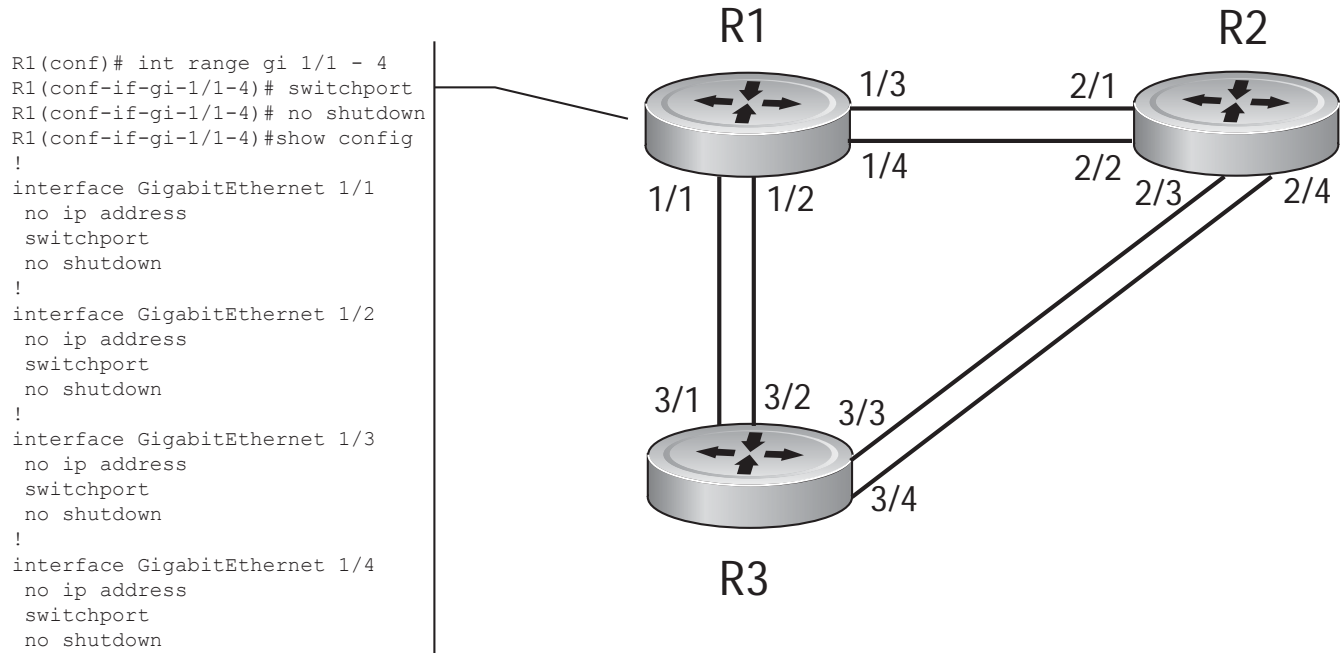

To configure the interfaces for Layer 2 and then enable them:

| Step | Task | Command Syntax | Command Mode |
|------|--|----------------|--------------|
| 1 | If the interface has been assigned an IP address, remove it. | no ip address | INTERFACE |
| 2 | Place the interface in Layer 2 mode. | switchport | INTERFACE |
| 3 | Enable the interface. | no shutdown | INTERFACE |

Verify that an interface is in Layer 2 mode and enabled using the show config command from INTERFACE mode.

Figure 41-2. Verifying Layer 2 Configuration

```

FTOS(conf-if-gi-1/1)#show config
!
interface GigabitEthernet 1/1
no ip address
switchport
no shutdown
FTOS(conf-if-gi-1/1)#

```

← **Indicates that the interface is in Layer 2 mode**

Enable Rapid Spanning Tree Protocol Globally

Rapid Spanning Tree Protocol must be enabled globally on all participating bridges; it is not enabled by default.

To enable Rapid Spanning Tree globally for all Layer 2 interfaces:

| Step | Task | Command Syntax | Command Mode |
|------|---|-----------------------------|-----------------------------|
| 1 | Enter the PROTOCOL SPANNING TREE RSTP mode. | protocol spanning-tree rstp | CONFIGURATION |
| 2 | Enable Rapid Spanning Tree. | no disable | PROTOCOL SPANNING TREE RSTP |



Note: To disable RSTP globally for all Layer 2 interfaces, enter the disable command from PROTOCOL SPANNING TREE RSTP mode.

Verify that Rapid Spanning Tree is enabled using the show config command from PROTOCOL SPANNING TREE RSTP mode.

Figure 41-3. Verifying RSTP is Enabled

```
FTOS(conf-rstp)#show config
!
protocol spanning-tree rstp
no disable
FTOS(conf-rstp)#
```

← Indicates that Rapid Spanning Tree is enabled

When you enable Rapid Spanning Tree, all physical and port-channel interfaces that are enabled and in Layer 2 mode are automatically part of the RST topology.

- Only one path from any bridge to any other bridge is enabled.
- Bridges block a redundant path by disabling one of the link ports.

Figure 41-4. Rapid Spanning Tree Enabled Globally

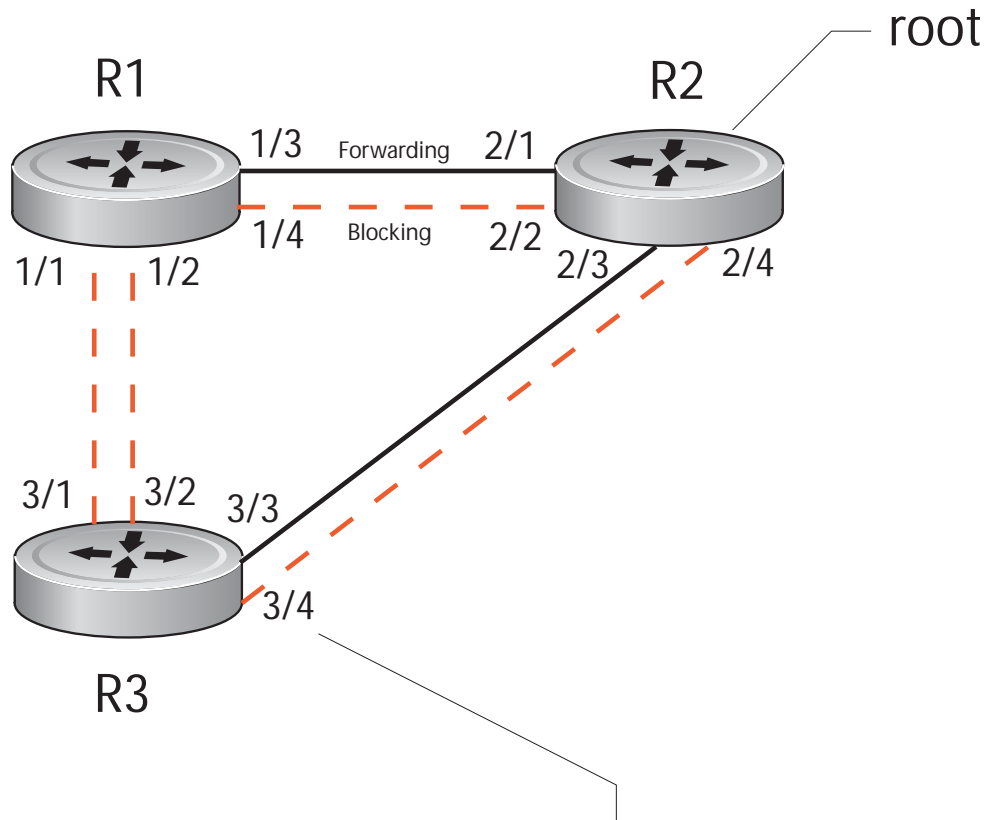

```
Port 684 (GigabitEthernet 4/43) is alternate Discarding
Port path cost 20000, Port priority 128, Port Identifier 128.684
Designated root has priority 32768, address 0001.e801.cbb4
Designated bridge has priority 32768, address 0001.e801.cbb4
Designated port id is 128.684, designated path cost 20000
Number of transitions to forwarding state 0
BPDU : sent 3, received 219
The port is not in the Edge port mode
```

View the interfaces participating in Rapid Spanning Tree using the `show spanning-tree rstp` command from EXEC privilege mode. If a physical interface is part of a port channel, only the port channel is listed in the command output.

Figure 41-5. show spanning-tree rstp Command Example

```
FTOS#show spanning-tree rstp
Root Identifier has priority 32768, Address 0001.e801.cbb4
Root Bridge hello time 2, max age 20, forward delay 15, max hops 0
Bridge Identifier has priority 32768, Address 0001.e801.cbb4
Configured hello time 2, max age 20, forward delay 15, max hops 0
We are the root
Current root has priority 32768, Address 0001.e801.cbb4
Number of topology changes 4, last change occurred 00:02:17 ago on Gi 1/26

Port 377 (GigabitEthernet 2/1) is designated Forwarding
Port path cost 20000, Port priority 128, Port Identifier 128.377
Designated root has priority 32768, address 0001.e801.cbb4
Designated bridge has priority 32768, address 0001.e801.cbb4
Designated port id is 128.377, designated path cost 0
Number of transitions to forwarding state 1
BPDU : sent 121, received 9
The port is not in the Edge port mode

Port 378 (GigabitEthernet 2/2) is designated Forwarding
Port path cost 20000, Port priority 128, Port Identifier 128.378
Designated root has priority 32768, address 0001.e801.cbb4
Designated bridge has priority 32768, address 0001.e801.cbb4
Designated port id is 128.378, designated path cost 0
Number of transitions to forwarding state 1
BPDU : sent 121, received 2
The port is not in the Edge port mode

Port 379 (GigabitEthernet 2/3) is designated Forwarding
Port path cost 20000, Port priority 128, Port Identifier 128.379
Designated root has priority 32768, address 0001.e801.cbb4
Designated bridge has priority 32768, address 0001.e801.cbb4
Designated port id is 128.379, designated path cost 0
Number of transitions to forwarding state 1
BPDU : sent 121, received 5
The port is not in the Edge port mode

Port 380 (GigabitEthernet 2/4) is designated Forwarding
Port path cost 20000, Port priority 128, Port Identifier 128.380
Designated root has priority 32768, address 0001.e801.cbb4
Designated bridge has priority 32768, address 0001.e801.cbb4
Designated port id is 128.380, designated path cost 0

Number of transitions to forwarding state 1
BPDU : sent 147, received 3
The port is not in the Edge port mode
```

Confirm that a port is participating in Rapid Spanning Tree using the show spanning-tree rstp brief command from EXEC privilege mode.

Figure 41-6. show spanning-tree rstp brief Command Example

```
R3#show spanning-tree rstp brief
Executing IEEE compatible Spanning Tree Protocol
Root ID      Priority 32768, Address 0001.e801.cbb4
Root Bridge hello time 2, max age 20, forward delay 15
Bridge ID    Priority 32768, Address 0001.e80f.1dad
Configured hello time 2, max age 20, forward delay 15
Interface
  Name      PortID  Prio Cost   Sts Cost      Designated
  -----  -----  ---  ---   ---  ---      -----  -----
Gi 3/1     128.681 128 20000  BLK 20000  32768 0001.e80b.88bd 128.469
Gi 3/2     128.682 128 20000  BLK 20000  32768 0001.e80b.88bd 128.470
Gi 3/3     128.683 128 20000  FWD 20000  32768 0001.e801.cbb4 128.379
Gi 3/4     128.684 128 20000  BLK 20000  32768 0001.e801.cbb4 128.380
Interface
  Name      Role   PortID  Prio Cost   Sts Cost      Link-type Edge
  -----  -----  -----  ---  ---   ---  ---      -----  -----
Gi 3/1     Altr  128.681 128 20000  BLK 20000  P2P      No
Gi 3/2     Altr  128.682 128 20000  BLK 20000  P2P      No
Gi 3/3     Root  128.683 128 20000  FWD 20000  P2P      No
Gi 3/4     Altr  128.684 128 20000  BLK 20000  P2P      No
R3#
```

Add and Remove Interfaces

- To add an interface to the Rapid Spanning Tree topology, configure it for Layer 2 and it is automatically added. If you previously disabled RSTP on the interface using the command `no spanning-tree 0`, re-enable it using the command `spanning-tree 0`.
- Remove an interface from the Rapid Spanning Tree topology using the command `no spanning-tree 0`. See also [Removing an Interface from the Spanning Tree Group on page 950](#) for BPDU Filtering behavior.

Modify Global Parameters

You can modify Rapid Spanning Tree parameters. The root bridge sets the values for forward-delay, hello-time, and max-age and overwrites the values set on other bridges participating in the Rapid Spanning Tree group.

- **Forward-delay** is the amount of time an interface waits in the Listening State and the Learning State before it transitions to the Forwarding State.
- **Hello-time** is the time interval in which the bridge sends RSTP Bridge Protocol Data Units (BPDUs).
- **Max-age** is the length of time the bridge maintains configuration information before it refreshes that information by recomputing the RST topology.



Note: Dell Force10 recommends that only experienced network administrators change the Rapid Spanning Tree group parameters. Poorly planned modification of the RSTG parameters can negatively impact network performance.

Table 41-2 displays the default values for RSTP.

Table 41-2. RSTP Default Values

| RSTP Parameter | | Default Value |
|----------------|--|---------------|
| Forward Delay | | 15 seconds |
| Hello Time | | 2 seconds |
| Max Age | | 20 seconds |
| Port Cost | 100-Mb/s Ethernet interfaces | 200000 |
| | 1-Gigabit Ethernet interfaces | 20000 |
| | 10-Gigabit Ethernet interfaces | 2000 |
| | Port Channel with 100 Mb/s Ethernet interfaces | 180000 |
| | Port Channel with 1-Gigabit Ethernet interfaces | 18000 |
| | Port Channel with 10-Gigabit Ethernet interfaces | 1800 |
| Port Priority | | 128 |

To change these parameters, use the following commands, on the root bridge:

| Task | Command Syntax | Command Mode |
|---|---|-----------------------------------|
| Change the forward-delay parameter. <ul style="list-style-type: none"> Range: 4 to 30 Default: 15 seconds | <code>forward-delay <i>seconds</i></code> | PROTOCOL SPANNING TREE RSTP |
| Change the hello-time parameter. Note: With large configurations (especially those with more ports) Dell Force10 recommends that you increase the hello-time. Range: 1 to 10 Default: 2 seconds | <code>hello-time <i>seconds</i></code> | PROTOCOL SPANNING TREE RSTP |
| Change the max-age parameter. Range: 6 to 40 Default: 20 seconds | <code>max-age <i>seconds</i></code> | PROTOCOL SPANNING TREE RSTP |

View the current values for global parameters using the `show spanning-tree rstp` command from EXEC privilege mode. See [Figure 41-5](#).

Modify Interface Parameters

On interfaces in Layer 2 mode, you can set the port cost and port priority values.

- **Port cost** is a value that is based on the interface type. The default values are listed in [Table 41-2](#). The greater the port cost, the less likely the port will be selected to be a forwarding port.

- **Port priority** influences the likelihood that a port will be selected to be a forwarding port in case that several ports have the same port cost.

To change the port cost or priority of an interface, use the following commands:

| Task | Command Syntax | Command Mode |
|---|--|--------------|
| Change the port cost of an interface. Range: 0 to 65535 Default: see Table 41-2 . | <code>spanning-tree rstp cost <i>cost</i></code> | INTERFACE |
| Change the port priority of an interface. Range: 0 to 15 Default: 128 | <code>spanning-tree rstp priority <i>priority-value</i></code> | INTERFACE |

View the current values for interface parameters using the `show spanning-tree rstp` command from EXEC privilege mode. See [Figure 41-5](#).

Configure an EdgePort

The EdgePort feature enables interfaces to begin forwarding traffic approximately 30 seconds sooner. In this mode an interface forwards frames by default until it receives a BPDU that indicates that it should behave otherwise; it does not go through the Learning and Listening states. The `bpduguard shutdown-on-violation` option causes the interface hardware to be shutdown when it receives a BPDU. When only `bpduguard` is implemented, although the interface is placed in an Error Disabled state when receiving the BPDU, the physical interface remains up and spanning-tree will drop packets in the hardware after a BPDU violation. BPDUs are dropped in the software after receiving the BPDU violation. This feature is the same as PortFast mode in Spanning Tree.



Caution: Configure EdgePort only on links connecting to an end station. EdgePort can cause loops if it is enabled on an interface connected to a network.

To enable EdgePort on an interface, use the following command:

| Task | Command Syntax | Command Mode |
|----------------------------------|---|--------------|
| Enable EdgePort on an interface. | <code>spanning-tree rstp edge-port [bpduguard shutdown-on-violation]</code> | INTERFACE |

Verify that EdgePort is enabled on a port using the `show spanning-tree rstp` command from the EXEC privilege mode or the `show config` command from INTERFACE mode; Dell Force10 recommends using the `show config` command, as shown in [Figure 41-7](#).

FTOS Behavior: Regarding bpduguard shutdown-on-violation behavior:

- 1 If the interface to be shutdown is a port channel then all the member ports are disabled in the hardware.
- 2 When a physical port is added to a port channel already in error disable state, the new member port will also be disabled in the hardware.
- 3 When a physical port is removed from a port channel in error disable state, the error disabled state is cleared on this physical port (the physical port will be enabled in the hardware).
- 4 The reset linecard command does not clear the error disabled state of the port or the hardware disabled state. The interface continues to be disabled in the hardware.

The error disabled state can be cleared with any of the following methods:

- Perform an shutdown command on the interface.
- Disable the shutdown-on-violation command on the interface (no spanning-tree stp-id portfast [bpduguard | [shutdown-on-violation]]).
- Disable spanning tree on the interface (no spanning-tree in INTERFACE mode).
- Disabling global spanning tree (no spanning-tree in CONFIGURATION mode).

Figure 41-7. EdgePort Enabled on Interface

```
FTOS(conf-if-gi-2/0)#show config
!
interface GigabitEthernet 2/0
no ip address
switchport
spanning-tree rstp edge-port ← Indicates the interface is in EdgePort mode
shutdown
FTOS(conf-if-gi-2/0)#
```

Influence RSTP Root Selection

The Rapid Spanning Tree Protocol determines the root bridge, but you can assign one bridge a lower priority to increase the likelihood that it will be selected as the root bridge.

To change the bridge priority, use the following command:

| Task | Command Syntax | Command Mode |
|---|---------------------------------------|-----------------------------------|
| Assign a number as the bridge priority or designate it as the primary or secondary root. <i>priority-value</i> range: 0 to 65535. The lower the number assigned, the more likely this bridge will become the root bridge. The default is 32768. Entries must be multiples of 4096. | bridge-priority <i>priority-value</i> | PROTOCOL SPANNING TREE RSTP |

A console message appears when a new root bridge has been assigned. [Figure 41-8](#) shows the console message after the bridge-priority command is used to make R2 the root bridge.

Figure 41-8. bridge-priority Command Example

```

FTOS(conf-rstp)#bridge-priority 4096
04:27:59: %RPM0-P:RP2 %SPANMGR-5-STP_ROOT_CHANGE: RSTP root changed. My Bridge ID:
4096:0001.e80b.88bd Old Root: 32768:0001.e801.cbb4 New Root: 4096:0001.e80b.88bd
    
```

↑
↑
Old root bridge ID
New root bridge ID

SNMP Traps for Root Elections and Topology Changes

Enable SNMP traps for RSTP, MSTP, and PVST+ collectively using the command `snmp-server enable traps xstp`.

Fast Hellos for Link State Detection

Fast Hellos for Link State Detection is available only on platform: **S**

Use RSTP Fast Hellos to achieve sub-second link-down detection so that convergence is triggered faster. The standard RSTP link-state detection mechanism does not offer the same low link-state detection speed.

RSTP Fast Hellos decrease the hello interval to the order of milliseconds and all timers derived from the hello timer are adjusted accordingly. This feature does not inter-operate with other vendors, and is available only for RSTP.

| Task | Command Syntax | Command Mode |
|--|---|---------------|
| Configure a hello time on the order of milliseconds. | <code>hello-time milli-second interval</code> Range: 50 - 950 milliseconds | PROTOCOL RSTP |

```

FTOS(conf-rstp)#do show spanning-tree rstp brief
Executing IEEE compatible Spanning Tree Protocol
Root ID      Priority 0, Address 0001.e811.2233
Root Bridge hello time 50 ms, max age 20, forward delay 15
Bridge ID    Priority 0, Address 0001.e811.2233
We are the root
Configured hello time 50 ms, max age 20, forward delay 15
    
```



Note: The hello time is encoded in BPDUs in increments of 1/256ths of a second. The standard minimum hello time in seconds is 1 second, which is encoded as 256. Millisecond hello times are encoded using values less than 256; the millisecond hello time equals $(x/1000)*256$.

Note: When millisecond hellos are configured, the default hello interval of 2 seconds is still used for edge ports; the millisecond hello interval is not used.

Security

Security features are supported on platforms: e C S  

This chapter discusses several ways to provide access security to the Dell Force10 system. Platform-specific features are identified by the C, e or S icons (as shown below).

- [AAA Accounting on page 817](#)
- [AAA Authentication on page 820](#)
- [AAA Authorization on page 823](#)
- [RADIUS on page 828](#)
- [TACACS+ on page 833](#)
- [Protection from TCP Tiny and Overlapping Fragment Attacks on page 837](#)
- [SCP and SSH on page 837](#)
- [Telnet on page 843](#)
- [VTY Line and Access-Class Configuration on page 850](#)
- [Trace Lists on page 844](#)

For details on all commands discussed in this chapter, see the Security Commands chapter in the *FTOS Command Reference*.

AAA Accounting

AAA Accounting is part of the AAA security model (Accounting, Authentication, and Authorization), which includes services for authentication, authorization, and accounting. For details on commands related to AAA security, refer to the Security chapter in the *FTOS Command Reference*.

AAA Accounting enables tracking of services that users are accessing and the amount of network resources being consumed by those services. When AAA Accounting is enabled, the network server reports user activity to the security server in the form of accounting records. Each accounting record is comprised of accounting AV pairs and is stored on the access control server.

As with authentication and authorization, you must configure AAA Accounting by defining a named list of accounting methods and then applying that list to various VTY lines.

Configuration Task List for AAA Accounting

The following sections present the AAA Accounting configuration tasks:

- [Enable AAA Accounting on page 818 \(mandatory\)](#)
- [Suppress AAA Accounting for null username sessions on page 818 \(optional\)](#)
- [Configure Accounting of EXEC and privilege-level command usage on page 819 \(optional\)](#)
- [Configure AAA Accounting for terminal lines on page 819 \(optional\)](#)
- [Monitor AAA Accounting on page 819 \(optional\)](#)

Enable AAA Accounting

The `aaa accounting` command enables you to create a record for any or all of the accounting functions monitored. To enable AAA accounting, perform the following task in CONFIGURATION mode:

| Command Syntax | Command Mode | Purpose |
|--|---------------|---|
| <pre>aaa accounting {system exec command level} {default name} {start-stop wait-start stop-only} {tacacs+}</pre> | CONFIGURATION | <p>Enable AAA Accounting and create a record for monitoring the accounting function.</p> <p>The variables are:</p> <ul style="list-style-type: none"> • <code>system</code>—sends accounting information of any other AAA configuration • <code>exec</code>—sends accounting information when a user has logged in to the EXEC mode • <code>command level</code>—sends accounting of commands executed at the specified privilege level • <code>default name</code>—Enter the name of a list of accounting methods. • <code>start-stop</code>—Use for more accounting information, to send a start-accounting notice at the beginning of the requested event and a stop-accounting notice at the end. • <code>wait-start</code>—ensures that the TACACS+ security server acknowledges the start notice before granting the user's process request • <code>stop-only</code>—Use for minimal accounting; instructs the TACACS+ server to send a stop record accounting notice at the end of the requested user process. • <code>tacacs+</code> —Designate the security service. Currently, FTOS supports only TACACS+ |

Suppress AAA Accounting for null username sessions

When AAA Accounting is activated, the FTOS software issues accounting records for all users on the system, including users whose username string, because of protocol translation, is NULL. An example of this is a user who comes in on a line where the AAA Authentication login method-list none command is applied. To prevent accounting records from being generated for sessions that do not have usernames associated with them, perform the following task in CONFIGURATION mode:

| Command Syntax | Command Mode | Purpose |
|--|---------------|---|
| <pre>aaa accounting suppress null-username</pre> | CONFIGURATION | Prevent accounting records from being generated for users whose username string is NULL |

Configure Accounting of EXEC and privilege-level command usage

The network access server monitors the accounting functions defined in the TACACS+ attribute/value (AV) pairs.

In the following sample configuration, AAA accounting is set to track all usage of EXEC commands and commands on privilege level 15.

```
FTOS(conf)#aaa accounting exec default start-stop tacacs+
FTOS(conf)#aaa accounting command 15 default start-stop tacacs+
```

System accounting can use only the default method list:

```
aaa accounting system default start-stop tacacs+
```

Configure AAA Accounting for terminal lines

Use the following commands to enable accounting with a named method list for a specific terminal line (where com15 and execAcct are the method list names):

```
FTOS(config-line-vty)# accounting commands 15 com15
FTOS(config-line-vty)# accounting exec execAcct
```

Monitor AAA Accounting

FTOS does not support periodic interim accounting, because the periodic command can cause heavy congestion when many users are logged in to the network.

No specific show command exists for TACACS+ accounting. To obtain accounting records displaying information about users currently logged in, perform the following task in Privileged EXEC mode:

| Command Syntax | Command Mode | Purpose |
|-----------------|---------------|---|
| show accounting | CONFIGURATION | Step through all active sessions and print all the accounting records for the actively accounted functions. |

Figure 42-1. show accounting Command Example for AAA Accounting

```
FTOS#show accounting
Active accounted actions on tty2, User admin Priv 1
  Task ID 1, EXEC Accounting record, 00:00:39 Elapsed, service=shell
Active accounted actions on tty3, User admin Priv 1
  Task ID 2, EXEC Accounting record, 00:00:26 Elapsed, service=shell
FTOS#
```

AAA Authentication

FTOS supports a distributed client/server system implemented through Authentication, Authorization, and Accounting (AAA) to help secure networks against unauthorized access. In the Dell Force10 implementation, the Dell Force10 system acts as a RADIUS or TACACS+ client and sends authentication requests to a central RADIUS or TACACS+ server that contains all user authentication and network service access information.

Dell Force10 uses local usernames/passwords (stored on the Dell Force10 system) or AAA for login authentication. With AAA, you can specify the security protocol or mechanism for different login methods and different users. In FTOS, AAA uses a list of authentication methods, called method lists, to define the types of authentication and the sequence in which they are applied. You can define a method list or use the default method list. User-defined method lists take precedence over the default method list.



Note: If a console user logs in with RADIUS authentication, the privilege level will be applied from the RADIUS server if the privilege level is configured for that user in RADIUS whether or not RADIUS authorization is configured.

Configuration Task List for AAA Authentication

The following sections provide the configuration tasks:

- [Configure login authentication for terminal lines](#)
- [Configure AAA Authentication login methods on page 821](#)
- [Enable AAA Authentication on page 822](#)
- [AAA Authentication—RADIUS on page 822](#)

For a complete listing of all commands related to login authentication, refer to the Security chapter in the *FTOS Command Reference*.

Configure login authentication for terminal lines

You can assign up to five authentication methods to a method list. FTOS evaluates the methods in the order in which you enter them in each list. If the first method list does not respond or returns an error, FTOS applies the next method list until the user either passes or fails the authentication. If the user fails a method list, FTOS does not apply the next method list.

Configure AAA Authentication login methods

To configure an authentication method and method list, use these commands in the following sequence in the CONFIGURATION mode:

| Step | Command Syntax | Command Mode | Purpose |
|------|---|---------------|--|
| 1 | <code>aaa authentication login {<i>method-list-name</i> default} <i>method1</i> [... <i>method4</i>]</code> | CONFIGURATION | Define an authentication method-list (<i>method-list-name</i>) or specify the default. The default method-list is applied to all terminal lines. Possible methods are: <ul style="list-style-type: none">• enable—use the password defined by the enable secret or enable password command in the CONFIGURATION mode.• line—use the password defined by the password command in the LINE mode.• local—use the username/password database defined in the local configuration.• none—no authentication.• radius—use the RADIUS server(s) configured with the radius-server host command.• tacacs+—use the TACACS+ server(s) configured with the tacacs-server host command |
| 2 | <code>line {aux 0 console 0 vty <i>number</i> [... <i>end-number</i>]}</code> | CONFIGURATION | Enter the LINE mode. |
| 3 | <code>login authentication {<i>method-list-name</i> default}</code> | LINE | Assign a <i>method-list-name</i> or the default list to the terminal line. |

FTOS Behavior: If you use a method list on the console port in which RADIUS or TACACS is the last authentication method, and the server is not reachable, FTOS allows access even though the username and password credentials cannot be verified. Only the console port behaves this way, and does so to ensure that users are not locked out of the system in the event that network-wide issue prevents access to these servers.

To view the configuration, use the `show config` command in the LINE mode or the `show running-config` in the EXEC Privilege mode.



Note: Dell Force10 recommends that you use the **none** method only as a backup. This method does not authenticate users. The **none** and **enable** methods do not work with SSH.

You can create multiple method lists and assign them to different terminal lines.

Enable AAA Authentication

To enable AAA authentication, use the following command in the CONFIGURATION mode:

| Command Syntax | Command Mode | Purpose |
|---|---------------|---|
| <pre>aaa authentication enable {method-list-name default} method1 [... method4]</pre> | CONFIGURATION | <ul style="list-style-type: none"> default—Uses the listed authentication methods that follow this argument as the default list of methods when a user logs in. method-list-name—Character string used to name the list of enable authentication methods activated when a user logs in. method1 [... method4]—Any of the following: RADIUS, TACACS, enable, line, none. |

If the default list is not set, only the local enable is checked. This has the same effect as issuing:

```
aaa authentication enable default enable
```

AAA Authentication—RADIUS

To enable authentication from the RADIUS server, and use TACACS as a backup, use the following commands:

| Step | Command Syntax | Command Mode | Purpose |
|------|--|---------------|--|
| 1 | <pre>aaa authentication enable default radius tacacs</pre> | CONFIGURATION | To enable RADIUS and to set up TACACS as backup. |
| 2 | <pre>radius-server host x.x.x.x key some-password</pre> | CONFIGURATION | To establish host address and password. |
| 3 | <pre>tacacs-server host x.x.x.x key some-password</pre> | CONFIGURATION | To establish host address and password. |

To get enable authentication from the RADIUS server, and use TACACS as a backup, issue the following commands:

```
FTOS(config)# aaa authentication enable default radius tacacs
Radius and TACACS server has to be properly setup for this.
FTOS(config)# radius-server host x.x.x.x key <some-password>
FTOS(config)# tacacs-server host x.x.x.x key <some-password>
```

To use local authentication for enable secret on console, while using remote authentication on VTY lines, perform the following steps:

```
FTOS(config)# aaa authentication enable mymethodlist radius tacacs
FTOS(config)# line vty 0 9
FTOS(config-line-vty)# enable authentication mymethodlist
```

Server-side configuration

TACACS+: When using TACACS+, Dell Force10 sends an initial packet with service type SVC_ENABLE, and then, a second packet with just the password. The TACACS server must have an entry for username \$enable\$.

RADIUS: When using RADIUS authentication, FTOS sends an authentication packet with the following:

```
Username: $enab15$  
Password: <password-entered-by-user>
```

Therefore, the RADIUS server must have an entry for this username.

AAA Authorization

FTOS enables AAA new-model by default. You can set authorization to be either local or remote. Different combinations of authentication and authorization yield different results. By default, FTOS sets both to local.

Privilege Levels Overview

Limiting access to the system is one method of protecting the system and your network. However, at times, you might need to allow others access to the router and you can limit that access to a subset of commands. In FTOS, you can configure a privilege level for users who need limited access to the system.

Every command in FTOS is assigned a privilege level of 0, 1 or 15. You can configure up to 16 privilege levels in FTOS. FTOS is pre-configured with 3 privilege levels and you can configure 13 more. The three pre-configured levels are:

- **Privilege level 1**—is the default level for the EXEC mode. At this level, you can interact with the router, for example, view some show commands and Telnet and ping to test connectivity, but you cannot configure the router. This level is often called the “user” level. One of the commands available in Privilege level 1 is the enable command, which you can use to enter a specific privilege level.
- **Privilege level 0**—contains only the end, enable and disable commands.
- **Privilege level 15**—the default level for the enable command, is the highest level. In this level you can access any command in FTOS.

Privilege levels 2 through 14 are not configured and you can customize them for different users and access.

After you configure other privilege levels, enter those levels by adding the level parameter after the enable command or by configuring a user name or password that corresponds to the privilege level. Refer to [Configure a username and password on page 824](#) for more information on configuring user names.

By default, commands in FTOS are assigned to different privilege levels. You can access those commands only if you have access to that privilege level. For example, to reach the protocol spanning-tree command, you must log in to the router, enter the enable command for privilege level 15 (this is the default level for the command) and then enter the CONFIGURATION mode.

You can configure passwords to control access to the box and assign different privilege levels to users. FTOS supports the use of passwords when you log in to the system and when you enter the enable command. If you move between privilege levels, you are prompted for a password if you move to a higher privilege level.

Configuration Task List for Privilege Levels

The following list has the configuration tasks for privilege levels and passwords.

- [Configure a username and password on page 824](#) (mandatory)
- [Configure the enable password command on page 825](#) (mandatory)
- [Configure custom privilege levels on page 825](#) (mandatory)
- [Specify LINE mode password and privilege on page 827](#) (optional)
- [Enable and disabling privilege levels on page 828](#) (optional)

For a complete listing of all commands related to FTOS privilege levels and passwords, refer to the Security chapter in the *FTOS Command Reference*.

Configure a username and password

In FTOS, you can assign a specific username to limit user access to the system.

To configure a username and password, use the following command in the CONFIGURATION mode:

| Command Syntax | Command Mode | Purpose |
|---|---------------|---|
| username <i>name</i> [access-class <i>access-list-name</i>] [nopassword password [encryption-type] <i>password</i>] [privilege <i>level</i>] | CONFIGURATION | Assign a user name and password. Configure the optional and required parameters: <ul style="list-style-type: none"> • <i>name</i>: Enter a text string up to 63 characters long. • access-class <i>access-list-name</i>: Enter the name of a configured IP ACL. • nopassword: Do not require the user to enter a password. • encryption-type: Enter 0 for plain text or 7 for encrypted text. • <i>password</i>: Enter a string. • privilege <i>level</i> range: 0 to 15. |

To view usernames, use the show users command in the EXEC Privilege mode.

Configure the enable password command

To configure FTOS, you must use the enable command to enter the EXEC Privilege level 15. After entering the command, FTOS requests that you enter a password. Privilege levels are not assigned to passwords, rather passwords are assigned to a privilege level. A password for any privilege level can always be changed. To change to a different privilege level, enter the enable command, followed by the privilege level. If you do not enter a privilege level, the default level 15 is assumed.

To configure a password for a specific privilege level, use the following command in the CONFIGURATION mode:

| Command Syntax | Command Mode | Purpose |
|--|---------------|---|
| <code>enable password [level <i>level</i>] [<i>encryption-mode</i>] <i>password</i></code> | CONFIGURATION | <p>Configure a password for a privilege level. Configure the optional and required parameters:</p> <ul style="list-style-type: none">• <i>level level</i>: Specify a level 0 to 15. Level 15 includes all levels.• <i>encryption-type</i>: Enter 0 for plain text or 7 for encrypted text.• <i>password</i>: Enter a string. <p>To change only the password for the enable command, configure only the <i>password</i> parameter.</p> |

To view the configuration for the enable secret command, use the show running-config command in the EXEC Privilege mode.

In custom-configured privilege levels, the enable command is always available. No matter what privilege level you entered FTOS, you can enter the enable 15 command to access and configure all CLI.

Configure custom privilege levels

In addition to assigning privilege levels to the user, you can configure the privilege levels of commands so that they are visible in different privilege levels. Within FTOS, commands have certain privilege levels. With the privilege command, the default level can be changed or you can reset their privilege level back to the default.

- Assign the launch keyword (for example, configure) for the keyword's command mode.
- If you assign only the first keyword to the privilege level, all commands beginning with that keyword are also assigned to the privilege level. If you enter the entire command, the software assigns the privilege level to that command only.

To assign commands and passwords to a custom privilege level, you must be in privilege level 15 and use these commands in the following sequence in the CONFIGURATION mode:

| Step | Command Syntax | Command Mode | Purpose |
|------|---|---------------|--|
| 1 | username <i>name</i> [access-class <i>access-list-name</i>] [privilege <i>level</i>] [nopassword password [<i>encryption-type</i>] <i>password</i>] | CONFIGURATION | Assign a user name and password. Configure the optional and required parameters: <ul style="list-style-type: none"> <i>name</i>: Enter a text string (up to 63 characters). access-class <i>access-list-name</i>: Enter the name of a configured IP ACL. privilege <i>level</i> range: 0 to 15. nopassword: Do not require the user to enter a password. <i>encryption-type</i>: Enter 0 for plain text or 7 for encrypted text. <i>password</i>: Enter a string. |
| 2 | enable password [level <i>level</i>] [<i>encryption-mode</i>] <i>password</i> | CONFIGURATION | Configure a password for privilege level. Configure the optional and required parameters: <ul style="list-style-type: none"> level <i>level</i>: Specify a level 0 to 15. Level 15 includes all levels. <i>encryption-type</i>: Enter 0 for plain text or 7 for encrypted text. <i>password</i>: Enter a string up to 25 characters long. <p>To change only the password for the enable command, configure only the <i>password</i> parameter.</p> |
| 3 | privilege <i>mode</i> {level <i>level</i> <i>command</i> reset <i>command</i> } | CONFIGURATION | Configure level and commands for a mode or reset a command's level. Configure the following required and optional parameters: <ul style="list-style-type: none"> <i>mode</i>: Enter a keyword for the modes (exec, configure, interface, line, route-map, router) level <i>level</i> range: 0 to 15. Levels 0, 1 and 15 are pre-configured. Levels 2 to 14 are available for custom configuration. <i>command</i>: A FTOS CLI keyword (up to 5 keywords allowed). reset: Return the command to its default privilege mode. |

To view the configuration, use the show running-config command in the EXEC Privilege mode.

Figure 42-2 is an example of a configuration to allow a user “john” to view only the EXEC mode commands and all snmp-server commands. Since the snmp-server commands are “enable” level commands and, by default, found in the CONFIGURATION mode, you must also assign the launch command for the CONFIGURATION mode, configure, to the same privilege level as the snmp-server commands.

Figure 42-2. Configuring a Custom Privilege Level

```
FTOS(conf)#username john privilege 8 password john
FTOS(conf)#enable password level 8 notjohn
FTOS(conf)#privilege exec level 8 configure
FTOS(conf)#privilege config level 8 snmp-server
FTOS(conf)#end
FTOS#show running-config
Current Configuration ...
!
hostname Force10
!
enable password level 8 notjohn
enable password Force10
!
username admin password 0 admin
username john password 0 john privilege 8
!
```

← The user john is assigned privilege level 8 and assigned a password.
← All other users are assigned a password to access privilege level 8
← The command configure is assigned to privilege level 8 since it is needed to reach the CONFIGURATION mode where the snmp-server commands are located.
← The snmp-server commands, in the CONFIGURATION mode, are assigned to privilege level 8.

Figure 42-3 is a screen shot of the Telnet session for user “john”. The show privilege command output confirms that “john” is in privilege level 8. In the EXEC Privilege mode, “john” can access only the commands listed. In CONFIGURATION mode, “john” can access only the snmp-server commands.

Figure 42-3. User john’s Login and the List of Available Commands

```
apollo% telnet 172.31.1.53
Trying 172.31.1.53...
Connected to 172.31.1.53.
Escape character is '^]'.
Login: john
Password:
FTOS#show priv
Current privilege level is 8
FTOS#?
configure          Configuring from terminal
disable            Turn off privileged commands
enable             Turn on privileged commands
exit               Exit from the EXEC
no                 Negate a command
show               Show running system information
terminal           Set terminal line parameters
traceroute         Trace route to destination
FTOS#confi
FTOS(conf)#?
end                Exit from Configuration mode
exit               Exit from Configuration mode
no                 Reset a command
snmp-server        Modify SNMP parameters
FTOS(conf)#
```

Specify LINE mode password and privilege

You can specify a password authentication of all users on different *terminal* lines. The user’s privilege level will be the same as the privilege level assigned to the terminal line, unless a more specific privilege level is assigned to the user.

To specify a password for the terminal line, use the following commands, in any order, in the LINE mode:

| Command Syntax | Command Mode | Purpose |
|--|--------------|--|
| <code>privilege level <i>level</i></code> | LINE | Configure a custom privilege level for the terminal lines. <ul style="list-style-type: none"> <i>level level</i> range: 0 to 15. Levels 0, 1 and 15 are pre-configured. Levels 2 to 14 are available for custom configuration. |
| <code>password [<i>encryption-type</i>] <i>password</i></code> | LINE | Specify either a plain text or encrypted password. Configure the following optional and required parameters: <ul style="list-style-type: none"> <i>encryption-type</i>: Enter 0 for plain text or 7 for encrypted text. <i>password</i>: Enter a text string up to 25 characters long. |

To view the password configured for a terminal, use the `show config` command in the LINE mode.

Enable and disabling privilege levels

Enter the `enable` or `enable privilege-level` command in the EXEC Privilege mode to set a user's security level. If you do not enter a privilege level, FTOS sets it to 15 by default.

To move to a lower privilege level, enter the `disable` command followed by the level-number you wish to set for the user in the EXEC Privilege mode. If you enter `disable` without a level-number, your security level is 1.

RADIUS

Remote Authentication Dial-In User Service (RADIUS) is a distributed client/server protocol. This protocol transmits authentication, authorization, and configuration information between a central RADIUS server and a RADIUS client (the Dell Force10 system). The system sends user information to the RADIUS server and requests authentication of the user and password. The RADIUS server returns one of the following responses:

- **Access-Accept**—the RADIUS server authenticates the user
- **Access-Reject**—the RADIUS server does not authenticate the user

If an error occurs in the transmission or reception of RADIUS packets, the error can be viewed by enabling the `debug radius` command.

Transactions between the RADIUS server and the client are encrypted (the users' passwords are not sent in plain text). RADIUS uses UDP as the transport protocol between the RADIUS server host and the client.

For more information on RADIUS, refer to RFC 2865, *Remote Authentication Dial-in User Service*.

RADIUS Authentication and Authorization

FTOS supports RADIUS for user authentication (text password) at login and can be specified as one of the login authentication methods in the `aaa authentication login` command.

When configuring AAA authorization, you can configure to limit the attributes of services available to a user. When authorization is enabled, the network access server uses configuration information from the user profile to issue the user's session. The user's access is limited based on the configuration attributes.

RADIUS `exec-authorization` stores a user-shell profile and that is applied during user login. You may name the relevant named-lists with either a unique name or the default name. When authorization is enabled by the RADIUS server, the server returns the following information to the client:

- Idle time
- ACL configuration information
- Auto-command
- Privilege level

After gaining authorization for the first time, you may configure these attributes.



Note: RADIUS authentication/authorization is done for every login. There is no difference between first-time login and subsequent logins.

Idle Time

Every session line has its own idle-time. If the idle-time value is not changed, the default value of 30 minutes is used. RADIUS specifies idle-time allow for a user during a session before timeout. When a user logs in, the lower of the two idle-time values (configured or default) is used. The idle-time value is updated if both of the following happens:

- The administrator changes the idle-time of the line on which the user has logged in
- The idle-time is lower than the RADIUS-returned idle-time

ACL

The RADIUS server can specify an ACL. If an ACL is configured on the RADIUS server, and if that ACL is present, user may be allowed access based on that ACL. If the ACL is absent, authorization fails, and a message is logged indicating the this.

RADIUS can specify an ACL for the user if both of the following are true:

- If an ACL is absent
- There is a very long delay for an entry, or a denied entry because of an ACL, and a message is logged



Note: The ACL name must be a string. Only standard ACLs in authorization (both RADIUS and TACACS) are supported. Authorization is denied in cases using Extended ACLs.

Auto-command

You can configure the system through the RADIUS server to automatically execute a command when you connect to a specific line. To do this, use the command `auto-command`. The auto-command is executed when the user is authenticated and before the prompt appears to the user.

Set access to privilege levels through RADIUS

Through the RADIUS server, you can use the command `privilege level` to configure a privilege level for the user to enter into when they connect to a session. This value is configured on the client system.

Configuration Task List for RADIUS

To authenticate users using RADIUS, at least one RADIUS server must be specified so that the system can communicate with and configure RADIUS as one of your authentication methods.

The following list includes the configuration tasks for RADIUS.

- [Define a aaa method list to be used for RADIUS on page 830](#) (mandatory)
- [Apply the method list to terminal lines on page 831](#) (mandatory except when using default lists)
- [Specify a RADIUS server host on page 831](#) (mandatory)
- [Set global communication parameters for all RADIUS server hosts on page 832](#) (optional)
- [Monitor RADIUS on page 833](#) (optional)

For a complete listing of all FTOS commands related to RADIUS, refer to the Security chapter in the *FTOS Command Reference*.



Note: RADIUS authentication and authorization are done in a single step. Hence, authorization cannot be used independent of authentication. However, if RADIUS authorization is configured and authentication is not, then a message is logged stating this. During authorization, the next method in the list (if present) is used, or if another method is not present, an error is reported.

To view the configuration, use the `show config` in the LINE mode or the `show running-config` command in the EXEC Privilege mode.

Define a AAA method list to be used for RADIUS

To configure RADIUS to authenticate or authorize users on the system, you must create a AAA method list. Default method lists do not need to be explicitly applied to the line, so they are not mandatory. To create a method list, enter one of the following commands in CONFIGURATION mode:

| Command Syntax | Command Mode | Purpose |
|---|---------------|--|
| <code>aaa authentication login method-list-name radius</code> | CONFIGURATION | Enter a text string (up to 16 characters long) as the name of the method list you wish to use with the RADIUS authentication method. |

| Command Syntax | Command Mode | Purpose |
|--|---------------|--|
| aaa authorization exec { <i>method-list-name</i> default} radius tacacs+ | CONFIGURATION | Create methodlist with RADIUS and TACACS+ as authorization methods. Typical order of methods: RADIUS, TACACS+, Local, None. If authorization is denied by RADIUS, the session ends (radius should not be the last method specified). |

Apply the method list to terminal lines

To enable RADIUS AAA login authentication for a method list, you must apply it to a terminal line. To configure a terminal line for RADIUS authentication and authorization, enter the following commands:

| Command Syntax | Command Mode | Purpose |
|---|---------------|---|
| line {aux 0 console 0 vty <i>number</i> [<i>end-number</i>]} | CONFIGURATION | Enter the LINE mode. |
| login authentication { <i>method-list-name</i> default} | LINE | Enable AAA login authentication for the specified RADIUS method list. This procedure is mandatory if you are not using default lists. |
| authorization exec <i>methodlist</i> | CONFIGURATION | To use the methodlist. |

Specify a RADIUS server host

When configuring a RADIUS server host, you can set different communication parameters, such as the UDP port, the key password, the number of retries, and the timeout.

To specify a RADIUS server host and configure its communication parameters, use the following command in the CONFIGURATION mode:

| Command Syntax | Command Mode | Purpose |
|---|---------------|--|
| radius-server host { <i>hostname</i> <i>ip-address</i> } [auth-port <i>port-number</i>] [retransmit <i>retries</i>] [timeout <i>seconds</i>] [key [<i>encryption-type</i>] <i>key</i>] | CONFIGURATION | <p>Enter the host name or IP address of the RADIUS server host. Configure the optional communication parameters for the specific host:</p> <ul style="list-style-type: none"> auth-port <i>port-number</i> range: 0 to 65335. Enter a UDP port number. The default is 1812. retransmit <i>retries</i> range: 0 to 100. Default is 3. timeout <i>seconds</i> range: 0 to 1000. Default is 5 seconds. key [<i>encryption-type</i>] <i>key</i>: Enter 0 for plain text or 7 for encrypted text, and a string for the key. The key can be up to 42 characters long. This key must match the key configured on the RADIUS server host. <p>If these optional parameters are not configured, the global default values for all RADIUS host are applied.</p> |

To specify multiple RADIUS server hosts, configure the radius-server host command multiple times. If multiple RADIUS server hosts are configured, FTOS attempts to connect with them in the order in which they were configured. When FTOS attempts to authenticate a user, the software connects with the RADIUS server hosts one at a time, until a RADIUS server host responds with an accept or reject response.

If you want to change an optional parameter setting for a specific host, use the radius-server host command. To change the global communication settings to all RADIUS server hosts, refer to [Set global communication parameters for all RADIUS server hosts on page 832](#).

To view the RADIUS configuration, use the show running-config radius command in the EXEC Privilege mode.

To delete a RADIUS server host, use the no radius-server host *{hostname | ip-address}* command.

Set global communication parameters for all RADIUS server hosts

You can configure global communication parameters (auth-port, key, retransmit, and timeout parameters) and specific host communication parameters on the same system. However, if both global and specific host parameters are configured, the specific host parameters override the global parameters for that RADIUS server host.

To set global communication parameters for all RADIUS server hosts, use any or all of the following commands in the CONFIGURATION mode:

| Command Syntax | Command Mode | Purpose |
|---|---------------|--|
| radius-server deadtime <i>seconds</i> | CONFIGURATION | Set a time interval after which a RADIUS host server is declared dead. <ul style="list-style-type: none"> <i>seconds</i> range: 0 to 2147483647. Default: 0 seconds |
| radius-server key [<i>encryption-type</i>] <i>key</i> | CONFIGURATION | Configure a key for all RADIUS communications between the system and RADIUS server hosts. <ul style="list-style-type: none"> <i>encryption-type</i>: Enter 7 to encrypt the password. Enter 0 to keep the password as plain text. <i>key</i>: Enter a string. The key can be up to 42 characters long. You cannot use spaces in the key. |
| radius-server retransmit <i>retries</i> | CONFIGURATION | Configure the number of times FTOS retransmits RADIUS requests. <ul style="list-style-type: none"> <i>retries</i> range: 0 to 100. Default is 3 retries. |
| radius-server timeout <i>seconds</i> | CONFIGURATION | Configure the time interval the system waits for a RADIUS server host response. <ul style="list-style-type: none"> <i>seconds</i> range: 0 to 1000. Default is 5 seconds. |

To view the configuration of RADIUS communication parameters, use the `show running-config` command in the EXEC Privilege mode.

Monitor RADIUS

To view information on RADIUS transactions, use the following command in the EXEC Privilege mode:

| Command Syntax | Command Mode | Purpose |
|---------------------------|----------------|--|
| <code>debug radius</code> | EXEC Privilege | View RADIUS transactions to troubleshoot problems. |

TACACS+

FTOS supports Terminal Access Controller Access Control System (TACACS+ client, including support for login authentication.

Configuration Task List for TACACS+

The following list includes the configuration task for TACACS+ functions:

- [Choose TACACS+ as the Authentication Method](#)
- [Monitor TACACS+](#)
- [TACACS+ Remote Authentication and Authorization on page 835](#)
- [TACACS+ Remote Authentication and Authorization on page 835](#)
- [Specify a TACACS+ server host on page 836](#)
- [Choose TACACS+ as the Authentication Method on page 833](#)

For a complete listing of all commands related to TACACS+, refer to the Security chapter in the *FTOS Command Reference*.

Choose TACACS+ as the Authentication Method

One of the login authentication methods available is TACACS+ and the user's name and password are sent for authentication to the TACACS hosts specified. To use TACACS+ to authenticate users, you must specify at least one TACACS+ server for the system to communicate with and configure TACACS+ as one of your authentication methods.

To select TACACS as the login authentication method, use these commands in the following sequence in the CONFIGURATION mode:

| Step | Command Syntax | Command Mode | Purpose |
|------|---|---------------|---|
| 1 | <code>tacacs-server host {<i>ip-address</i> <i>host</i>}</code> | CONFIGURATION | Configure a TACACS+ server host. Enter the IP address or host name of the TACACS+ server. Use this command multiple times to configure multiple TACACS+ server hosts. |
| 2 | <code>aaa authentication login {<i>method-list-name</i> default} tacacs+ [...<i>method3</i>]</code> | CONFIGURATION | Enter a text string (up to 16 characters long) as the name of the method list you wish to use with the TACAS+ authentication method The <code>tacacs+</code> method should not be the last method specified. |
| 3 | <code>line {aux 0 console 0 vty <i>number</i> [<i>end-number</i>]}</code> | CONFIGURATION | Enter the LINE mode. |
| 4 | <code>login authentication {<i>method-list-name</i> default}</code> | LINE | Assign the <i>method-list</i> to the terminal line. |

To view the configuration, use the `show config` in the LINE mode or the `show running-config tacacs+` command in the EXEC Privilege mode.

If authentication fails using the primary method, FTOS employs the second method (or third method, if necessary) automatically. For example, if the TACACS+ server is reachable, but the server key is invalid, FTOS proceeds to the next authentication method. In [Figure 42-4](#), the TACACS+ is incorrect, but the user is still authenticated by the secondary method.

Figure 42-4. Failed Authentication

```
FTOS(conf)#
FTOS(conf)#do show run aaa
!
aaa authentication enable default tacacs+ enable
aaa authentication enable LOCAL enable tacacs+
aaa authentication login default tacacs+ local
aaa authentication login LOCAL local tacacs+
aaa authorization exec default tacacs+ none
aaa authorization commands 1 default tacacs+ none
aaa authorization commands 15 default tacacs+ none
aaa accounting exec default start-stop tacacs+
aaa accounting commands 1 default start-stop tacacs+
aaa accounting commands 15 default start-stop tacacs+
FTOS(conf)#
FTOS(conf)#do show run tacacs+
!
tacacs-server key 7 d05206c308f4d35b Server key purposely changed to incorrect value
tacacs-server host 10.10.10.10 timeout 1
FTOS(conf)#tacacs-server key angelina
FTOS(conf) #%RPM0-P:CP %SEC-5-LOGIN_SUCCESS: Login successful for user admin on
vty0 (10.11.9.209)
  %RPM0-P:CP %SEC-3-AUTHENTICATION_ENABLE_SUCCESS: Enable password
authentication success on vty0 ( 10.11.9.209 )
  %RPM0-P:CP %SEC-5-LOGOUT: Exec session is terminated for user admin on line
vty0 (10.11.9.209)
FTOS(conf)#username angeline password angeline
FTOS(conf) #%RPM0-P:CP %SEC-5-LOGIN_SUCCESS: Login successful for user angeline
on vty0 (10.11.9.209)
  %RPM0-P:CP %SEC-3-AUTHENTICATION_ENABLE_SUCCESS: Enable password
authentication success on vty0 ( 10.11.9.209 ) User authenticated using secondary method
```

Monitor TACACS+

To view information on TACACS+ transactions, use the following command in the EXEC Privilege mode:

| Command Syntax | Command Mode | Purpose |
|----------------|----------------|---|
| debug tacacs+ | EXEC Privilege | View TACACS+ transactions to troubleshoot problems. |

TACACS+ Remote Authentication and Authorization

FTOS takes the access class from the TACACS+ server. Access class is the class of service that restricts Telnet access and packet sizes. If you have configured remote authorization, then FTOS ignores the access class you have configured for the VTY line. FTOS instead gets this access class information from the TACACS+ server. FTOS needs to know the username and password of the incoming user before it can fetch the access class from the server. A user, therefore, will at least see the login prompt. If the access class denies the connection, FTOS closes the Telnet session immediately.

Figure 42-5 demonstrates how to configure the access-class from a TACACS+ server. This causes the configured access-class on the VTY line to be ignored. If you have configured a deny10 ACL on the TACACS+ server, FTOS downloads it and applies it. If the user is found to be coming from the 10.0.0.0 subnet, FTOS also immediately closes the Telnet connection. Note, that no matter where the user is coming from, they see the login prompt.

Figure 42-5. Specify a TACACS+ server host

```
FTOS#
FTOS(conf)#
FTOS(conf)#ip access-list standard deny10
FTOS(conf-std-nacl)#permit 10.0.0.0/8
FTOS(conf-std-nacl)#deny any
FTOS(conf)#
FTOS(conf)#aaa authentication login tacacsmethod tacacs+
FTOS(conf)#aaa authentication exec tacacsauthorization tacacs+
FTOS(conf)#tacacs-server host 25.1.1.2 key Force10
FTOS(conf)#
FTOS(conf)#line vty 0 9
FTOS(config-line-vty)#login authentication tacacsmethod
FTOS(config-line-vty)#authorization exec tacacauthor
FTOS(config-line-vty)#
FTOS(config-line-vty)#access-class deny10
FTOS(config-line-vty)#end
```

When configuring a TACACS+ server host, you can set different communication parameters, such as the key password.

To specify a TACACS+ server host and configure its communication parameters, use the following command in the CONFIGURATION mode:

| Command Syntax | Command Mode | Purpose |
|--|---------------|---|
| <code>tacacs-server host {hostname ip-address} [port port-number] [timeout seconds] [key key]</code> | CONFIGURATION | <p>Enter the host name or IP address of the TACACS+ server host. Configure the optional communication parameters for the specific host:</p> <ul style="list-style-type: none"> <code>port port-number</code> range: 0 to 65335. Enter a TCP port number. The default is 49. <code>timeout seconds</code> range: 0 to 1000. Default is 10 seconds. <code>key key</code>: Enter a string for the key. The key can be up to 42 characters long. This key must match a key configured on the TACACS+ server host. This parameter should be the last parameter configured. <p>If these optional parameters are not configured, the default global values are applied.</p> |

To specify multiple TACACS+ server hosts, configure the `tacacs-server host` command multiple times. If multiple TACACS+ server hosts are configured, FTOS attempts to connect with them in the order in which they were configured.

To view the TACACS+ configuration, use the `show running-config tacacs+` command in the EXEC Privilege mode.

To delete a TACACS+ server host, use the `no tacacs-server host {hostname | ip-address}` command.

```
freebsd2# telnet 2200:2200:2200:2200:2200::2202
Trying 2200:2200:2200:2200:2200::2202...
Connected to 2200:2200:2200:2200:2200::2202.
Escape character is '^]'.
Login: admin
Password:
FTOS#
FTOS#
```

Command Authorization

The AAA command authorization feature configures FTOS to send each configuration command to a TACACS server for authorization before it is added to the running configuration.

By default, the AAA authorization commands configure the system to check both EXEC mode and CONFIGURATION mode commands. Use the command `no aaa authorization config-commands` to enable only EXEC mode command checking.

If rejected by the AAA server, the command is not added to the running config, and messages similar to [Message 1](#) are displayed.

Message 1 Configuration Command Rejection

```
04:07:48: %RPM0-P:CP %SEC-3-SEC_AUTHORIZATION_FAIL: Authorization failure Command
authorization failed for user (denyall) on vty0 ( 10.11.9.209 )
```

Protection from TCP Tiny and Overlapping Fragment Attacks

Tiny and overlapping fragment attack is a class of attack where configured ACL entries—denying TCP port-specific traffic—can be bypassed, and traffic can be sent to its destination although denied by the ACL. RFC 1858 and 3128 proposes a countermeasure to the problem. This countermeasure is configured into the line cards and enabled by default.

SCP and SSH

Secure Shell (SSH) is a protocol for secure remote login and other secure network services over an insecure network. FTOS is compatible with SSH versions 1.5 and 2, both the client and server modes. SSH sessions are encrypted and use authentication. For details on command syntax, see the Security chapter in the *FTOS Command Line Interface Reference*.

SCP is a remote file copy program that works with SSH and is supported by FTOS.



Note: The Windows-based WinSCP client software is not supported for secure copying between a PC and an FTOS-based system. Unix-based SCP client software is supported.

To use the SSH client, use the following command in the EXEC Privilege mode:

| Command Syntax | Command Mode | Purpose |
|---|----------------|---|
| ssh { <i>hostname</i> } [-l <i>username</i> -p <i>port-number</i> -v {1 2}] | EXEC Privilege | Open an SSH connection specifying the hostname, username, port number, and version of the SSH client. <i>hostname</i> is the IP address or hostname of the remote device. <ul style="list-style-type: none"> Enter an IPv4 or IPv6 address in dotted decimal format (A.B.C.D). |

To enable the SSH server for version 1 and 2, use the following command in the CONFIGURATION mode:

| Command Syntax | Command Mode | Purpose |
|---|---------------|---|
| ip ssh server {enable port <i>port-number</i> } | CONFIGURATION | Configure the Dell Force10 system as an SCP/SSH server. |

To enable the SSH server for version 1 or 2 only, use the following command:

| Command Syntax | Command Mode | Purpose |
|-----------------------------|---------------|---|
| ip ssh server version {1 2} | CONFIGURATION | Configure the Dell Force10 system as an SSH server that uses only version 1 or 2. |

To view the SSH configuration, use the following command in EXEC Privilege mode:

| Command Syntax | Command Mode | Purpose |
|----------------|----------------|-------------------------------------|
| show ip ssh | EXEC Privilege | Display SSH connection information. |

Figure 42-6 shows the use of the command ip ssh server version 2 to enable SSH version 2, and the show ip ssh command to confirm the setting.

Figure 42-6. Specifying an SSH version

```
FTOS(conf)#ip ssh server version 2
FTOS(conf)#do show ip ssh
SSH server          : disabled.
SSH server version  : v2.
Password Authentication : enabled.
Hostbased Authentication : disabled.
RSA Authentication  : disabled.
```

To disable SSH server functions, enter `no ip ssh server enable`.

Using SCP with SSH to copy a software image

To use Secure Copy (SCP) to copy a software image through an SSH connection from one switch to another, use the following procedure:

| Step | Task | Command Syntax | Command Mode |
|------|---|---|----------------|
| 1 | On Chassis One, set the SSH port number (port 22 by default). | <code>ip ssh server port <i>number</i></code> | CONFIGURATION |
| 2 | On Chassis One, enable SSH. | <code>ip ssh server enable</code> | CONFIGURATION |
| 3 | On Chassis Two, invoke SCP. | <code>copy scp: flash:</code> | CONFIGURATION |
| 4 | On Chassis Two, in response to prompts, enter the path to the desired file and enter the port number specified in Step 1. | | EXEC Privilege |

This example shows the use of SCP and SSH to copy a software image from one switch running SSH Server on UDP port 99 to the local switch:

Figure 42-7. Using SCP to copy from an SSH Server on another Switch

```
FTOS#copy scp: flash:
Address or name of remote host []: 10.10.10.1
Port number of the server [22]: 99
Source file name []: test.cfg
User name to login remote host: admin
Password to login remote host:
```

Other SSH-related commands include:

- `crypto key generate`: Generate keys for the SSH server.
- `debug ip ssh`: Enables collecting SSH debug information.
- `ip scp topdir`: Identify a location for files used in secure copy transfer.
- `ip ssh authentication-retries`: Configure the maximum number of attempts that should be used to authenticate a user.
- `ip ssh connection-rate-limit`: Configure the maximum number of incoming SSH connections per minute.

- `ip ssh hostbased-authentication enable`: Enable hostbased-authentication for the SSHv2 server.
- `ip ssh key-size`: Configure the size of the server-generated RSA SSHv1 key.
- `ip ssh password-authentication enable`: Enable password authentication for the SSH server.
- `ip ssh pub-key-file`: Specify the file to be used for host-based authentication.
- `ip ssh rhostsfile`: Specify the rhost file to be used for host-based authorization.
- `ip ssh rsa-authentication enable`: Enable RSA authentication for the SSHv2 server.
- `ip ssh rsa-authentication`: Add keys for the RSA authentication.
- `show crypto`: Display the public part of the SSH host-keys.
- `show ip ssh client-pub-keys`: Display the client public keys used in host-based authentication.
- `show ip ssh rsa-authentication`: Display the authorized-keys for the RSA authentication.
- `ssh-peer-rpm`: Open an SSH connection to the peer RPM.

Secure Shell Authentication

Secure Shell (SSH) is disabled by default. Enable it using the command `ip ssh server enable`.

SSH supports three methods of authentication:

- [SSH Authentication by Password on page 840](#)
- [RSA Authentication of SSH on page 841](#)
- [Host-based SSH Authentication on page 841](#)

Important Points to Remember for SSH Authentication

- If more than one method is enabled, the order in which the methods are preferred is based on the `ssh_config` file on the Unix machine.
- When all the three authentication methods are enabled, password authentication is the backup method when the RSA method fails.
- The files `known_hosts` and `known_hosts2` are generated when a user tries to SSH using version 1 or version 2, respectively.

SSH Authentication by Password

Authenticate an SSH client by prompting for a password when attempting to connect to the Dell Force10 system. This is the simplest methods of authentication and uses SSH version 1.

Enable SSH password authentication using the command `ip ssh password-authentication enable` from CONFIGURATION mode. View your SSH configuration using the command `show ip ssh` from EXEC Privilege mode.

Figure 42-8. Enabling SSH Password Authentication

```
FTOS(conf)#ip ssh server enable
                % Please wait while SSH Daemon initializes ... done.
FTOS(conf)#ip ssh password-authentication enable
FTOS#sh ip ssh
SSH server      : enabled.
Password Authentication : enabled.
Hostbased Authentication : disabled.
RSA Authentication : disabled.
```

RSA Authentication of SSH

The following procedure authenticates an SSH client based on an RSA key using RSA authentication. This method uses SSH version 2:

| Step | Task | Command Syntax | Command Mode |
|------|--|---|----------------|
| 1 | On the SSH client (Unix machine), generate an RSA key, as shown in Figure 42-9 . | | |
| | Figure 42-9. Generating RSA Keys | | |
| | <pre>admin@Unix_client#ssh-keygen -t rsa Generating public/private rsa key pair. Enter file in which to save the key (/home/admin/.ssh/id_rsa): /home/admin/.ssh/id_rsa already exists. Overwrite (y/n)? y Enter passphrase (empty for no passphrase): Enter same passphrase again: Your identification has been saved in /home/admin/.ssh/id_rsa. Your public key has been saved in /home/admin/.ssh/id_rsa.pub.</pre> | | |
| 2 | Copy the public key <i>id_rsa.pub</i> to the Dell Force10 system. | | |
| 3 | Disable password authentication if enabled. | no ip ssh password-authentication enable | CONFIGURATION |
| 4 | Enable RSA authentication. | ip ssh rsa-authentication enable | EXEC Privilege |
| 5 | Bind the public keys to RSA authentication. | ip ssh rsa-authentication my-authorized-keys flash://public_key | EXEC Privilege |

Host-based SSH Authentication

Authenticate a particular host. This method uses SSH version 2.

To configure host-based authentication:

| Step | Task | Command Syntax | Command Mode |
|------|--|----------------|--------------|
| 1 | Configure RSA Authentication. See RSA Authentication of SSH , above. | | |

| Step | Task | Command Syntax | Command Mode |
|------|------|----------------|--------------|
|------|------|----------------|--------------|

- | | | | |
|---|---|--|--|
| 2 | Create shosts by copying the public RSA key to the to the file <i>shosts</i> in the directory <i>.ssh</i> , and write the IP address of the host to the file. | <code>cp /etc/ssh/ssh_host_rsa_key.pub /.ssh/shosts</code> | |
|---|---|--|--|

Figure 42-10. Creating shosts

```
admin@Unix_client# cd /etc/ssh
admin@Unix_client# ls
moduli      sshd_config      ssh_host_dsa_key.pub  ssh_host_key.pub
ssh_host_rsa_key.pub  ssh_config  ssh_host_dsa_key  ssh_host_key
ssh_host_rsa_key

admin@Unix_client# cat ssh_host_rsa_key.pub

ssh-rsa          AAAAB3NzaC1yc2EAAAABIwAAAIEA8K7jLZRVfjgHJzUOmXxuIbZx/
AyWhVgJDQh39k8v3e8eQvLnHBIsqIL8jVy1QHhUeb7GaDlJVEDAMz30myqQbJgXBBRTWgBpLWwL/
doyUXFufjjiL9YmoVTkbKcFmxJEMkE3JyHanEi7hg34LChjk9hL1by8cYZP2kYS2lnSyQWk=

admin@Unix_client# ls
id_rsa  id_rsa.pub  shosts

admin@Unix_client# cat shosts

10.16.127.201, ssh-rsa AAAAB3NzaC1yc2EAAAABIwAAAIEA8K7jLZRVfjgHJzUOmXxuIbZx/AyW
hVgJDQh39k8v3e8eQvLnHBIsqIL8jVy1QHhUeb7GaDlJVEDAMz30myqQbJgXBBRTWgBpLWwL/
doyUXFufjjiL9YmoVTkbKcFmxJEMkE3JyHanEi7hg34LChjk9hL1by8cYZP2kYS2lnSyQWk=
```

- | | | | |
|---|--|--|--|
| 3 | Create a list of IP addresses and usernames that are permitted to SSH in a file called <i>rhosts</i> , as shown in Figure 42-11. | | |
|---|--|--|--|

Figure 42-11. Creating rhosts

```
admin@Unix_client# ls
id_rsa  id_rsa.pub  rhosts  shosts
admin@Unix_client# cat rhosts
10.16.127.201  admin
```

- | | | | |
|---|---|---|---|
| 4 | Copy the file <i>shosts</i> and <i>rhosts</i> to the Dell Force10 system. | | |
| 5 | Disable password authentication and RSA authentication, if configured | <ul style="list-style-type: none"> no ip ssh password-authentication no ip ssh rsa-authentication | <ul style="list-style-type: none"> CONFIGURATION EXEC Privilege |
| 6 | Enable host-based authentication. | <code>ip ssh hostbased-authentication enable</code> | CONFIGURATION |
| 7 | Bind <i>shosts</i> and <i>rhosts</i> to host-based authentication. | <code>ip ssh pub-key-file flash://filename</code> <code>ip ssh rhostsfile flash://filename</code> | CONFIGURATION |

Client-based SSH Authentication

SSH from the chassis to the SSH client using using the command `ssh ip_address`. This method uses SSH version 1 or version 2. If the SSH port is a non-default value, use the command `ip ssh server port number`, to change the default port number. You may only change the port number when SSH is disabled. When must then still use the `-p` option with the command `ssh`.

Figure 42-12. Client-based SSH Authentication

```
FTOS#ssh 10.16.127.201 ?
-l           User name option
-p           SSH server port option (default 22)
-v           SSH protocol version
```

Troubleshooting SSH

- You may not bind *id_rsa.pub* to RSA authentication while logged in via the console. In this case, [Message 2](#) appears.

Message 2 RSA Authentication Error

```
%Error: No username set for this term.
```

- Host-based authentication must be enabled on the server (Dell Force10system) and the client (Unix machine). [Message 3](#) appears if you attempt to log in via SSH and host-based is disabled on the client. In this case, verify that host-based authentication is set to “Yes” in the file *ssh_config* (root permission is required to edit this file).

Message 3 Host-based Authentication Error

```
permission denied (host based)
```

- If the IP address in the RSA key does not match the IP address from which you attempt to log in, [Message 4](#) appears. In this case, verify that the name and IP address of the client is contained in the file */etc/hosts*.

Message 4 RSA Authentication Error

```
getname info 8 failed
```

Telnet

To use Telnet with SSH, you must first enable SSH, as described above.

By default, the Telnet daemon is enabled. If you want to disable the Telnet daemon, use the following command, or disable Telnet in the startup config.

Use the `[no] ip telnet server enable` command to enable or disable the Telnet daemon.

```
FTOS(conf)#ip telnet server enable
FTOS(conf)#no ip telnet server enable
```

Trace Lists

The [Trace Lists](#) feature is supported only on the E-Series: 

You can log packet activity on a port to confirm the source of traffic attacking a system. Once the Trace list is enabled on the system, you view its traffic log to confirm the source address of the attacking traffic. In FTOS, Trace lists are similar to extended IP ACLs, except that Trace lists are not applied to an interface. Instead, Trace lists are enabled for all switched traffic entering the system.

The number of entries allowed per trace list is 1K.

In the E-Series, you can create a trace filter based on any of the following criteria:

- Source IP address
- Destination IP address
- Source TCP port number
- Destination TCP port number
- Source UDP port number
- Destination UDP port number

For trace lists, you can match criteria on specific or ranges of TCP or UDP ports or established TCP sessions.



Note: If there are unresolved next-hops and a trace-list is enabled, there is a possibility that the traffic hitting the CPU will not be rate-limited.

When creating a trace list, the sequence of the filters is important. You have a choice of assigning sequence numbers to the filters as you enter them, or FTOS assigns numbers in the order the filters were created. For more information on sequence numbering, refer to [Chapter 21, IP Access Control Lists, Prefix Lists, and Route-maps](#).

Configuration Tasks for Trace Lists

The following configuration steps include mandatory and optional steps.

- [Creating a trace list](#) (mandatory)
- [Apply trace lists](#) (mandatory)

For a complete listing of all commands related to trace lists, refer to the Security chapter in the *FTOS Command Reference*.

Creating a trace list

Trace lists filter and log traffic based on source and destination IP addresses, IP host addresses, TCP addresses, TCP host addresses, UDP addresses, and UDP host addresses. When configuring the Trace list filters, include the count and bytes parameters so that any hits to that filter are logged.

Since traffic passes through the filter in the order of the filter's sequence, you can configure the trace list by first entering the TRACE LIST mode and then assigning a sequence number to the filter.

To create a filter for packets with a specified sequence number, use these commands in the following sequence, starting in the CONFIGURATION mode:

| Step | Command Syntax | Command Mode | Purpose |
|------|--|---------------|--|
| 1 | <code>ip trace-list <i>trace-list-name</i></code> | CONFIGURATION | Enter the TRACE LIST mode by creating an trace list. |
| 2 | <code>seq <i>sequence-number</i> {deny permit} {ip <i>ip-protocol-number</i>} {<i>source mask</i> any host <i>ip-address</i>} {<i>destination mask</i> any host <i>ip-address</i>} [count [byte] log]</code> | TRACE LIST | Configure a drop or forward filter. Configure the following required and optional parameters: <ul style="list-style-type: none">• <i>sequence-number</i> range: 0 to, 4294967290.• <i>ip</i>: to specify IP as the protocol to filter for.• <i>ip-protocol-number</i> range: 0 to 255.• <i>source</i>: An IP address as the source IP address for the filter to match.• <i>mask</i>: a network mask• <i>any</i>: to match any IP source address• host <i>ip-address</i>: to match IP addresses in a host.• <i>destination</i>: An IP address as the source IP address for the filter to match.• <i>count</i>: count packets processed by the filter.• <i>byte</i>: count bytes processed by the filter.• <i>log</i>: is supported. |

To create a filter for TCP packets with a specified sequence number, use these commands in the following sequence, starting in the CONFIGURATION mode:

| Step | Command Syntax | Command Mode | Purpose |
|------|---|---------------|--|
| 1 | <code>ip trace-list <i>trace-list-name</i></code> | CONFIGURATION | Create a trace list and assign it a unique name. |

| Step | Command Syntax | Command Mode | Purpose |
|------|--|--------------|---|
| 2 | seq <i>sequence-number</i> {deny permit} tcp { <i>source mask</i> any host <i>ip-address</i> } [<i>operator port</i> [<i>port</i>]] { <i>destination mask</i> any host <i>ip-address</i> } [<i>operator port</i> [<i>port</i>]] [established] [count [byte] log] | TRACE LIST | Configure a trace list filter for TCP packets. <ul style="list-style-type: none"> • <i>source</i>: An IP address as the source IP address for the filter to match. • <i>mask</i>: a network mask • <i>any</i>: to match any IP source address • <i>host ip-address</i>: to match IP addresses in a host. • <i>destination</i>: An IP address as the source IP address for the filter to match. • <i>count</i>: count packets processed by the filter. • <i>byte</i>: count bytes processed by the filter. • <i>log</i>: is supported. |

To create a filter for UDP packets with a specified sequence number, use these commands in the following sequence, starting in the CONFIGURATION mode:

| Step | Command Syntax | Command Mode | Purpose |
|------|--|---------------|---|
| 1 | ip trace-list <i>access-list-name</i> | CONFIGURATION | Create a trace list and assign it a unique name. |
| 2 | seq <i>sequence-number</i> {deny permit} udp { <i>source mask</i> any host <i>ip-address</i> } [<i>operator port</i> [<i>port</i>]] { <i>destination mask</i> any host <i>ip-address</i> } [<i>operator port</i> [<i>port</i>]] [count [byte] log] | TRACE LIST | Configure a trace list filter for UDP packets. <ul style="list-style-type: none"> • <i>source</i>: An IP address as the source IP address for the filter to match. • <i>mask</i>: a network mask • <i>any</i>: to match any IP source address • <i>host ip-address</i>: to match IP addresses in a host. • <i>destination</i>: An IP address as the source IP address for the filter to match. • <i>count</i>: count packets processed by the filter. • <i>byte</i>: count bytes processed by the filter. • <i>log</i>: is supported. |

When you create the filters with a specific sequence number, you can create the filters in any order and the filters are placed in the correct order.



Note: When assigning sequence numbers to filters, keep in mind that you might need to insert a new filter. To prevent reconfiguring multiple filters, assign sequence numbers in multiples of five or another number.

Figure 42-13 illustrates how the seq command orders the filters according to the sequence number assigned. In the example, filter 15 was configured before filter 5, but the show config command displays the filters in the correct order.

Figure 42-13. Trace list Using seq Command Example

```
FTOS(config-trace-acl)#seq 15 deny ip host 12.45.0.0 any log
FTOS(config-trace-acl)#seq 5 permit tcp 121.1.3.45 0.0.255.255 any
FTOS(config-trace-acl)#show conf
!
ip trace-list dilling
  seq 5 permit tcp 121.1.0.0 0.0.255.255 any
  seq 15 deny ip host 12.45.0.0 any log
FTOS(config-trace-acl)#
```

If you are creating a Trace list with only one or two filters, you can let FTOS assign a sequence number based on the order in which the filters are configured. FTOS assigns filters in multiples of 5.

To configure a filter for a Trace list without a specified sequence number, use any or all of the following commands in the TRACE LIST mode:

| Command Syntax | Command Mode | Purpose |
|--|--------------|---|
| <pre>{deny permit} {ip ip-protocol-number} {source mask any host ip-address} {destination mask any host ip-address} [count [byte] log]</pre> | TRACE LIST | <p>Configure a deny or permit filter to examine IP packets. Configure the following required and optional parameters:</p> <ul style="list-style-type: none"> • <i>ip</i>: to specify IP as the protocol to filter for. • <i>ip-protocol-number</i> range: 0 to 255. • <i>source</i>: An IP address as the source IP address for the filter to match. • <i>mask</i>: a network mask • <i>any</i>: to match any IP source address • <i>host ip-address</i>: to match IP addresses in a host. • <i>destination</i>: An IP address as the source IP address for the filter to match. • <i>count</i>: count packets processed by the filter. • <i>byte</i>: count bytes processed by the filter. • <i>log</i>: is supported. |

| Command Syntax | Command Mode | Purpose |
|---|--------------|---|
| {deny permit} tcp {source mask any host ip-address} [operator port [port]] {destination mask any host ip-address} [operator port [port]] [established] [count [byte] log] | TRACE LIST | <p>Configure a deny or permit filter to examine TCP packets. Configure the following required and optional parameters:</p> <ul style="list-style-type: none"> • <i>source</i>: An IP address as the source IP address for the filter to match. • <i>mask</i>: a network mask • <i>any</i>: to match any IP source address • <i>host ip-address</i>: to match IP addresses in a host. • <i>destination</i>: An IP address as the source IP address for the filter to match. • <i>precedence precedence</i> range: 0 to 7. • <i>tos tos-value</i> range: 0 to 15 • <i>count</i>: count packets processed by the filter. • <i>byte</i>: count bytes processed by the filter. • <i>log</i>: is supported. |
| {deny permit} udp {source mask any host ip-address} [operator port [port]] {destination mask any host ip-address} [operator port [port]] log] | TRACE LIST | <p>Configure a deny or permit filter to examine UDP packets. Configure the following required and optional parameters:</p> <ul style="list-style-type: none"> • <i>source</i>: An IP address as the source IP address for the filter to match. • <i>mask</i>: a network mask • <i>any</i>: to match any IP source address • <i>host ip-address</i>: to match IP addresses in a host. • <i>destination</i>: An IP address as the source IP address for the filter to match. • <i>precedence precedence</i> range: 0 to 7. • <i>tos tos-value</i> range: 0 to 15 • <i>count</i>: count packets processed by the filter. • <i>byte</i>: count bytes processed by the filter. • <i>log</i>: is supported. |

Figure 42-14 illustrates a Trace list in which the sequence numbers were assigned by the software. The filters were assigned sequence numbers based on the order in which they were configured (for example, the first filter was given the lowest sequence number). The show config command in the TRACE LIST mode displays the two filters with the sequence numbers 5 and 10.

Figure 42-14. Trace List Example

```
FTOS(config-trace-acl)#deny tcp host 123.55.34.0 any
FTOS(config-trace-acl)#permit udp 154.44.123.34 0.0.255.255 host 34.6.0.0
FTOS(config-trace-acl)#show config
!
ip trace-list nimule
seq 5 deny tcp host 123.55.34.0 any
seq 10 permit udp 154.44.0.0 0.0.255.255 host 34.6.0.0
```

To view all configured Trace lists and the number of packets processed through the Trace list, use the `show ip accounting trace-list` command (Figure 110) in the EXEC Privilege mode.

Apply trace lists

After you create a Trace list, you must enable it. Without enabling the Trace list, no traffic is filtered.

You can enable one Trace list.

To enable a Trace list, use the following command in the CONFIGURATION mode:

| Command Syntax | Command Mode | Purpose |
|--|---------------|---|
| <code>ip trace-group <i>trace-list-name</i></code> | CONFIGURATION | Enable a configured Trace list to filter traffic. |

To remove a Trace list, use the `no ip trace-group trace-list-name` command syntax.

Once the Trace list is enabled, you can view its log with the `show ip accounting trace-list trace-list-name [linecard number]` command.

Figure 42-15. show ip accounting trace-list Command Example

```
FTOS#show ip accounting trace-list dilling
Trace List dilling on linecard 0
seq 2 permit ip host 10.1.0.0 any count (0 packets)
seq 5 deny ip any any
FTOS#
```

VTY Line and Access-Class Configuration

Various methods are available to restrict VTY access in FTOS. These depend on which authentication scheme you use — line, local, or remote:

Table 42-1. VTY Access

| Authentication Method | VTY access-class support? | Username access-class support? | Remote authorization support? |
|-----------------------|---------------------------|--------------------------------|-----------------------------------|
| Line | YES | NO | NO |
| Local | NO | YES | NO |
| TACACS+ | YES | NO | YES (with FTOS 5.2.1.0 and later) |
| RADIUS | YES | NO | YES (with FTOS 6.1.1.0 and later) |

FTOS provides several ways to configure access classes for VTY lines, including:

- [VTY Line Local Authentication and Authorization on page 850](#)
- [VTY Line Remote Authentication and Authorization on page 851](#)

VTY Line Local Authentication and Authorization

FTOS retrieves the access class from the local database. To use this feature:

1. Create a username
2. Enter a password
3. Assign an access class
4. Enter a privilege level

Line authentication can be assigned on a per-VTY basis; it is a simple password authentication, using an access-class as authorization.

Local authentication is configured globally. You configure access classes on a per-user basis.

FTOS can assign different access classes to different users by username. Until users attempt to log in, FTOS does not know if they will be assigned a VTY line. This means that incoming users always see a login prompt even if you have excluded them from the VTY line with a deny-all access class. Once users identify themselves, FTOS retrieves the access class from the local database and applies it. (FTOS also subsequently can close the connection if a user is denied access).



Note: If a VTY user logs in with RADIUS authentication, the privilege level will be applied from the RADIUS server only if RADIUS authentication is configured.

Figure 42-16 shows how to allow or deny a Telnet connection to a user. Users will see a login prompt, even if they cannot login. No access class is configured for the VTY line. It defaults from the local database.

Figure 42-16. Example Access-Class Configuration Using Local Database

```
FTOS(conf)#user gooduser password abc privilege 10 access-class permitall
FTOS(conf)#user baduser password abc privilege 10 access-class denyall
FTOS(conf)#
FTOS(conf)#aaa authentication login localmethod local
FTOS(conf)#
FTOS(conf)#line vty 0 9
FTOS(config-line-vty)#login authentication localmethod
FTOS(config-line-vty)#end
```



Note: See also the section [Chapter 7, Access Control Lists \(ACLs\)](#).

VTY Line Remote Authentication and Authorization

FTOS retrieves the access class from the VTY line.

The Dell Force10 OS takes the access class from the VTY line and applies it to ALL users. FTOS does not need to know the identity of the incoming user and can immediately apply the access class. If the authentication method is radius, TACACS+, or line, and you have configured an access class for the VTY line, FTOS immediately applies it. If the access-class is deny all or deny for the incoming subnet, FTOS closes the connection without displaying the login prompt. The following example shows how to deny incoming connections from subnet 10.0.0.0 without displaying a login prompt. The example uses TACACS+ as the authentication mechanism.

Figure 42-17. Example Access Class Configuration Using TACACS+ Without Prompt

```
FTOS(conf)#ip access-list standard deny10
FTOS(conf-ext-nacl)#permit 10.0.0.0/8
FTOS(conf-ext-nacl)#deny any
FTOS(conf)#
FTOS(conf)#aaa authentication login tacacsmethod tacacs+
FTOS(conf)#tacacs-server host 256.1.1.2 key Force10
FTOS(conf)#
FTOS(conf)#line vty 0 9
FTOS(config-line-vty)#login authentication tacacsmethod
FTOS(config-line-vty)#
FTOS(config-line-vty)#access-class deny10
FTOS(config-line-vty)#end
(same applies for radius and line authentication)
```

VTY MAC-SA Filter Support

FTOS supports MAC access lists which permit or deny users based on their source MAC address. With this approach, you can implement a security policy based on the source MAC address.

To apply a MAC ACL on a VTY line, use the same access-class command as IP ACLs (Figure 42-18). Figure 42-18 shows how to deny incoming connections from subnet 10.0.0.0 without displaying a login prompt.

Figure 42-18. Example Access Class Configuration Using TACACS+ Without Prompt

```
FTOS(conf)#mac access-list standard sourcemac
FTOS(config-std-mac)#permit 00:00:5e:00:01:01
FTOS(config-std-mac)#deny any
FTOS(conf)#
FTOS(conf)#line vty 0 9
FTOS(config-line-vty)#access-class sourcemac
FTOS(config-line-vty)#end
```

Service Provider Bridging

Service Provider Bridging is supported on platforms: e C S **S4810** **S4820T**

This chapter contains the following major sections:

- VLAN Stacking
- VLAN Stacking Packet Drop Precedence
- Dynamic Mode CoS for VLAN Stacking
- Layer 2 Protocol Tunneling
- Provider Backbone Bridging

VLAN Stacking

VLAN Stacking is supported on platforms: C e S

VLAN Stacking, also called Q-in-Q, is defined in IEEE 802.1ad—Provider Bridges, which is an amendment to IEEE 802.1Q—Virtual Bridged Local Area Networks. It enables service providers to use 802.1Q architecture to offer separate VLANs to customers with no coordination between customers, and minimal coordination between customers and the provider.

Using only 802.1Q VLAN tagging all customers would have to use unique VLAN IDs to ensure that traffic is segregated, and customers and the service provider would have to coordinate to ensure that traffic mapped correctly across the provider network. Even under ideal conditions, customers and the provider would still share the 4094 available VLANs.

Instead, 802.1ad allows service providers to add their own VLAN tag to frames traversing the provider network. The provider can then differentiate customers even if they use the same VLAN ID, and providers can map multiple customers to a single VLAN to overcome the 4094 VLAN limitation. Forwarding decisions in the provider network are based on the provider VLAN tag only, so the provider can map traffic through the core independently; the customer and provider need only coordinate at the provider edge.

In at the access point of a VLAN-stacking network, service providers add a VLAN tag, the S-Tag, to each frame before the 802.1Q tag. From this point, the frame is double-tagged. The service provider uses the S-Tag, to forward the frame traffic across its network. At the egress edge, the provider removes the S-Tag, so that the customer receives the frame in its original condition (Figure 43-1).

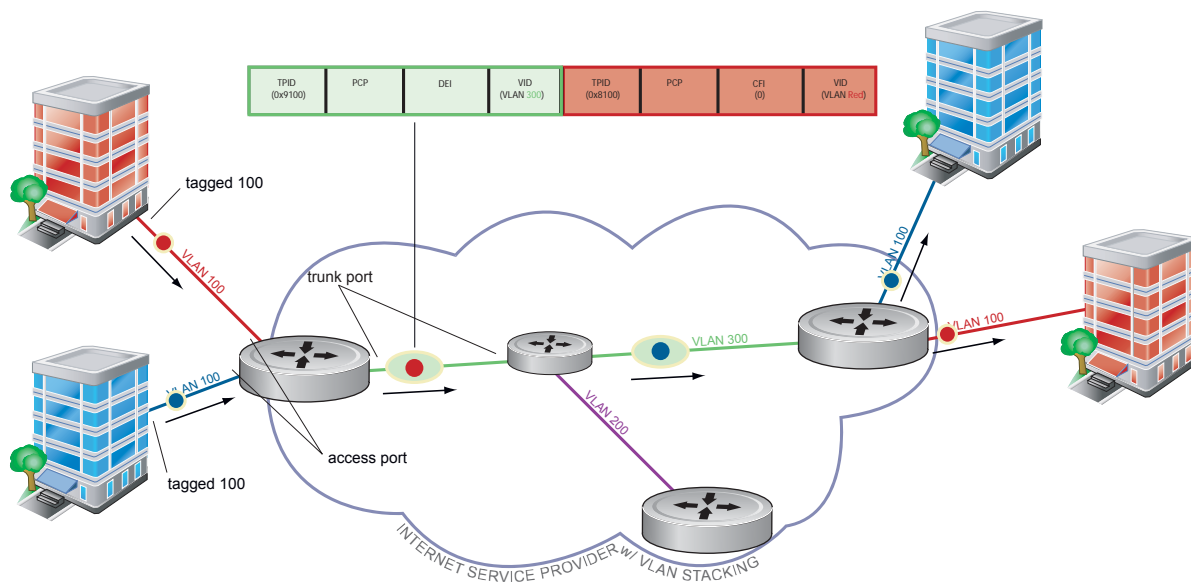
Figure 43-1. VLAN Stacking in a Service Provider Network

Important Points to Remember

- Interfaces that are members of the Default VLAN and are configured as VLAN-Stack access or trunk ports do not switch untagged traffic. To switch traffic, these interfaces must be added to a non-default VLAN-Stack-enabled VLAN.
- Dell Force10 cautions against using the same MAC address on different customer VLANs, on the same VLAN-Stack VLAN.
- You can ping across a trunk port only if both systems on the link are an E-Series. You cannot ping across the link if one or both of the systems is a C-Series or S-Series.
- This limitation becomes relevant if you enable the port as a multi-purpose port (carrying single-tagged and double-tagged traffic).

Configure VLAN Stacking

Configuring VLAN-Stacking is a three-step process:

1. Create access and trunk ports. See page 855.
2. Assign access and trunk ports to a VLAN. See page 855.
3. Make the VLAN VLAN-stacking capable.

Related Configuration Tasks

- [Configure the Protocol Type Value for the Outer VLAN Tag on page 856](#)
- [FTOS Options for Trunk Ports on page 856](#)
- [Debug VLAN Stacking on page 857](#)
- [VLAN Stacking in Multi-vendor Networks on page 858](#)

Create Access and Trunk Ports

An **access port** is a port on the service provider edge that directly connects to the customer. An access port may belong to only one service provider VLAN.

A **trunk port** is a port on a service provider bridge that connects to another service provider bridge and is a member of multiple service provider VLANs.

Physical ports and port-channels can be access or trunk ports.

To create access and trunk ports:

| Step | Task | Command Syntax | Command Mode |
|------|--|-------------------|----------------|
| 1 | Assign the role of access port to a Layer 2 port on a provider bridge that is connected to a customer. | vlan-stack access | INTERFACE |
| 2 | Assign the role of trunk port to a Layer 2 port on a provider bridge that is connected to another provider bridge. | vlan-stack trunk | INTERFACE |
| 3 | Assign all access ports and trunk ports to service provider VLANs. | member | INTERFACE VLAN |

Display the VLAN-Stacking configuration for a switchport using the command `show config` from INTERFACE mode, as shown in [Figure 43-2](#).

Figure 43-2. Displaying the VLAN-Stack Configuration on a Layer 2 Port

```
FTOS#show run interface gi 7/0
!
interface GigabitEthernet 7/0
 no ip address
 switchport
 vlan-stack access
 no shutdown
FTOS#show run interface gi 7/12
!
interface GigabitEthernet 7/12
 no ip address
 switchport
 vlan-stack trunk
 no shutdown
```

Enable VLAN-Stacking for a VLAN

To enable VLAN-Stacking for a VLAN:

| Task | Command Syntax | Command Mode |
|------------------------------------|----------------|-----------------------|
| Enable VLAN-Stacking for the VLAN. | INTERFACE VLAN | vlan-stack compatible |

Display the status and members of a VLAN using the `show vlan` command from EXEC Privilege mode. Members of a VLAN-Stacking-enabled VLAN are marked with an *M* in column *Q*.

Figure 43-3. Display the Members of a VLAN-Stacking-enabled VLAN

```
FTOS#show vlan

Codes: * - Default VLAN, G - GVRP VLANs

  NUM   Status   Q Ports
*  1     Active   U Gi 13/0-5,18
  2     Inactive
  3     Inactive
  4     Inactive
  5     Inactive
  6     Active   M Po1(Gi 13/14-15)
                               M Gi 13/13

FTOS#
```

Configure the Protocol Type Value for the Outer VLAN Tag

The Tag Protocol Identifier (TPID) field of the S-Tag is user-configurable:

| Task | Command Syntax | Command Mode |
|---|----------------|--------------------------|
| Select a value for the S-Tag TPID. Default: 9100 | CONFIGURATION | vlan-stack protocol-type |

Display the S-Tag TPID for a VLAN using the command `show running-config` from EXEC privilege mode. FTOS displays the S-Tag TPID only if it is a non-default value.

FTOS Options for Trunk Ports

802.1ad trunk ports may also be tagged members of a VLAN so that it can carry single and double-tagged traffic.

You can enable trunk ports to carry untagged, single-tagged, and double-tagged VLAN traffic by making the trunk port a hybrid port.

| Step | Task | Command Syntax | Command Mode |
|------|--|-----------------|--------------|
| 1 | Configure a trunk port to carry untagged, single-tagged, and double-tagged traffic by making it a hybrid port. Note: Note: On the C-Series and S-Series, a trunk port can be added to an 802.1Q VLAN as well as a Stacking VLAN only when the TPID 0x8100. | portmode hybrid | INTERFACE |

| Step | Task | Command Syntax | Command Mode |
|------|--|---------------------|----------------|
| 2 | Add the port to a 802.1Q VLAN as tagged or untagged. | [tagged untagged] | INTERFACE VLAN |

In [Figure 43-4](#) GigabitEthernet 0/1 a trunk port that is configured as a hybrid port and then added to VLAN 100 as untagged VLAN 101 as tagged, and VLAN 103, which is a stacking VLAN.

Figure 43-4. Hybrid Port as VLAN-Stack Trunk Port and as Member of other VLANs

```

FTOS(conf)#int gi 0/1
FTOS(conf-if-gi-0/1)#portmode hybrid
FTOS(conf-if-gi-0/1)#switchport
FTOS(conf-if-gi-0/1)#vlan-stack trunk
FTOS(conf-if-gi-0/1)#show config
!
interface GigabitEthernet 0/1
  no ip address
  portmode hybrid
  switchport
  vlan-stack trunk
  shutdown
FTOS(conf-if-gi-0/1)#interface vlan 100
FTOS(conf-if-vl-100)#untagged gigabitethernet 0/1
FTOS(conf-if-vl-100)#interface vlan 101
FTOS(conf-if-vl-101)#tagged gigabitethernet 0/1
FTOS(conf-if-vl-101)#interface vlan 103
FTOS(conf-if-vl-103)#vlan-stack compatible
FTOS(conf-if-vl-103-stack)#member gigabitethernet 0/1
FTOS(conf-if-vl-103-stack)#do show vlan

Codes: * - Default VLAN, G - GVRP VLANs
Q: U - Untagged, T - Tagged
  x - Dot1x untagged, X - Dot1x tagged
  G - GVRP tagged, M - Vlan-stack

  NUM      Status      Description                               Q Ports
*   1       Inactive
    100     Inactive                               U Gi 0/1
    101     Inactive                               T Gi 0/1
    103     Inactive                               M Gi 0/1

```

Debug VLAN Stacking

To debug the internal state and membership of a VLAN and its ports, use the debug member command, as shown in [Figure 43-5](#). The port notations in [Figure 43-5](#) are as follows:

- **MT** — stacked trunk
- **MU** — stacked access port
- **T** — 802.1Q trunk port
- **U** — 802.1Q access port
- **NU** — Native VLAN (untagged)

Figure 43-5. Example of Output of debug member vlan and debug member port

```

FTOS# debug member vlan 603
vlan id   : 603
ports    : Gi 2/47 (MT), Gi 3/1(MU), Gi 3/25(MT), Gi 3/26(MT), Gi 3/27(MU)

FTOS#debug member port gigabitethernet 2/47
vlan id   : 603 (MT), 100(T), 101(NU)
FTOS#

```

VLAN Stacking in Multi-vendor Networks

The first field in the VLAN tag is the Tag Protocol Identifier (TPID), which is two bytes. In a VLAN-stacking network, once the frame is double tagged, the outer tag TPID must match the TPID of the next-hop system.

While 802.1Q requires that the inner tag TPID is 0x8100, it does not require a specific value for the outer tag TPID. Systems may use any two-byte value; FTOS uses 0x9100 (Figure 43-6) while non-Dell Force10 systems might use a different value.

If the next-hop system's TPID does not match the outer-tag TPID of the incoming frame, the system drops the frame. For example, in Figure 43-6, the frame originating from Building A is tagged VLAN RED, and then double-tagged VLAN PURPLE on egress at R4. The TPID on the outer tag is 0x9100. R2's TPID must also be 0x9100, and it is, so R2 forwards the frame.

Given the matching-TPID requirement, there are limitations when you employ Dell Force10 systems at network edges, at which, frames are either double tagged on ingress (R4) or the outer tag is removed on egress (R3).

VLAN Stacking with E-Series TeraScale Systems

The default TPID for the outer VLAN tag is 0x9100. Although the TPID field is 16 bits, E-Series TeraScale only uses the first eight to make forwarding decisions, and as such makes no distinction between 0x8100 and any other TPID beginning with 0x81, for example, 0x8181. You can configure the first eight bits of the TPID using the command `vlan-stack protocol-type` command. In Figure 43-6, the frame originating from Building C is tagged 0x9191 on egress of R1. R2's TPID is 0x9100, but it is an E-Series TeraScale system and makes no distinction between 0x9191 and 0x9100, so it forwards the frame.

Figure 43-6. TPID Match and First-byte Match on the E-Series TeraScale

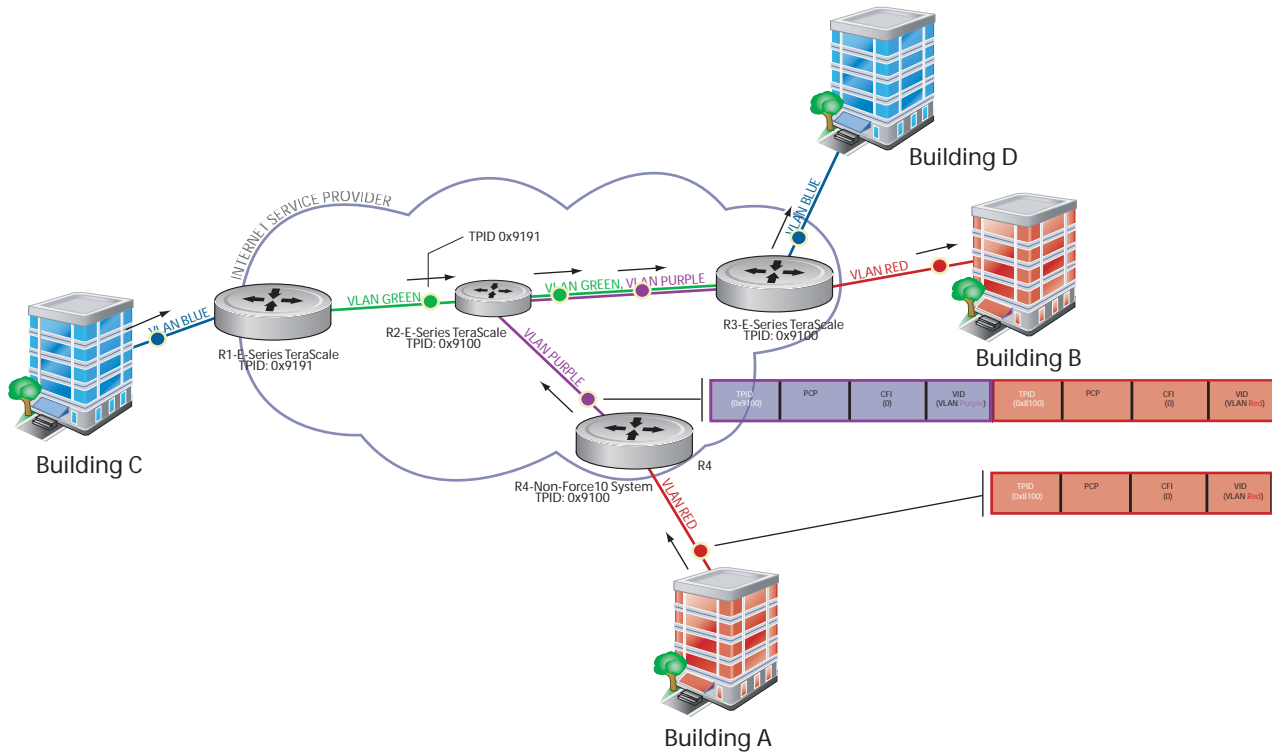

TPID 0x8100 on E-Series TeraScale Systems

E-Series TeraScale treats TPID 0x8100 as a normal VLAN even when on the outer tag. E-Series TeraScale makes forwarding decisions based strictly on the protocol type, without regard for whether the port is an access port. Therefore, when the outer tag has TPID 0x8100, the system does not remove it from frames egressing an access port. Still, although the frames cannot be decapsulated, the system is able to switch them. In Figure 43-7, the frame originating from Building A is double tagged on egress at R4 and is switched towards Building B, but is not decapsulated on egress at R2 because its TPID is 0x8181.

FTOS Behavior: The E-Series ExaScale and TeraScale forward frames with TPID 0x8100 even when its own TPID is not 0x8100. This behavior is required to service ARP and PVST packets, which use TPID 0x8100.

Figure 43-7. TPID Mismatch and 0x8100 Match on the E-Series TeraScale

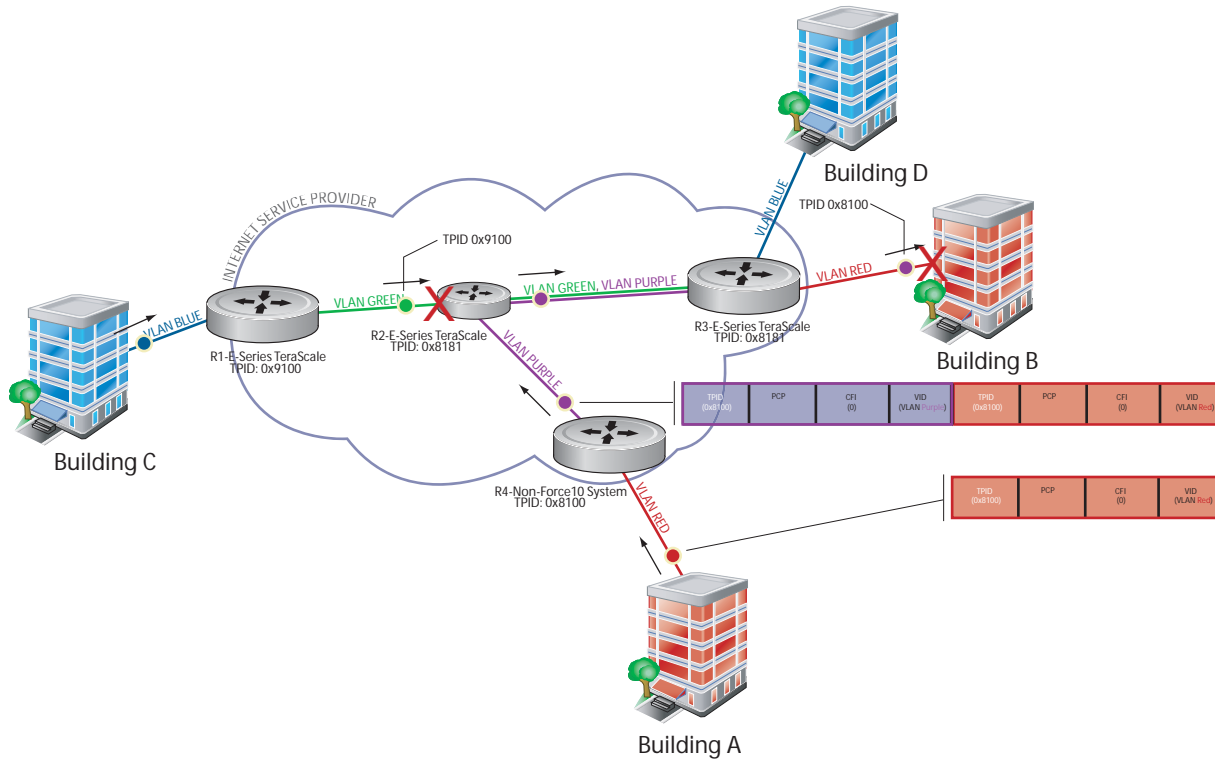

VLAN Stacking with E-Series ExaScale Systems

E-Series ExaScale, beginning with FTOS version 8.2.1.0, allows you to configure both bytes of the 2-byte TPID. TeraScale systems allow you to configure the first byte only and thus, the system did not differentiate between TPIDs with a common first byte. For example 0x9100 and 0x91A8 were treated as the same TPID. In Figure 43-6, R2 forwards the frame with TPID 0x9191 which originated from Building C. In contrast, R2 drops the frame with TPID 0x9191 originating from Building C in Figure 43-8 because the frames TPID does not match both bytes of its own TPID.

FTOS Behavior: The E-Series ExaScale and TeraScale forwards frames with TPID 0x8100 even when its own TPID is not 0x8100. This behavior is required to service ARP and PVST packets, which use TPID 0x8100.

Figure 43-8. First-byte TPID Match on the E-Series ExaScale

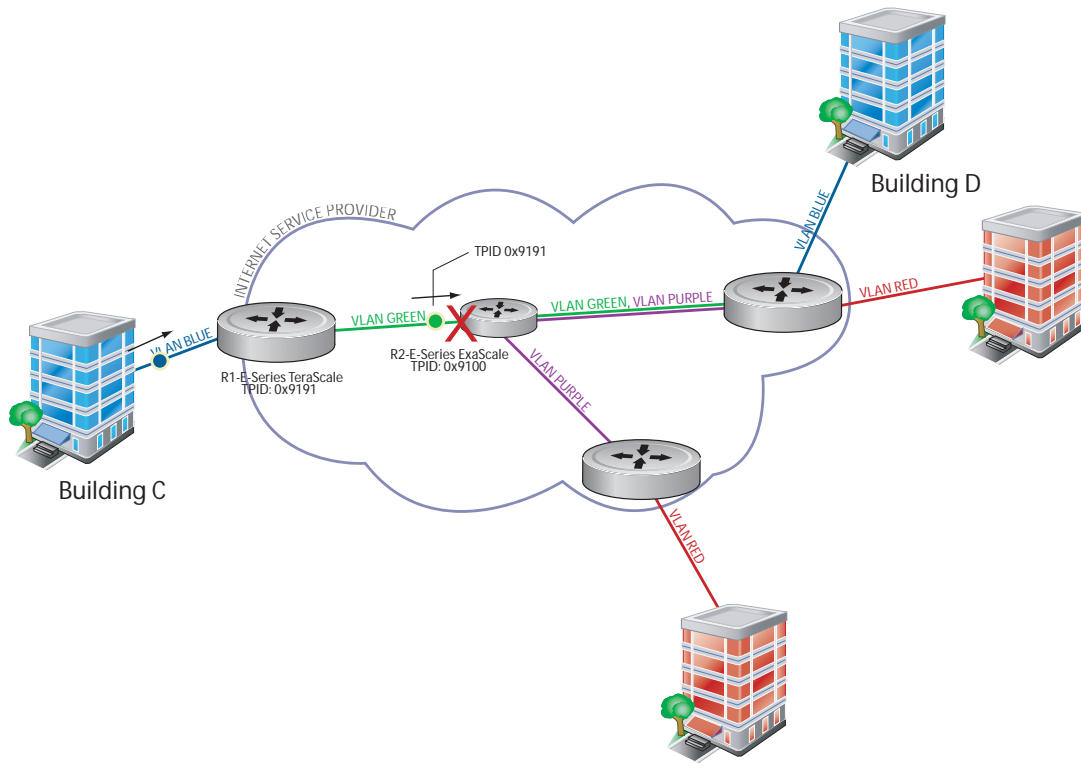

Table 43-1 details the outcome of matched and mis-matched TPIDs in a VLAN-stacking network with the E-Series.

Table 43-1. E-Series Behaviors for Mis-matched TPID

| Network Position | Incoming Packet TPID | System TPID | Match Type | TeraScale Behavior | ExaScale Behavior |
|---------------------|----------------------|-------------|----------------|---------------------------------|-------------------|
| Core | 0xUVWX | 0xUVYZ | 1st-byte match | switch as 0xUVYZ | drop |
| | 0xUVWZ | 0xQRST | mismatch | drop | drop |
| Egress Access Point | 0xUVWX | 0xUVYZ | 1st-byte match | switch as 0xUVYZ | drop |
| | 0x81WX | 0x81YZ | 1st-byte match | switch as is (no decapsulation) | drop |
| | 0xUVWZ | 0xQRST | mismatch | drop | drop |

VLAN Stacking with C-Series and S-Series

The default TPID for the outer VLAN tag is 0x9100. Beginning with FTOS version 8.2.1.0, both the C-Series and S-Series allow you to configure both bytes of the 2-byte TPID. Previous versions allowed you to configure the first byte only, and thus, the systems did not differentiate between TPIDs with a common first byte. For example 0x8100 and any other TPID beginning with 0x81 were treated as the same TPID, as shown in Figure 43-9. Versions 8.2.1.0 and later differentiate between 0x9100 and 0x91XY, as shown in Figure 43-11.

You can configure the first eight bits of the TPID using the command `vlan-stack protocol-type`.

The TPID on the C-Series and S-Series systems is global. Ingress frames that do not match the system TPID are treated as untagged. This rule applies for both the outer tag TPID of a double-tagged frame and the TPID of a single-tagged frame.

For example, if you configure TPID 0x9100, then the system treats 0x8100 and untagged traffic the same and maps both types to the default VLAN, as shown by the frame originating from Building C in Figure 43-11. For the same traffic types, if you configure TPID 0x8100, then the system is able to differentiate between 0x8100 and untagged traffic and maps each to the appropriate VLAN, as shown by the packet originating from Building A in Figure 43-11.

Therefore, a mismatched TPID results in the port not differentiating between tagged and untagged traffic.

Figure 43-9. Single and Double-tag TPID Match on the C-Series and S-Series

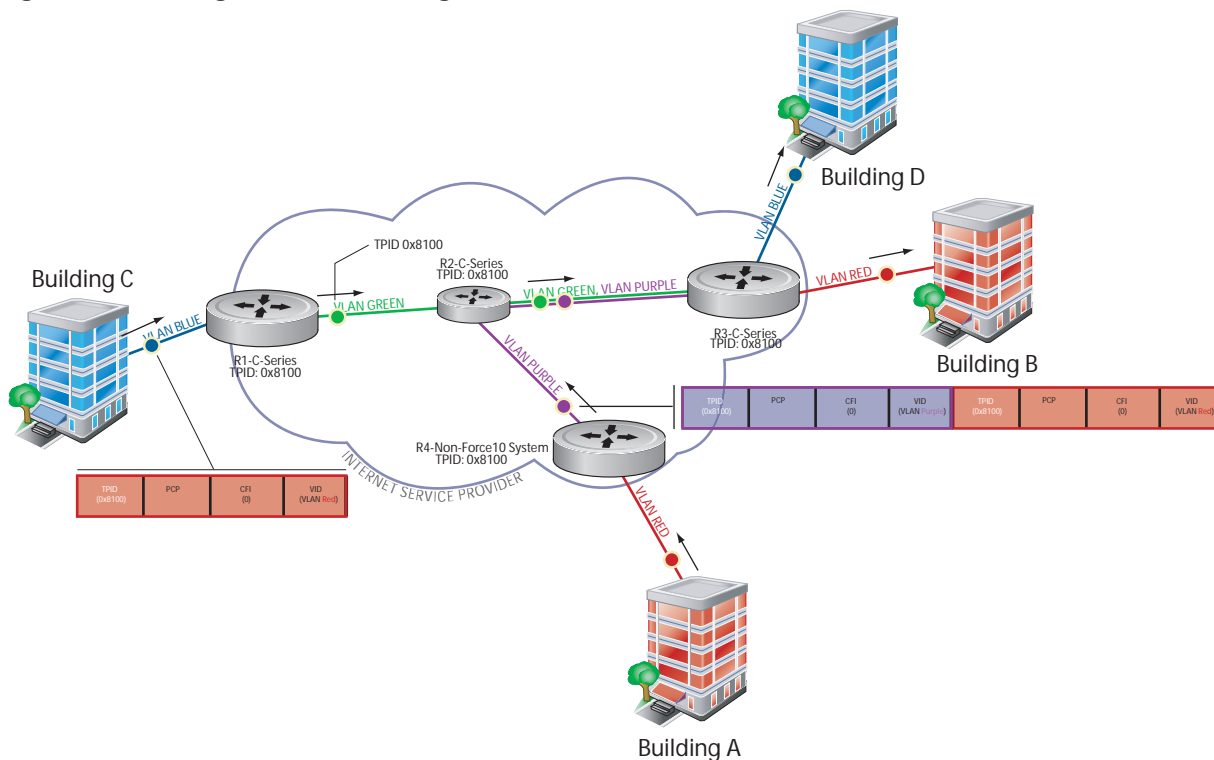

Figure 43-10. Single and Double-tag First-byte TPID Match on C-Series and S-Series

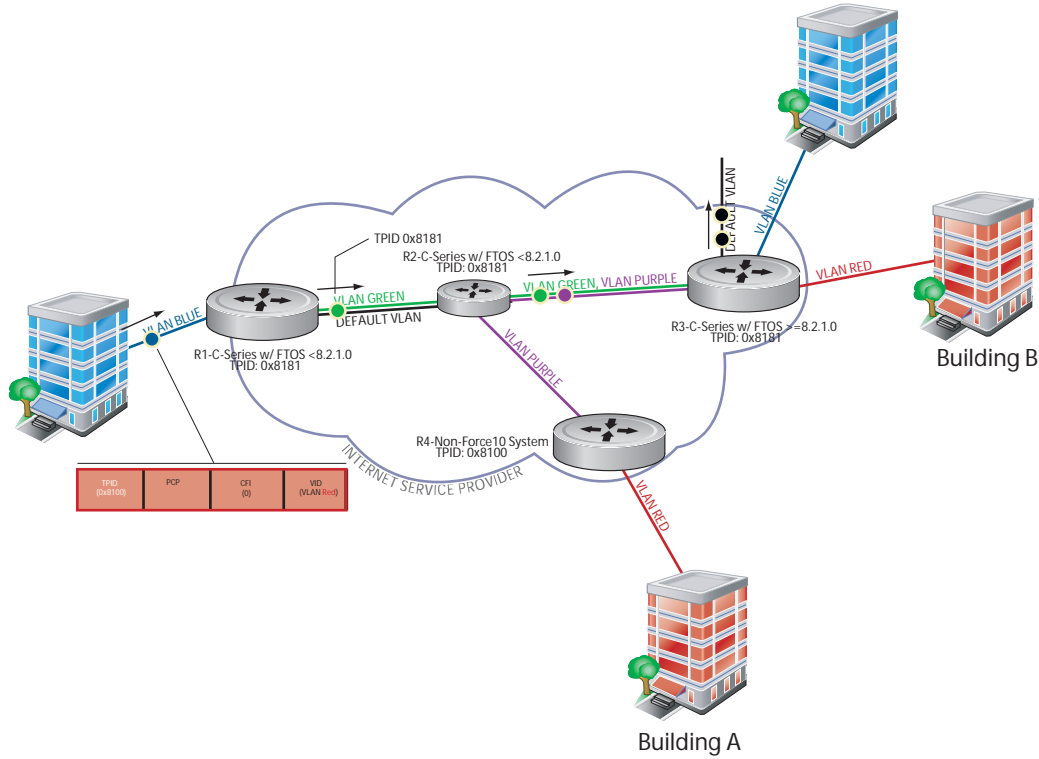

Figure 43-11. Single and Double-tag TPID Mismatch on the C-Series and S-Series

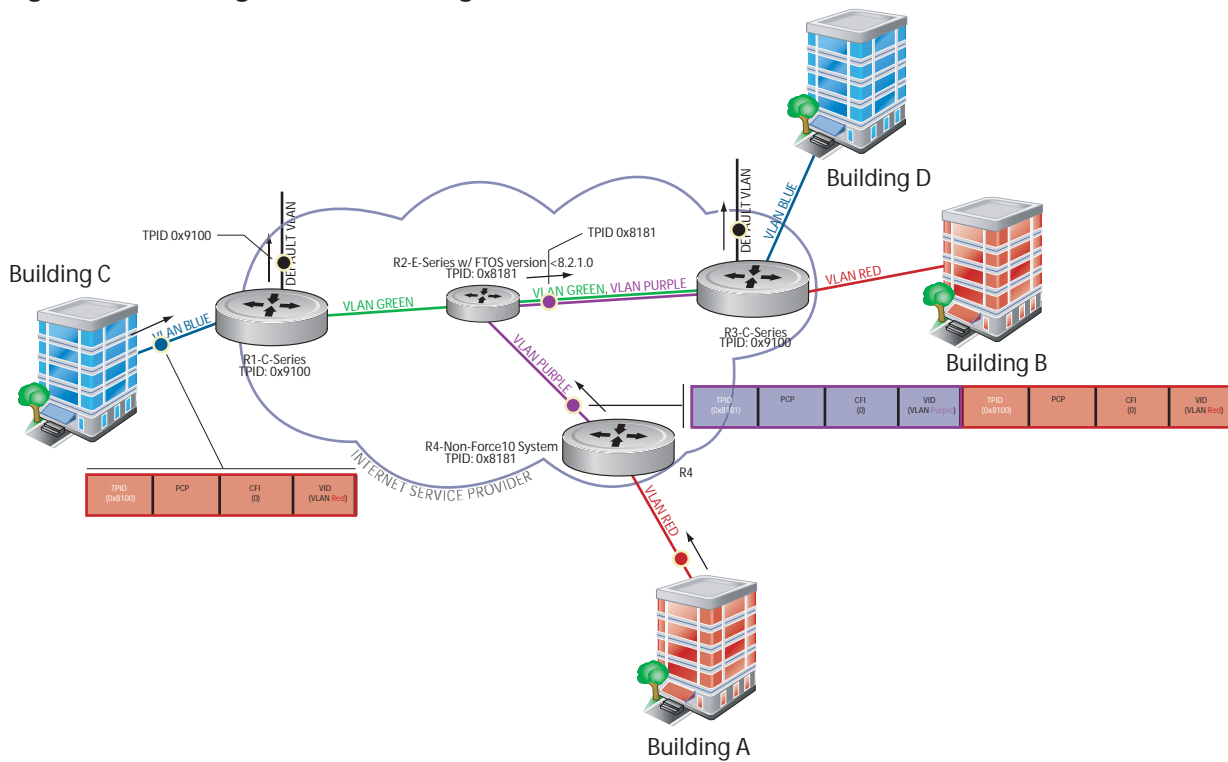

Table 43-2 details the outcome of matched and mismatched TPIDs in a VLAN-stacking network with the C-Series and S-Series.

Table 43-2. C-Series and S-Series Behaviors for Mis-matched TPID

| Network Position | Incoming Packet TPID | System TPID | Match Type | Pre-8.2.1.0 | 8.2.1.0+ |
|----------------------|----------------------|-------------|-----------------------------|------------------------|------------------------|
| Ingress Access Point | untagged | 0xUVWX | — | switch to default VLAN | switch to default VLAN |
| | single-tag (0x8100) | 0xUVWX | single-tag mismatch | switch to default VLAN | switch to default VLAN |
| | | 0x8100 | single-tag match | switch to VLAN | switch to VLAN |
| | | 0x81XY | single-tag first-byte match | switch to VLAN | switch to default VLAN |
| Core | untagged | 0xUVWX | — | switch to default VLAN | switch to default VLAN |
| | double-tag 0xUVWX | 0xUVWX | double-tag match | switch to VLAN | switch to VLAN |
| | | 0xUVYZ | double-tag first-byte match | switch to VLAN | switch to default VLAN |
| | | 0xQRST | double-tag mismatch | switch to default VLAN | switch to default VLAN |
| Egress Access Point | untagged | 0xUVWX | — | switch to default VLAN | switch to default VLAN |
| | double-tag 0xUVWX | 0xUVWX | double-tag match | switch to VLAN | switch to VLAN |
| | | 0xUVYZ | double-tag first-byte match | switch to VLAN | switch to default VLAN |
| | | 0xQRST | double-tag mismatch | switch to default VLAN | switch to default VLAN |

VLAN Stacking Packet Drop Precedence

VLAN Stacking Packet Drop Precedence is available only on platform: **C S**

The Drop Eligible Indicator (DEI) bit in the S-Tag indicates to a service provider bridge which packets it should prefer to drop when congested.

Enable Drop Eligibility

You must enable Drop Eligibility globally before you can honor or mark the DEI value.

| Task | Command Syntax | Command Mode |
|--|-------------------------|---------------|
| Make packets eligible for dropping based on their DEI value. By default, packets are colored green, and DEI is marked 0 on egress. | <code>dei enable</code> | CONFIGURATION |

When Drop Eligibility is enabled, DEI mapping or marking takes place according to the defaults. In this case, the CFI is affected according to [Table 43-3](#).

Table 43-3. Drop Eligibility Behavior

| Ingress | Egress | DEI Disabled | DEI Enabled |
|-------------|-------------|------------------------|------------------------|
| Normal Port | Normal Port | Retain CFI | Set CFI to 0 |
| Trunk Port | Trunk Port | Retain inner tag CFI | Retain inner tag CFI |
| | | Retain outer tag CFI | Set outer tag CFI to 0 |
| Access Port | Trunk Port | Retain inner tag CFI | Retain inner tag CFI |
| | | Set outer tag CFI to 0 | Set outer tag CFI to 0 |

Honor the Incoming DEI Value

To honor the incoming DEI value, you must explicitly map the DEI bit to an FTOS drop precedence; precedence can have one of three colors:

| Precedence | Description |
|------------|---|
| Green | High priority packets that are the least preferred to be dropped. |
| Yellow | Lower priority packets that are treated as best-effort. |
| Red | Lowest priority packets that are <i>always</i> dropped (regardless of congestion status). |

| Task | Command Syntax | Command Mode |
|---|---|----------------|
| Honor the incoming DEI value by mapping it to an FTOS drop precedence. You may enter the command once for 0 and once for 1. Packets with an unmapped DEI value are colored green. | <code>dei honor {0 1} {green red yellow}</code> | INTERFACE |
| Display the DEI-honoring configuration. | <code>show interface dei-honor [interface slot/port linecard number port-set number]</code> | EXEC Privilege |

| Task | Command Syntax | Command Mode |
|--------------------------------|----------------|-----------------|
| FTOS#show interface dei-honor | | |
| Default Drop precedence: Green | | |
| Interface | CFI/DEI | Drop precedence |
| ----- | | ----- |
| Gi 0/1 | 0 | Green |
| Gi 0/1 | 1 | Yellow |
| Gi 8/9 | 1 | Red |
| Gi 8/40 | 0 | Yellow |

Mark Egress Packets with a DEI Value

On egress, you can set the DEI value according to a different mapping than ingress (see [Honor the Incoming DEI Value](#)).

| Task | Command Syntax | Command Mode |
|--|---|----------------|
| Set the DEI value on egress according to the color currently assigned to the packet. | dei mark {green yellow} {0 1} | INTERFACE |
| Display the DEI-marking configuration. | show interface dei-mark [<i>interface slot/port</i> linecard <i>number</i> port-set <i>number</i>] | EXEC Privilege |
| FTOS#show interface dei-mark | | |
| Default CFI/DEI Marking: 0 | | |
| Interface | Drop precedence | CFI/DEI |
| ----- | | ----- |
| Gi 0/1 | Green | 0 |
| Gi 0/1 | Yellow | 1 |
| Gi 8/9 | Yellow | 0 |
| Gi 8/40 | Yellow | 0 |

Dynamic Mode CoS for VLAN Stacking

[Dynamic Mode CoS for VLAN Stacking](#) is available only on platforms: **C S**

One of the ways to ensure quality of service for customer VLAN-tagged frames is to use the 802.1p priority bits in the tag to indicate the level of QoS desired. When an S-Tag is added to incoming customer frames, the 802.1p bits on the S-Tag may be configured statically for each customer or derived from the C-Tag using *Dynamic Mode CoS*. Dynamic Mode CoS maps the C-Tag 802.1p value to a S-Tag 802.1p value.

Figure 43-12. Statically and Dynamically Assigned dot1p for VLAN Stacking

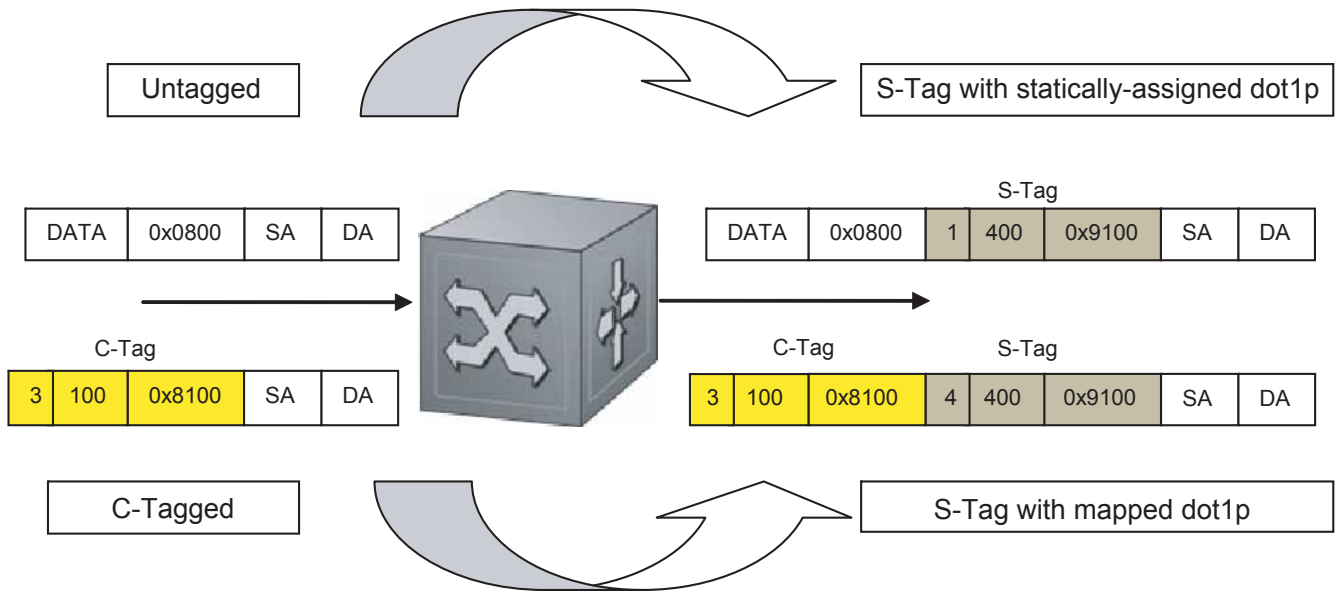

When configuring Dynamic Mode CoS, you have two options:

- a mark the S-Tag dot1p and queue the frame according to the original C-Tag dot1p. In this case, you must have other dot1p QoS configurations; this option is classic dot1p marking.
- b mark the S-Tag dot1p and queue the frame according to the S-Tag dot1p. For example, if frames with C-Tag dot1p values 0, 6 and 7 are mapped to an S-Tag dot1p value 0, then all such frames are sent to the queue associated with the S-Tag 802.1p value 0. This option requires two different CAM entries, each in a different Layer 2 ACL FP block.



Note: The ability to map incoming C-Tag dot1p to any S-Tag dot1p requires up to 8 entries to be installed in the Layer 2 QoS and Layer 2 ACL table for each configured customer VLAN. The scalability of this feature is limited by the impact of the 1:8 expansion in these CAM tables.

FTOS Behavior: For Option A above, when there is a conflict between the queue selected by Dynamic Mode CoS (vlan-stack dot1p-mapping) and a QoS configuration, the queue selected by Dynamic Mode CoS takes precedence. However, rate policing for the queue is determined by QoS configuration. For example, the following access-port configuration maps all traffic to Queue 0:

```
vlan-stack dot1p-mapping c-tag-dot1p 0-7 sp-tag-dot1p 1
```

However, if the following QoS configuration also exists on the interface, traffic is queued to Queue 0 but will be rate policed at 40Mbps (qos-policy-input for queue 3) since class-map "a" of Queue 3 also matches the traffic. This behavior is expected.

```
policy-map-input in layer2
service-queue 3 class-map a qos-policy 3
!
class-map match-any a layer2
match mac access-group a
!
mac access-list standard a
seq 5 permit any
!
qos-policy-input 3 layer2
rate-police 40
```

Likewise, in the configuration below, packets with dot1p priority 0 – 3 are marked as dot1p 7 in the outer tag and queued to Queue 3. Rate policing is according to qos-policy-input 3. All other packets will have outer dot1p 0 and hence are queued to Queue 1. They are therefore policed according to qos-policy-input 1.

A policy map output with rate shape for different queues can also be used.

```
policy-map-input in layer2
service-queue 1 qos-policy 1
service-queue 3 qos-policy 3
!
qos-policy-input 1 layer2
rate-police 10
!
qos-policy-input 3 layer2
rate-police 30
!
interface GigabitEthernet 0/21
no ip address
switchport
vlan-stack access
vlan-stack dot1p-mapping c-tag-dot1p 0-3 sp-tag-dot1p 7
service-policy input in layer2
no shutdown
```

To map C-Tag dot1p values to S-Tag dot1p values and mark the frames accordingly:

| Step | Task | Command Syntax | Command Mode |
|------|--|--|----------------|
| 1 | Allocate CAM space to enable queuing frames according to the C-Tag or the S-Tag. vman-qos: mark the S-Tag dot1p and queue the frame according to the original C-Tag dot1p. This method requires half as many CAM entries as vman-qos-dual-fp. vman-qos-dual-fp: mark the S-Tag dot1p and queue the frame according to the S-Tag dot1p. This method requires twice as many CAM entries as vman-qos and FP blocks in multiples of 2. | cam-acl l2acl <i>number</i> ipv4acl <i>number</i> ipv6acl <i>number</i> ipv4qos <i>number</i> l2qos <i>number</i> l2pt <i>number</i> ipmacacl <i>number</i> ecfmacl <i>number</i> {vman-qos vman-qos-dual-fp} <i>number</i> Default: 0 FP blocks for vman-qos and vman-qos-dual-fp | CONFIGURATION |
| 2 | The new CAM configuration is stored in NVRAM and takes effect only after a save and reload. | copy running-config startup-config reload | EXEC Privilege |
| 3 | Map C-Tag dot1p values to a S-Tag dot1p value. C-Tag values may be separated by commas, and dashed ranges are permitted. Dynamic Mode CoS overrides any Layer 2 QoS configuration in case of conflicts. | vlan-stack dot1p-mapping c-tag-dot1p <i>values</i> sp-tag-dot1p <i>value</i> | INTERFACE |

 **Note:** Since dot1p-mapping marks *and* queues packets, the only remaining applicable QoS configuration is rate metering. You may use Rate Shaping or Rate Policing.

Layer 2 Protocol Tunneling

Layer 2 Protocol Tunneling (L2PT) is supported on platforms: **C e S**

Spanning Tree BPDUs use a reserved destination MAC address called the Bridge Group Address, which is 01-80-C2-00-00-00. Only spanning-tree bridges on the LAN recognize this address and process the BPDU. When VLAN stacking is used to connect physically separate regions of a network, BPDUs attempting to traverse the intermediate network might be consumed and subsequently dropped because the intermediate network itself might be using Spanning Tree (Figure 43-13).

Figure 43-13. VLAN Stacking without L2PT

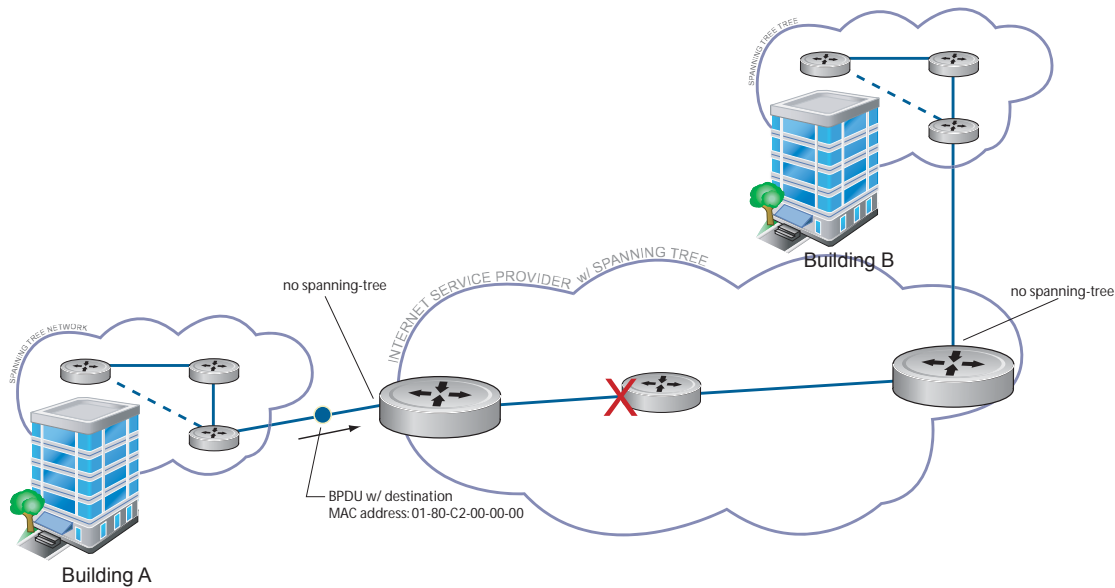

You might need to transport control traffic transparently through the intermediate network to the other region. Layer 2 Protocol Tunneling enables BPDUs to traverse the intermediate network by identifying frames with the Bridge Group Address, rewriting the destination MAC to a user-configured non-reserved address, and forwarding the frames. Since the frames now use a unique MAC address, BPDUs are treated as normal data frames by the switches in the intermediate network core. On egress edge of the intermediate network, the MAC address is rewritten to the original MAC address and forwarded to the opposing network region (Figure 43-14).

FTOS Behavior: In FTOS versions prior to 8.2.1.0, the MAC address that Dell Force10 systems use to overwrite the Bridge Group Address on ingress was non-configurable. The value of the L2PT MAC address was the Dell Force10-unique MAC address, 01-01-e8-00-00-00. As such, with these FTOS versions, Dell Force10 systems are required at the egress edge of the intermediate network because only FTOS could recognize the significance of the destination MAC address and rewrite it to the original Bridge Group Address. In FTOS version 8.2.1.0 and later, the L2PT MAC address is user-configurable, so you can specify an address that non-Dell Force10 systems can recognize and rewrite the address at egress edge.

Figure 43-14. VLAN Stacking with L2PT

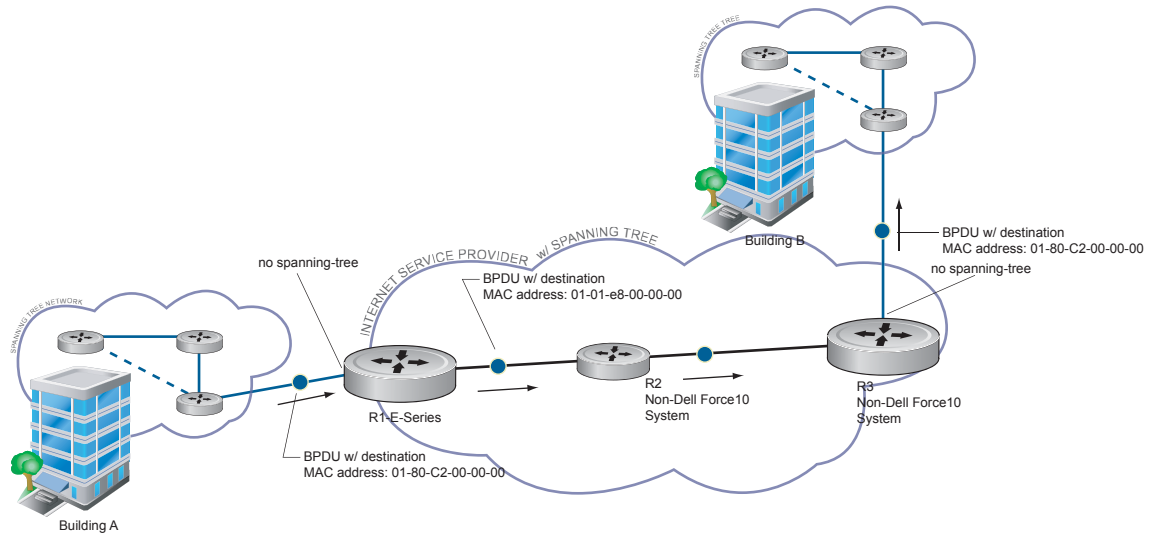

Implementation Information

- L2PT is available for STP, RSTP, MSTP, and PVST+ BPDUs.
- No protocol packets are tunneled when VLAN Stacking is enabled.
- L2PT requires the default CAM profile.

Enable Layer 2 Protocol Tunneling

| Step | Task | Command Syntax | Command Mode |
|------|--|------------------------|-------------------|
| 1 | Verify that the system is running the default CAM profile; you must use this CAM profile for L2PT. | show cam-profile | EXEC Privilege |
| 2 | Enable protocol tunneling globally on the system. | protocol-tunnel enable | CONFIGURATION |
| 3 | Tunnel BPDUs the VLAN. | protocol-tunnel stp | INTERFACE VLAN |

Specify a Destination MAC Address for BPDUs

By default, FTOS uses a Dell Force10-unique MAC address for tunneling BPDUs. You can configure another value.

| Task | Command Syntax | Command Mode |
|---|---------------------------------|---------------|
| Overwrite the BPDU with a user-specified destination MAC address when BPDUs are tunneled across the provider network. Default: 01:01:e8:00:00:00 | protocol-tunnel destination-mac | CONFIGURATION |

Rate-limit BPDUs on the E-Series

In order to rewrite the destination MAC address on BPDUs, they are forwarded to the RPM. You can rate-limit BPDUs to protect the RPM, in which case the system drops BPDUs when the threshold is reached.

| Task | Command Syntax | Command Mode |
|---|----------------------------|---------------|
| Set a maximum rate at which the RPM will process BPDUs for L2PT. Default: 75 pps E-Series Range: 75 to 3000 pps | protocol-tunnel rate-limit | CONFIGURATION |

Rate-limit BPDUs on the C-Series and S-Series

CAM space is allocated in sections called Field Processor (FP) blocks.

There are total 13 user-configurable FP blocks on the C-Series and S-Series. The default number of blocks for L2PT is 0; you must allocate at least one to enable BPDU rate-limiting.

| Step | Task | Command Syntax | Command Mode |
|------|---|------------------------------------|----------------|
| 1 | Create at least one FP group for L2PT. See CAM Allocation on page 268 for details on this command. | cam-acl l2acl | CONFIGURATION |
| 2 | Save the running-config to the startup-config. | copy running-config startup-config | EXEC Privilege |
| 3 | Reload the system. | reload | EXEC Privilege |
| 4 | Set a maximum rate at which the RPM will process BPDUs for L2PT. Default: no rate limiting C-Series Range: 64 to 640 kbps S-Series Range: 64 to 320 kbps | protocol-tunnel rate-limit | VLAN STACKING |

Debug Layer 2 Protocol Tunneling

| Task | Command Syntax | Command Mode |
|---|-----------------------|----------------|
| Display debugging information for L2PT. | debug protocol-tunnel | EXEC Privilege |

Provider Backbone Bridging

Provider Backbone Bridging is supported only on platforms: **C S**

IEEE 802.1ad—Provider Bridges amends 802.1Q—Virtual Bridged Local Area Networks so that service providers can use 802.1Q architecture to offer separate VLANs to customers with no coordination between customers, and minimal coordination between customers and the provider.

802.1ad specifies that provider bridges operating Spanning Tree use a reserved destination MAC address called the Provider Bridge Group Address, 01-80-C2-00-00-08, to exchange BPDUs instead of the Bridge Group Address, 01-80-C2-00-00-00, originally specified in 802.1Q. Only bridges in the service provider network use this destination MAC address so these bridges treat BPDUs originating from the customer network as normal data frames, rather than consuming them.

The same is true for GVRP. 802.1ad specifies that provider bridges participating in GVRP use a reserved destination MAC address called the Provider Bridge GVRP Address, 01-80-C2-00-00-0D, to exchange GARP PDUs instead of the GVRP Address, 01-80-C2-00-00-21, specified in 802.1Q. Only bridges in the service provider network use this destination MAC address so these bridges treat GARP PDUs originating from the customer network as normal data frames, rather than consuming them.

Provider Backbone Bridging through IEEE 802.1ad eliminates the need for tunneling BPDUs with L2PT and increases the reliability of provider bridge networks as the network core need only learn the MAC addresses of core switches, as opposed to all MAC addresses received from attached customer devices.

| Task | Command Syntax | Command Mode |
|---|--|---------------|
| Use the Provider Bridge Group address as the destination MAC address in BPDUs. The xstp keyword applies this functionality to STP, RSTP, and MSTP; this functionality is not available for PVST+. | bpdu-destination-mac-address [stp gvrp] provider-bridge-group | CONFIGURATION |

sFlow

Configuring sFlow is supported on platforms: e C S **S4810** **S4820T**

- [Enable and Disable sFlow](#)
- [sFlow Show Commands](#)
- [Specify Collectors](#)
- [Polling Intervals](#)
- [Sampling Rate](#)
- [Back-off Mechanism](#)
- [sFlow on LAG ports](#)
- [Extended sFlow](#)

Overview

FTOS supports sFlow version 5. sFlow is a standard-based sampling technology embedded within switches and routers which is used to monitor network traffic. It is designed to provide traffic monitoring for high speed networks with many switches and routers. sFlow uses two types of sampling:

- Statistical packet-based sampling of switched or routed packet flows
- Time-based sampling of interface counters

The sFlow monitoring system consists of an sFlow Agent (embedded in the switch/router) and an sFlow collector. The sFlow Agent resides anywhere within the path of the packet, and combines the flow samples and interface counters into sFlow datagrams and forwards them to the sFlow Collector at regular intervals. The datagrams consists of information on, but not limited to, packet header, ingress and egress interfaces, sampling parameters, and interface counters.

Packet sampling is typically done by the ASIC. sFlow Collector analyses the sFlow datagrams received from different devices and produces a network-wide view of traffic flows.

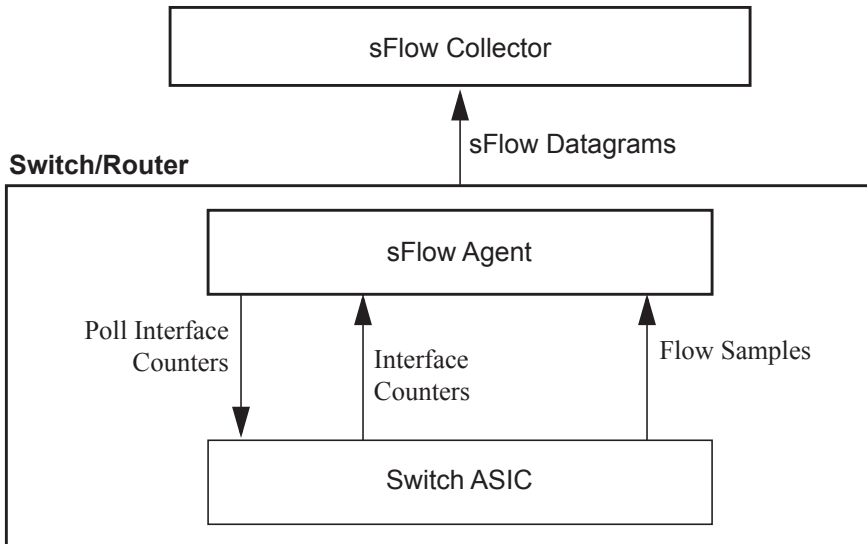
Figure 44-1. sFlow Traffic Monitoring System

Implementation Information

The Dell Force10 sFlow is designed so that the hardware sampling rate is per line card port-pipe and is decided based upon all the ports in that port-pipe. If sFlow is not enabled on any port specifically, then the global sampling rate is downloaded to that port and is to calculate the port-pipe's lowest sampling rate. This design supports, then, the possibility that sFlow might be configured on that port in the future. Back-off is triggered based on the port-pipe's hardware sampling rate.

For example, if port 1 in the port-pipe has sFlow configured with a 16384 sampling rate while port 2 in the port-pipe has sFlow configured but no sampling rate set, FTOS applies a global sampling rate of 512 to port 2. The hardware sampling rate on the port-pipe is then set at 512 because that is the lowest configured rate on the port-pipe. When a high traffic situation occurs, a back-off is triggered and the hardware sampling rate is backed-off from 512 to 1024. Note that port 1 maintains its sampling rate of 16384; port 1 is unaffected because it maintains its configured sampling rate of 16384.

To avoid the back-off, either increase the global sampling rate or configure all the line card ports with the desired sampling rate even if some ports have no sFlow configured.

Important Points to Remember

- The FTOS implementation of the sFlow MIB supports sFlow configuration via `snmpset`.
- Collection through management interface is supported on E-Series only
- Dell Force10 recommends that the sFlow Collector be connected to the Dell Force10 chassis through a line card port rather than the RPM Management Ethernet port.
- E-Series TeraScale sFlow sampling is done on a per-port-pipe basis.
- E-Series ExaScale, C-Series, and S-Series sFlow sampling is done on a per-port basis.

- FTOS exports all sFlow packets to the collector. A small sampling rate can equate to a large number of exported packets. A backoff mechanism will automatically be applied to reduce this amount. Some sampled packets may be dropped when the exported packet rate is high and the backoff mechanism is about to or is starting to take effect. The dropEvent counter, in the sFlow packet, will always be zero.
- Community list and local preference fields are not filled in extended gateway element in sFlow datagram.
- 802.1P source priority field is not filled in extended switch element in sFlow datagram.
- Only Destination and Destination Peer AS number are packed in the dst-as-path field in extended gateway element
- If packet being sampled is redirected using PBR (Policy-Based Routing), sFlow datagram may contain incorrect extended gateway/router information.
- Source VLAN field in the extended switch element will not be packed in case of routed packet.
- Destination VLAN field in the extended switch element will not be packed in case of Multicast packet.
- On the S-Series, up to 700 packets can be sampled and processed per second.
- On the C-Series up to 1000 packets can be sampled and processed per second.
- On the E-Series, the maximum number of packets that can be sampled and processed per second is:
 - 7500 packets when no extended information packing is enabled.
 - 1000 packets when only extended-switch information packing is enabled.
 - 1600 packets when extended-router and/or extended-gateway information packing is enabled.

Enable and Disable sFlow

By default, sFlow is *disabled* globally on the system. To enable sFlow globally, use the **sflow enable** command in CONFIGURATION mode. Use the no version of this command to disable sFlow globally.

| Command Syntax | Command Mode | Usage |
|-------------------|---------------|------------------------|
| [no] sflow enable | CONFIGURATION | Enable sFlow globally. |

Enable and Disable on an Interface

By default, sFlow is *disabled* on all interfaces. To enable sFlow on a specific interface, use the **sflow enable** command in INTERFACE mode. Use the no version of this command to disable sFlow on an interface. This CLI is supported on physical ports and LAG ports.

| Command Syntax | Command Mode | Usage |
|-------------------|--------------|-------------------------------|
| [no] sflow enable | INTERFACE | Enable sFlow on an interface. |

sFlow Show Commands

FTOS includes the following sFlow display commands:

- [Show sFlow Globally](#)
- [Show sFlow on an Interface](#)
- [Show sFlow on a Line Card](#)

Show sFlow Globally

Use the following command to view sFlow statistics:

| Command Syntax | Command Mode | Purpose |
|-------------------------|--------------|---|
| <code>show sflow</code> | EXEC | Display sFlow configuration information and statistics. |

Figure 44-2 is a sample output from the `show sflow` command:

Figure 44-2. Command Example: show sflow

```

FTOS#show sflow
sFlow services are enabled
Global default sampling rate: 32768
Global default counter polling interval: 20
1 collectors configured
Collector IP addr: 133.33.33.53, Agent IP addr: 133.33.33.116, UDP port: 6343
77 UDP packets exported
0 UDP packets dropped
165 sFlow samples collected
69 sFlow samples dropped due to sub-sampling

Linecard 1 Port set 0 H/W sampling rate 8192
  Gi 1/16: configured rate 8192, actual rate 8192, sub-sampling rate 1
  Gi 1/17: configured rate 16384, actual rate 16384, sub-sampling rate 2
  
```

Indicates sFlow is globally enabled

Indicates sFlow is enabled on linecards Gi 1/16 and Gi 1/17

Show sFlow on an Interface

Use the following command to view sFlow information on a specific interface:

| Command Syntax | Command Mode | Purpose |
|--|--------------|---|
| <code>show sflow interface interface-name</code> | EXEC | Display sFlow configuration information and statistics on a specific interface. |

Figure 44-3 is a sample output from the `show sflow interface` command.

Figure 44-3. Command Example: show sflow interface

```
FTOS#show sflow interface gigabitethernet 1/16
Gi 1/16
Configured sampling rate      :8192
Actual sampling rate         :8192
Sub-sampling rate            :2
Counter polling interval     :15
Samples rcvd from h/w        :33
Samples dropped for sub-sampling :6
```

The configuration, shown in [Figure 44-2](#), is also displayed in the running configuration ([Figure 44-4](#)):

Figure 44-4. Command Example: show running-config interface

```
FTOS#show running-config interface gigabitethernet 1/16
!
interface GigabitEthernet 1/16
 no ip address
 mtu 9252
 ip mtu 9234
 switchport
 sflow enable
 sflow sample-rate 8192
 no shutdown
```

Show sFlow on a Line Card

Use the following command to view sFlow statistics on a specified line card:

| Command Syntax | Command Mode | Purpose |
|---|--------------|--|
| show sflow linecard <i>slot-number</i> | EXEC | Display sFlow configuration information and statistics on the specified interface. |

[Figure 44-5](#) is a sample output from the show sflow linecard command:

Figure 44-5. Command Example: show sflow linecard

```
FTOS#show sflow linecard 1
Linecard 1
Samples rcvd from h/w        :165
Samples dropped for sub-sampling :69
Total UDP packets exported   :77
UDP packets exported via RPM :77
UDP packets dropped          :
```

Specify Collectors

The **sflow collector** command allows identification of sFlow Collectors to which sFlow datagrams are forwarded. The user can specify up to two sFlow collectors. If two Collectors are specified, the samples are sent to both.

Collection through Management interface is supported on platform: **e** .

| Command Syntax | Command Mode | Usage |
|---|---------------|--|
| sflow collector <i>ip-address</i> agent-addr <i>ip-address</i> [<i>number</i> [max-datagram-size <i>number</i>]] [max-datagram-size <i>number</i>] | CONFIGURATION | Identify sFlow collectors to which sFlow datagrams are forwarded. Default UDP port: 6343 Default max-datagram-size: 1400 |

Polling Intervals

The **sflow polling-interval** command configures the polling interval for an interface in the maximum number of seconds between successive samples of counters to be sent to the collector. This command changes the global default counter polling (20 seconds) interval. You can configure an interface to use a different polling interval.

The polling interval can be configured globally (in CONFIGURATION mode) or by interface (in INTERFACE mode) by executing the interval command:

| Command Syntax | Command Mode | Usage |
|---|-------------------------------|--|
| sflow polling-interval <i>interval value</i> | CONFIGURATION or INTERFACE | Change the global default counter polling interval. <i>interval value</i> —in seconds. Range: 15 to 86400 seconds Default: 20 seconds |

Sampling Rate

Sampling Rate is supported on platform **e** _t

The sFlow sampling rate is the number of packets that are skipped before the next sample is taken. sFlow does not have time-based packet sampling.

The **sflow sample-rate** command, when issued in CONFIGURATION mode, changes the default sampling rate. By default, the sampling rate of an interface is set to the same value as the current global default sampling rate. If the value entered is not a correct power of 2, the command generates an error message with the previous and next power-of-2 value. Select one of these two number and re-enter the command. (For more information on values in power-of-2, see [Sub-sampling on page 881](#).)

The sample rate can be configured globally or by interface using the sample rate command:

| Command Syntax | Command Mode | Usage |
|---|----------------------------------|--|
| [no] sflow sample-rate <i>sample-rate</i> | CONFIGURATION or INTERFACE | Change the global or interface sampling rate. Rate must be entered in factors of 2 (eg, 4096, 8192). <i>sample-rate</i> range: 256-8388608 for C-Series and S-Series 2-8388608 for E-Series |

Sub-sampling

[Sub-sampling](#) is available only on platform: E t

The sFlow sample rate is not the frequency of sampling, but the number of packets that are skipped before the next sample is taken. Although a sampling rate can be configured for each port, TeraScale line cards can support only a single sampling rate per port-pipe.

Therefore, sFlow Agent uses sub-sampling to create multiple sampling rates per port-pipe. To achieve different sampling rates for different ports in a port-pipe, sFlow Agent takes the lowest numerical value of the sampling rate of all the ports within the port-pipe, and configures all ports to this value. sFlow Agent is then able to skip samples on ports where you require a larger sampling rate value.

Sampling rates are configurable in powers of two. This allows the smallest sampling rate possible to be configured on the hardware, and also allows all other sampling rates to be available through sub-sampling.

For example, if Gig 1/0 and 1/1 are in a port-pipe, and they are configured with a sampling rate of 4096 on interface Gig 1/0, and 8192 on Gig 1/1, sFlow Agent does the following:

1. Configures the hardware to a sampling rate of 4096 for all ports with sFlow enabled on that port-pipe.
2. Configure interface Gig 1/0 to a sub-sampling rate of 1 to achieve an actual rate of 4096.
3. Configure interface Gig 1/1 to a sub-sampling rate of 2 to achieve an actual rate of 8192.



Note: Sampling rate backoff can change the sampling rate value that is set in the hardware. This equation shows the relationship between actual sampling rate, sub-sampling rate, and the hardware sampling rate for an interface:

$$\text{Actual sampling rate} = \text{sub-sampling rate} * \text{hardware sampling rate}$$

Note the absence of a configured rate in the equation. That is because when the hardware sampling rate value on the port-pipe exceeds the configured sampling rate value for an interface, the actual rate changes to the hardware rate. The sub-sampling rate never goes below a value of one.

Back-off Mechanism

If the sampling rate for an interface is set to a very low value, the CPU can get overloaded with flow samples under high-traffic conditions. In such a scenario, a binary back-off mechanism gets triggered, which doubles the sampling-rate (halves the number of samples per second) for all interfaces. The backoff mechanism continues to double the sampling-rate until CPU condition is cleared. This is as per sFlow version 5 draft. Once the back-off changes the sample-rate, users must manually change the sampling rate to the desired value.

As a result of back-off, the actual sampling-rate of an interface may differ from its configured sampling rate. The actual sampling-rate of the interface and the configured sample-rate can be viewed by using the `show sflow` command.

sFlow on LAG ports

When a physical port becomes a member of a LAG, it inherits the sFlow configuration from the LAG port.

Extended sFlow

Extended sFlow is supported fully on platform **E**

Platforms **C** and **S** support extended-switch information processing *only*.

Extended sFlow packs additional information in the sFlow datagram depending on the type of sampled packet. The following options can be enabled:

- extended-switch — 802.1Q VLAN ID and 802.1p priority information
- extended-router — Next-hop and source and destination mask length.
- extended-gateway — Source and destination AS number and the BGP next-hop.



Note: The entire AS path is not included. BGP community-list and local preference information are not included. These fields are assigned default values and are not interpreted by the collector.

Use the command `sflow [extended-switch] [extended-router] [extended-gateway] enable` command. By default packing of any of the extended information in the datagram is disabled.

Use the command `show sflow` to confirm that extended information packing is enabled, as shown in [Figure 44-6](#).

Figure 44-6. Confirming that Extended sFlow is Enabled

```
FTOS#show sflow
sFlow services are enabled
Global default sampling rate: 4096
Global default counter polling interval: 15
Global extended information enabled: gateway, router, switch
1 collectors configured
Collector IP addr: 10.10.10.3, Agent IP addr: 10.10.0.0, UDP port: 6343
77 UDP packets exported
0 UDP packets dropped
165 sFlow samples collected
69 sFlow samples dropped due to sub-sampling

Linecard 1 Port set 0 H/W sampling rate 8192
  Gi 1/16: configured rate 8192, actual rate 8192, sub-sampling rate 1
  Gi 1/17: configured rate 16384, actual rate 16384, sub-sampling rate 2

Linecard 3 Port set 1 H/W sampling rate 16384
  Gi 3/40: configured rate 16384, actual rate 16384, sub-sampling rate 1
```

Extended sFlow settings show all 3 types are enabled

If none of the extended information is enabled, the show output is as shown in [Figure 44-7](#).

Figure 44-7. Confirming that Extended sFlow is Disabled

```
FTOS#show sflow
sFlow services are disabled
Global default sampling rate: 32768
Global default counter polling interval: 20
Global extended information enabled: none
0 collectors configured
0 UDP packets exported
0 UDP packets dropped
0 sFlow samples collected
0 sFlow samples dropped due to sub-sampling
```

Indicates no Extended sFlow types enabled.

Important Points to Remember

- The IP destination address has to be learned via BGP in order to export extended-gateway data, prior to FTOS version 7.8.1.0.
- If the IP destination address is not learned via BGP the Dell Force10 system does not export extended-gateway data, prior to FTOS version 7.8.1.0.
- FTOS 7.8.1.0 and later enhances the sFlow implementation for real time traffic analysis on the E-Series to provide extended gateway information in cases where the destination IP addresses are learned by different routing protocols, and for cases where the destination is reachable over ECMP.
- If the IP source address is learned via IGP then *srcAS* and *srcPeerAS* are zero.
- The *srcAS* and *srcPeerAS* might be zero even though the IP source address is learned via BGP. The c system packs the *srcAS* and *srcPeerAS* information only if the route is learned via BGP and it is reachable via the ingress interface of the packet.

The previous points are summarized in following table.

Table 44-1. Extended Gateway Summary

| IP SA | IP DA | srcAS and srcPeerAS | dstAS and dstPeerAS | Description |
|----------------------|----------------------|---------------------|---------------------|--|
| static/connected/IGP | static/connected/IGP | — | — | Extended gateway data is not exported because there is no AS information. |
| static/connected/IGP | BGP | 0 | Exported | src_as & src_peer_as are zero because there is no AS information for IGP. |
| BGP | static/connected/IGP | — | — | Prior to FTOS version 7.8.1.0, extended gateway data is not be exported because IP DA is not learned via BGP. |
| | | Exported | Exported | 7.8.1.0 allows extended gateway information in cases where the source and destination IP addresses are learned by different routing protocols, and for cases where is source is reachable over ECMP. |
| BGP | BGP | Exported | Exported | Extended gateway data is packed. |

Simple Network Management Protocol (SNMP)

Simple Network Management Protocol (SNMP) is supported on platforms: e C S **S4810**

S4820T

SNMP is supported on the E-Series ExaScale platform with FTOS 8.1.1.0 and later.



Note: On Dell Force10 routers, standard and private SNMP MIBs are supported, including all Get and a limited number of Set operations (such as **set vlan** and **copy cmd**).

Protocol Overview

Network management stations use Simple Network Management Protocol (SNMP) to retrieve or alter management data from network elements. A datum of management information is called a *managed object*; the value of a managed object can be static or variable. Network elements store managed objects in a database called a *Management Information Base* (MIB).

MIBs are hierarchically structured and use *object identifiers* to address managed objects, but managed objects also have a textual name called an *object descriptor*.

Implementation Information

- FTOS supports SNMP version 1 as defined by RFC 1155, 1157, and 1212, SNMP version 2c as defined by RFC 1901, and SNMP version 3 as defined by RFC 2571.
- FTOS supports up to 16 trap receivers.
- The FTOS implementation of the sFlow MIB supports sFlow configuration via SNMP sets.
- SNMP traps for STP and MSTP state changes are based on BRIDGE MIB (RFC 1483) for STP and IEEE 802.1 *draft ruzin-mstp-mib-02* for MSTP.

Configure Simple Network Management Protocol



Note: The configurations in this chapter use a UNIX environment with net-snmp version 5.4. This is only one of many RFC-compliant SNMP utilities you can use to manage your Dell Force10 system using SNMP. Also, these configurations use SNMP version 2c.

Configuring SNMP version 1 or version 2 requires only a single step:

1. Create a community. See [page 887](#).

Configuring SNMP version 3 requires you to configure SNMP users in one of three methods. See [Setting Up User-based Security \(SNMPv3\)](#).

Related Configuration Tasks

The following list contains configuration tasks for SNMP:

- [Managing Overload on Startup](#)
- [Read Managed Object Values](#)
- [Write Managed Object Values](#)
- [Subscribe to Managed Object Value Updates using SNMP](#)
- [Copy Configuration Files Using SNMP](#)
- [Manage VLANs using SNMP](#)
- [Enable and Disable a Port using SNMP](#)
- [Fetch Dynamic MAC Entries using SNMP](#)
- [Deriving Interface Indices](#)
- [Monitor Port-channels](#)

Important Points to Remember

- Typically, 5-second timeout and 3-second retry values on an SNMP server are sufficient for both LAN and WAN applications. If you experience a timeout with these values, increase the timeout value to greater than 3 seconds, and increase the retry value to greater than 2 on your SNMP server.
- User ACLs override group ACLs.

Setting up SNMP

As previously stated, FTOS supports SNMP version 1 and version 2 which are community-based security models. The primary difference between the two versions is that version 2 supports two additional protocol operations (informs operation and **snmpgetbulk** query) and one additional object (counter64 object).

SNMP version 3 (SNMPv3) is a user-based security model that provides password authentication for user security and encryption for data security and privacy. Three sets of configurations are available for SNMP read/write operations: no password or privacy, password privileges, password and privacy privileges

A maximum of 16 users can be configured even if they are in different groups.

Create a Community

For SNMPv1 and SNMPv2, you must create a community to enable the community-based security in FTOS. The management station generates requests to either retrieve or alter the value of a management object and is called the *SNMP manager*. A network element that processes SNMP requests is called an *SNMP agent*. An *SNMP community* is a group of SNMP agents and managers that are allowed to interact. Communities are necessary to secure communication between SNMP managers and agents; SNMP agents do not respond to requests from management stations that are not part of the community.

FTOS enables SNMP automatically when you create an SNMP community and displays [Message 1](#). You must specify whether members of the community may only retrieve values (read), or retrieve and alter values (read-write).

To create an SNMP community:

| Task | Command | Command Mode |
|----------------------------------|---|---------------|
| Choose a name for the community. | <code>snmp-server community name {ro rw}</code> | CONFIGURATION |

Message 1 SNMP Enabled

```
22:31:23: %RPM1-P:CP %SNMP-6-SNMP_WARM_START: Agent Initialized - SNMP WARM_START.
```

View your SNMP configuration, using the command `show running-config snmp` from EXEC Privilege mode, as shown in [Figure 45-1](#).

Figure 45-1. Creating an SNMP Community

```
FTOS (conf) #snmp-server community my-snmp-community ro
22:31:23: %RPM1-P:CP %SNMP-6-SNMP_WARM_START: Agent Initialized - SNMP WARM_START.
FTOS#show running-config snmp
!
snmp-server community mycommunity ro
```

Setting Up User-based Security (SNMPv3)

When setting up SNMPv3, you can set users up with one of the following three types of configuration for SNMP read/write operations. Users are typically associated to an SNMP group with permissions provided, such as OID view.

- **noauth**: no password or privacy. Select this option to set a user up with no password or privacy privileges. This is the basic configuration. Users must have a group and profile that do not require password privileges.
- **auth**: password privileges. Select this option to set up an user with password authentication
- **priv**: password and privacy privileges. Select this option to set up a user with password and privacy privileges.

Figure 45-2. Select a User-based Security Type

```
FTOS(conf)#snmp-server host 1.1.1.1 traps {oid tree} version 3 ?
auth                Use the SNMPv3 authNoPriv Security Level
noauth              Use the SNMPv3 noAuthNoPriv Security Level
priv                Use the SNMPv3 authPriv Security Level
FTOS(conf)#snmp-server host 1.1.1.1 traps {oid tree} version 3 noauth ?
WORD                SNMPv3 user name
```

To set up a user with view privileges only (no password or privacy privileges):

| Task | Command | Command Mode |
|---------------------------|--|---------------|
| Configure the user. | snmp-server user <i>name group-name 3 noauth</i> | CONFIGURATION |
| Configure an SNMP group. | snmp-server group <i>group-name 3 noauth auth read name write name</i> | CONFIGURATION |
| Configure an SNMPv3 view. | snmp-server view <i>view-name oid-tree {included excluded}</i> Note: To give a user read and write view privileges, repeat this step for each privilege type. | CONFIGURATION |

To set up a user with password privileges only, use the following commands:

| Task | Command | Command Mode |
|---|---|---------------|
| Configure the user with an authorization password | snmp-server user <i>name group-name 3 noauth auth md5 auth-password</i> | CONFIGURATION |
| Configure an SNMP group. | snmp-server group <i>groupname {oid-tree} auth read name write name</i> | CONFIGURATION |
| Configure an SNMPv3 view. | snmp-server view <i>view-name 3 noauth {included excluded}</i> Note: To give a user read and write privileges, repeat this step for each privilege type. | CONFIGURATION |

To set up a user with password or privacy privileges:

| Task | Command | Command Mode |
|--------------------------|---|---------------|
| Configure an SNMP group. | snmp-server group <i>group-name {oid-tree} priv read name write name</i> | CONFIGURATION |

| Task | Command | Command Mode |
|---|---|---------------|
| Configure the user with a secure authorization password and privacy password. | snmp-server user <i>name group-name {oid-tree} auth md5 auth-password priv des56 priv password</i> | CONFIGURATION |
| Configure an SNMPv3 view. | snmp-server view <i>view-name oid-tree {included excluded}</i> | CONFIGURATION |

Read Managed Object Values

You may only retrieve (read) managed object values if your management station is a member of the same community as the SNMP agent.

Dell Force10 supports RFC 4001, *Textual Conventions for Internet Work Addresses* that defines values representing a type of internet address. These values display for `ipAddressTable` objects using the `snmpwalk` command.

In the following figure, the value “4” displays in the OID before the IP address for IPv4. For an IPv6 IP address), a value of “16” displays.

```
>snmpwalk -v 2c -c public 10.11.195.63 1.3.6.1.2.1.4.34
IP-MIB::ip.34.1.3.1.4.1.1.1.1 = INTEGER: 1107787778
IP-MIB::ip.34.1.3.1.4.2.1.1.1 = INTEGER: 1107787779
IP-MIB::ip.34.1.3.2.16.0.1.0.0.0.0.0.0.0.0.0.0.0.0.0.0.1 = INTEGER: 1107787778
IP-MIB::ip.34.1.3.2.16.0.2.0.0.0.0.0.0.0.0.0.0.0.0.0.0.1 = INTEGER: 1107787779
IP-MIB::ip.34.1.3.2.16.254.128.0.0.0.0.0.0.0.2.1.232.255.254.139.5.8 = INTEGER: 1107787778
IP-MIB::ip.34.1.4.1.4.1.1.1.1 = INTEGER: 1
IP-MIB::ip.34.1.4.1.4.2.1.1.1 = INTEGER: 1
IP-MIB::ip.34.1.4.2.16.0.1.0.0.0.0.0.0.0.0.0.0.0.0.0.0.1 = INTEGER: 1
```

There are several UNIX SNMP commands that read data:

| Task | Command |
|---|---|
| Read the value of a single managed object, as shown in Figure 45-3 . | snmpget -v version -c community agent-ip {identifier.instance descriptor.instance} |
| Figure 45-3. Reading the Value of a Managed Object | |
| <pre>> snmpget -v 2c -c mycommunity 10.11.131.161 sysUpTime.0 DISMAN-EVENT-MIB::sysUpTimeInstance = Timeticks: (32852616) 3 days, 19:15:26.16 > snmpget -v 2c -c mycommunity 10.11.131.161 .1.3.6.1.2.1.1.3.0</pre> | |
| Read the value of the managed object directly below the specified object, as shown in Figure 45-4 . | snmpgetnext -v version -c community agent-ip {identifier.instance descriptor.instance} |

| Task | Command |
|------|---------|
|------|---------|

Figure 45-4. Reading the Value of the Next Managed Object in the MIB

```
> snmpgetnext -v 2c -c mycommunity 10.11.131.161 .1.3.6.1.2.1.1.3.0
SNMPv2-MIB::sysContact.0 = STRING:
> snmpgetnext -v 2c -c mycommunity 10.11.131.161 sysContact.0
```

| | |
|---|--|
| Read the value of many objects at once, as shown in Figure 45-5 . | <code>snmpwalk -v version -c community agent-ip {identifier.instance descriptor.instance}</code> |
|---|--|

Figure 45-5. Reading the Value of Many Managed Objects at Once

```
> snmpwalk -v 2c -c mycommunity 10.11.131.161 .1.3.6.1.2.1.1
SNMPv2-MIB::sysDescr.0 = STRING: Dell Force10 Real Time Operating System Software
Dell Force10 Operating System Version: 1.0
Dell Force10 Application Software Version: E_MAIN4.7.6.350
Copyright (c) 1999-2007 by Dell Force10
Build Time: Mon May 12 14:02:22 PDT 2008
SNMPv2-MIB::sysObjectID.0 = OID: SNMPv2-SMI::enterprises.6027.1.3.1
DISMAN-EVENT-MIB::sysUpTimeInstance = Timeticks: (32920954) 3 days, 19:26:49.54
SNMPv2-MIB::sysContact.0 = STRING:
```

Write Managed Object Values

You may only alter (write) a managed object value if your management station is a member of the same community as the SNMP agent, and the object is writable.

To write or write-over the value of a managed object:

| Task | Command |
|------|---------|
|------|---------|

| | |
|---|--|
| To write or write-over the value of a managed object, as shown in Figure 45-6 . | <code>snmpset -v version -c community agent-ip {identifier.instance descriptor.instance} syntax value</code> |
|---|--|

Figure 45-6. Writing over the Current Value of a Managed Object

```
> snmpset -v 2c -c mycommunity 10.11.131.161 sysName.0 s "R5"
SNMPv2-MIB::sysName.0 = STRING: R5
```

Configure Contact and Location Information using SNMP

You may configure system contact and location information from the Dell Force10 system or from the management station using SNMP.

To configure system contact and location information from the Dell Force10 system:

| Task | Command | Command Mode |
|---|---|---------------|
| Identify the system manager along with this person's contact information (e.g., E-mail address or phone number). You may use up to 55 characters. Default: None | snmp-server contact <i>text</i> | CONFIGURATION |
| Identify the physical location of the system. For example, San Jose, 350 Holger Way, 1st floor lab, rack A1-1. You may use up to 55 characters. Default: None | snmp-server location <i>text</i> | CONFIGURATION |

To configure the system from the management station using SNMP:

| Task | Command | Command Mode |
|---|--|---------------|
| Identify the system manager along with this person's contact information (e.g., E-mail address or phone number). You may use up to 55 characters. Default: None | snmpset -v <i>version -c community agent-ip sysContact.0 s "contact-info"</i> | CONFIGURATION |
| Identify the physical location of the system. For example, San Jose, 350 Holger Way, 1st floor lab, rack A1-1. You may use up to 55 characters. Default: None | snmpset -v <i>version -c community agent-ip sysLocation.0 s "location-info"</i> | CONFIGURATION |

Subscribe to Managed Object Value Updates using SNMP

By default, the Dell Force10 system displays some unsolicited SNMP messages (traps) upon certain events and conditions. You can also configure the system to send the traps to a management station. Traps cannot be saved on the system.

FTOS supports the following three sets of traps:

- **RFC 1157-defined traps:** coldStart, warmStart, linkDown, linkUp, authenticationFailure, egpNeighborLoss
- **Force10 enterpriseSpecific environment traps:** fan, supply, temperature
- **Force10 enterpriseSpecific protocol traps:** bgp, ecfm, stp, xstp

To configure the system to send SNMP notifications:

| Step | Task | Command | Command Mode |
|------|---|---|---------------|
| 1 | Configure the Dell Force10 system to send notifications to an SNMP server. <ul style="list-style-type: none"> Enter the keyword traps to send trap messages. Enter the keyword informs to send informational messages. Enter the keyword version to send the SNMP version to use for notification messages. Enter the name of the <i>community-string</i> to identify the SNMPv1 community string. | snmp-server host <i>ip-address</i> [traps informs] [version 1 2c 3] [<i>community-string</i>] | CONFIGURATION |
| 2 | Specify which traps the Dell Force10 system sends to the trap receiver. <ul style="list-style-type: none"> Enable all Dell Force10 enterpriseSpecific and RFC-defined traps using the command snmp-server enable traps from CONFIGURATION mode. Enable all of the RFC-defined traps using the command snmp-server enable traps snmp from CONFIGURATION mode. | snmp-server enable traps | CONFIGURATION |
| 3 | Specify the interfaces out of which FTOS sends SNMP traps. | snmp-server trap-source | CONFIGURATION |

Table 45-1 lists the traps the RFC-defined SNMP traps and the command used to enable each. Note that the coldStart and warmStart traps are enabled using a single command.

Table 45-1. RFC 1157 Defined SNMP Traps on FTOS

| Command Option | Trap |
|---------------------|--|
| snmp authentication | SNMP_AUTH_FAIL:SNMP Authentication failed.Request with invalid community string. |
| snmp coldstart | SNMP_COLD_START: Agent Initialized - SNMP COLD_START. SNMP_WARM_START: Agent Initialized - SNMP WARM_START. |
| snmp linkdown | PORT_LINKDN:changed interface state to down:%d |
| snmp linkup | PORT_LINKUP:changed interface state to up:%d |

Enable a subset of Dell Force10 enterprise specific SNMP traps using one of the listed command options in Table 45-2 with the command **snmp-server enable traps**. Note that the **envmon** option enables all environment traps including those that are enabled with the **envmon supply**, **envmon temperature**, and **envmon fan** options.

Table 45-2. Dell Force10 Enterprise-specific SNMP Traps

| Command Option | Trap |
|----------------|--|
| envmon | CARD_SHUTDOWN: %sLine card %d down - %s CARD_DOWN: %sLine card %d down - %s LINECARDUP: %sLine card %d is up CARD_MISMATCH: Mismatch: line card %d is type %s - type %s required. |

Table 45-2. Dell Force10 Enterprise-specific SNMP Traps

| Command Option | Trap |
|----------------|--|
| | RPM_STATE: RPM1 is in Active State |
| | RPM_STATE: RPM0 is in Standby State |
| | RPM_DOWN: RPM 0 down - hard reset |
| | RPM_DOWN: RPM 0 down - card removed |
| | HOT_FAILOVER: RPM Failover Completed |
| | SFM_DISCOVERY: Found SFM 1 |
| | SFM_REMOVE: Removed SFM 1 |
| | MAJOR_SFM: Major alarm: Switch fabric down |
| | MAJOR_SFM_CLR: Major alarm cleared: Switch fabric up |
| | MINOR_SFM: Minor alarm: No working standby SFM |
| | MINOR_SFM_CLR: Minor alarm cleared: Working standby SFM present |
| | TASK SUSPENDED: SUSPENDED - svce:%d - inst:%d - task:%s |
| | RPM0-P:CP %CHMGR-2-CARD_PARITY_ERR |
| | ABNORMAL_TASK_TERMINATION: CRASH - task:%s %s |
| | CPU_THRESHOLD: Cpu %s usage above threshold. Cpu5SecUsage (%d) |
| | CPU_THRESHOLD_CLR: Cpu %s usage drops below threshold. Cpu5SecUsage (%d) |
| | MEM_THRESHOLD: Memory %s usage above threshold. MemUsage (%d) |
| | MEM_THRESHOLD_CLR: Memory %s usage drops below threshold. MemUsage (%d) |
| | DETECT_STN_MOVE: Station Move threshold exceeded for Mac %s in vlan %d |
| | CAM-UTILIZATION: Enable SNMP envmon CAM utilization traps. |

Table 45-2. Dell Force10 Enterprise-specific SNMP Traps

| Command Option | Trap |
|--------------------|---|
| envmon supply | <p>PEM_PRBLM: Major alarm: problem with power entry module %s</p> <p>PEM_OK: Major alarm cleared: power entry module %s is good</p> <p>MAJOR_PS: Major alarm: insufficient power %s</p> <p>MAJOR_PS_CLR: major alarm cleared: sufficient power</p> <p>MINOR_PS: Minor alarm: power supply non-redundant</p> <p>MINOR_PS_CLR: Minor alarm cleared: power supply redundant</p> |
| envmon temperature | <p>MINOR_TEMP: Minor alarm: chassis temperature</p> <p>MINOR_TEMP_CLR: Minor alarm cleared: chassis temperature normal (%s %d temperature is within threshold of %dC)</p> <p>MAJOR_TEMP: Major alarm: chassis temperature high (%s temperature reaches or exceeds threshold of %dC)</p> <p>MAJOR_TEMP_CLR: Major alarm cleared: chassis temperature lower (%s %d temperature is within threshold of %dC)</p> |
| envmon fan | <p>FAN_TRAY_BAD: Major alarm: fantray %d is missing or down</p> <p>FAN_TRAY_OK: Major alarm cleared: fan tray %d present</p> <p>FAN_BAD: Minor alarm: some fans in fan tray %d are down</p> <p>FAN_OK: Minor alarm cleared: all fans in fan tray %d are good</p> |
| vlt | Enable VLT traps. |
| vrrp | Enable VRRP state change traps |
| xstp | <p>%SPANMGR-5-STP_NEW_ROOT: New Spanning Tree Root, Bridge ID Priority 32768, Address 0001.e801.fc35.</p> <p>%SPANMGR-5-STP_TOPOLOGY_CHANGE: Bridge port GigabitEthernet 11/38 transitioned from Forwarding to Blocking state.</p> <p>%SPANMGR-5-MSTP_NEW_ROOT_BRIDGE: Elected root bridge for instance 0.</p> <p>%SPANMGR-5-MSTP_NEW_ROOT_PORT: MSTP root changed to port Gi 11/38 for instance 0. My Bridge ID: 40960:0001.e801.fc35 Old Root: 40960:0001.e801.fc35 New Root: 32768:00d0.038a.2c01.</p> <p>%SPANMGR-5-MSTP_TOPOLOGY_CHANGE: Topology change BridgeAddr: 0001.e801.fc35 Mstp Instance Id 0 port Gi 11/38 transitioned from forwarding to discarding state.</p> |
| ecfm | <p>%ECFM-5-ECFM_XCON_ALARM: Cross connect fault detected by MEP 1 in Domain customer1 at Level 7 VLAN 1000</p> <p>%ECFM-5-ECFM_ERROR_ALARM: Error CCM Defect detected by MEP 1 in Domain customer1 at Level 7 VLAN 1000</p> <p>%ECFM-5-ECFM_MAC_STATUS_ALARM: MAC Status Defect detected by MEP 1 in Domain provider at Level 4 VLAN 3000</p> <p>%ECFM-5-ECFM_REMOTE_ALARM: Remote CCM Defect detected by MEP 3 in Domain customer1 at Level 7 VLAN 1000</p> <p>%ECFM-5-ECFM_RDI_ALARM: RDI Defect detected by MEP 3 in Domain customer1 at Level 7 VLAN 1000</p> |
| entity | <p>Enable entity change traps</p> <p>Trap SNMPv2-MIB::sysUpTime.0 = Timeticks: (1487406) 4:07:54.06, SNMPv2-MIB::snmpTrapOID.0 = OID: SNMPv2-SMI::mib-2.47.2.0.1, SNMPv2-SMI::enterprises.6027.3.6.1.1.2.0 = INTEGER: 4</p> <p>Trap SNMPv2-MIB::sysUpTime.0 = Timeticks: (1488564) 4:08:05.64, SNMPv2-MIB::snmpTrapOID.0 = OID: SNMPv2-SMI::mib-2.47.2.0.1, SNMPv2-SMI::enterprises.6027.3.6.1.1.2.0 = INTEGER: 5</p> <p>Trap SNMPv2-MIB::sysUpTime.0 = Timeticks: (1489064) 4:08:10.64, SNMPv2-MIB::snmpTrapOID.0 = OID: SNMPv2-SMI::mib-2.47.2.0.1, SNMPv2-SMI::enterprises.6027.3.6.1.1.2.0 = INTEGER: 6</p> |

Table 45-2. Dell Force10 Enterprise-specific SNMP Traps

| Command Option | Trap |
|----------------|--|
| | Trap SNMPv2-MIB::sysUpTime.0 = Timeticks: (1489568) 4:08:15.68, SNMPv2-MIB::snmpTrapOID.0 = OID: SNMPv2-SMI::mib-2.47.2.0.1, SNMPv2-SMI::enterprises.6027.3.6.1.1.2.0 = INTEGER: 7 |
| <cr> | SNMP Copy Config Command Completed |
| | %RPM0-P:CP %SNMP-4-RMON_RISING_THRESHOLD: RMON rising threshold alarm from SNMP OID <oid> |
| | %RPM0-P:CP %SNMP-4-RMON_FALLING_THRESHOLD: RMON falling threshold alarm from SNMP OID <oid> |
| | %RPM0-P:CP %SNMP-4-RMON_HC_RISING_THRESHOLD: RMON high-capacity rising threshold alarm from SNMP OID <oid> |

Copy Configuration Files Using SNMP

Use SNMP from a remote client to:

- copy the running-config file to the startup-config file, or
- copy configuration files from the Dell Force10 system to a server
- copy configuration files from a server to the Dell Force10 system

All of these tasks can be performed using IPv4 or IPv6 addresses. The examples in this section use IPv4 addresses; IPv6 addresses can be substituted for the IPv4 addresses in all of the examples.

The relevant MIBs for these functions are:

Table 45-3. MIB Objects for Copying Configuration Files via SNMP

| MIB Object | OID | Object Values | Description |
|---------------------|---------------------------------|--|---|
| copySrcFileType | .1.3.6.1.4.1.6027.3.5.1.1.1.1.2 | 1 = FTOS file 2 = running-config 3 = startup-config | Specifies the type of file to copy from. Range is: <ul style="list-style-type: none"> • If the copySrcFileType is running-config or startup-config, the default copySrcFileLocation is flash. • If the copySrcFileType is a binary file, the copySrcFileLocation and copySrcFileName must also be specified. |
| copySrcFileLocation | .1.3.6.1.4.1.6027.3.5.1.1.1.1.3 | 1 = flash 2 = slot0 3 = tftp 4 = ftp 5 = scp 6 = usbflash | Specifies the location of source file. <ul style="list-style-type: none"> • If the copySrcFileLocation is FTP or SCP, copyServerAddress, copyUserName, and copyUserPassword must be specified. |

Table 45-3. MIB Objects for Copying Configuration Files via SNMP

| MIB Object | OID | Object Values | Description |
|----------------------|----------------------------------|---|--|
| copySrcFileName | .1.3.6.1.4.1.6027.3.5.1.1.1.1.4 | Path (if file is not in current directory) and filename. | Specifies name of the file. <ul style="list-style-type: none"> If copySourceFileType is set to running-config or startup-config, copySrcFileName is not required. |
| copyDestFileType | .1.3.6.1.4.1.6027.3.5.1.1.1.1.5 | 1 = FTOS file 2 = running-config 3 = startup-config | Specifies the type of file to copy to. <ul style="list-style-type: none"> If the copySourceFileType is running-config or startup-config, the default copyDestFileLocation is flash. If the copyDestFileType is a binary the copyDestFileLocation and copyDestFileName must be specified. |
| copyDestFileLocation | .1.3.6.1.4.1.6027.3.5.1.1.1.1.6 | 1 = flash 2 = slot0 3 = tftp 4 = ftp 5 = scp | Specifies the location of destination file. <ul style="list-style-type: none"> If the copyDestFileLocation is FTP or SCP, copyServerAddress, copyUserName, and copyUserPassword must be specified. |
| copyDestFileName | .1.3.6.1.4.1.6027.3.5.1.1.1.1.7 | Path (if file is not in default directory) and filename. | Specifies the name of destination file. |
| copyServerAddress | .1.3.6.1.4.1.6027.3.5.1.1.1.1.8 | IP Address of the server | The IP address of the server. <ul style="list-style-type: none"> If the copyServerAddress is specified so must copyUserName, and copyUserPassword. |
| copyUserName | .1.3.6.1.4.1.6027.3.5.1.1.1.1.9 | Username for the server. | Username for the FTP, TFTP, or SCP server. <ul style="list-style-type: none"> If the copyUserName is specified so must copyUserPassword. |
| copyUserPassword | .1.3.6.1.4.1.6027.3.5.1.1.1.1.10 | Password for the server. | Password for the FTP, TFTP, or SCP server. |

To copy a configuration file:

| Step | Task | Command Syntax | Command Mode |
|------|---|---|---------------|
| 1 | Create an SNMP community string with read/write privileges. | snmp-server community <i>community-name</i> rw | CONFIGURATION |
| 2 | Copy the <i>f10-copy-config.mib</i> MIB from the Dell Force10 iSupport webpage to the server to which you are copying the configuration file. | | |

| Step | Task | Command Syntax | Command Mode |
|------|--|----------------|--------------|
| 3 | On the server, use the command snmpset as shown: | | |
| | <p>snmpset -v snmp-version -c community-name -m mib_path/f10-copy-config.mib force10system-ip-address mib-object.index {i a s} object-value...</p> <ul style="list-style-type: none"> • Every specified object must have an object value, which must be preceded by the keyword i. See Table 6 for ranges. • <i>index</i> must be unique to all previously executed snmpset commands. If an index value has been used previously, a message like the one in Message 3 appears. In this case, increment the index value and enter the command again. • Use as many MIB Objects in the command as required by the MIB Object descriptions in Table 6 to complete the command. See Table 7 or examples. <p> Note: You can use the entire OID rather than the object name. Use the form: <i>OID.index i object-value</i>, as shown in Figure 57.</p> | | |

Message 2 snmpset Index Value Error

```
Error in packet.
Reason: notWritable (that object does not support modification)
Failed object: FTOS-COPY-CONFIG-MIB::copySrcFileType.101
```

[Table 7](#) shows examples of using the command **snmpset** to copy a configuration. These examples assume that:

- the server OS is UNIX
- you are using SNMP version 2c
- the community name is public, and
- the file *f10-copy-config.mib* is in the current directory or in the **snmpset** tool path.

 **Note:** In UNIX, enter the command **snmpset** for help using this command. Place the file *f10-copy-config.mib* in the directory from which you are executing the **snmpset** command or in the **snmpset** tool path.

 **Note:** Use the following options in the **snmpset** command to view additional information:

- c: View the community, either public or private
- m: View the MIB files for the SNMP command
- r: Number of retries using the option
- t: View the timeout
- v: View the SNMP version (either 1, 2, 2d or 3)

Table 45-4. Copying Configuration Files via SNMP

| Task |
|--|
| Copy the running-config to the startup-config using the following command from the UNIX machine: |

Table 45-4. Copying Configuration Files via SNMP**Task**

```
snmpset -v 2c -c public force10system-ip-address copySrcFileType.index i 2 copyDestFileType.index i 3
```

Figure 45-7 show the command syntax using MIB object names. Figure 45-8 shows the same command using the object OIDs. In both cases, the object is followed by a unique index number.

Figure 45-7. Copying Configuration Files via SNMP using Object-Name Syntax

```
> snmpset -v 2c -r 0 -t 60 -c private -m ./f10-copy-config.mib 10.10.10.10 copySrcFileType.101
i 2 copyDestFileType.101 i 3
FTOS-COPY-CONFIG-MIB::copySrcFileType.101 = INTEGER: runningConfig(2)
FTOS-COPY-CONFIG-MIB::copyDestFileType.101 = INTEGER: startupConfig(3)
```

Figure 45-8. Copying Configuration Files via SNMP using OID Syntax

```
> snmpset -v 2c -c public -m ./f10-copy-config.mib 10.10.10.10
.1.3.6.1.4.1.6027.3.5.1.1.1.1.2.100 i 2 .1.3.6.1.4.1.6027.3.5.1.1.1.1.5.100 i 3
FFTOS-COPY-CONFIG-MIB::copySrcFileType.100 = INTEGER: runningConfig(2)
FTOS-COPY-CONFIG-MIB::copyDestFileType.100 = INTEGER: startupConfig(3)
```

Copy the startup-config to the running-config using the following command from a UNIX machine:

```
snmpset -c private -v 2c force10system-ip-address copySrcFileType.index i 3 copyDestFileType.index i 2
```

Figure 45-9. Copying Configuration Files via SNMP using Object-Name Syntax

```
> snmpset -c public -v 2c -m ./f10-copy-config.mib 10.11.131.162 copySrcFileType.7 i 3
copyDestFileType.7 i 2
FTOS-COPY-CONFIG-MIB::copySrcFileType.7 = INTEGER: runningConfig(3)
FTOS-COPY-CONFIG-MIB::copyDestFileType.7 = INTEGER: startupConfig(2)
```

Figure 45-10. Copying Configuration Files via SNMP using OID Syntax

```
>snmpset -c public -v 2c 10.11.131.162 .1.3.6.1.4.1.6027.3.5.1.1.1.1.2.8 i 3
.1.3.6.1.4.1.6027.3.5.1.1.1.1.5.8 i 2
SNMPv2-SMI::enterprises.6027.3.5.1.1.1.1.2.8 = INTEGER: 3
SNMPv2-SMI::enterprises.6027.3.5.1.1.1.1.5.8 = INTEGER: 2
```

Copy the startup-config to the server via FTP using the following command from the UNIX machine:

```
snmpset -v 2c -c public -m ./f10-copy-config.mib force10system-ip-address copySrcFileType.index i 2
copyDestFileName.index s filepath/filename copyDestFileLocation.index i 4 copyServerAddress.index a
server-ip-address copyUserName.index s server-login-id copyUserPassword.index s server-login-password
```

Table 45-4. Copying Configuration Files via SNMP

Task

- *server-ip-address* must be preceded by the keyword **a**.
- values for *copyUsername* and *copyUserPassword* must be preceded by the keyword **s**.

Figure 45-11. Copying Configuration Files via SNMP and FTP to a Remote Server

```
> snmpset -v 2c -c private -m ./f10-copy-config.mib 10.10.10.10 copySrcFileType.110 i 2
copyDestFileName.110 s /home/startup-config copyDestFileLocation.110 i 4 copyServerAddress.110
a 11.11.11.11 copyUserName.110 s mylogin copyUserPassword.110 s mypass
FTOS-COPY-CONFIG-MIB::copySrcFileType.110 = INTEGER: runningConfig(2)
FTOS-COPY-CONFIG-MIB::copyDestFileName.110 = STRING: /home/startup-config
FTOS-COPY-CONFIG-MIB::copyDestFileLocation.110 = INTEGER: ftp(4)
FTOS-COPY-CONFIG-MIB::copyServerAddress.110 = IpAddress: 11.11.11.11
FTOS-COPY-CONFIG-MIB::copyUserName.110 = STRING: mylogin
FTOS-COPY-CONFIG-MIB::copyUserPassword.110 = STRING: mypass
```

Copy the startup-config to the server via TFTP using the following command from the UNIX machine:

Note: Verify that the file exists and its permissions are set to 777. Specify the relative path to the TFTP root directory.

```
snmpset -v 2c -c public -m ./f10-copy-config.mib force10system-ip-address copySrcFileType.index i 3
copyDestFileType.index i 1 copyDestFileName.index s filepath/filename copyDestFileLocation.index i 3
copyServerAddress.index a server-ip-address
```

Figure 45-12. Copying Configuration Files via SNMP and TFTP to a Remote Server

```
.snmpset -v 2c -c private -m ./f10-copy-config.mib 10.10.10.10
copySrcFileType.4 i 3
copyDestFileType.4 i 1
copyDestFileLocation.4 i 3
copyDestFileName.4 s /home/myfilename
copyServerAddress.4 a 11.11.11.11
```

Copy a binary file from the server to the startup-configuration on the Dell Force10 system via FTP using the following command:

```
snmpset -v 2c -c public -m ./f10-copy-config.mib force10system-ip-address copySrcFileType.index i 1
copySrcFileLocation.index i 4 copySrcFileName.index s filepath/filename copyDestFileType.index i 3
copyServerAddress.index a server-ip-address copyUserName.index s server-login-id copyUserPassword.index s
server-login-password
```

Figure 45-13. Copying Configuration Files via SNMP and FTP from a Remote Server

```
> snmpset -v 2c -c private -m ./f10-copy-config.mib 10.10.10.10 copySrcFileType.10 i 1
copySrcFileLocation.10 i 4 copyDestFileType.10 i 3 copySrcFileName.10 s /home/myfilename
copyServerAddress.10 a 172.16.1.56 copyUserName.10 s mylogin copyUserPassword.10 s mypass
```

Dell Force10 provides additional MIB Objects to view copy statistics. These are provided in [Table 45-5](#).

Table 45-5. MIB Objects for Copying Configuration Files via SNMP

| MIB Object | OID | Values | Description |
|--------------------|----------------------------------|---|--|
| copyState | .1.3.6.1.4.1.6027.3.5.1.1.1.1.11 | 1 = running 2 = successful 3 = failed | Specifies the state of the copy operation. |
| copyTimeStarted | .1.3.6.1.4.1.6027.3.5.1.1.1.1.12 | Time value | Specifies the point in the up-time clock that the copy operation started. |
| copyTimeCompleted | .1.3.6.1.4.1.6027.3.5.1.1.1.1.13 | Time value | Specifies the point in the up-time clock that the copy operation completed. |
| copyFailCause | .1.3.6.1.4.1.6027.3.5.1.1.1.1.14 | 1 = bad file name 2 = copy in progress 3 = disk full 4 = file exists 5 = file not found 6 = timeout 7 = unknown | Specifies the reason the copy request failed. |
| copyEntryRowStatus | .1.3.6.1.4.1.6027.3.5.1.1.1.1.15 | Row status | Specifies the state of the copy operation. Uses CreateAndGo when you are performing the copy. The state is set to active when the copy is completed. |

To obtain a value for any of the MIB Objects in [Table 45-5](#):

| Step | Task |
|------|---|
| 1 | <p>Get a copy-config MIB object value.</p> <pre>snmpset -v 2c -c public -m ./f10-copy-config.mib force10system-ip-address [OID.index mib-object.index]</pre> <ul style="list-style-type: none"> <i>index</i> is the index value used in the snmpset command used to complete the copy operation. <p> Note: You can use the entire OID rather than the object name. Use the form: OID.index, as shown in Figure 45-15.</p> |

[Figure 45-14](#) and [Figure 45-15](#) are examples of using the command **snmpget** to obtain a MIB object value. These examples assume that:

- the server OS is UNIX
- you are using SNMP version 2c
- the community name is public, and
- the file *f10-copy-config.mib* is in the current directory.

 **Note:** In UNIX, enter the command **snmpset** for help using this command.

Figure 45-14 shows the command syntax using MIB object names, and Figure 45-15 shows the same command using the object OIDs. In both cases, the object is followed by same index number used in the `snmpset` command.

Figure 45-14. Obtaining MIB Object Values for a Copy Operation using Object-name Syntax

```
> snmpget -v 2c -c private -m ./f10-copy-config.mib 10.11.131.140 copyTimeCompleted.110
FTOS-COPY-CONFIG-MIB::copyTimeCompleted.110 = Timeticks: (1179831) 3:16:38.31
```

Figure 45-15. Obtaining MIB Object Values for a Copy Operation using OID Syntax

```
> snmpget -v 2c -c private 10.11.131.140 .1.3.6.1.4.1.6027.3.5.1.1.1.13.110
SNMPv2-SMI::enterprises.6027.3.5.1.1.1.13.110 = Timeticks: (1179831) 3:16:38.31
```

Manage VLANs using SNMP

The `qBridgeMIB` managed objects in the `Q-BRIDGE-MIB`, defined in RFC 2674, enable you to use SNMP manage VLANs.

Create a VLAN

Use the `dot1qVlanStaticRowStatus` object to create a VLAN. The `snmpset` operation in Figure 45-16 creates VLAN 10 by specifying a value of 4 for instance 10 of the `dot1qVlanStaticRowStatus` object.

Figure 45-16. Creating a VLAN using SNMP

```
> snmpset -v2c -c mycommunity 123.45.6.78 .1.3.6.1.2.1.17.7.1.4.3.1.5.10 i 4
SNMPv2-SMI::mib-2.17.7.1.4.3.1.5.10 = INTEGER: 4
```

Assign a VLAN Alias

Write a character string to the `dot1qVlanStaticName` object to assign a name to a VLAN, as shown in Figure 45-17.

Figure 45-17. Assign a VLAN Alias using SNMP

```
[Unix system output]

> snmpset -v2c -c mycommunity 10.11.131.185 .1.3.6.1.2.1.17.7.1.4.3.1.1.1107787786 s "My
VLAN"
SNMPv2-SMI::mib-2.17.7.1.4.3.1.1.1107787786 = STRING: "My VLAN"

[FTOS system output]

FTOS#show int vlan 10
Vlan 10 is down, line protocol is down
Vlan alias name is: My VLAN
Address is 00:01:e8:cc:cc:ce, Current address is 00:01:e8:cc:cc:ce
Interface index is 1107787786
Internet address is not set
MTU 1554 bytes, IP MTU 1500 bytes
LineSpeed auto
```

Display the Ports in a VLAN

FTOS identifies VLAN interfaces using an interface index number that is displayed in the output of the command **show interface vlan**, as shown in [Figure 45-18](#).

Figure 45-18. Identifying the VLAN Interface Index Number

```
FTOS(conf)#do show interface vlan id 10
% Error: No such interface name.
R5(conf)#do show interface vlan 10
Vlan 10 is down, line protocol is down
Address is 00:01:e8:cc:cc:ce, Current address is 00:01:e8:cc:cc:ce
Interface index is 1107787786
Internet address is not set
MTU 1554 bytes, IP MTU 1500 bytes
LineSpeed auto
ARP type: ARPA, ARP Timeout 04:00:00
```

To display the ports in a VLAN, send an **snmpget** request for the object **dot1qStaticEgressPorts** using the interface index as the instance number, as shown for an S-Series in [Figure 45-19](#).

Figure 45-19. Display the Ports in a VLAN in SNMP

```
> snmpget -v2c -c mycommunity 10.11.131.185 .1.3.6.1.2.1.17.7.1.4.3.1.2.1107787786
SNMPv2-SMI::mib-2.17.7.1.4.3.1.2.1107787786 = Hex-STRING:
00 00 00 00 00 00 00 00 00 00 00 00 00 00 00 00
00 00 00 00 00 00 00 00 00 00 00 00 00 00 00 00
00 00 00 00 00 00 00 00 00 00 00 00 00 00 00 00
```

The table that the Dell Force10 system sends in response to the snmpget request is a table that contains hexadecimal (hex) pairs, each pair representing a group of eight ports.

- On the E-Series, 12 hex pairs represents a line card. Twelve pairs accommodates the greatest currently available line card port density, 96 ports.
- On the C-Series, 28 hex pairs represents a line card. Twenty-eight pairs accommodates the greatest currently available line card port density, 28 ports per port-pipe, and any remaining hex pairs are unused.
- On the S-Series, 7 hex pairs represents a stack unit. Seven pairs accommodates the greatest number of ports available on an S-Series – 56 ports on the S55 and S60; 64 ports on the S4810 and S4820T. On the S55 and S60, the last stack unit is assigned 8 pairs; the eighth pair is unused. On the S4810 and S4820T, the last stack unit begins on the 66th bit.

The first hex pair, 00 in [Figure 45-19](#), represents ports 1-7 in Stack Unit 0. The next pair to the right represents ports 8-15. To resolve the hex pair into a representation of the individual ports, convert the hex pair to binary. Consider the first hex pair 00, which resolves to 0000 0000 in binary:

- On the E-Series and C-Series each position in the 8-character string is for one port, starting with Port 0 at the left end of the string, and ending with Port 7 at the right end. A 0 indicates that the port is not a member of the VLAN; a 1 indicates VLAN membership.
- On the S-Series, each position in the 8-character string is for one port, starting with Port 1 at the left end of the string, and ending with Port 8 at the right end. A 0 indicates that the port is not a member of the VLAN; a 1 indicates VLAN membership.

[Figure 45-19](#) shows the output for an S-Series. All hex pairs are 00, indicating that no ports are assigned to VLAN 10. In [Figure 45-20](#), Port 0/2 is added to VLAN 10 as untagged. And the first hex pair changes from 00 to 04.

Figure 45-20. Displaying Ports in a VLAN using SNMP

[FTOS system output]

```
R5(conf)#do show vlan id 10
```

Codes: * - Default VLAN, G - GVRP VLANs

Q: U - Untagged, T - Tagged

x - Dot1x untagged, X - Dot1x tagged

G - GVRP tagged, M - Vlan-stack

| NUM | Status | Description | Q Ports |
|-----|----------|-------------|----------|
| 10 | Inactive | | U Gi 0/2 |

[Unix system output]

```
> snmpget -v2c -c mycommunity 10.11.131.185 .1.3.6.1.2.1.17.7.1.4.3.1.2.1107787786
```

```
SNMPv2-SMI::mib-2.17.7.1.4.3.1.2.1107787786 = Hex-STRING: 40 00 00 00 00 00 00 00 00 00 00
```

The value 40 is in the first set of 7 hex pairs, indicating that these ports are in Stack Unit 0. The hex value 40 is 0100 0000 in binary. As described above, the left-most position in the string represents Port 1. The next position from the left represents Port 2 and has a value of 1, indicating that Port 0/2 is in VLAN 10. The remaining positions are 0, so those ports are not in the VLAN.

Note that the table contains none of the other information provided by the command, such as port speed or whether the ports are tagged or untagged.

Add Tagged and Untagged Ports to a VLAN

The value dot1qVlanStaticEgressPorts object is an array of all VLAN members.

The dot1qVlanStaticUntaggedPorts object is an array of only untagged VLAN members. All VLAN members that are not in dot1qVlanStaticUntaggedPorts are tagged.

- To add a tagged port to a VLAN, write the port to the dot1qVlanStaticEgressPorts object, as shown in [Figure 45-21](#).
- To add an untagged port to a VLAN, write the port to the dot1qVlanStaticEgressPorts and dot1qVlanStaticUntaggedPorts objects, as shown in [Figure 45-22](#).



Note: Whether adding a tagged or untagged port, you must specify values for both dot1qVlanStaticEgressPorts and dot1qVlanStaticUntaggedPorts.

In [Figure 45-21](#), Port 0/2 is added as an untagged member of VLAN 10.

Figure 45-21. Adding Untagged Ports to a VLAN using SNMP

```
>snmpset -v2c -c mycommunity 10.11.131.185 .1.3.6.1.2.1.17.7.1.4.3.1.2.1107787786 x "40 00
00 00 00 00 00 00 00 00 00 00 00 00 00 00 00 00 00 00 00 00 00 00 00 00 00 00 00 00 00
00 00 00 00 00 00 00 00 00 00 00 00 00 00 00 00 00 00 00 00 00 00 00 00 00 00 00 00 00
.1.3.6.1.2.1.17.7.1.4.3.1.4.1107787786 x "40 00 00 00 00 00 00 00 00 00 00 00 00 00 00 00 00
00 00 00 00 00 00 00 00 00 00 00 00 00 00 00 00 00 00 00 00 00 00 00 00 00 00 00 00 00
00 00 00 00 00 00 00 00 00 00 00 00 00 00 00 00 00 00 00 00 00 00 00 00 00 00 00 00 00

SNMPv2-SMI::mib-2.17.7.1.4.3.1.2.1107787786 = Hex-STRING: 40 00 00 00 00 00 00 00 00 00 00
00 00 00 00 00
00 00 00 00 00 00 00 00 00 00 00 00 00 00 00 00
00 00 00 00 00 00 00 00 00 00 00 00 00 00 00 00
00 00 00 00 00 00 00 00 00

SNMPv2-SMI::mib-2.17.7.1.4.3.1.4.1107787786 = Hex-STRING: 40 00 00 00 00 00 00 00 00 00 00
00 00 00 00 00
00 00 00 00 00 00 00 00 00 00 00 00 00 00 00 00
00 00 00 00 00 00 00 00 00 00 00 00 00 00 00 00
00 00 00 00 00 00 00 00 00
```

In Figure 45-22, Port 0/2 is added as a tagged member of VLAN 10.

Figure 45-22. Adding Tagged Ports to a VLAN using SNMP

```
>snmpset -v2c -c mycommunity 10.11.131.185 .1.3.6.1.2.1.17.7.1.4.3.1.2.1107787786 x "40 00
00 00 00 00 00 00 00 00 00 00 00 00 00 00 00 00 00 00 00 00 00 00 00 00 00 00 00 00
00 00 00 00 00 00 00 00 00 00 00 00 00 00 00 00 00 00 00 00 00 00 00 00 00 00 00
.1.3.6.1.2.1.17.7.1.4.3.1.4.1107787786 x "00 00 00 00 00 00 00 00 00 00 00 00 00 00 00
00 00 00 00 00 00 00 00 00 00 00 00 00 00 00 00 00 00 00 00 00 00 00 00 00 00 00
00 00 00 00 00 00 00 00 00"

SNMPv2-SMI::mib-2.17.7.1.4.3.1.2.1107787786 = Hex-STRING: 40 00 00 00 00 00 00 00 00 00
00 00 00 00

00 00 00 00 00 00 00 00 00 00 00 00 00 00 00 00

00 00 00 00 00 00 00 00 00 00 00 00 00 00 00 00

00 00 00 00 00 00 00 00 00

SNMPv2-SMI::mib-2.17.7.1.4.3.1.4.1107787786 = Hex-STRING: 00 00 00 00 00 00 00 00 00 00
00 00 00 00

00 00 00 00 00 00 00 00 00 00 00 00 00 00 00 00

00 00 00 00 00 00 00 00 00 00 00 00 00 00 00
```

Managing Overload on Startup

If you are running IS-IS, you can set a specific amount of time to prevent ingress traffic from being received after a reload and allow the routing protocol upgrade process to complete.

Use the following command to prevent ingress traffic on a router while the IS reload is implemented:

| Task | Command |
|---|---|
| Set the amount of time after an IS-IS reload is performed before ingress traffic is allowed at startup. | set-overload-bit on-startup isis |

The following OIDs are configurable through the snmpset command.

The node OID is 1.3.6.1.4.1.6027.3.18

```
F10-ISIS-MIB::f10IsisSysOloadSetOverload
F10-ISIS-MIB::f10IsisSysOloadSetOloadOnStartupUntil
F10-ISIS-MIB::f10IsisSysOloadWaitForBgp
F10-ISIS-MIB::f10IsisSysOloadV6SetOverload
F10-ISIS-MIB::f10IsisSysOloadV6SetOloadOnStartupUntil
F10-ISIS-MIB::f10IsisSysOloadV6WaitForBgp
```

To enable overload bit for IPv4 set 1.3.6.1.4.1.6027.3.18.1.1 and IPv6 set 1.3.6.1.4.1.6027.3.18.1.4

To set time to wait set 1.3.6.1.4.1.6027.3.18.1.2 and 1.3.6.1.4.1.6027.3.18.1.5 respectively

To set time to wait till bgp session are up set 1.3.6.1.4.1.6027.3.18.1.3 and 1.3.6.1.4.1.6027.3.18.1.6

Enable and Disable a Port using SNMP

| Step | Task | Command Syntax | Command Mode |
|------|---|------------------------------|----------------|
| 1 | Create an SNMP community on the Dell Force10 system. | snmp-server community | CONFIGURATION |
| 2 | From the Dell Force10 system, identify the interface index of the port for which you want to change the admin status. Or, from the management system, use the snmpwalk command to identify the interface index. | show interface | EXEC Privilege |
| 3 | Enter the command snmpset to change the admin status using either the object descriptor or the OID. Choose integer 1 to change the admin status to Up, or 2 to change the admin status to Down. snmpset with descriptor: snmpset -v version -c community agent-ip ifAdminStatus .ifindex i {1 2} snmpset with OID: snmpset -v version -c community agent-ip .1.3.6.1.2.1.2.2.1.7.ifindex i {1 2} | | |

Fetch Dynamic MAC Entries using SNMP

Dell Force10 supports the RFC 1493 dot1d table for the default VLAN and the dot1q table for all other VLANs.



Note: The 802.1q Q-BRIDGE MIB defines VLANs with regard to 802.1d, as 802.1d itself does not define them. As a switchport must belong a VLAN (the default VLAN or a configured VLAN), all MAC address learned on a switchport are associated with a VLAN. For this reason, the Q-Bridge MIB is used for MAC address query. Moreover, specific to MAC address query, dot1dTpFdbTable is indexed by MAC address only for a single forwarding database, while dot1qTpFdbTable has two indices —VLAN ID and MAC address—to allow for multiple forwarding databases and considering that the same MAC address is learned on multiple VLANs. The VLAN ID is added as the first index so that MAC addresses can be read by VLAN, sorted lexicographically. The MAC address is are part of the OID instance, so in this case, lexicographic order is according to the most significant octet.

Table 45-6. MIB Objects for Fetching Dynamic MAC Entries in the Forwarding Database

| MIB Object | OID | Description | MIB |
|----------------------|---------------------------------|--|---------------------------|
| dot1dTpFdbTable | .1.3.6.1.2.1.17.4.3 | List the learned unicast MAC addresses on the default VLAN. | Q-BRIDGE MIB |
| dot1qTpFdbTable | .1.3.6.1.2.1.17.7.1.2. 2 | List the learned unicast MAC addresses on non-default VLANs. | |
| dot3aCurAggFdb Table | .1.3.6.1.4.1.6027.3.2. 1.1.5 | List the learned MAC addresses of aggregated links (LAG). | F10-LINK-AGGREGATION -MIB |

In [Figure 45-23](#), R1 has one dynamic MAC address, learned off of port GigabitEthernet 1/21, which a member of the default VLAN, VLAN 1. The SNMP walk returns the values for dot1dTpFdbAddress, dot1dTpFdbPort, and dot1dTpFdbStatus.

Each object is comprised an OID concatenated with an instance number. In the case of these objects, the instance number is the decimal equivalent of the MAC address; derive the instance number by converting each hex pair to its decimal equivalent. For example, the decimal equivalent of E8 is 232, and so the instance number for MAC address 00:01:e8:06:95:ac is.0.1.232.6.149.172.

The value of dot1dTpFdbPort is the port number of the port off which the system learns the MAC address. In this case, of GigabitEthernet 1/21, the manager returns the integer 118. The maximum line card port density on the E-Series is 96 ports, and line card numbering begins with 0; GigabitEthernet 1/21 is the 21st port on Line Card 1, and 96 + 21 yields 118.

Figure 45-23. Fetching Dynamic MAC Addresses on the Default VLAN

```

-----MAC Addresses on Force10 System-----
R1_E600#show mac-address-table
VlanId      Mac Address      Type   Interface      State
  1          00:01:e8:06:95:ac   Dynamic Gi 1/21      Active
-----Query from Management Station-----
>snmpwalk -v 2c -c techpubs 10.11.131.162 .1.3.6.1.2.1.17.4.3.1
SNMPv2-SMI::mib-2.17.4.3.1.1.0.1.232.6.149.172 = Hex-STRING: 00 01 E8 06 95 AC

```

In [Figure 45-24](#), GigabitEthernet 1/21 is moved to VLAN 1000, a non-default VLAN. Use the objects dot1qTpFdbTable to fetch the MAC addresses learned on non-default VLANs. The instance number is the VLAN number concatenated with the decimal conversion of the MAC address.

Figure 45-24. Fetching Dynamic MAC Addresses on Non-default VLANs

```

-----MAC Addresses on Force10 System-----
R1_E600#show mac-address-table
VlanId      Mac Address      Type   Interface      State
 1000        00:01:e8:06:95:ac   Dynamic Gi 1/21      Active
-----Query from Management Station-----
>snmpwalk -v 2c -c techpubs 10.11.131.162 .1.3.6.1.2.1.17.7.1.2.2.1

```

Use dot3aCurAggFdbTable to fetch the learned MAC address of a port-channel. The instance number is the decimal conversion of the MAC address concatenated with the port-channel number.

Figure 45-25. Fetching Dynamic MAC Addresses on the Default VLAN

```

-----MAC Addresses on Force10 System-----
R1_E600(conf)#do show mac-address-table
VlanId      Mac Address      Type   Interface      State
 1000        00:01:e8:06:95:ac   Dynamic Po 1         Active
-----Query from Management Station-----
>snmpwalk -v 2c -c techpubs 10.11.131.162 .1.3.6.1.4.1.6027.3.2.1.1.5
SNMPv2-SMI::enterprises.6027.3.2.1.1.5.1.1.1000.0.1.232.6.149.172.1 = INTEGER: 1000
SNMPv2-SMI::enterprises.6027.3.2.1.1.5.1.2.1000.0.1.232.6.149.172.1 = Hex-STRING: 00 01 E8
06 95 AC
SNMPv2-SMI::enterprises.6027.3.2.1.1.5.1.3.1000.0.1.232.6.149.172.1 = INTEGER: 1
SNMPv2-SMI::enterprises.6027.3.2.1.1.5.1.4.1000.0.1.232.6.149.172.1 = INTEGER: 1

```

Deriving Interface Indices

FTOS assigns an interface number to each (configured or unconfigured) physical and logical interface. Display the interface index number using the command **show interface** from EXEC Privilege mode, as shown in [Figure 45-26](#).

Figure 45-26. Display the Interface Index Number

```
FTOS#show interface gig 1/21
GigabitEthernet 1/21 is up, line protocol is up
Hardware is Force10Eth, address is 00:01:e8:0d:b7:4e
  Current address is 00:01:e8:0d:b7:4e
Interface index is 72925242
[output omitted]
```

The interface index is a binary number with bits that indicate the slot number, port number, interface type, and card type of the interface. FTOS converts this binary index number to decimal, and displays it in the output of the **show interface** command.

Figure 45-27. Interface Index Binary Calculations

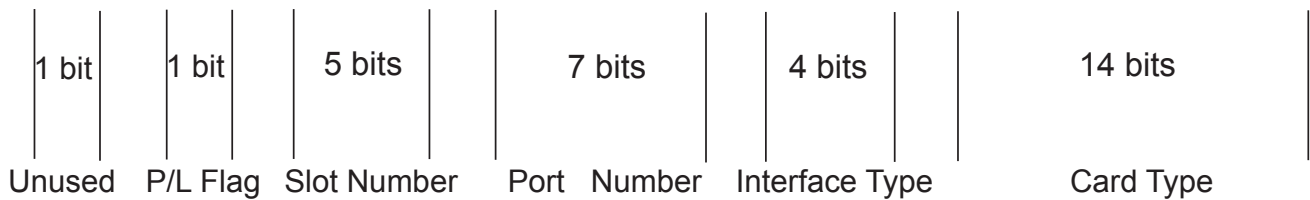

Starting from the least significant bit (LSB):

- the first 14 bits represent the card type
- the next 4 bits represent the interface type
- the next 7 bits represent the port number
- the next 5 bits represent the slot number
- the next 1 bit is 0 for a physical interface and 1 for a logical interface
- the next 1 bit is unused

For example, the index 72925242 is 100010110001100000000111010 in binary. The binary interface index for GigabitEthernet 1/21 of a 48-port 10/100/1000Base-T line card with RJ-45 interface is shown in [Figure 45-28](#). Notice that the physical/logical bit and the final, unused bit are not given. The interface is physical, so this must be represented by a 0 bit, and the unused bit is always 0. These two bits are not given because they are the most significant bits, and leading zeros are often omitted.

Figure 45-28. Binary Representation of Interface Index

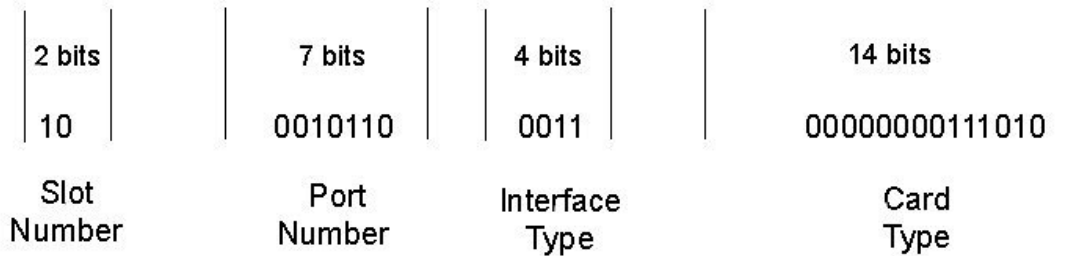

For interface indexing, slot and port numbering begins with the binary one. If the Dell Force10 system begins slot and port numbering from 0, then the binary 1 represents slot and port 0. For example, the index number in [Figure 45-28](#) gives the binary 2 for the slot number, though interface GigabitEthernet 1/21 belongs to Slot 1. This is because the port for this example is on an E-Series which begins numbering slots from 0. You must subtract 1 from the slot number 2, which yields 1, the correct slot number for interface 1/21.

Note that the interface index does not change if the interface reloads or fails over. On the S-Series, if the unit is renumbered (for any reason) the interface index will change during a reload.

Monitor Port-channels

To check the status of a Layer 2 port-channel, use `fl0LinkAggMib (.1.3.6.1.4.1.6027.3.2)`. Below, Po 1 is a switchport and Po 2 is in Layer 3 mode.

```
[senthilnathan@lithium ~]$ snmpwalk -v 2c -c public 10.11.1.1 .1.3.6.1.4.1.6027.3.2.1.1
SNMPv2-SMI::enterprises.6027.3.2.1.1.1.1.1 = INTEGER: 1
SNMPv2-SMI::enterprises.6027.3.2.1.1.1.1.2 = INTEGER: 2
SNMPv2-SMI::enterprises.6027.3.2.1.1.1.1.2.1 = Hex-STRING: 00 01 E8 13 A5 C7
SNMPv2-SMI::enterprises.6027.3.2.1.1.1.1.2.2 = Hex-STRING: 00 01 E8 13 A5 C8
SNMPv2-SMI::enterprises.6027.3.2.1.1.1.1.3.1 = INTEGER: 1107755009
SNMPv2-SMI::enterprises.6027.3.2.1.1.1.1.3.2 = INTEGER: 1107755010
SNMPv2-SMI::enterprises.6027.3.2.1.1.1.1.4.1 = INTEGER: 1
SNMPv2-SMI::enterprises.6027.3.2.1.1.1.1.4.2 = INTEGER: 1
SNMPv2-SMI::enterprises.6027.3.2.1.1.1.1.5.1 = Hex-STRING: 00 00
SNMPv2-SMI::enterprises.6027.3.2.1.1.1.1.5.2 = Hex-STRING: 00 00
SNMPv2-SMI::enterprises.6027.3.2.1.1.1.1.6.1 = STRING: "Gi 5/84 " << Channel member for Po1
SNMPv2-SMI::enterprises.6027.3.2.1.1.1.1.6.2 = STRING: "Gi 5/85 " << Channel member for Po2
dot3aCommonAggFdbIndex
SNMPv2-SMI::enterprises.6027.3.2.1.1.6.1.1.1107755009.1 = INTEGER: 1107755009
dot3aCommonAggFdbVlanId
SNMPv2-SMI::enterprises.6027.3.2.1.1.6.1.2.1107755009.1 = INTEGER: 1
dot3aCommonAggFdbTagConfig
SNMPv2-SMI::enterprises.6027.3.2.1.1.6.1.3.1107755009.1 = INTEGER: 2 (Tagged 1 or Untagged 2)
dot3aCommonAggFdbStatus
```

```
SNMPv2-SMI::enterprises.6027.3.2.1.1.6.1.4.1107755009.1 = INTEGER: 1 << Status active, 2 - status inactive
```

If we learn MAC addresses for the LAG, status will be shown for those as well.

```
dot3aCurAggVlanId
SNMPv2-SMI::enterprises.6027.3.2.1.1.4.1.1.1.0.0.0.0.0.1.1 = INTEGER: 1
dot3aCurAggMacAddr
SNMPv2-SMI::enterprises.6027.3.2.1.1.4.1.2.1.0.0.0.0.0.1.1 = Hex-STRING: 00 00 00 00 00 01
dot3aCurAggIndex
SNMPv2-SMI::enterprises.6027.3.2.1.1.4.1.3.1.0.0.0.0.0.1.1 = INTEGER: 1
dot3aCurAggStatus
SNMPv2-SMI::enterprises.6027.3.2.1.1.4.1.4.1.0.0.0.0.0.1.1 = INTEGER: 1 << Status active, 2 - status inactive
```

Layer 3 LAG does not include this support.

SNMP trap works fine for the Layer 2 / Layer 3 / default mode LAG

```
SNMPv2-MIB::sysUpTime.0 = Timeticks: (8500842) 23:36:48.42
SNMPv2-MIB::snmpTrapOID.0 = OID: IF-MIB::linkDown
IF-MIB::ifIndex.33865785 = INTEGER: 33865785
SNMPv2-SMI::enterprises.6027.3.1.1.4.1.2 = STRING: "OSTATE_DN: Changed interface state to down: Gi 0/0"
2010-02-10 14:22:39 10.16.130.4 [10.16.130.4]:
SNMPv2-MIB::sysUpTime.0 = Timeticks: (8500842) 23:36:48.42
SNMPv2-MIB::snmpTrapOID.0 = OID: IF-MIB::linkDown
IF-MIB::ifIndex.1107755009 = INTEGER: 1107755009
SNMPv2-SMI::enterprises.6027.3.1.1.4.1.2 = STRING: "OSTATE_DN: Changed interface state to down: Po 1"
2010-02-10 14:22:40 10.16.130.4 [10.16.130.4]:
SNMPv2-MIB::sysUpTime.0 = Timeticks: (8500932) 23:36:49.32          SNMPv2-MIB::snmpTrapOID.0 = OID:
IF-MIB::linkUp IF-MIB::ifIndex.33865785 = INTEGER: 33865785      SNMPv2-SMI::enterprises.6027.3.1.1.4.1.2 =
STRING: "OSTATE_UP: Changed interface state to up: Gi 0/0"
2010-02-10 14:22:40 10.16.130.4 [10.16.130.4]:
SNMPv2-MIB::sysUpTime.0 = Timeticks: (8500934) 23:36:49.34          SNMPv2-MIB::snmpTrapOID.0 = OID:
IF-MIB::linkUp IF-MIB::ifIndex.1107755009 = INTEGER: 1107755009
SNMPv2-SMI::enterprises.6027.3.1.1.4.1.2 = STRING: "OSTATE_UP: Changed interface state to up: Po 1"
```

Troubleshooting SNMP Operation

When you use SNMP to retrieve management data from an SNMP agent on a Dell Force10 router, take into account the following behavior:

- When you query an IPv4 icmpMsgStatsInPkts object in the ICMP table by using the **snmpwalk** command, the output for echo replies may be incorrectly displayed. Use the **show ip traffic** command to correctly display this information under ICMP statistics.
- When you query an icmpStatsInErrors object in the icmpStats table by using the **snmpget** or **snmpwalk** command, the output for IPv4 addresses may be incorrectly displayed. Use the **show ip traffic** command to correctly display this information under IP and ICMP statistics.
- When you query an IPv4 icmpMsgStatsInPkts object in the ICMP table by using the **snmpwalk** command, the echo response output may not be displayed. Use the **show ip traffic** command to correctly display ICMP statistics, such as echo response.

Stacking

Stacking is supported on the following platforms: S S-Series (S50/S25), **S55** **S60** **S4810** **S4820T**

Stacking is supported on the S4810 with FTOS version 8.3.7.1, version 8.3.10.2 and newer. Stacking is supported on the S4820T with FTOS 8.3.19.0.

 **Note:** The S4810 commands accept Unit ID numbers 0-11, though the S4810 supports stacking up to 3 units only with FTOS version 8.3.7.1 and version 8.3.10.2. The S4810 supports stacking up to 6 units on FTOS version 8.3.12.0.

 **Note:** The S4820T supports stacking up to 6 units on FTOS version 8.3.19.0.

Switch Stacking and DCB Caveats for the S4820T

The following is a list of behaviors and limitations regarding the use of DCB over S4820T ports involved in switch stacking:

- You can enable DCB only on 40 Gig (QSPF+) ports.
- DCB is not supported over any of the 48 RJ-45 10 Gig ports while they are configured in stacking mode.
- You cannot configure stacking on any of the 48 RJ-45 10 Gig ports, if DCB is enabled on any of the 40 Gig stacking ports.
- If DCB is enabled, it will disable the ability to use any of the 48 10 Gig ports for stacking.

Using the FTOS stacking feature, multiple S-Series switch units can be interconnected with dedicated stacking ports or front end user ports. (The S50, S55, and S60 use dedicated stacking ports; the S4810 and S4820T use front end user ports for stacking.) The stack becomes manageable as a single switch through the stack management unit.

This chapter contains the following sections:

- [S-Series Stacking Overview](#)
- [Stack Management Roles](#)
- [Stack Master Election](#)

- [Stack Group/Port Numbers](#)
- [High Availability on S-Series Stacks](#)
- [Important Points to Remember - S4810 and S4820T Stacking](#)
- [S-Series Stacking Configuration Tasks](#)
- [Troubleshoot an S-Series Stack](#)
- [Removing Units or Front End Ports from a Stack](#)

S-Series Stacking Overview

An S-Series stack is analogous to an E-Series or C-Series system with redundant RPMs and multiple line cards. FTOS elects a management (master) unit, a standby unit, and all other units are member units.

FTOS presents all of the units like line cards; for example, to access GigabitEthernet Port 1 on Stack Unit 0, enter **interface gigabitethernet 0/1** from CONFIGURATION mode.

Stack Management Roles

The stack elects the management units for the stack management:

- **Stack master:** The primary management unit, also called the **master** unit.
- **Standby:** The secondary management unit.
- **Stack units:** Also called **stack members**, these are the remaining units in the stack.
- **Stack group:** On the S4810 and S4820T, each set of 4 10G ports or each individual 40G port correspond to a stack-group. The CLI is used to configure the front ports on the S4810 or S4820T to be stacking-ports.

The master holds the control plane and the other units maintain a local copy of the forwarding databases. From the stack master you can configure:

- System-level features that apply to all stack members.
- Interface-level features for each stack member.

The master synchronizes the following information with the standby unit:

- Stack unit topology
- Stack running configuration (which includes ACL, LACP, STP, SPAN, etc.)
- Logs

The master switch maintains stack operation with minimal impact in the event of:

- Switch failure
- Inter-switch stacking link failure
- Switch insertion

- Switch removal

If the master switch goes off line, the standby replaces it as the new master and the switch with the next highest priority or MAC address becomes standby.

Stack Master Election

The stack elects a master and standby unit at bootup time based on two criteria:

- Unit priority: User-configurable. Range is from 1 to 14. A higher value (14) means a higher priority. Default: 1. By removing the stack-unit priority using the **no stack-unit priority** command, you can set the priority back to the default value of zero. The unit with the highest priority is elected the master management unit; the unit with the second highest priority is elected the standby unit.
- MAC address (in case of priority tie): The unit with the higher MAC value becomes the master unit. The stack takes the MAC address of the master unit and retains it unless it is reloaded.

To view which switch is the stack master, enter the **show system** command. [Figure 46-1](#) shows sample output from an established stack.

A change in the stack master occurs when:

- You power down the stack master or bring the master switch offline.
- A failover of the master switch occurs.
- You disconnect the master switch from the stack.

When a stack reloads and all the units come up at the same time, for example, when all units boot up from flash, all units participate in the election and the master and standby are chosen based on the priority or MAC address. When the units do not boot up at the same time, such as when some units are powered down just after reloading and powered up later to join the stack, they do not participate in the election process even though the units that boot up late may have a higher priority configured. This happens because the master and standby have already been elected, hence the unit that boots up late joins only as a member. When an up and running standalone unit or stack is merged with another stack, based on election, the losing stack reloads and the master unit of the winning stack becomes the master of the merged stack. For more details, see sections “[Add Units to an Existing S-Series Stack on page 926](#)” and “[Remove a Unit from an S-Series Stack on page 937](#)”. It is possible to reset individual units to force them to give up the management role or reload the whole stack from the CLI to ensure a fully synchronized bootup.

Figure 46-1. Displaying the Stack Master

```
FTOS#show system brief

Stack MAC : 00:01:e8:8c:53:32

Reload Type : normal-reload [Next boot : normal-reload]

-- Stack Info --
Unit  UnitType   Status      ReqTyp      CurTyp      Version     Ports
-----
0     Member       not present
1     Management   online      S4810       S4810       4810-8-3-12-1447 64
2     Standby      online      S4810       S4810       4810-8-3-12-1447 64
3     Member       online      S4810       S4810       4810-8-3-12-1447 64
```

| | | | | | | |
|----|--------|-------------|-------|-------|------------------|----|
| 4 | Member | online | S4810 | S4810 | 4810-8-3-12-1447 | 64 |
| 5 | Member | not present | | | | |
| 6 | Member | not present | | | | |
| 7 | Member | not present | | | | |
| 8 | Member | not present | | | | |
| 9 | Member | not present | | | | |
| 10 | Member | not present | | | | |

Virtual IP

The stack can be managed using a single IP, known as a virtual IP, that is retained in the stack even after a failover. The virtual IP address is used to log in to the current master unit of the stack. Both IPv4 and IPv6 addresses are supported as virtual IPs.

Failover Roles

If the stack master fails (e.g., is powered off), it is removed from the stack topology. The standby unit detects the loss of peering communication and takes ownership of the stack management, switching from the standby role to the master role. The distributed forwarding tables are retained during the failover, as is the stack MAC address. The lack of a standby unit triggers an election within the remaining units for a standby role.

Once the former master switch recovers, despite having a higher priority or MAC address, it will not recover its master role but instead takes the next available role.

To view failover details, use the **show redundancy** command.

MAC Addressing on S-Series Stacks

The S-Series has three MAC addresses: the chassis MAC, interface MAC, and null interface MAC. All interfaces in the stack use the interface MAC address of the management unit, and the chassis MAC for the stack is the master's chassis MAC. The stack continues to use the master's chassis MAC address even after a failover. The MAC address is not refreshed until the stack is reloaded and a different unit becomes the stack manager.



Note: If the removed management unit is brought up as a standalone unit or as part of a different stack, there is a possibility of MAC address collisions.

In [Figure 46-2](#) and [Figure 46-3](#), a standalone is added to a stack. The standalone and the master unit have the same priority, but the standalone has a lower MAC address, so the standalone reboots. In [Figure 46-3](#), a standalone is added to a stack. The standalone has a higher priority than the stack, so the stack (excluding the new unit) reloads.

Figure 46-2. Adding a Standalone with a Lower MAC Address to a Stack— Before (S50-type)

```
-----STANDALONE BEFORE CONNECTION-----
Standalone#show system brief

Stack MAC : 00:01:e8:d5:ef:81

-- Stack Info --
Unit  UnitType   Status      ReqTyp     CurTyp     Version   Ports
-----
  0   Management  online      S50V       S50V       7.8.1.0   52
  1   Member      not present
  2   Member      not present
  3   Member      not present
  4   Member      not present
  5   Member      not present
  6   Member      not present
  7   Member      not present
[output omitted]
Standalone#show system | grep priority
Master priority : 0
-----STACK BEFORE CONNECTION-----
Stack#show system brief

Stack MAC : 00:01:e8:d5:f9:6f

-- Stack Info --
Unit  UnitType   Status      ReqTyp     CurTyp     Version   Ports
-----
  0   Standby    online      S50V       S50V       7.8.1.0   52
  1   Management  online      S50N       S50N       7.8.1.0   52
  2   Member      not present
  3   Member      not present
  4   Member      not present
  5   Member      not present
  6   Member      not present
  7   Member      not present
[output omitted]
Stack#show system stack-unit 0 | grep priority
Master priority : 0
Stack#show system stack-unit 1 | grep priority
Master priority : 0
```

Figure 46-3. Adding a Standalone with a Lower MAC Address and Equal Priority to a Stack—After

```

-----STANDALONE AFTER CONNECTION-----
Standalone#%STKUNIT0-M:CP %POLLGR-2-ALT_STACK_UNIT_STATE: Alternate Stack-unit is present
00:20:20: %STKUNIT0-M:CP %CHMGR-5-STACKUNITDETECTED: Stack unit 1 present
00:20:22: %STKUNIT0-M:CP %CHMGR-5-STACKUNITDETECTED: Stack unit 2 present

Going for reboot. Reason is Stack merge
[bootup messages omitted]
-----STACK AFTER CONNECTION-----
Stack# 3wld14h: %STKUNIT1-M:CP %CHMGR-5-STACKUNITDETECTED: Stack unit 2 present
3wld14h: %STKUNIT1-M:CP %CHMGR-2-STACKUNIT_DOWN: Stack unit 2 down - card removed
3wld14h: %STKUNIT1-M:CP %CHMGR-5-STACKUNITDETECTED: Stack unit 2 present
3wld14h: %STKUNIT1-M:CP %CHMGR-5-CHECKIN: Checkin from Stack unit 2 (type S50V, 52 ports)
3wld14h: %S50V:2 %CHMGR-0-PS_UP: Power supply 0 in unit 2 is up
3wld14h: %STKUNIT1-M:CP %CHMGR-5-STACKUNITUP: Stack unit 2 is up

Stack#show system brief

Stack MAC : 00:01:e8:d5:f9:6f

-- Stack Info --
Unit  UnitType      Status      ReqTyp      CurTyp      Version      Ports
-----
  0   Standby       online      S50V        S50V        7.8.1.0      52
  1   Management    online      S50N        S50N        7.8.1.0      52
  2   Member         online      S50V        S50V        7.8.1.0      52
  3   Member         not present
  4   Member         not present
  5   Member         not present
  6   Member         not present
  7   Member         not present

```

Stacking LAG

When multiple links are used between stack units, FTOS automatically bundles them in a stacking LAG to provide aggregated throughput and redundancy. The stacking LAG is established automatically and transparently by FTOS (without user configuration) once peering is detected and behaves as follows:

- The stacking LAG dynamically aggregates; it can lose link members or gain new links.
- Shortest path selection inside the stack: If multiple paths exist between two units in the stack, the shortest path is used.

Supported Stacking Topologies

The S4810 and S4820T support stacking in a ring or a daisy chain topology. Dell Force10 recommends the ring topology when stacking S4810 or S4820T switches to provide redundant connectivity.

Figure 46-4. S4810 supported stacking topologies

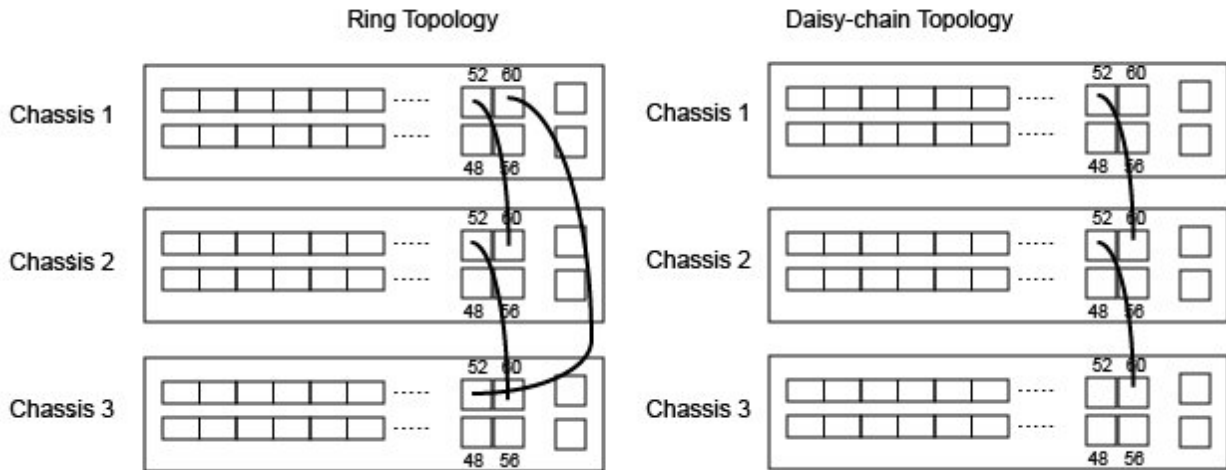

High Availability on S-Series Stacks

S-Series stacks have master and standby management units analogous to Dell Force10 Route Processor Modules (Figure 46-5). The master unit synchronizes the running configuration and protocol states so that the system fails over in the event of a hardware or software fault on the master unit. In such an event, or when the master unit is removed, the standby unit becomes the stack manager and FTOS elects a new standby unit. FTOS resets the failed master unit: once online, it becomes a member unit; the remaining members remain online.

Figure 46-5. S-Series Stack Manager Redundancy (S50-type system)

```

Stack#show redundancy

-- Stack-unit Status --
-----
Mgmt ID:                0
Stack-unit ID:          1
Stack-unit Redundancy Role: Primary
Stack-unit State:       Active
Stack-unit SW Version:  7.8.1.0
Link to Peer:           Up

-- PEER Stack-unit Status --
-----
Stack-unit State:       Standby
Peer stack-unit ID:    2
Stack-unit SW Version:  7.8.1.0

-- Stack-unit Redundancy Configuration --
-----
Primary Stack-unit:      mgmt-id    0
Auto Data Sync:          Full
Failover Type:           Hot Failover
Auto reboot Stack-unit:  Enabled
Auto failover limit:     3 times in 60 minutes

-- Stack-unit Failover Record --
-----
Failover Count:          0
Last failover timestamp: None
Last failover Reason:    None
Last failover type:      None

--Last Data Block Sync Record: --
-----
Stack Unit Config: succeeded Mar 24 2009 20:35:14
Start-up Config: failed Mar 24 2009 20:35:14
Runtime Event Log: succeeded Mar 24 2009 20:35:14
Running Config: succeeded Mar 24 2009 20:35:14
ACL Mgr: succeeded Mar 24 2009 20:35:14
      LACP:          no block sync done
      STP:           no block sync done
      SPAN:          no block sync done

```

Management Access on S-Series Stacks

You can access the stack via the console port or VTY line.

- **Console access:** You may access the stack through the console port of the master unit (stack manager) only. Like a standby RPM, the console port of the standby unit does not provide management capability; only a limited number of commands are available. Member units provide a severely limited set of commands, as shown in [Figure 46-6](#).
- **Remote access:** You may access the master unit and standby unit in a stack through the dedicated management ethernet interfaces with SNMP, SSH, or via Telnet.

Figure 46-6. Accessing Non-Master Units on a Stack via the Console Port

```
-----CONSOLE ACCESS ON THE STANDBY-----
2-unit-stack(standby)#?
cd                               Change current directory
clear                            Reset functions
copy                             Copy from one file to another
delete                           Delete a file
dir                               List files on a filesystem
disable                          Turn off privileged commands
enable                           Turn on privileged commands
exit                             Exit from the EXEC
format                           Format a filesystem
package                          automation package related commands
pwd                              Display current working directory
rename                           Rename a file
reset                            Reset selected card
show                             Show running system information
ssh-peer-stack-unit             Open a SSH connection to the peer Stack-unit
start                            Start shell
telnet-peer-stack-unit          Open a telnet connection to the peer Stack-unit
terminal                        Set terminal line parameters
upload                          Upload file
-----CONSOLE ACCESS ON A MEMBER-----
Stack(stack-member-0)#?
reset-self                       Reset this unit alone
show                             Show running system information
```

Stacking Cable Redundancy

You can connect two units with two or more stacking cables in case of a stacking port or cable failure. Removal of only one of the cables does not trigger a reset.

Important Points to Remember - S4810 and S4820T Stacking



Note: This release of FTOS does not support the mixed stacking of S4810s with S4820Ts.

- For S4810 and S4820T stacking using 40GE ports, any remaining 40 GE ports should not be configured as quad-mode.
- You may stack up to six S4810 or S4820T systems
- The S4810 and S4820T cannot be stacked with other system types.
- Stacking and Virtual Link Trunking (VLT) *cannot* be enabled simultaneously on the S4810 or S4820T. To convert a stacked unit to VLT, refer to [Reconfiguring Stacked Switches as VLT](#).
- Data ports are configured as stacking ports in predefined groups of 4-10G ports called stack-groups. When using the 40G ports, a single port can be configured as a stack port; each 40G port is a stack-group.
- All the ports in a stack-group are placed in stacking mode. Unused ports in that group cannot be used as data ports.
- The stack-group must contain only ports of the same type (all 10G or all 40G).

- Stacking with 1G interfaces is *not* supported.
- Stacking on the S4810 and S4820T is accomplished through front end user ports on the chassis
- All stack units must have the same version of FTOS.

S-Series Stacking Installation Tasks

- [Create an S-Series Stack](#)
- [Add Units to an Existing S-Series Stack](#)
- [Remove a Unit from an S-Series Stack](#)
- [Split an S-Series Stack](#)

Create an S-Series Stack

Stacking is enabled on the S4810 and S4820T using the front end ports. No configuration is allowed on front end ports used for stacking. Stacking can be made between 10G ports of two units or 40G ports of two units. The stack links between the two units will be grouped into a single LAG.

Stack Group/Port Numbers

By default, each unit in standalone mode is numbered stack-unit 0. A maximum of eight 10G stack links or two 40G stack links can be made between two units in a stack. The front end ports are divided into 16 stack groups, each with 40G of bandwidth. Stack groups 0 through 11 correspond to 10G stack groups with four ports each. Stack groups 12 to 15 are one 40G port each.

The front end ports accommodate SFP, SFP+ and QSFP+.

- Ports are divided into 16 stack-groups (0 to 15) as shown in the following example. The stack groups must be of a single speed - either all 10G or all 40G.
 - stack-group 0 corresponds to ports 0-3, stack-group 1 corresponds to ports 4-7, so on through stack-group 11
 - stack-group 12 corresponds to the 40G port 48, stack-group 13 corresponds to port 52, so on through stack group 15.

Figure 46-7. S4810 Stack-group assignments

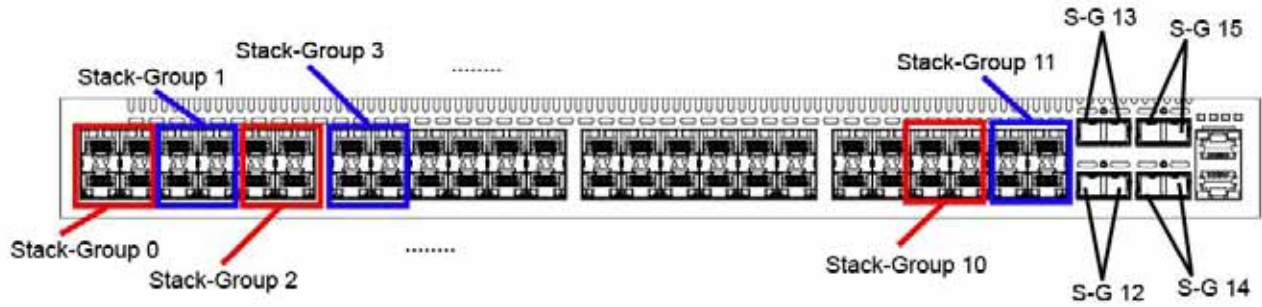

Figure 46-8. S4820T Stack-Group Assignment



You can connect the units while they are powered down or up. Stacking ports are bi-directional.

With FTOS 8.3.12.0, when a unit is added to a stack, the management unit performs a system check on the new unit to ensure the hardware type is compatible. A similar check is performed on the FTOS version. If the stack is running 8.3.12.0 and the new unit is running an earlier software version, the new unit is put into a card problem state.

- If the unit is running version 8.3.10.x, it is upgraded to use the same FTOS version as the stack, rebooted and join the stack.
- If the new unit is running an FTOS version prior to 8.3.10.x, the unit is put into a card problem state, FTOS is not upgraded, and a syslog message is raised. The unit must be upgraded to FTOS 8.3.12.0 before you can proceed.

Syslog messages are generated by the management unit:

- before the management unit downloads its FTOS version (FTOS 8.3.12.0 or later) to the new unit. The syslog includes the unit number, previous version and version being downloaded.
- when the firmware synchronization is complete.
- if the system check fails, a message such as a hardware incompatibility message or incompatible uboot version is generated. If the unit is placed in a card problem state, the management unit also generates an SNMP trap.

- if the software version of the new unit predates FTOS 8.3.12.0, the management unit puts the new unit into a card problem state and generates a syslog that identifies the unit, its FTOS version, and its incompatibility for firmware synchronization.



Note: You must enter the **stack-unit *stack-unit* stack-group *stack-group*** command when adding units to a stack to ensure the units are assigned to the correct groups.



Note: Any scripts used to streamline the stacking configuration process must be updated to reflect the Command Mode change from EXEC to CONFIGURATION to allow the scripts to work correctly.

Enable Front End Port Stacking

To enable the front ports on an S4810 or S4820T unit for stacking, use the following procedure.



Note: Once a port has been allocated for stacking, it can only be used for stacking. If stack-group 0 is allocated for stacking, then ports 0, 1, 2, and 3 can be used for stacking but not for Ethernet anymore. If only port 0 is used for stacking, ports 1, 2, and 3 are just spare; they cannot be used for Ethernet.

After the front ports are enabled, use the **show system stack-unit** command to view the port assignments,

| Task | Command Syntax | Command Mode |
|--|---|----------------|
| Assign a stack group for each unit. Begin with the first port on the management unit. Next, configure both ports on each subsequent unit. Finally, return to the management unit and configure the <i>last</i> port. (See the example below.) Range: 0-15 | stack-unit <i>id</i> stack-group <i>id</i> | CONFIGURATION |
| Save the stacking configuration on the ports. | write memory | EXEC Privilege |
| Reload the switch. FTOS automatically assigns a number to the new unit and adds it as member switch in the stack. The new unit synchronizes its running and startup configurations with the stack. | reload | EXEC Privilege |

After the units are reloaded, the system reboots. The units come up in a stack after the reboot completes.

```

FTOS#configure terminal
FTOS(conf)#
FTOS(conf)#stack-unit 0 stack-group 0
FTOS(conf)#00:20:30: %STKUNIT0-M:CP %IPMR-6-STACK_PORTS_ADDED: Ports Te 0/0 Te 0/1 Te 0/2 Te 0/3 have been configured as stacking ports. Please save and reload for co
nfig to take effect

FTOS(conf)#stack-unit 0 stack-group 7
FTOS(conf)#00:20:26: %STKUNIT0-M:CP %IPMR-6-STACK_PORTS_ADDED: Ports Te 0/28 Te 0/29 Te 0/30 Te 0/31 have been configured as stacking ports. Please save and reload fo
r config to take effect

FTOS(conf)#end
FTOS#00:20:30: %STKUNIT0-M:CP %SYS-5-CONFIG_I: Configured from console
00:20:31: %S4810:0 %FANMGR-1-FAN_SPEED_CHANGE: Fan speed changed to 60 % of the full speed

FTOS#
FTOS#write memory
!
00:20:38: %STKUNIT0-M:CP %FILEMGR-5-FILESAVED: Copied running-config to startup-config in flash by default

FTOS#
FTOS#reload

Proceed with reload [confirm yes/no]: y
syncing disks... done
rebooting

```

Creating a New Stack

Prior to creating a stack, know which unit will be the management unit and which will be the standby unit. You must also enable the front ports of the units for stacking. For more information, see [“Enable Front End Port Stacking” on page 922](#).

To create a new stack:

| Step | Task | Command Syntax | Command Mode |
|------|---|---|----------------|
| 1 | Power up all units in the stack | | |
| 2 | Verify that each unit has the same FTOS version prior to stacking them together. | show version | EXEC Privilege |
| 3 | Manually configure unit numbers for each unit, so that the stacking is deterministic upon boot up. Renumbering will cause the unit to reboot. The stack-unit default for all new units is stack-unit 0. | stack-unit 0 renumber | EXEC Privilege |
| 4 | Configure the switch priority for each unit to make management unit selection deterministic. | stack-unit priority | CONFIGURATION |
| 5 | Assign a stack group for each unit. Begin with the first port on the management unit. Next, configure both ports on each subsequent unit. Finally, return to the management unit and configure the <i>last</i> port. (See the example below.) Range: 0 to 15 | stack-unit <i>id</i> stack-group <i>id</i> | CONFIGURATION |
| 6 | Connect the units using stacking cables. Note: The S4810 and S4820T do not require special stacking cables. The cables used to connect the data ports are sufficient. | | |

| Step | Task | Command Syntax | Command Mode |
|------|--|--------------------------|----------------|
| 7 | Reload the stack one unit at a time. Start with the management unit, then the standby, followed by each of the members in order of their assigned stack number (or the position in the stack you want each unit to take). Allow each unit to completely boot, and verify that the unit is detected by the stack manager, and then power the next unit. | show system brief | EXEC Privilege |

In the following example, stack unit 1 will be the master management unit, stack unit 2 will be the standby unit. The cables are connected to each unit.

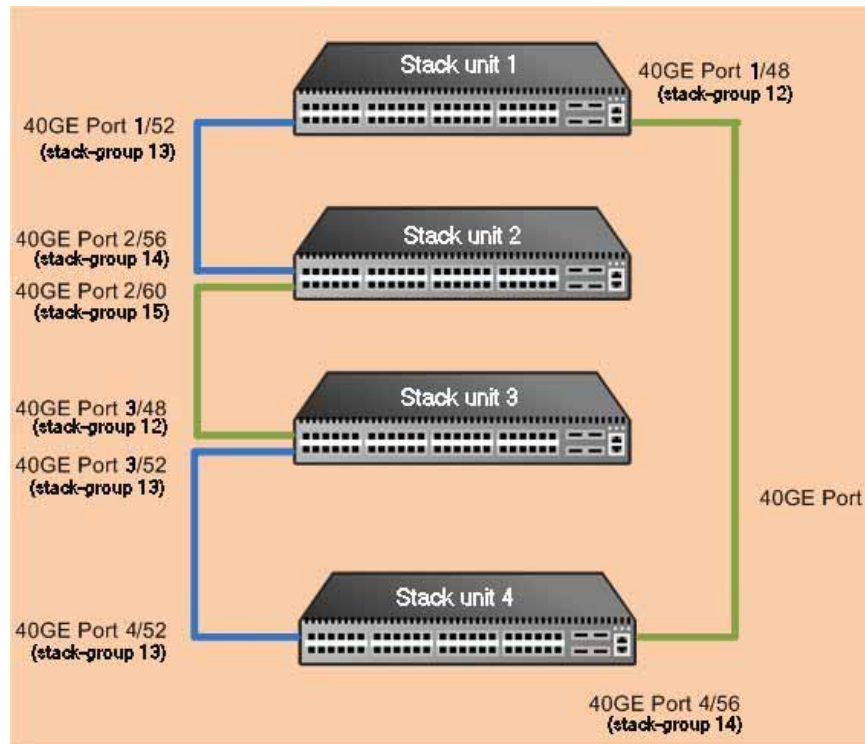

Configure the stack groups on the units in the following order:

Configure the first stack group on unit 1:

```
stack-unit 1 stack-group 13
```

Configure the stack groups on unit 2:

```
stack-unit 2 stack-group 14  
stack-unit 2 stack-group 15
```

Configure the stack groups on unit 3:

stack-unit 3 stack-group 12

stack-unit 3 stack-group 13

Configure the stack groups on unit 4:

stack-unit 4 stack-group 13

stack-unit 4 stack-group 14

Configure the final stack-group on unit 1 to complete the stack.

stack-unit 1 stack-group 12

When the stack-group configuration is complete, the system will print a syslog for reload, as shown below.

```
FTOS#configure
FTOS(conf)#stack-unit 4 stack-group 13
FTOS(conf)#02:39:12: %STKUNIT4-M:CP %IFMGR-6-STACK_PORTS_ADDED: Ports Fo 4/52 have been configured as
stacking ports. Please save and reload for config To take effect
FTOS(conf)#stack-unit 4 stack-group 14
FTOS(conf)#02:39:15: %STKUNIT4-M:CP %IFMGR-6-STACK_PORTS_ADDED: Ports Fo 4/56 have been configured as
stacking ports. Please save and reload for config To take effect
FTOS(conf)#
FTOS#02:39:18: %STKUNIT4-M:CP %SYS-5-CONFIG_I: Configured from console
```

Reload each unit in the stack. After the reload is complete, the four units will come up as a stack with unit 1 as the management unit, unit 2 as the standby unit, and the remaining units as stack-members as shown in the following example. All units in the stack can be accessed from the management unit.

```
FTOS#show system brief
```

```
Stack MAC : 00:01:e8:8c:53:32
```

```
Reload Type : normal-reload [Next boot : normal-reload]
```

```
-- Stack Info --
```

| Unit | UnitType | Status | ReqTyp | CurTyp | Version | Ports |
|------|------------|-------------|--------|--------|------------------|-------|
| 0 | Member | not present | | | | |
| 1 | Management | online | S4810 | S4810 | 4810-8-3-12-1447 | 64 |
| 2 | Standby | online | S4810 | S4810 | 4810-8-3-12-1447 | 64 |
| 3 | Member | online | S4810 | S4810 | 4810-8-3-12-1447 | 64 |
| 4 | Member | online | S4810 | S4810 | 4810-8-3-12-1447 | 64 |
| 5 | Member | not present | | | | |
| 6 | Member | not present | | | | |
| 7 | Member | not present | | | | |
| 8 | Member | not present | | | | |
| 9 | Member | not present | | | | |
| 10 | Member | not present | | | | |

```
-- Power Supplies --
```

| Unit | Bay | Status | Type | FanStatus |
|------|-----|--------|---------|-----------|
| 1 | 0 | absent | | absent |
| 1 | 1 | up | AC | up |
| 2 | 0 | down | UNKNOWN | down |
| 2 | 1 | up | AC | up |
| 3 | 0 | absent | | absent |
| 3 | 1 | up | AC | up |
| 4 | 0 | absent | | absent |
| 4 | 1 | up | AC | up |

```
-- Fan Status --
```

| Unit | Bay | TrayStatus | Fan0 | Speed | Fan1 | Speed |
|------|-----|------------|------|-------|------|-------|
| 1 | 0 | up | up | 9360 | up | 9360 |
| 1 | 1 | up | up | 9360 | up | 9360 |
| 2 | 0 | up | up | 7680 | up | 7680 |
| 2 | 1 | up | up | 7920 | up | 7680 |
| 3 | 0 | up | up | 9360 | up | 9360 |
| 3 | 1 | up | up | 9360 | up | 9360 |
| 4 | 0 | up | up | 9120 | up | 9120 |
| 4 | 1 | up | up | 9120 | up | 9360 |

Speed in RPM

The following example shows how to configure two new S4810 or S4820T switches for stacking using 10G ports.

```
S4810-1(conf)#stack-unit 0 stack-group 0
Setting ports Te 0/0 Te 0/1 Te 0/2 Te 0/3 as stack group will make their interface configs obsolete after
a reload.
[confirm yes/no]:yes
```

```
S4810-2(conf)#stack-unit 0 stack-group 0
Setting ports Te 0/0 Te 0/1 Te 0/2 Te 0/3 as stack group will make their interface configs obsolete after
a reload.
[confirm yes/no]:yes
```

```
S4810-1#show system stack-ports
```

Topology: Ring

| Interface | Connection | Link Speed (Gb/s) | Admin Status | Link Status | Trunk Group |
|-----------|------------|----------------------|-----------------|----------------|----------------|
| 0/0 | 1/0 | 10 | up | up | |
| 0/1 | 1/1 | 10 | up | up | |
| 0/2 | 1/2 | 10 | up | up | |
| 0/3 | 1/3 | 10 | up | up | |

```
S4810-1#
```

Add Units to an Existing S-Series Stack

Units can be added to an existing stack in one of three ways:

- by manually assigning a new un-configured unit a position in an existing stack.
- by adding a configured unit to an existing stack.
- by merging two stacks.

If you are adding units to an existing stack, you can either:

- allow FTOS to automatically assign the new unit a position in the stack, or
- manually determine each unit's position in the stack by configuring each unit to correspond with the stack before connecting it.
- If you add a unit that has a stack number that conflicts with the stack, the stack assigns the first available stack number, as shown in the examples below.

- If the stack has a provision for the stack-number that will be assigned to the new unit, the provision must match the unit type, or FTOS generates a type mismatch error, as shown in [Figure 46-11](#) and [Figure 46-12](#).

After the new unit loads, it synchronizes its running and startup configurations with the stack.

Manually Assign a New Unit to an Existing Stack

To manually assign a new unit a position in an existing stack, use the following steps.



Note: For an S50 system, install stacking modules in the new unit while the unit is unpowered.

| Step | Task | Command Syntax | Command Mode |
|------|--|---|----------------|
| 1 | On the stack, determine the next available stack-unit number, and the management priority of the management unit. | show system brief show system stack-unit | EXEC Privilege |
| 2 | On the new unit, number it the next available stack-unit number. | stack-unit renumber | EXEC Privilege |
| 3 | (OPTIONAL) On the new unit, assign a management priority based on whether you want the new unit to be the stack manager. | stack-unit priority | CONFIGURATION |
| 4 | Assign a stack group to each unit. | stack-unit id stack-group id | CONFIGURATION |
| 5 | Connect the new unit to the stack using stacking cables. | | |

Figure 46-9. Adding an S4810 or S4820T Stack Unit with a Conflicting Stack Number—Before

```
FTOS#show system brief
Stack MAC : 00:01:e8:8a:df:e6

Reload Type : normal-reload

-- Stack Info --
Unit  UnitType   Status      ReqTyp      CurTyp      Version     Ports
-----
 0   Management  online      S4810       S4810       8-3-7-13   64
 1   Member      not present
 2   Member      not present
 3   Standby     online      S4810       S4810       8-3-7-13   64
 4   Member      not present
 5   Member      not present
 6   Member      not present
 7   Member      not present
 8   Member      not present
 9   Member      not present
10   Member      not present
11   Member      not present
```

Figure 46-10. Adding an S4810 or S4820T Stack Unit with a Conflicting Stack Number—After

```
FTOS#show system brief
Stack MAC : 00:01:e8:8a:df:e6
```

Reload Type : normal-reload

```
-- Stack Info --
Unit  UnitType      Status      ReqTyp      CurTyp      Version      Ports
-----
 0  Management  online      S4810       S4810       8-3-7-13     64
 1  Member      online      S4810       S4810       8-3-7-13     64
 2  Member      not present
 3  Standby     online      S4810       S4810       8-3-7-13     64
 4  Member      not present
 5  Member      not present
 6  Member      not present
 7  Member      not present
 8  Member      not present
 9  Member      not present
10  Member      not present
11  Member      not present
```

Add a Configured Unit to an Existing Stack

To add a configured unit to an existing stack use the following steps.

If a stack unit goes down and is removed from the stack, the logical provisioning configured for that stack-unit number is saved on the master and standby units. When a new unit is added to the stack, if a stack group configuration conflict occurs between the new unit and the provisioned stack unit, the configuration of the new unit takes precedence.

| Step | Task | Command Syntax | Command Mode |
|------|--|---|----------------|
| 1 | Add the configured unit to the top or bottom of the stack. | | |
| 2 | Power on the switch. | | |
| 3 | Attach cables to connect ports on the added switch to one or more existing switches in the stack. | | |
| 4 | Logon to the CLI and enter global configuration mode. | Login: username Password: ***** FTOS> enable FTOS# configure | |
| 5 | Configure the ports on the added switch for stacking, where: stack-unit 0 defines the default ID unit-number in the initial configuration of a switch. stack-group <i>group-number</i> configures a port for stacking. | stack-unit 0 stack-group <i>group-number</i> | CONFIGURATION |
| 6 | Save the stacking configuration on the ports. | write memory | EXEC Privilege |
| 7 | Reload the switch. FTOS automatically assigns a number to the new unit and adds it as member switch in the stack. The new unit synchronizes its running and startup configurations with the stack. | reload | EXEC Privilege |

If a standalone switch already has stack groups configured.

| Step | Task | Command Syntax | Command Mode |
|------|---|----------------|--------------|
| 8 | Attach cables to connect the ports already configured as stack groups on the switch to one or more switches in the stack. | | |
| 9 | FTOS automatically assigns a number to the new unit and adds it as member switch in the stack. The new unit synchronizes its running and startup configurations with the stack. | | |



FTOS Behavior: When you add a new switch to a stack:

- If the new unit has been configured with a stack number that is already assigned to a stack member, the stack avoids a numbering conflict by assigning the new switch the first available stack number.
- If the stack has been provisioned for the stack number that is assigned to the new unit, the pre-configured provisioning must match the switch type. If there is a conflict between the provisioned switch type and the new unit, a mismatch error message is displayed.

Merge Two S-Series Stacks

You may merge two stacks while they are powered and online. To merge two stacks, connect one stack to the other using user port cables from the front end user port.

- FTOS selects a master stack manager from the two existing managers based on the priority of the stack.
- FTOS resets all the units in the losing stack; they all become stack members.
- If there is no unit numbering conflict, the stack members retain their previous unit numbers. Otherwise, the stack manager assigns new unit numbers, based on the order that they come online.
- The stack manager overwrites the startup and running config on the losing stack members with its own to synchronize the configuration on the new stack members.

Split an S-Series Stack

To split a stack, unplug the desired stacking cables. You may do this at any time, whether the stack is powered or unpowered, and the units are online or offline. Each portion of the split stack retains the startup and running configuration of the original stack.

For a parent stack that is split into two child stacks, A and B, each with multiple units:

- If one of the new stacks receives the master and the standby management units, it is unaffected by the split.
- If one of the new stacks receives only the master unit, that unit remains the stack manager, and FTOS elects a new standby management unit.
- If one of the new stacks receives only the standby unit, it becomes the master unit of the new stack, and FTOS elects a new standby unit.
- If one of the new stacks receives neither the master nor the standby management unit, the stack is reset so that a new election can take place.

S-Series Stacking Configuration Tasks

- [Assign Unit Numbers to Units in an S-Series Stack](#)
- [Create a Virtual Stack Unit on an S-Series Stack](#)
- [Display Information about an S-Series Stack](#)
- [Influence Management Unit Selection on an S-Series Stack](#)
- [Manage Redundancy on an S-Series Stack](#)
- [Reset a Unit on an S-Series Stack](#)
- [Recover from Stack Link Flaps](#)

Assign Unit Numbers to Units in an S-Series Stack

Each unit in the stack has a stack number that is either assigned by you or FTOS. Units are numbered from 0 to 11, however, only six (6) S4810 or S4820T units can be stacked. Stack numbers are stored in NVRAM and are preserved upon reload.

| Task | Command Syntax | Command Mode |
|----------------------------------|----------------------------|----------------|
| Assign a stack-number to a unit. | stack-unit renumber | EXEC Privilege |



Note: Renumbering the stack manager triggers the whole stack to reload as indicated in [Message 1](#). When the stack comes back online, the master unit remains the management unit.

Message 1 Renumbering the Stack Manager

```
Renumbering master unit will reload the stack.
WARNING: Interface configuration for current unit will be lost!
Proceed to renumber [confirm yes/no]: yes
```

Create a Virtual Stack Unit on an S-Series Stack

Use virtual stack units to configure ports on the stack before adding a new unit.

| Task | Command Syntax | Command Mode |
|------------------------------|-----------------------------|---------------|
| Create a virtual stack unit. | stack-unit provision | CONFIGURATION |

Display Information about an S-Series Stack

| Task | Command Syntax | Command Mode |
|---|--------------------|----------------|
| Display for stack-identity, status, and hardware information on every unit in a stack. See the example below. | show system | EXEC Privilege |

| Task | Command Syntax | Command Mode |
|---|--|----------------|
| Display most of the information in show system , but in a more convenient tabular form. See the example below. | show system brief | EXEC Privilege |
| Display the same information in show system , but only for the specified unit. See the example below. | show system stack-unit | EXEC Privilege |
| Display topology and stack link status for the entire stack. The available options separate the show system stack-port output into topology information from link status information. See the example below. | show system stack-ports [status topology] | EXEC Privilege |

Display information about an S4810 or S4820T stack using the **show system** command.

```

Forcel10#show system
Stack MAC : 00:01:e8:8a:df:e6
Reload Type : normal-reload
-- Unit 0 --
Unit Type      : Management Unit
Status         : online
Next Boot      : online
Required Type  : S4810 - 52-port GE/TE/FG (SE)
Current Type   : S4810 - 52-port GE/TE/FG (SE)
Master priority : 0
Hardware Rev   : 3.0
Num Ports      : 64
Up Time        : 57 min, 0 sec
FTOS Version   : 8-3-7-13
Jumbo Capable  : yes
POE Capable    : no
Burned In MAC  : 00:01:e8:8a:df:e6
No Of MACs     : 3

-- Power Supplies --
Unit  Bay  Status      Type      FanStatus
-----
  0    0    absent          AC        absent
  0    1    up              AC        up

-- Fan Status --
Unit Bay  TrayStatus  Fan0    Speed  Fan1    Speed
-----
  0    0    up          up     6960   up     6960
  0    1    up          up     6720   up     6720

Speed in RPM

-- Unit 1 --
Unit Type      : Member Unit
Status         : not present
Required Type  : S4810 - 52-port GE/TE/FG (SE)

-- Unit 2 --
Unit Type      : Member Unit
Status         : not present

-- Unit 3 --

```

```

Unit Type       : Standby Unit
Status          : online
Next Boot       : online
Required Type   : S4810 - 52-port GE/TE/FG (SE)
Current Type    : S4810 - 52-port GE/TE/FG (SE)
Master priority : 0
Hardware Rev    : 3.0
Num Ports      : 64
Up Time         : 57 min, 3 sec
FTOS Version    : 8-3-7-13
Jumbo Capable   : yes
POE Capable     : no
Burned In MAC   : 00:01:e8:8a:df:bf
No Of MACs      : 3

```

-----output truncated-----

Display information about an S4810 or S4820T stack using the **show system brief** command

```
FTOS#show system brief
```

```
Stack MAC : 00:01:e8:8a:de:48
```

```
Reload Type : normal-reload
```

```
-- Stack Info --
```

| Unit | UnitType | Status | ReqTyp | CurTyp | Version | Ports |
|------|------------|-------------|--------|--------|-----------|-------|
| 0 | Member | not present | | | | |
| 1 | Member | not present | | | | |
| 2 | Member | not present | | | | |
| 3 | Management | online | S4810 | S4810 | 8-3-12-13 | 64 |
| 4 | Member | not present | | | | |
| 5 | Member | not present | | | | |
| 6 | Member | not present | | | | |
| 7 | Member | not present | | | | |
| 8 | Member | not present | | | | |
| 9 | Member | not present | | | | |
| 10 | Member | not present | | | | |
| 11 | Member | not present | | | | |

Display information about an S4810 or S4820T stack using the **show system stack-ports** command.

```
FTOS#show system stack-ports
```

```
Topology: Ring
```

| Interface | Connection | Link Speed (Gb/s) | Admin Status | Link Status | Trunk Group |
|-----------|------------|----------------------|-----------------|----------------|----------------|
| 0/56 | 3/56 | 40 | up | up | |
| 0/60 | 3/60 | 40 | up | up | |
| 3/48 | | 40 | up | down | |
| 3/52 | | 40 | up | down | |
| 3/56 | 0/56 | 40 | up | up | |
| 3/60 | 0/60 | 40 | up | up | |

Locating an S4820T within a Stack

The S4820T has an LED which is used for the purpose of identifying a particular unit within a stack. This LED is located on the PSU side of the S4820T, and is called the “Location” LED. Use the **stack-unit location-led** command to control this LED:

```
FTOS#stack-unit 0 location-led ?
off      Stack unit location LED off
on       Stack unit location LED on
```

Influence Management Unit Selection on an S-Series Stack

Stack Priority is the system variable that FTOS uses to determine which units in the stack will be the master and standby management units. If multiple units tie for highest priority, the unit with the highest MAC address prevails.

If management was determined by priority only, a change in management occurs when:

- the management unit is powered down or a failover occurs
- you disconnect the management unit from the stack

When the management unit fails, the unit disappears from the stack topology. At that time, the standby unit detects the communication loss and switches from the standby unit role to the management unit role in the stack. From the remaining units in the stack, the system selects a new standby unit based on the unit priority using the same algorithm used when the stack was initially created. When the failed unit recovers, it takes the next available role, usually that of a stack member.

| Task | Command Syntax | Command Mode |
|--|----------------------------|---------------|
| Influence the selection of the stack management units. The unit with the numerically highest priority is elected the master management unit, and the unit with the second highest priority is the standby unit. Default: 0 Range: 1-14 | stack-unit priority | CONFIGURATION |

Manage Redundancy on an S-Series Stack

| Task | Command Syntax | Command Mode |
|---|--|----------------|
| Reset the current management unit, and make the standby unit the new master unit. A new standby is elected. When the former stack master comes back online, it becomes a member unit. | redundancy force-failover stack-unit | EXEC Privilege |
| Prevent the stack master from rebooting after a failover. This command does not affect a forced failover, manual reset, or a stack-link disconnect. | redundancy disable-auto-reboot stack-unit | CONFIGURATION |
| Display redundancy information. | show redundancy | EXEC Privilege |

Reset a Unit on an S-Series Stack

You may reset any stack unit except for the master management unit ([Message 2](#)).

Message 2 Master Reset Disallowed

```
% Error: Reset of master unit is not allowed.
```

| Task | Command Syntax | Command Mode |
|---|--------------------------------|----------------|
| Reload a stack-unit | reset stack-unit | EXEC Privilege |
| Reload a member unit, from the unit itself | reset-self | EXEC Privilege |
| Reset a stack-unit when the unit is in a problem state. | reset stack-unit {hard} | EXEC Privilege |

Verifying a Stack Configuration

LED Status Indicators on an S4810 or S4820T Stack

The light of the LED status indicator on the front panel identifies the unit's role in the stack.

For the S4810, the following lists the stacking LED's status indications:



Note: On the S4810, the Stacking LED is located on the I/O side of the unit.

- Off indicates the unit is a stack member.
- Blinking Green indicates the unit is the stack standby.

- Solid Green indicates the unit is the stack master (management unit)

For the S4820T, the following lists the stacking LED's status indications:



Note: On the S4820T, the Stacking LED is located on the PSU side of the unit.

- Solid Blue indicates the unit is the stack master (management unit). If the S4820T is a standalone unit, it will display Solid Blue as well.
- Blinking Blue indicates the unit is the stack standby.
- Solid Green indicates the unit is a stack member.



Note: See [Locating an S4820T within a Stack](#) for information about using the S4820T's Location LED.

Display Status of Stacking Ports

To display the status of the stacking ports, including the topology:

| Task | Command Syntax | Command Mode |
|-----------------------------|--------------------------------|----------------|
| Display the stacking ports. | show system stack-ports | EXEC Privilege |

The following example shows four switches stacked together with two 40G links in a ring topology.

```
FTOS#show system stack-ports
Topology: Ring
Interface  Connection    Link Speed    Admin    Link    Trunk
          (Gb/s)         Status        Status   Group
-----
  1/48      7/56           40            up       up
  1/52      5/60           40            up       up
  2/56      6/52           40            up       up
  2/60      4/52           40            up       up
  3/48      7/52           40            up       up
  3/52      5/56           40            up       up
  4/52      6/48           40            up       up
  4/56      4/48           40            up       up
FTOS#
```

The following example shows the parameters for the management unit in the stack.

```
FTOS#show system stack-unit 1

-- Unit 1 --
Unit Type      : Management Unit
Status         : online
Next Boot      : online
Required Type  : S4810 - 52-port GE/TE/FG (SE)
Current Type   : S4810 - 52-port GE/TE/FG (SE)
Master priority : 0
Hardware Rev   : 3.0
Num Ports      : 64
```

```

Up Time           : 1 min, 14 sec
FTOS Version      : 4810-8-3-12-1447
Jumbo Capable     : yes
POE Capable       : no
Boot Flash        : 1.2.0.2
Memory Size       : 2147483648 bytes
Temperature       : 44C
Voltage           : ok
Serial Number     : H1DL104400018
Part Number       :                Rev
Vendor Id         :
Date Code         :
Country Code      :
Piece Part ID     : N/A
PPID Revision     : N/A
Service Tag       : N/A
Expr Svc Code     : N/A
Auto Reboot       : disabled
Burned In MAC     : 00:01:e8:8c:53:32
No Of MACs        : 3

```

```
-- Power Supplies --
```

| Unit | Bay | Status | Type | FanStatus |
|------|-----|--------|------|-----------|
| 1 | 0 | absent | | absent |
| 1 | 1 | up | AC | up |

```
-- Fan Status --
```

| Unit | Bay | TrayStatus | Fan0 | Speed | Fan1 | Speed |
|------|-----|------------|------|-------|------|-------|
| 1 | 0 | up | up | 7200 | up | 7200 |
| 1 | 1 | up | up | 7200 | up | 7440 |

Speed in RPM

The following example shows three switches stacked together in a daisy chain topology.

```
stack-2#show system stack-ports
```

```
Topology: Daisy chain
```

| Interface | Connection | Link Speed (Gb/s) | Admin Status | Link Status | Trunk Group |
|-----------|------------|----------------------|-----------------|----------------|----------------|
| 0/36 | 1/36 | 10 | up | up | |
| 0/37 | 1/37 | 10 | up | up | |
| 0/38 | 1/38 | 10 | up | up | |
| 0/39 | 1/39 | 10 | up | up | |
| 0/44 | 2/36 | 10 | up | up | |
| 0/45 | 2/37 | 10 | up | up | |
| 0/46 | 2/38 | 10 | up | up | |
| 0/47 | 2/39 | 10 | up | up | |
| 1/36 | 0/36 | 10 | up | up | |
| 1/37 | 0/37 | 10 | up | up | |
| 1/38 | 0/38 | 10 | up | up | |
| 1/39 | 0/39 | 10 | up | up | |
| 2/36 | 0/44 | 10 | up | up | |
| 2/37 | 0/45 | 10 | up | up | |
| 2/38 | 0/46 | 10 | up | up | |
| 2/39 | 0/47 | 10 | up | up | |

```
stack-2#
```

Removing Units or Front End Ports from a Stack

- [Remove a Unit from an S-Series Stack](#)
- [Remove Front End Port Stacking](#)

Remove a Unit from an S-Series Stack

The running-configuration and startup-configuration are synchronized on all stack units. A stack member that is disconnected from the stack maintains this configuration.

To remove a stack member from the stack, disconnect the stacking cables from the unit. You may do this at any time, whether the unit is powered or unpowered, online or offline. Note that if you remove a unit in the middle of the daisy chain stack, the stack will be split into multiple parts and each will form a new stack according to the stacking algorithm described throughout this chapter.

Figure 46-11. Removing an S4810 or S4820T Stack Member—Before

```
Force10#show system brief

Stack MAC : 00:01:e8:8a:df:e6

Reload Type : normal-reload

-- Stack Info --
Unit  UnitType      Status      ReqTyp      CurTyp      Version      Ports
-----
  0    Management    online      S4810       S4810       8-3-7-13     64
  1    Member         online      S4810       S4810       8-3-7-13     64
  2    Member         not present
  3    Standby        online      S4810       S4810       8-3-7-13     64
```

Figure 46-12. Removing an S4810 or S4820T Stack Member—After

```
Force10#show system brief

Stack MAC : 00:01:e8:8a:df:e6

Reload Type : normal-reload

-- Stack Info --
Unit  UnitType      Status      ReqTyp      CurTyp      Version      Ports
-----
  0    Management    online      S4810       S4810       8-3-7-13     64
  1    Member         not present
  2    Member         not present
  3    Standby        online      S4810       S4810       8-3-7-13     64
  4    Member         not present
  5    Member         not present
  6    Member         not present
  7    Member         not present
  8    Member         not present
  9    Member         not present
 10    Member         not present
 11    Member         not present
```

Remove Front End Port Stacking

To remove the configuration on the front end ports used for stacking, use the following procedure.

| Task | Command Syntax | Command Mode |
|---|--|----------------|
| Remove the stack group configuration that are configured. | no stack-unit <i>id</i> stack-group <i>id</i> | CONFIGURATION |
| Save the stacking configuration on the ports. | write memory | EXEC Privilege |
| Reload the switch. | reload | EXEC Privilege |

After the units are reloaded, the system reboots. The units come up as standalone units after the reboot completes.

Troubleshoot an S-Series Stack

- [Recover from Stack Link Flaps](#)
- [Recover from a Card Problem State on an S-Series Stack](#)
- [Recover from a Card Mismatch State on an S-Series Stack](#)

Recover from Stack Link Flaps

S-Series Stack Link Integrity Monitoring enables units to monitor their own stack ports and disable any stack port that flaps five times within 10 seconds. FTOS displays console messages the local and remote members of a flapping link, and on the primary (master) and standby management units as KERN-2-INT messages if the flapping port belongs to either of these units.

In the following example, a stack-port on the master flaps. The remote member, Member 2, displays a console message, and the master and standby display KERN-2-INT messages.

To re-enable the downed stack-port, power cycle the offending unit.

```
-----MANAGEMENT UNIT-----
Error: Stack Port 50 has flapped 5 times within 10 seconds. Shutting down this stack port now.
Error: Please check the stack cable/module and power-cycle the stack.
10:55:20: %STKUNIT1-M:CP %KERN-2-INT: Error: Stack Port 50 has flapped 5 times within 10 seconds. Shutting down this stack port now.
10:55:20: %STKUNIT1-M:CP %KERN-2-INT: Error: Please check the stack cable/module and power-cycle the stack.
-----STANDBY UNIT-----
10:55:18: %STKUNIT1-M:CP %KERN-2-INT: Error: Stack Port 50 has flapped 5 times within 10 seconds. Shutting down this stack port now.
10:55:18: %STKUNIT1-M:CP %KERN-2-INT: Error: Please check the stack cable/module and power-cycle the stack.
-----MEMBER 2-----
Error: Stack Port 51 has flapped 5 times within 10 seconds. Shutting down this stack port now.
Error: Please check the stack cable/module and power-cycle the stack.
```

Recover from a Card Problem State on an S-Series Stack

If a unit added to a stack has a different FTOS version, the unit does not come online and FTOS cites a card problem error, as shown in [Figure 46-13](#). To recover, disconnect the new unit from the stack, change the FTOS version to match the stack, and then reconnect it to the stack, as shown in [Figure 46-14](#).

Figure 46-13. Card Problem Error on an S-Series Stack - Different FTOS Versions

```
stack-1#show system brief

Stack MAC : 00:01:e8:8a:fd:6e

Reload Type : normal-reload [Next boot : normal-reload]

-- Stack Info --
Unit  UnitType      Status           ReqTyp          CurTyp          Version         Ports
-----
  0    Standby      card problem    S4810           unknown         8-3-10-223     64
  1    Management    online         S4810           S4810           8-3-10-223     64
  2    Member        not present
  3    Member        not present
  4    Member        not present
  5    Member        not present
  6    Member        not present
  7    Member        not present
  8    Member        not present
  9    Member        not present
 10    Member        not present
 11    Member        not present

-- Power Supplies --
Unit  Bay  Status      Type  FanStatus
-----
  0    0    down        DC    down
  0    1    up          DC    up
  1    0    absent      AC    absent
  1    1    up          AC    up

-- Fan Status --
Unit Bay  TrayStatus  Fan0  Speed  Fan1  Speed
-----
  0    0    up          up    9360  up    9360
  0    1    up          up    9600  up    9360
  1    0    up          up    6720  up    6720
  1    1    up          up    6960  up    6720

Speed in RPM

stack-1#
```

Figure 46-14. Card Problem Error on an S-Series Stack - Different FTOS Versions

```
stack-1#show system brief

Stack MAC : 00:01:e8:8a:fd:6e

Reload Type : normal-reload [Next boot : normal-reload]

-- Stack Info --
Unit  UnitType      Status           ReqTyp          CurTyp          Version         Ports
-----
  0    Standby      online          S4810           S4810           8-3-10-223     64
  1    Management    online         S4810           S4810           8-3-10-223     64
```

```

2 Member not present
3 Member not present
4 Member not present
5 Member not present
6 Member not present
7 Member not present
8 Member not present
9 Member not present
10 Member not present
11 Member not present

```

```
-- Power Supplies --
```

| Unit | Bay | Status | Type | FanStatus |
|------|-----|--------|------|-----------|
| 0 | 0 | down | DC | down |
| 0 | 1 | up | DC | up |
| 1 | 0 | absent | | absent |
| 1 | 1 | up | AC | up |

```
-- Fan Status --
```

| Unit | Bay | TrayStatus | Fan0 | Speed | Fan1 | Speed |
|------|-----|------------|------|-------|------|-------|
| 0 | 0 | up | up | 6960 | up | 6720 |
| 0 | 1 | up | up | 6720 | up | 6720 |
| 1 | 0 | up | up | 6960 | up | 6720 |
| 1 | 1 | up | up | 6720 | up | 6720 |

Speed in RPM

stack-1#

Recover from a Card Mismatch State on an S-Series Stack

A card mismatch occurs if the stack has a provision for the lowest available stack number which does not match the model of a newly added unit. See the following example. To recover, disconnect the new unit. Then, either:

- remove the provision from the stack, then reconnect the standalone unit, or
- renumber the standalone unit with another available stack number on the stack.

Figure 46-15. Recovering from a Card Mismatch State on an S-Series Stack (S50N and S25N)

```

-----STANDALONE UNIT BEFORE-----
Standalone#show system brief
Stack MAC : 00:01:e8:d5:ef:81
-- Stack Info --
Unit  UnitType   Status      ReqTyp      CurTyp      Version     Ports
-----
  0  Management  online      S50V        S50V        7.8.1.0     52
  1  Member      not present S50N
  2  Member      not present S50V
  3  Member      not present S50V
  4  Member      not present
  5  Member      not present
  6  Member      not present
  7  Member      not present
-----STACK BEFORE-----
Stack#show system brief
Stack MAC : 00:01:e8:d5:f9:6f
-- Stack Info --

```

| Unit | UnitType | Status | ReqTyp | CurTyp | Version | Ports |
|------|---------------|--------------------|-------------|--------|---------|-------|
| 0 | Member | not present | S25N | | | |
| 1 | Management | online | S50N | S50N | 7.8.1.0 | 52 |
| 2 | Standby | online | S50V | S50V | 7.8.1.0 | 52 |
| 3 | Member | not present | | | | |
| 4 | Member | not present | | | | |
| 5 | Member | not present | | | | |
| 6 | Member | not present | | | | |
| 7 | Member | not present | | | | |

-----STANDALONE UNIT AFTER-----

01:38:34: %STKUNIT0-M:CP %POLLGR-2-ALT_STACK_UNIT_STATE: Alternate Stack-unit is present

01:38:34: %STKUNIT0-M:CP %CHMGR-5-STACKUNITDETECTED: Stack unit 1 present

Going for reboot. Reason is Stack merge

01:38:34: %STKUNIT0-M:CP %CHMGR-5-STACKUNITDETECTED: Stack unit 2 present

-----STACK AFTER-----

23:11:25: %STKUNIT1-M:CP %CHMGR-5-STACKUNITDETECTED: Stack unit 0 present

23:11:40: %STKUNIT1-M:CP %CHMGR-2-STACKUNIT_DOWN: Stack unit 0 down - card removed

23:12:25: %STKUNIT1-M:CP %CHMGR-5-STACKUNITDETECTED: Stack unit 0 present

23:12:34: %STKUNIT1-M:CP %CHMGR-5-CHECKIN: Checkin from Stack unit 0 (type S50V, 52 ports)

23:12:34: %STKUNIT1-M:CP %CHMGR-3-STACKUNIT_MISMATCH: Mismatch: Stack unit 0 is type S50V - type S25N required

Stack#show system brief

Stack MAC : 00:01:e8:d5:f9:6f

-- Stack Info --

| Unit | UnitType | Status | ReqTyp | CurTyp | Version | Ports |
|------|---------------|----------------------|-------------|-------------|---------|-------|
| 0 | Member | type mismatch | S25N | S50V | 7.8.1.0 | 52 |
| 1 | Management | online | S50N | S50N | 7.8.1.0 | 52 |
| 2 | Standby | online | S50V | S50V | 7.8.1.0 | 52 |
| 3 | Member | not present | | | | |
| 4 | Member | not present | | | | |
| 5 | Member | not present | | | | |
| 6 | Member | not present | | | | |
| 7 | Member | not present | | | | |

Storm Control

Storm Control is supported on platforms: e C S **S4810** **S4820T**

Storm Control for Multicast is supported on platforms: C S

The storm control feature enables you to control unknown-unicast and broadcast traffic on Layer 2 and Layer 3 physical interfaces.

FTOS Behavior: On the E-Series, FTOS supports broadcast control for Layer 3 traffic only. To control Layer 2 broadcast traffic use the command storm-control unknown-unicast. On the C-Series and S-Series, FTOS supports broadcast control (command storm-control broadcast) for Layer 2 *and* Layer 3 traffic.

FTOS Behavior: On E-Series, bi-directional traffic (unknown unicast and broadcast) along with egress storm control causes the configured traffic rates to be split between the involved ports. The percentage of traffic that each port receives after the split is not predictable. These ports can be in the same/different port-pipes or on the same/different line cards.

FTOS Behavior: The minimum number of packets per second (PPS) that storm control can limit on the S4810 and S4820T is 2.

Configure Storm Control

Storm control is supported in INTERFACE mode and CONFIGURATION mode

Configure storm control from INTERFACE mode

Configure storm control from INTERFACE mode using the command storm control. From INTERFACE mode:

- You can only on configure storm control for ingress traffic.
- If you configure storm control from both INTERFACE and CONFIGURATION mode, the INTERFACE mode configurations override the CONFIGURATION mode configurations.
- The percentage of storm control is calculated based on the advertised rate of the line card, not by the speed setting.

Configure storm control from CONFIGURATION mode

Configure storm control from CONFIGURATION mode using the command storm control. From CONFIGURATION mode you can configure storm control for ingress and egress traffic.

Do not apply per-VLAN QoS on an interface that has storm-control enabled (either on an interface or globally)

- On the E-Series, when broadcast storm-control is enabled on an interface or globally on the ingress and DSCP marking for a DSCP value 1 is configured for the data traffic, the traffic goes to queue 1 instead of queue 0. Similarly, if unicast storm-control is enabled on an interface or globally on the ingress, and DSCP marking for a DSCP value 2 is configured for the data traffic, the traffic goes to queue 2 instead of queue 0.

Spanning Tree Protocol (STP)

Spanning Tree Protocol (STP) is supported on platforms: [E](#) [C](#) [S](#) [S4810](#) [S4820T](#)

Protocol Overview

Spanning Tree Protocol (STP) is a Layer 2 protocol—specified by IEEE 802.1d—that eliminates loops in a bridged topology by enabling only a single path through the network. By eliminating loops, the protocol improves scalability in a large network and enables you to implement redundant paths, which can be activated upon the failure of active paths. Layer 2 loops, which can occur in a network due to poor network design and without enabling protocols like xSTP, can cause unnecessarily high switch CPU utilization and memory consumption.

FTOS supports three other variations of Spanning Tree, as shown here:

Table 48-1. FTOS Supported Spanning Tree Protocols

| Dell Force10 Term | IEEE Specification |
|--|--------------------|
| Spanning Tree Protocol (STP) | 802.1d |
| Rapid Spanning Tree Protocol (RSTP) | 802.1w |
| Multiple Spanning Tree Protocol (MSTP) | 802.1s |
| Per-VLAN Spanning Tree Plus (PVST+) | Third Party |

Configuring Spanning Tree

Configuring Spanning Tree is a two-step process:

1. [Configuring Interfaces for Layer 2 Mode.](#)
2. [Enabling Spanning Tree Protocol Globally.](#)

Related Configuration Tasks

- [Adding an Interface to the Spanning Tree Group](#)

- Removing an Interface from the Spanning Tree Group
- Modifying Global Parameters
- Modifying Interface STP Parameters
- Enabling PortFast
- Preventing Network Disruptions with BPDU Guard
- STP Root Selection
- SNMP Traps for Root Elections and Topology Changes
- Configuring Spanning Trees as Hitless

Important Points to Remember

- Spanning Tree Protocol (STP) is disabled by default.
- FTOS supports only one Spanning Tree instance (0). For multiple instances, you must enable MSTP, or PVST+. You may only enable one flavor of Spanning Tree at any one time.
- All ports in VLANs and all enabled interfaces in Layer 2 mode are automatically added to the Spanning Tree topology at the time you enable the protocol.
- To add interfaces to the Spanning Tree topology after STP is enabled, enable the port and configure it for Layer 2 using the command `switchport`.
- The IEEE Standard 802.1D allows eight bits for port ID and eight bits for priority. However, the eight bits for port ID provide port IDs for only 256 ports and the C-Series can contain 336 ports. To accommodate the increased number of ports, FTOS uses four bits from priority field in the port ID field. This implementation affects the Bridge MIB (RFC 1493), and you must interpret objects such as *dot1dStpPortDesignatedPort* object by using the first four bits as the priority and the last 12 bits as the port ID.

Configuring Interfaces for Layer 2 Mode

All interfaces on all switches that will participate in Spanning Tree must be in Layer 2 mode and enabled.

Figure 48-1. Example of Configuring Interfaces for Layer 2 Mode

```

R1(conf)# int range gi 1/1 - 4
R1(conf-if-gi-1/1-4)# switchport
R1(conf-if-gi-1/1-4)# no shutdown
R1(conf-if-gi-1/1-4)#show config
!
interface GigabitEthernet 1/1
 no ip address
 switchport
 no shutdown
!
interface GigabitEthernet 1/2
 no ip address
 switchport
 no shutdown
!
interface GigabitEthernet 1/3
 no ip address
 switchport
 no shutdown
!
interface GigabitEthernet 1/4
 no ip address
 switchport
 no shutdown

```

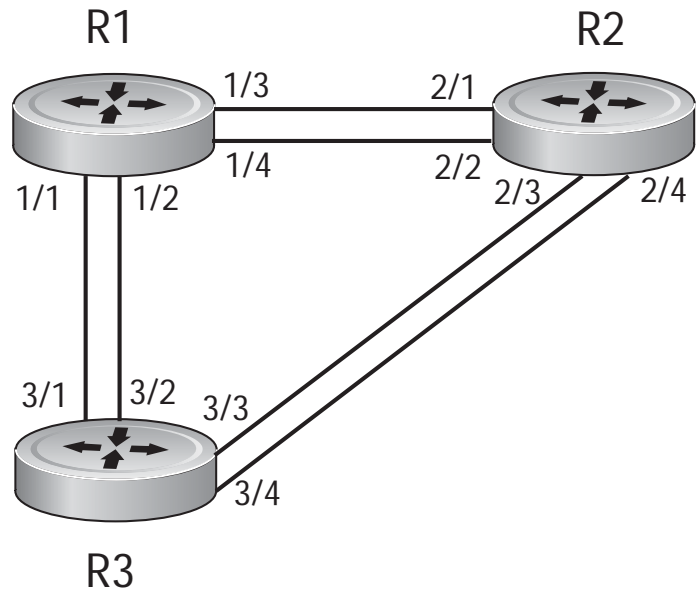

To configure the interfaces for Layer 2 and then enable them:

| Step | Task | Command Syntax | Command Mode |
|------|--|----------------|--------------|
| 1 | If the interface has been assigned an IP address, remove it. | no ip address | INTERFACE |
| 2 | Place the interface in Layer 2 mode. | switchport | INTERFACE |
| 3 | Enable the interface. | no shutdown | INTERFACE |

Verify that an interface is in Layer 2 mode and enabled using the show config command from INTERFACE mode.

```

FTOS(conf-if-gi-1/1)#show config
!
interface GigabitEthernet 1/1
 no ip address
 switchport
 no shutdown
FTOS(conf-if-gi-1/1)#

```

Enabling Spanning Tree Protocol Globally

Spanning Tree Protocol must be enabled globally; it is not enabled by default.

To enable Spanning Tree globally for all Layer 2 interfaces:

| Step | Task | Command Syntax | Command Mode |
|------|--|--------------------------|------------------------|
| 1 | Enter the PROTOCOL SPANNING TREE mode. | protocol spanning-tree 0 | CONFIGURATION |
| 2 | Enable Spanning Tree. | no disable | PROTOCOL SPANNING TREE |



Note: To disable STP globally for all Layer 2 interfaces, enter the disable command from PROTOCOL SPANNING TREE mode.

Verify that Spanning Tree is enabled using the show config command from PROTOCOL SPANNING TREE mode.

```
FTOS(conf)#protocol spanning-tree 0
FTOS(config-span)#show config
!
protocol spanning-tree 0
  no disable
FTOS#
```

When you enable Spanning Tree, all physical, VLAN, and port-channel interfaces that are enabled and in Layer 2 mode are automatically part of the Spanning Tree topology.

- Only one path from any bridge to any other bridge participating in STP is enabled.
- Bridges block a redundant path by disabling one of the link ports.

Figure 48-2. Spanning Tree Enabled Globally

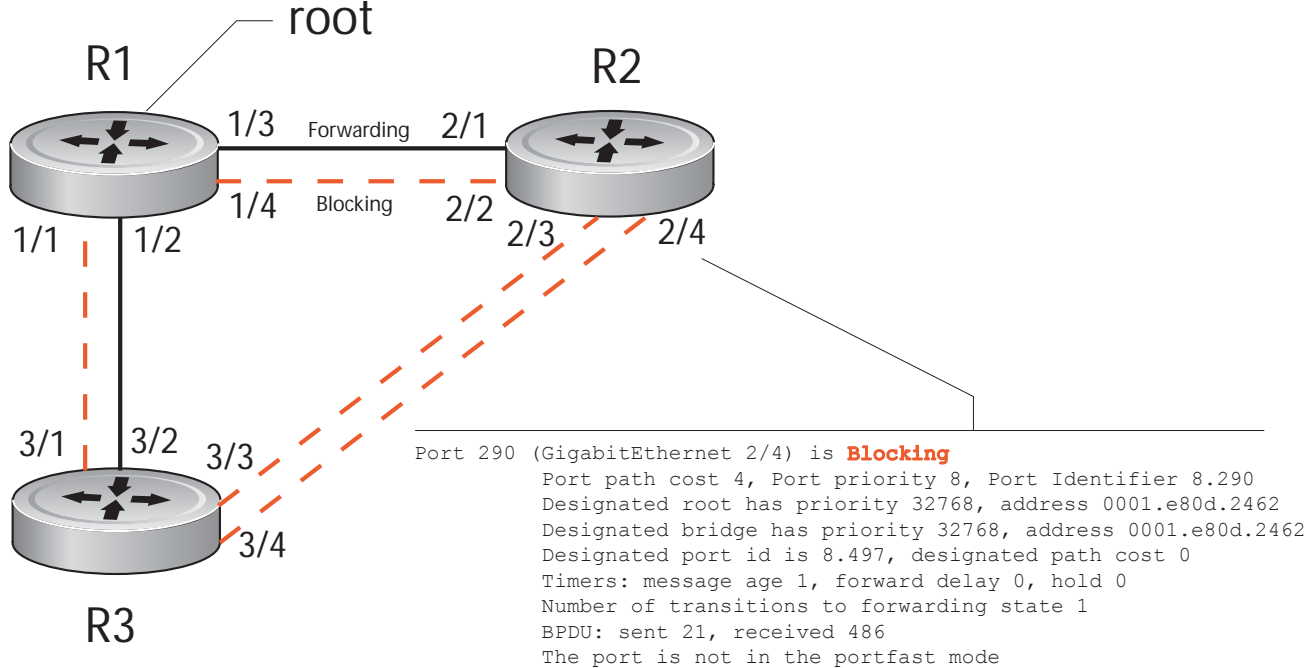

View the Spanning Tree configuration and the interfaces that are participating in STP using the `show spanning-tree 0` command from EXEC privilege mode. If a physical interface is part of a port channel, only the port channel is listed in the command output.

```
R2#show spanning-tree 0
  Executing IEEE compatible Spanning Tree Protocol
    Bridge Identifier has priority 32768, address 0001.e826.ddb7
    Configured hello time 2, max age 20, forward delay 15
    Current root has priority 32768, address 0001.e80d.2462
    Root Port is 289 (GigabitEthernet 2/1), cost of root path is 4
    Topology change flag not set, detected flag not set
    Number of topology changes 3 last change occurred 0:16:11 ago
      from GigabitEthernet 2/3
    Timers: hold 1, topology change 35
             hello 2, max age 20, forward delay 15
    Times:  hello 0, topology change 0, notification 0, aging Normal

Port 289 (GigabitEthernet 2/1) is Forwarding
Port path cost 4, Port priority 8, Port Identifier 8.289
Designated root has priority 32768, address 0001.e80d.2462
Designated bridge has priority 32768, address 0001.e80d.2462
Designated port id is 8.496, designated path cost 0
Timers: message age 1, forward delay 0, hold 0
Number of transitions to forwarding state 1
BPDU: sent 21, received 486
The port is not in the portfast mode

Port 290 (GigabitEthernet 2/2) is Blocking
Port path cost 4, Port priority 8, Port Identifier 8.290
--More--
Timers: message age 1, forward delay 0, hold 0
Number of transitions to forwarding state 1
BPDU: sent 21, received 486
The port is not in the portfast mode
```

Confirm that a port is participating in Spanning Tree using the show spanning-tree 0 brief command from EXEC privilege mode.

```
FTOS#show spanning-tree 0 brief
  Executing IEEE compatible Spanning Tree Protocol
    Root ID Priority 32768, Address 0001.e80d.2462
    We are the root of the spanning tree
    Root Bridge hello time 2, max age 20, forward delay 15
    Bridge ID Priority 32768, Address 0001.e80d.2462
    Configured hello time 2, max age 20, forward delay 15

Interface
  Name          PortID Prio Cost Sts Cost      Designated
  -----
  Gi 1/1        8.496  8    4 DIS  0    32768 0001.e80d.2462 8.496
  Gi 1/2        8.497  8    4 DIS  0    32768 0001.e80d.2462 8.497
  Gi 1/3        8.513  8    4 FWD  0    32768 0001.e80d.2462 8.513
  Gi 1/4        8.514  8    4 FWD  0    32768 0001.e80d.2462 8.514
FTOS#
```

Adding an Interface to the Spanning Tree Group

To add a Layer 2 interface to the Spanning Tree topology:

| Task | Command Syntax | Command Mode |
|--|-----------------|--------------|
| Enable Spanning Tree on a Layer 2 interface. | spanning-tree 0 | INTERFACE |

Removing an Interface from the Spanning Tree Group

To remove a Layer 2 interface from the Spanning Tree topology:

| Task | Command Syntax | Command Mode |
|---|--------------------|--------------|
| Disable Spanning Tree on a Layer 2 interface. | no spanning-tree 0 | INTERFACE |

FTOS Behavior: In FTOS versions prior to 7.6.1.0, the command no spanning tree disables Spanning Tree on the interface, however, BPDUs are still forwarded to the RPM, where they are dropped. Beginning in FTOS version 7.6.1.0, the command no spanning tree disables Spanning Tree on the interface, and incoming BPDUs are dropped at the line card instead of at the RPM, which frees processing resources. This behavior is called Layer 2 BPDU filtering and is available for STP, RSTP, PVST+, and MSTP.

Modifying Global Parameters

You can modify Spanning Tree parameters. The root bridge sets the values for forward-delay, hello-time, and max-age and overwrites the values set on other bridges participating in Spanning Tree.



Note: Dell Force10 recommends that only experienced network administrators change the Spanning Tree parameters. Poorly planned modification of the Spanning Tree parameters can negatively impact network performance.

Table 48-2 displays the default values for Spanning Tree.

Table 48-2. STP Default Values

| STP Parameter | | Default Value |
|---------------|--|---------------|
| Forward Delay | | 15 seconds |
| Hello Time | | 2 seconds |
| Max Age | | 20 seconds |
| Port Cost | 100-Mb/s Ethernet interfaces | 19 |
| | 1-Gigabit Ethernet interfaces | 4 |
| | 10-Gigabit Ethernet interfaces | 2 |
| | Port Channel with 100 Mb/s Ethernet interfaces | 18 |
| | Port Channel with 1-Gigabit Ethernet interfaces | 3 |
| | Port Channel with 10-Gigabit Ethernet interfaces | 1 |
| Port Priority | | 8 |

To change STP global parameters:

| Task | Command Syntax | Command Mode |
|---|---|---------------------------|
| Change the forward-delay parameter (the wait time before the interface enters the <i>forwarding</i> state). <ul style="list-style-type: none"> Range: 4 to 30 Default: 15 seconds | <code>forward-delay <i>seconds</i></code> | PROTOCOL SPANNING TREE |
| Change the hello-time parameter (the BPDU transmission interval). <p>Note: With large configurations (especially those with more ports) Dell Force10 recommends that you increase the hello-time.</p> Range: 1 to 10 Default: 2 seconds | <code>hello-time <i>seconds</i></code> | PROTOCOL SPANNING TREE |
| Change the max-age parameter (the refresh interval for configuration information that is generated by recomputing the Spanning Tree topology). Range: 6 to 40 Default: 20 seconds | <code>max-age <i>seconds</i></code> | PROTOCOL SPANNING TREE |

View the current values for global parameters using the `show spanning-tree 0` command from EXEC privilege mode. Refer to the second example in [Enabling Spanning Tree Protocol Globally](#).

Modifying Interface STP Parameters

You can set the port cost and port priority values of interfaces in Layer 2 mode.

- **Port cost** is a value that is based on the interface type. The greater the port cost, the less likely the port will be selected to be a forwarding port.
- **Port priority** influences the likelihood that a port will be selected to be a forwarding port in case that several ports have the same port cost.

The default values are listed in [Table 48-2](#).

To change the port cost or priority of an interface:

| Task | Command Syntax | Command Mode |
|---|--|--------------|
| Change the port cost of an interface. Range: 0 to 65535 Default: see Table 48-2 . | <code>spanning-tree 0 cost cost</code> | INTERFACE |
| Change the port priority of an interface. Range: 0 to 15 Default: 8 | <code>spanning-tree 0 priority priority-value</code> | INTERFACE |

View the current values for interface parameters using the `show spanning-tree 0` command from EXEC privilege mode. Refer to the second example in [Enabling Spanning Tree Protocol Globally](#).

Enabling PortFast

The PortFast feature enables interfaces to begin forwarding traffic approximately 30 seconds sooner. Interfaces forward frames by default until they receive a BPDU that indicates that they should behave otherwise; they do not go through the Learning and Listening states. The `bpduguard shutdown-on-violation` option causes the interface hardware to be shutdown when it receives a BPDU. When only `bpduguard` is implemented, although the interface is placed in an Error Disabled state when receiving the BPDU, the physical interface remains up and spanning-tree will drop packets in the hardware after a BPDU violation. BPDUs are dropped in the software after receiving the BPDU violation.



Caution: Enable PortFast only on links connecting to an end station. PortFast can cause loops if it is enabled on an interface connected to a network.

To enable PortFast on an interface:

| Task | Command Syntax | Command Mode |
|----------------------------------|--|--------------|
| Enable PortFast on an interface. | <code>spanning-tree stp-id portfast [bpduguard [shutdown-on-violation]]</code> | INTERFACE |

Verify that PortFast is enabled on a port using the `show spanning-tree` command from the EXEC privilege mode or the `show config` command from INTERFACE mode; Dell Force10 recommends using the `show config` command, as shown in [Figure 48-3](#).

Figure 48-3. PortFast Enabled on Interface

```
FTOS#(conf-if-gi-1/1)#show conf
!
interface GigabitEthernet 1/1
  no ip address
  switchport
  spanning-tree 0 portfast
  no shutdown
FTOS#(conf-if-gi-1/1)#
```

Indicates that the interface is in PortFast mode

Preventing Network Disruptions with BPDU Guard

The Portfast (and Edgeport, in the case of RSTP, PVST+, and MSTP) feature should be configured on ports that connect to end stations. End stations do not generate BPDUs, so ports configured with Portfast/Edgeport (edgeports) do not expect to receive BPDUs. If an edgeport does receive a BPDU, it likely means that it is connected to another part of the network, which can negatively effect the STP topology. The BPDU Guard feature blocks an edgeport upon receiving a BPDU to prevent network disruptions, and FTOS displays [Message 1](#). Enable BPDU Guard using the option `bpduguard` when enabling PortFast or EdgePort. The `bpduguard shutdown-on-violation` option causes the interface hardware to be shutdown when it receives a BPDU. Otherwise, although the interface is placed in an Error Disabled state when receiving the BPDU, the physical interface remains up and spanning-tree will only drop *packets* after a BPDU violation.

[Figure 48-4](#) shows a scenario in which an edgeport might unintentionally receive a BPDU. The port on the Dell Force10 system is configured with Portfast. If the switch is connected to the hub, the BPDUs that the switch generates might trigger an undesirable topology change. If BPDU Guard is enabled, when the edge port receives the BPDU, the BPDU will be dropped, the port will be blocked, and a console message will be generated.

Message 1 BPDU Guard Error

```
3w3d0h: %RPM0-P:RP2 %SPANMGR-5-BPDU_GUARD_RX_ERROR: Received Spanning Tree BPDU on BPDU guard port. Disable GigabitEthernet 3/41.
```



Note: Unless the shutdown-on-violation option is enabled, spanning-tree only *drops packets* after a BPDU violation; the physical interface remains up, as shown below.

```
FTOS(conf-if-gi-0/7)#do show spanning-tree rstp brief
Executing IEEE compatible Spanning Tree Protocol
Root ID      Priority 32768, Address 0001.e805.fb07
Root Bridge hello time 2, max age 20, forward delay 15
Bridge ID    Priority 32768, Address 0001.e85d.0e90
Configured hello time 2, max age 20, forward delay 15
```

| Interface Name | PortID | Prio | Cost | Sts Cost | Designated Bridge ID | PortID |
|----------------|---------|------|-------|-----------|----------------------|---------|
| Gi 0/6 | 128.263 | 128 | 20000 | FWD 20000 | 32768 0001.e805.fb07 | 128.653 |
| Gi 0/7 | 128.264 | 128 | 20000 | EDS 20000 | 32768 0001.e85d.0e90 | 128.264 |

| Interface Name | Role | PortID | Prio | Cost | Sts Cost | Link-type | Edge |
|----------------|--------|---------|------|-------|-----------|-----------|------|
| Gi 0/6 | Root | 128.263 | 128 | 20000 | FWD 20000 | P2P | No |
| Gi 0/7 | ErrDis | 128.264 | 128 | 20000 | EDS 20000 | P2P | No |

```
FTOS(conf-if-gi-0/7)#do show ip int br gi 0/7
```

| Interface | IP-Address | OK | Method | Status | Protocol |
|---------------------|------------|-----|--------|--------|----------|
| GigabitEthernet 0/7 | unassigned | YES | Manual | up | up |

FTOS Behavior: Regarding bpduguard shutdown-on-violation behavior:

- 1 If the interface to be shutdown is a port channel then all the member ports are disabled in the hardware.
- 2 When a physical port is added to a port channel already in error disable state, the new member port will also be disabled in the hardware.
- 3 When a physical port is removed from a port channel in error disable state, the error disabled state is cleared on this physical port (the physical port will be enabled in the hardware).
- 4 The reset linecard command does not clear the error disabled state of the port or the hardware disabled state. The interface continues to be disabled in the hardware.

The error disabled state can be cleared with any of the following methods:

- Perform an shutdown command on the interface.
- Disable the shutdown-on-violation command on the interface (no spanning-tree *stp-id* portfast [bpduguard | [shutdown-on-violation]]).
- Disable spanning tree on the interface (no spanning-tree in INTERFACE mode).
- Disabling global spanning tree (no spanning-tree in CONFIGURATION mode).

Figure 48-4. Enabling BPDUGuard

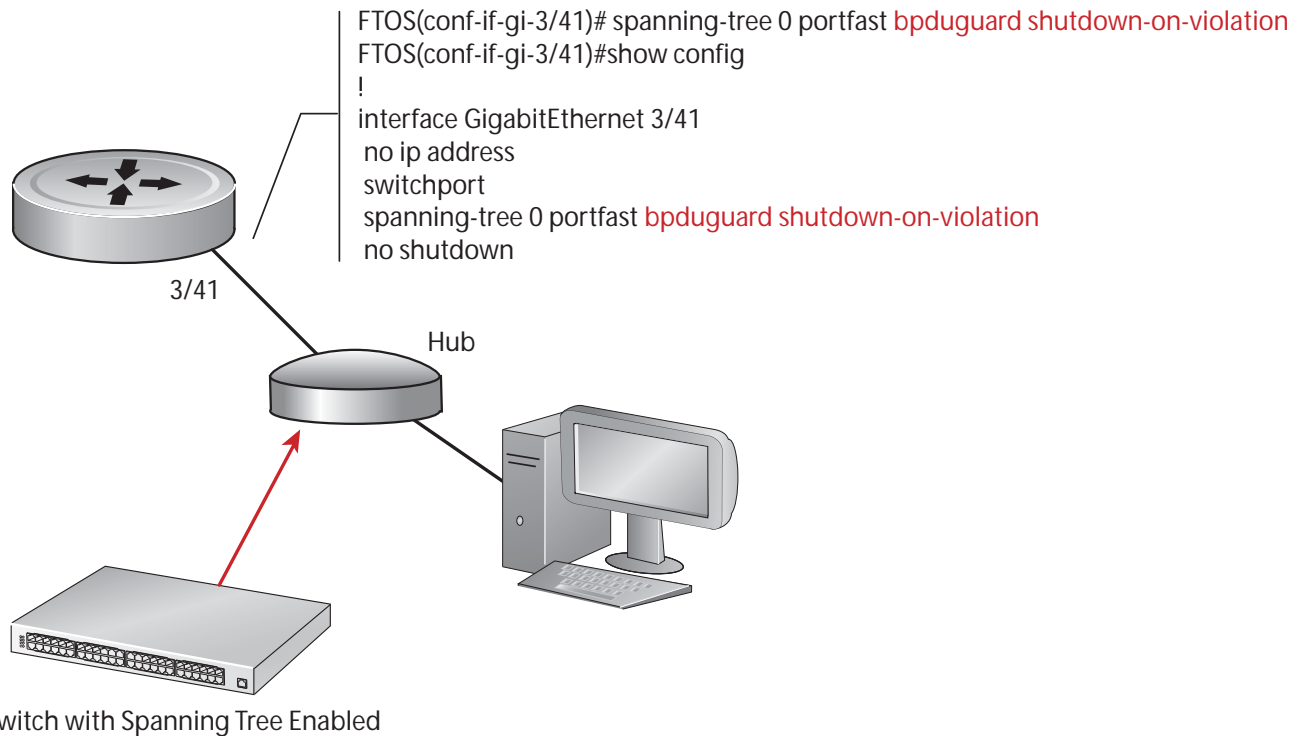

FTOS Behavior: BPDUGuard and BPDUGuard filtering (refer to [Removing an Interface from the Spanning Tree Group](#)) both block BPDUs, but are two separate features.

BPDUGuard:

- is used on edgeports and blocks all traffic on edgeport if it receives a BPDU
- drops the BPDU after it reaches the RPM and generates a console message

BPDUGuard Filtering:

- disables Spanning Tree on an interface
- drops all BPDUs at the line card without generating a console message

STP Root Selection

The Spanning Tree Protocol determines the root bridge, but you can assign one bridge a lower priority to increase the likelihood that it will be selected as the root bridge. You can also specify that a bridge is the root or the secondary root.

To change the bridge priority or specify that a bridge is the root or secondary root:

| Task | Command Syntax | Command Mode |
|---|--|---------------------------|
| Assign a number as the bridge priority or designate it as the root or secondary root. <i>priority-value</i> range: 0 to 65535. The lower the number assigned, the more likely this bridge will become the root bridge. The default is 32768. | bridge-priority { <i>priority-value</i> primary secondary} | PROTOCOL SPANNING TREE |
| <ul style="list-style-type: none"> The primary option specifies a bridge priority of 8192. The secondary option specifies a bridge priority of 16384. | | |

View only the root information using the show spanning-tree root command (see [Figure 48-5](#)) from EXEC privilege mode.

Figure 48-5. show spanning-tree root Command Example

```
FTOS#show spanning-tree 0 root
      Root ID  Priority 32768, Address 0001.e80d.2462
      We are the root of the spanning tree
      Root Bridge hello time 2, max age 20, forward delay 15
FTOS#
```

STP Root Guard

STP Root Guard is supported only on platforms: C e S **S4810** **S4820T**

Use the STP Root Guard feature in a Layer 2 network to avoid bridging loops. In STP, the switch in the network with the lowest priority (as determined by STP or set with the **bridge-priority** command) is selected as the root bridge. If two switches have the same priority, the switch with the lower MAC address is selected as the root. All other switches in the network use the root bridge as the reference used to calculate the shortest forwarding path.

Because any switch in an STP network with a lower priority can become the root bridge, the forwarding topology may not be stable. The location of the root bridge can change, resulting in unpredictable network behavior. The STP root guard feature ensures that the position of the root bridge does not change.

Root Guard Scenario

For example, in [Figure 48-6](#) (STP topology 1 upper left) Switch A is the root bridge in the network core. Switch C functions as an access switch connected to an external device. The link between Switch C and Switch B is in a blocking state. The flow of STP BPDUs is shown in the illustration.

In STP topology 2 ([Figure 48-6](#) upper right), STP is enabled on device D on which a software bridge application is started to connect to the network. Because the priority of the bridge in device D is lower than the root bridge in Switch A, device D is elected as root, causing the link between Switches A and B to enter a blocking state. Network traffic then begins to flow in the directions indicated by the BPDUs in the topology. If the links between Switches C and A or Switches C and B cannot handle the increased traffic flow, frames may be dropped.

In STP topology 3 (Figure 48-6 lower middle), if the root guard feature is enabled on the STP port on Switch C that connects to device D, and device D sends a superior BPDUs that would trigger the election of device D as the new root bridge, the BPDUs are ignored and the port on Switch C transitions from a forwarding to a root-inconsistent state (shown by the green X icon). As a result, Switch A becomes the root bridge.

All incoming and outgoing traffic is blocked on an STP port in a root-inconsistent state. After the timeout period, the Switch C port automatically transitions to a forwarding state as soon as device D stops sending BPDUs that advertise a lower priority.

If you enable a root guard on all STP ports on the links where the root bridge should not appear, you can ensure a stable STP network topology and avoid bridging loops.

Figure 48-6. STP Root Guard Prevents Bridging Loops

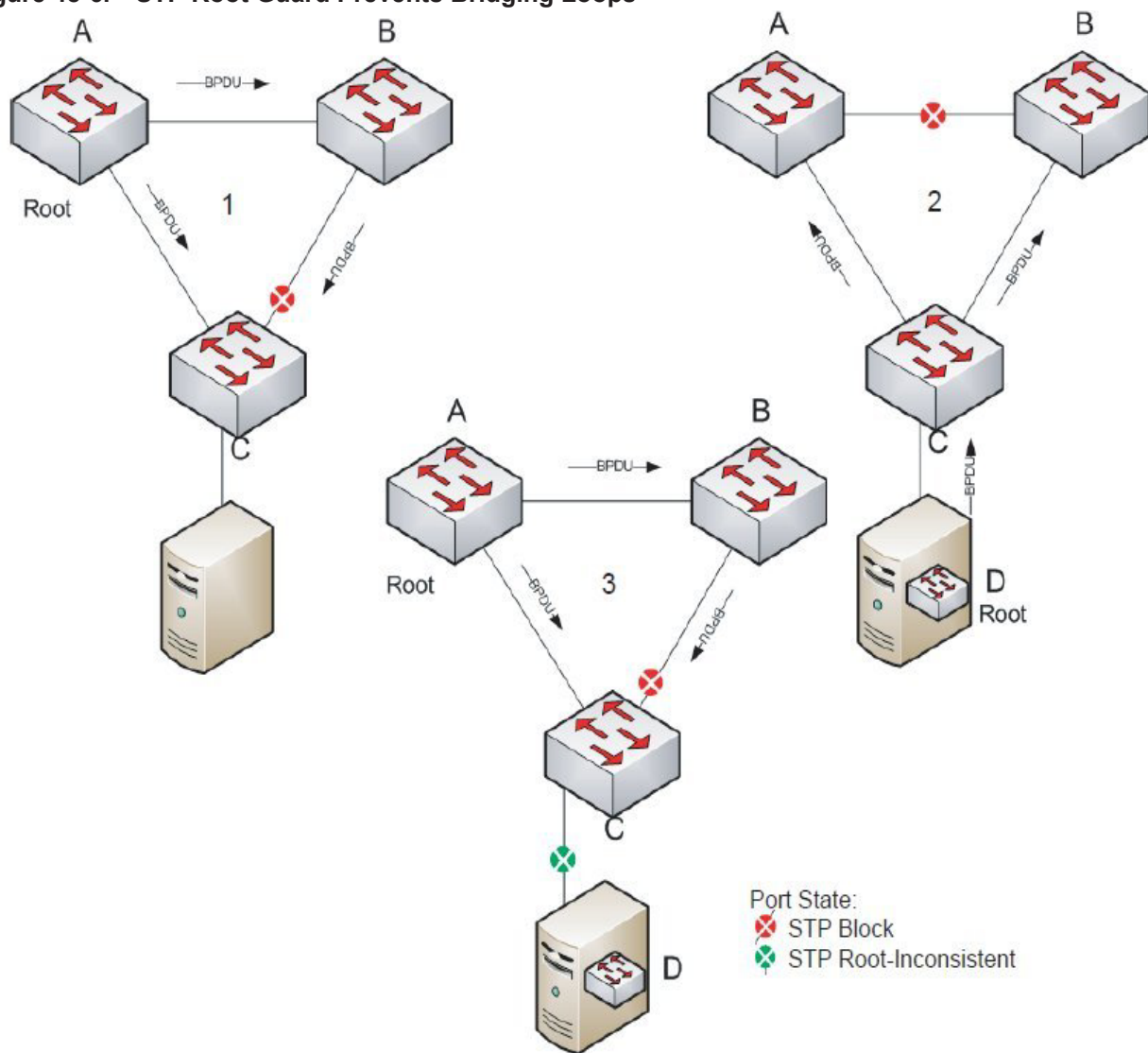

Root Guard Configuration

You enable STP root guard on a per-port or per-port-channel basis.

FTOS Behavior: The following conditions apply to a port enabled with STP root guard:

- Root guard is supported on any STP-enabled port or port-channel interface except when used as a stacking port.
- Root guard is supported on a port in any Spanning Tree mode:
 - Spanning Tree Protocol (STP)
 - Rapid Spanning Tree Protocol (RSTP)
 - Multiple Spanning Tree Protocol (MSTP)
 - Per-VLAN Spanning Tree Plus (PVST+)
- When enabled on a port, root guard applies to all VLANs configured on the port.
- Root guard and loop guard cannot be enabled at the same time on an STP port. For example, if you configure root guard on a port on which loop guard is already configured, the following error message is displayed:
- % Error: LoopGuard is configured. Cannot configure RootGuard.
- When used in an MSTP network, if root guard blocks a boundary port in the CIST, the port is also blocked in all other MST instances.

To enable the root guard on an STP-enabled port or port-channel interface in instance 0, enter the **spanning-tree 0 rootguard** command:

| Task | Command Syntax | Command Mode |
|---|---|--------------|
| Enable root guard on a port or port-channel interface. | spanning-tree {0 mstp rstp | INTERFACE |
| 0: Enables root guard on an STP-enabled port assigned to instance 0. | pvst} rootguard | INTERFACE |
| mstp: Enables root guard on an MSTP-enabled port. | | PORT-CHANNEL |
| rstp: Enables root guard on an RSTP-enabled port. | | |
| pvst: Enables root guard on a PVST-enabled port. | | |

To disable STP root guard on a port or port-channel interface, enter the **no spanning-tree 0 rootguard** command in an interface configuration mode.

To verify the STP root guard configuration on a port or port-channel interface, enter the **show spanning-tree 0 guard [interface interface]** command in global configuration mode.

SNMP Traps for Root Elections and Topology Changes

- Enable SNMP traps for Spanning Tree state changes using the command **snmp-server enable traps stp**.
- Enable SNMP traps for RSTP, MSTP, and PVST+ collectively using the command **snmp-server enable traps xstp**.

Configuring Spanning Trees as Hitless

Configuring Spanning Trees as Hitless is supported only on platforms: C e **S4810** **S4820T**

You can configure Spanning Tree (STP), Rapid Spanning Tree (RSTP), Multiple Spanning Tree (MSTP), and Per-Vlan Spanning Tree (PVST+) to be hitless (all or none must be configured as hitless). When configured as hitless, critical protocol state information is synchronized between RPMs so that RPM failover is seamless and no topology change is triggered.

Configure LACP to be hitless using the command `redundancy protocol lacp`. Configure all Spanning Tree types to be hitless using the command `redundancy protocol xstp` from CONFIGURATION mode, as shown in Figure 48-7.

Figure 48-7. Configuring all Spanning Tree Types to be Hitless

```
FTOS (conf) #redundancy protocol xstp
FTOS#show running-config redundancy
!
redundancy protocol xstp
FTOS#
```

STP Loop Guard

STP Loop Guard is supported only on platforms: C e S **S4810** **S4820T**

Loop Guard Scenario

The STP Loop Guard feature provides protection against Layer 2 forwarding loops (STP loops) caused by a hardware failure, such as a cable failure or an interface fault. When a cable or interface fails, a participating STP link may become unidirectional (STP requires links to be bidirectional) and an STP port does not receive BPDUs. When an STP blocking port does not receive BPDUs, it transitions to a forwarding state. This condition can create a loop in the network.

For example, in Figure 48-8 (STP topology 1 - upper left), Switch A is the root switch and Switch B normally transmits BPDUs to Switch C. The link between Switch C and Switch B is in a blocking state. However, if there is a unidirectional link failure (STP topology 1 - lower left), Switch C does not receive BPDUs from Switch B. When the **max-age** timer expires, the STP port on Switch C becomes unblocked and transitions to forwarding state. A loop is created as both Switch A and Switch C transmit traffic to Switch B.

Note that in Figure 48-8 (STP topology 2 - upper right), a loop can also be created if the forwarding port on Switch B becomes busy and does not forward BPDUs within the configured **forward-delay** time. As a result, the blocking port on Switch C transitions to a forwarding state, and both Switch A and Switch C transmit traffic to Switch B (STP topology 2 - lower right).

As shown in STP topology 3 (Figure 48-8 bottom middle), after you enable loop guard on an STP port or port-channel on Switch C, if no BPDUs are received and the **max-age** timer expires, the port transitions from a blocked state to a loop-inconsistent state (instead of to a forwarding state). Loop guard blocks the STP port so that no traffic is transmitted and no loop is created.

As soon as a BPDU is received on an STP port in a loop-inconsistent state, the port returns to a blocking state. If you disable STP loop guard on a port in a loop-inconsistent state, the port transitions to an STP blocking state and restarts the **max-age** timer.

Figure 48-8. STP Loop Guard Prevents Forwarding Loops

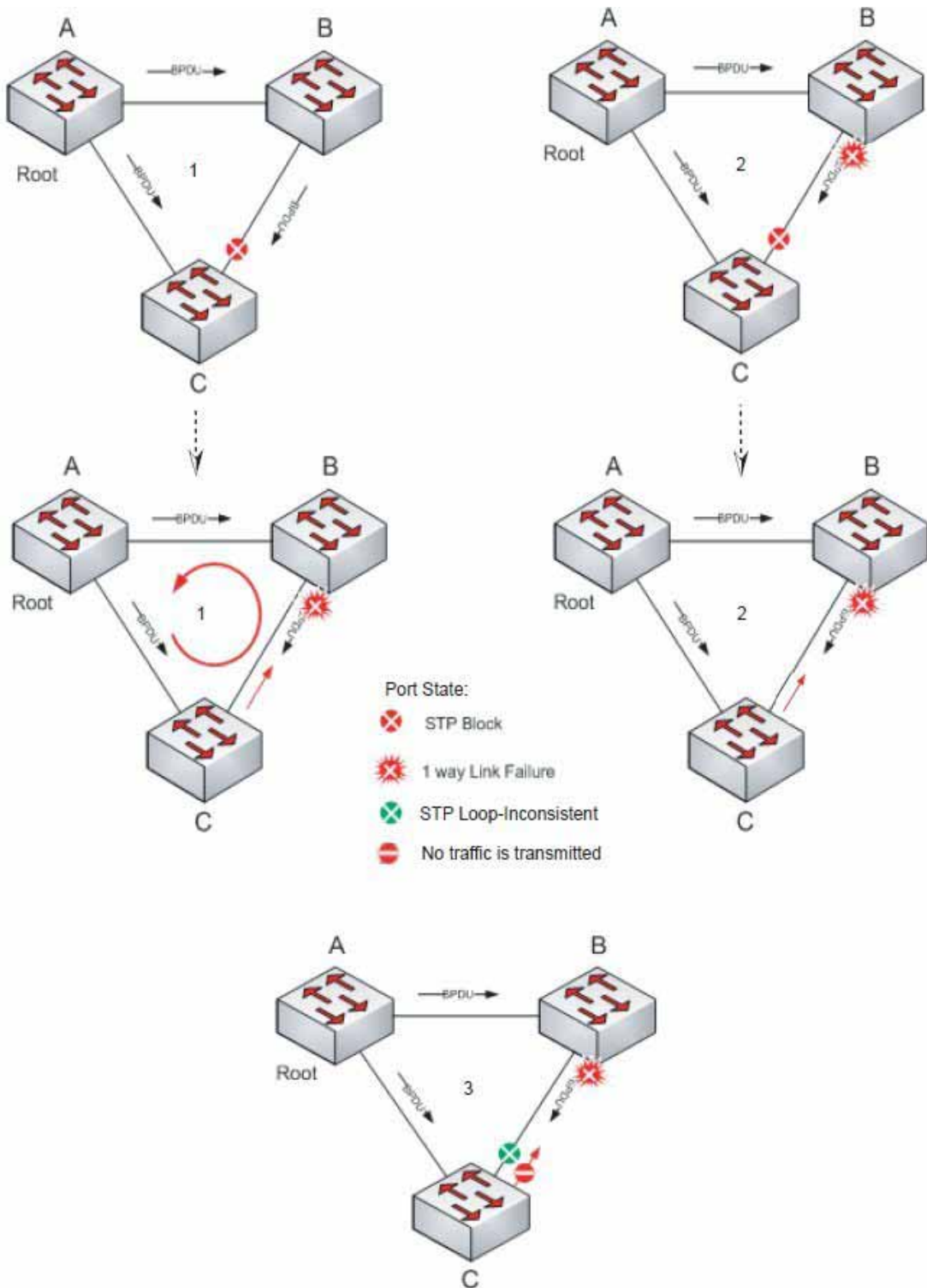

Loop Guard Configuration

You enable STP loop guard on a per-port or per-port channel basis.

FTOS Behavior: The following conditions apply to a port enabled with loop guard:

- Loop guard is supported on any STP-enabled port or port-channel interface.
- Loop guard is supported on a port or port-channel in any Spanning Tree mode:
 - Spanning Tree Protocol (STP)
 - Rapid Spanning Tree Protocol (RSTP)
 - Multiple Spanning Tree Protocol (MSTP)
 - Per-VLAN Spanning Tree Plus (PVST+)
- Root guard and loop guard cannot be enabled at the same time on an STP port. For example, if you configure loop guard on a port on which root guard is already configured, the following error message is displayed:
% Error: RootGuard is configured. Cannot configure LoopGuard.
- **C-Series and E-Series only:** Loop guard is supported on a C-Series or E-Series switch configured for hitless STP (see [Configuring Spanning Trees as Hitless](#)).
- Enabling Portfast BPDU guard and loop guard at the same time on a port results in a port that remains in a blocking state and prevents traffic from flowing through it. For example, when Portfast BPDU guard and loop guard are both configured:
 - If a BPDU is received from a remote device, BPDU guard places the port in an err-disabled blocking state and no traffic is forwarded on the port.
 - If no BPDU is received from a remote device, loop guard places the port in a loop-inconsistent blocking state and no traffic is forwarded on the port.
- When used in a PVST+ network, STP loop guard is performed per-port or per-port channel at a VLAN level. If no BPDUs are received on a VLAN interface, the port or port-channel transitions to a loop-inconsistent (blocking) state only for this VLAN.

To enable a loop guard on an STP-enabled port or port-channel interface, enter the **spanning-tree 0 loopguard** command:

| Task | Command Syntax | Command Mode |
|---|---|--------------|
| Enable loop guard on a port or port-channel interface. | spanning-tree {0 mstp rstp | INTERFACE |
| 0: Enables loop guard on an STP-enabled port assigned to instance 0. | pvst} loopguard | INTERFACE |
| mstp: Enables loop guard on an MSTP-enabled port. | | PORT-CHANNEL |
| rstp: Enables loop guard on an RSTP-enabled port. | | |
| pvst: Enables loop guard on a PVST-enabled port. | | |

To disable STP loop guard on a port or port-channel interface, enter the **no spanning-tree 0 loopguard** command in an INTERFACE configuration mode.

To verify the STP loop guard configuration on a port or port-channel interface, enter the **show spanning-tree 0 guard [interface interface]** command in global configuration mode.

Displaying STP Guard Configuration

To verify the STP guard configured on port or port-channel interfaces, enter the **show spanning-tree 0 guard [interface interface]** command.

The example below shows an STP network (instance 0) in which:

- Root guard is enabled on a port that is in a root-inconsistent state.
- Loop guard is enabled on a port that is in a listening state.
- BPDU guard is enabled on a port that is shut down (Error Disabled state) after receiving a BPDU.

```
FTOS#show spanning-tree 0 guard
Interface
Name          Instance   Sts          Guard type
-----
Gi 0/1        0          INCON(Root)  Rootguard
Gi 0/2        0          LIS          Loopguard
Gi 0/3        0          EDS (Shut)  Bpduguard
```

System Time and Date

System Time and Date settings, and Network Time Protocol are supported on platforms:

e c s **S4810** **S4820T**

System times and dates can be set and maintained through the Network Time Protocol (NTP). They are also set through FTOS CLIs and hardware settings.

This chapter includes the following sections:

- Network Time Protocol
 - Protocol Overview
 - Implementation Information
 - Configuring Network Time Protocol
- FTOS Time and Date
 - Configuring time and date settings
 - Set daylight saving time

Network Time Protocol

Network Time Protocol (NTP) synchronizes timekeeping among a set of distributed time servers and clients. The protocol also coordinates time distribution in a large, diverse network with a variety of interfaces. In NTP, servers maintain the time and NTP clients synchronize with a time-serving host. NTP clients choose from among several NTP servers to determine which offers the best available source of time and the most reliable transmission of information.

NTP is a fault-tolerant protocol that will automatically select the best of several available time sources to synchronize to. Multiple candidates can be combined to minimize the accumulated error. Temporarily or permanently insane time sources will be detected and avoided.

Dell Force10 recommends configuring NTP for the most accurate time. In FTOS, other time sources can be configured (the hardware clock and the software clock).

NTP is designed to produce three products: clock offset, roundtrip delay, and dispersion, all of which are relative to a selected reference clock.

- **Clock offset** represents the amount to adjust the local clock to bring it into correspondence with the reference clock.

- **Roundtrip delay** provides the capability to launch a message to arrive at the reference clock at a specified time.
- **Dispersion** represents the maximum error of the local clock relative to the reference clock.

Since most host time servers will synchronize via another peer time server, there are two components in each of these three products, those determined by the peer relative to the primary reference source of standard time and those measured by the host relative to the peer.

Each of these components are maintained separately in the protocol in order to facilitate error control and management of the subnet itself. They provide not only precision measurements of offset and delay, but also definitive maximum error bounds, so that the user interface can determine not only the time, but the quality of the time as well.

In what may be the most common client/server model a client sends an NTP message to one or more servers and processes the replies as received. The server interchanges addresses and ports, overwrites certain fields in the message, recalculates the checksum and returns the message immediately. Information included in the NTP message allows the client to determine the server time with respect to local time and adjust the local clock accordingly. In addition, the message includes information to calculate the expected timekeeping accuracy and reliability, as well as select the best from possibly several servers.

Following conventions established by the telephone industry [BEL86], the accuracy of each server is defined by a number called the stratum, with the topmost level (primary servers) assigned as one and each level downwards (secondary servers) in the hierarchy assigned as one greater than the preceding level.

FTOS synchronizes with a time-serving host to get the correct time. You can set FTOS to poll specific NTP time-serving hosts for the current time. From those time-serving hosts, the system chooses one NTP host with which to synchronize and serve as a client to the NTP host. As soon as a host-client relationship is established, the networking device propagates the time information throughout its local network.

Protocol Overview

NTP message to one or more servers and processes the replies as received. The server interchanges addresses and ports, fills in or overwrites certain fields in the message, recalculates the checksum and returns it immediately. Information included in the NTP message allows each client/server peer to determine the timekeeping characteristics of its other peers, including the expected accuracies of their clocks. Using this information each peer is able to select the best time from possibly several other clocks, update the local clock and estimate its accuracy.

Figure 49-1. NTP Fields

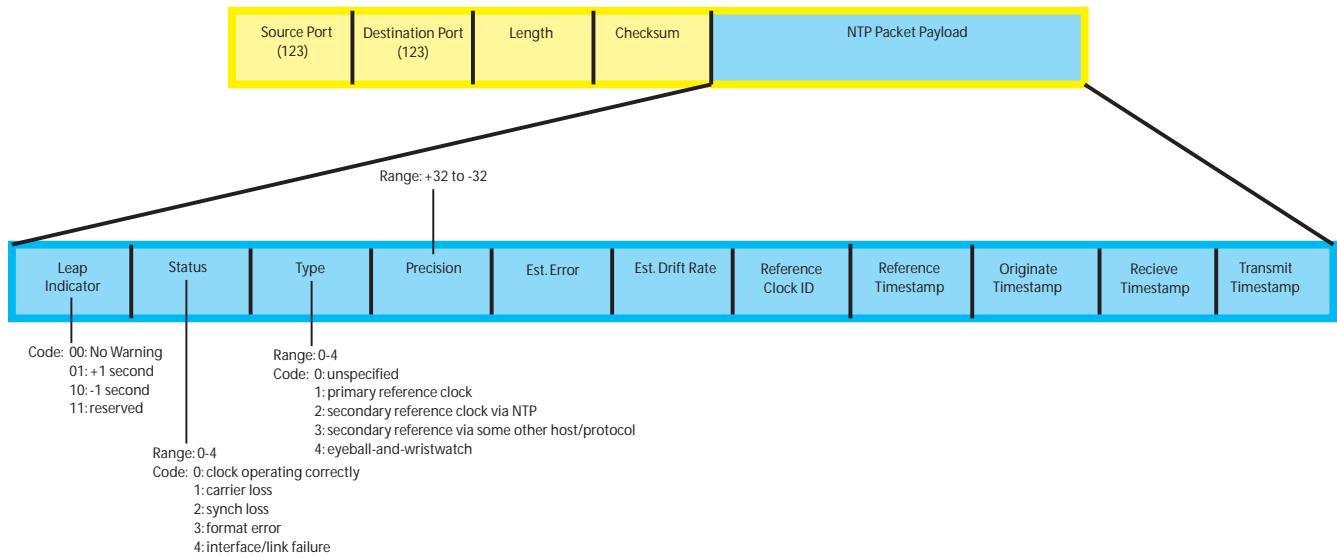

Implementation Information

- Dell Force10 systems can only be an NTP client.

Configuring Network Time Protocol

Configuring NTP is a one-step process:

1. Enable NTP. See [page 968](#).

Related Configuration Tasks

- [Configure NTP broadcasts on page 969](#)
- [Set the Hardware Clock with the Time Derived from NTP on page 968](#)
- [Set the Hardware Clock with the Time Derived from NTP on page 968](#)
- [Disable NTP on an interface on page 969](#)
- [Configure a source IP address for NTP packets on page 969 \(optional\)](#)

Enable NTP

NTP is disabled by default. To enable it, specify an NTP server to which the Dell Force10 system will synchronize. Enter the command multiple times to specify multiple servers. You may specify an unlimited number of servers at the expense of CPU resources.

| Task | Command | Command Mode |
|---|------------------------------------|---------------|
| Specify the NTP server to which the Dell Force10 system will synchronize. | <code>ntp server ip-address</code> | CONFIGURATION |

Display the system clock state with respect to NTP using the command `show ntp status` from EXEC Privilege mode, as shown in [Figure 49-2](#).

Figure 49-2. Displaying the System Clock State with respect to NTP

```
R6_E300(conf)#do show ntp status
Clock is synchronized, stratum 2, reference is 192.168.1.1
frequency is -369.623 ppm, stability is 53.319 ppm, precision is 4294967279
reference time is CD63BCC2.0CBBD000 (16:54:26.049 UTC Thu Mar 12 2009)
clock offset is 997.529984 msec, root delay is 0.00098 sec
root dispersion is 10.04271 sec, peer dispersion is 10032.715 msec
peer mode is client
```

Display the calculated NTP synchronization variables received from the server that the system will use to synchronize its clock using the command `show ntp associations` from EXEC Privilege mode, as shown in [Figure 49-3](#).

Figure 49-3. Displaying the Calculated NTP Synchronization Variables

```
R6_E300(conf)#do show ntp associations
  remote      ref clock      st when poll reach  delay  offset  disp
=====
#192.168.1.1  .LOCL.           1  16  16  76    0.98  -2.470  879.23
* master (syncd), # master (unsyncd), + selected, - candidate
```

Set the Hardware Clock with the Time Derived from NTP

| Task | Command | Command Mode |
|---|----------------------------------|---------------|
| Periodically update the system hardware clock with the time value derived from NTP. | <code>ntp update-calendar</code> | CONFIGURATION |

Figure 49-4. Displaying the Calculated NTP Synchronization Variables

```
R5/R8 (conf)#do show calendar
06:31:02 UTC Mon Mar 13 1989
R5/R8 (conf)#ntp update-calendar 1
R5/R8 (conf)#do show calendar
06:31:26 UTC Mon Mar 13 1989
R5/R8 (conf)#do show calendar
12:24:11 UTC Thu Mar 12 2009
```

Configure NTP broadcasts

With FTOS, you can receive broadcasts of time information. You can set interfaces within the system to receive NTP information through broadcast.

To configure an interface to receive NTP broadcasts, use the following commands in the INTERFACE mode:

| Task | Command | Command |
|---|----------------------|-----------|
| Set the interface to receive NTP packets. | ntp broadcast client | INTERFACE |

Table 49-1.

```
2w1d11h : NTP: Maximum Slew:-0.000470, Remainder = -0.496884
```

Disable NTP on an interface

By default, NTP is enabled on all active interfaces. If you disable NTP on an interface, FTOS drops any NTP packets sent to that interface.

To disable NTP on an interface, use the following command in the INTERFACE mode:

| Command Syntax | Command Mode | Purpose |
|----------------|--------------|-------------------------------|
| ntp disable | INTERFACE | Disable NTP on the interface. |

To view whether NTP is configured on the interface, use the show config command in the INTERFACE mode. If ntp disable is not listed in the show config command output, then NTP is enabled. (The show config command displays only non-default configuration information.)

Configure a source IP address for NTP packets

By default, the source address of NTP packets is the IP address of the interface used to reach the network. You can configure one interface's IP address to be included in all NTP packets.

To configure an IP address as the source address of NTP packets, use the following command in the CONFIGURATION mode:

| Command Syntax | Command Mode | Purpose |
|--|---------------|--|
| <code>ntp source <i>interface</i></code> | CONFIGURATION | Enter the following keywords and slot/port or number information: <ul style="list-style-type: none"> • For a 1-Gigabit Ethernet interface, enter the keyword <code>GigabitEthernet</code> followed by the slot/port information. • For a loopback interface, enter the keyword <code>loopback</code> followed by a number between 0 and 16383. • For a port channel interface, enter the keyword <code>lag</code> followed by a number from 1 to 255 for TeraScale and ExaScale, 1 to 32 for EtherScale. • For a SONET interface, enter the keyword <code>sonet</code> followed by the slot/port information. • For a 10-Gigabit Ethernet interface, enter the keyword <code>TenGigabitEthernet</code> followed by the slot/port information. • For a VLAN interface, enter the keyword <code>vlan</code> followed by a number from 1 to 4094. • For a 40-Gigabit Ethernet interface, enter the keyword <code>fortyGigE</code> followed by the slot/port information. |

To view the configuration, use the `show running-config ntp` command (Figure 38) in the EXEC privilege mode.

Configure NTP authentication

NTP authentication and the corresponding trusted key provide a reliable means of exchanging NTP packets with trusted time sources. NTP authentication begins when the first NTP packet is created following the configuration of keys. NTP authentication in FTOS uses the MD5 algorithm and the key is embedded in the synchronization packet that is sent to an NTP time source.

FTOS Behavior: FTOS versions 8.2.1.0 and later use an encryption algorithm to store the authentication key that is different from previous FTOS versions; beginning in version 8.2.1.0, FTOS uses DES encryption to store the key in the startup-config when you enter the command `ntp authentication-key`. Therefore, if your system boots with a startup-configuration from an FTOS versions prior to 8.2.1.0 in which you have configured `ntp authentication-key`, the system cannot correctly decrypt the key, and cannot authenticate NTP packets. In this case you must re-enter this command and save the running-config to the startup-config.

To configure NTP authentication, use these commands in the following sequence in the CONFIGURATION mode:

| Step | Command Syntax | Command Mode | Purpose |
|------|-------------------------------|---------------|----------------------------|
| 1 | <code>ntp authenticate</code> | CONFIGURATION | Enable NTP authentication. |

| Step | Command Syntax | Command Mode | Purpose |
|------|--|---------------|--|
| 2 | <code>ntp authentication-key <i>number</i> md5 <i>key</i></code> | CONFIGURATION | Set an authentication key. Configure the following parameters: <i>number</i> : Range 1 to 4294967295. This <i>number</i> must be the same as the <i>number</i> in the <code>ntp trusted-key</code> command. <i>key</i> : Enter a text string. This text string is encrypted. |
| 3 | <code>ntp trusted-key <i>number</i></code> | CONFIGURATION | Define a trusted key. Configure a number from 1 to 4294967295. The <i>number</i> must be the same as the <i>number</i> used in the <code>ntp authentication-key</code> command. |

To view the NTP configuration, use the `show running-config ntp` command (Figure 40) in the EXEC privilege mode. Figure 49-5 shows an encrypted authentication key. All keys are encrypted.

Figure 49-5. show running-config ntp Command Example

```

FTOS#show running ntp
!
ntp authenticate
ntp authentication-key 345 md5 5A60910F3D211F02 ← encrypted key
ntp server 11.1.1.1 version 3
ntp trusted-key 345
FTOS#

```

| Command Syntax | Command Mode | Purpose |
|--|---------------|---|
| <code>ntp server ip-address [key keyid] [prefer] [version number]</code> | CONFIGURATION | <p>Configure an NTP server. Configure the IP address of a server and the following optional parameters:</p> <ul style="list-style-type: none"> key <i>keyid</i>: Configure a text string as the key exchanged between the NTP server and client. prefer: Enter the keyword to set this NTP server as the preferred server. version <i>number</i>: Enter a number 1 to 3 as the NTP version. |

```
R6_E300(conf)#1w6d23h : NTP: xmit packet to 192.168.1.1:
 leap 0, mode 3, version 3, stratum 2, ppoll 1024
 rtdel 0219 (8.193970), rtdsp AF928 (10973.266602), refid C0A80101 (192.168.1.1)
 ref CD7F4F63.6BE8F000 (14:51:15.421 UTC Thu Apr 2 2009)
 org CD7F4F63.68000000 (14:51:15.406 UTC Thu Apr 2 2009)
 rec CD7F4F63.6BE8F000 (14:51:15.421 UTC Thu Apr 2 2009)
 xmt CD7F5368.D0535000 (15:8:24.813 UTC Thu Apr 2 2009)
1w6d23h : NTP: rcv packet from 192.168.1.1
 leap 0, mode 4, version 3, stratum 1, ppoll 1024
 rtdel 0000 (0.000000), rtdsp AF587 (10959.090820), refid 4C4F434C (76.79.67.76)
 ref CD7E14FD.43F7CED9 (16:29:49.265 UTC Wed Apr 1 2009)
 org CD7F5368.D0535000 (15:8:24.813 UTC Thu Apr 2 2009)
 rec CD7F5368.D0000000 (15:8:24.812 UTC Thu Apr 2 2009)
 xmt CD7F5368.D0000000 (15:8:24.812 UTC Thu Apr 2 2009)
 inp CD7F5368.D1974000 (15:8:24.818 UTC Thu Apr 2 2009)
```

```
rtdel-root delay
 rtdsp - round trip dispersion
 refid - reference id
 org -
 rec - (last?) receive timestamp
 xmt - transmit timestamp
```

```
mode - 3 client, 4 server
 stratum - 1 primary reference clock, 2 secondary reference clock (via NTP)
 version - NTP version 3
 leap -
```

- **Leap Indicator (sys.leap, peer.leap, pkt.leap)**: This is a two-bit code warning of an impending leap second to be inserted in the NTP time scale. The bits are set before 23:59 on the day of insertion and reset after 00:00 on the following day. This causes the number of seconds (rollover interval) in the day of insertion to be increased or decreased by one. In the case of primary servers the bits are set by operator intervention, while in the case of secondary servers the bits are set by the protocol. The two bits, bit 0 and bit 1, respectively, are coded as follows:
- **Poll Interval**: integer indicating the minimum interval between transmitted messages, in seconds as a power of two. For instance, a value of six indicates a minimum interval of 64 seconds.
- **Precision**: integer indicating the precision of the various clocks, in seconds to the nearest power of two. The value must be rounded to the next larger power of two; for instance, a 50-Hz (20 ms) or 60-Hz (16.67ms) power-frequency clock would be assigned the value -5 (31.25 ms), while a 1000-Hz (1 ms) crystal-controlled clock would be assigned the value -9 (1.95 ms).

- **Root Delay** (sys.rootdelay, peer.rootdelay, pkt.rootdelay): This is a signed fixed-point number indicating the total roundtrip delay to the primary reference source at the root of the synchronization subnet, in seconds. Note that this variable can take on both positive and negative values, depending on clock precision and skew.
- **Root Dispersion** (sys.rootdispersion, peer.rootdispersion, pkt.rootdispersion): This is a signed fixed-point number indicating the maximum error relative to the primary reference source at the root of the synchronization subnet, in seconds. Only positive values greater than zero are possible.
- **Reference Clock Identifier** (sys.refid, peer.refid, pkt.refid): This is a 32-bit code identifying the particular reference clock. In the case of stratum 0 (unspecified) or stratum 1 (primary reference source), this is a four-octet, left-justified, zero-padded ASCII string, for example: the case of stratum 2 and greater (secondary reference) this is the four-octet Internet address of the peer selected for synchronization.
- **Reference Timestamp** (sys.reftime, peer.reftime, pkt.reftime): This is the local time, in timestamp format, when the local clock was last updated. If the local clock has never been synchronized, the value is zero.
- **Originate Timestamp**: The departure time on the server of its last NTP message. If the server becomes unreachable, the value is set to zero.
- **Receive Timestamp**: The arrival time on the client of the last NTP message from the server. If the server becomes unreachable, the value is set to zero.
- **Transmit Timestamp**: The departure time on the server of the current NTP message from the sender.
- Filter dispersion is the error in calculating the minimum delay from a set of sample data from a peer.

FTOS Time and Date

The time and date can be set using the FTOS CLI.

Configuring time and date settings

The following list includes the configuration tasks for setting the system time:

- [Set the time and date for the switch hardware clock](#)
- [Set the time and date for the switch software clock](#)
- [Set the timezone](#)
- [Set daylight saving time](#)
 - [Set Daylight Saving Time Once](#)
 - [Set Recurring Daylight Saving Time](#)

Set the time and date for the switch hardware clock

| Command Syntax | Command Mode | Purpose |
|---|----------------|---|
| calendar set <i>time month day year</i> | EXEC Privilege | <p>Set the hardware clock to the current time and date.</p> <p>time: Enter the time in hours:minutes:seconds. For the hour variable, use the 24-hour format, for example, 17:15:00 is 5:15 pm.</p> <p>month: Enter the name of one of the 12 months in English.</p> <p>You can enter the name of a day to change the order of the display to <i>time day month year</i>.</p> <p>day: Enter the number of the day.</p> <p>Range: 1 to 31.</p> <p>You can enter the name of a month to change the order of the display to <i>time day month year</i>.</p> <p>year: Enter a four-digit number as the year.</p> <p>Range: 1993 to 2035.</p> |

```
FTOS#calendar set 08:55:00 september 18 2009
FTOS#
```

Set the time and date for the switch software clock

You can change the order of the *month* and *day* parameters to enter the time and date as *time day month year*. You cannot delete the software clock.

The software clock runs only when the software is up. The clock restarts, based on the hardware clock, when the switch reboots.

| Command Syntax | Command Mode | Purpose |
|--------------------------------------|----------------|---|
| clock set <i>time month day year</i> | EXEC Privilege | <p>Set the system software clock to the current time and date.</p> <p><i>time</i>: Enter the time in hours:minutes:seconds. For the hour variable, use the 24-hour format, for example, 17:15:00 is 5:15 pm.</p> <p><i>month</i>: Enter the name of one of the 12 months in English. You can enter the name of a day to change the order of the display to <i>time day month year</i>.</p> <p><i>day</i>: Enter the number of the day. Range: 1 to 31.</p> <p>You can enter the name of a month to change the order of the display to <i>time day month year</i>.</p> <p><i>year</i>: Enter a four-digit number as the year. Range: 1993 to 2035.</p> |

```
FTOS#clock set 16:20:00 19 september 2009
FTOS#
```

Set the timezone

Coordinated Universal Time (UTC) is the time standard based on the International Atomic Time standard, commonly known as Greenwich Mean time. When determining system time, you must include the differentiator between UTC and your local timezone. For example, San Jose, CA is the Pacific Timezone with a UTC offset of -8.

| Command Syntax | Command Mode | Purpose |
|--|---------------|---|
| clock timezone <i>timezone-name offset</i> | CONFIGURATION | <p>Set the clock to the appropriate timezone.</p> <p><i>timezone-name</i>: Enter the name of the timezone. Do not use spaces.</p> <p><i>offset</i>: Enter one of the following:</p> <ul style="list-style-type: none">• a number from 1 to 23 as the number of hours in addition to UTC for the timezone.• a minus sign (-) followed by a number from 1 to 23 as the number of hours |

Command Syntax**Command Mode****Purpose**

```
FTOS#conf
FTOS(conf)#clock timezone Pacific -8
FTOS(conf)#01:40:19: %RPM0-P:CP %CLOCK-6-TIME CHANGE: Timezone
configuration changed from "UTC 0 hrs 0 mins" to "Pacific -8 hrs 0
mins"
FTOS#
```

Set daylight saving time

FTOS supports setting the system to daylight saving time once or on a recurring basis every year.

Set Daylight Saving Time Once

Set a date (and time zone) on which to convert the switch to daylight saving time on a one-time basis.

| Command Syntax | Command Mode | Purpose |
|--|---------------|---|
| <code>clock summer-time time-zone date start-month start-day start-year start-time end-month end-day end-year end-time [offset]</code> | CONFIGURATION | <p>Set the clock to the appropriate timezone and daylight saving time.</p> <p><i>time-zone</i>: Enter the three-letter name for the time zone. This name is displayed in the show clock output.</p> <p><i>start-month</i>: Enter the name of one of the 12 months in English. You can enter the name of a day to change the order of the display to <i>time day month year</i>.</p> <p><i>start-day</i>: Enter the number of the day. Range: 1 to 31. You can enter the name of a month to change the order of the display to <i>time day month year</i>.</p> <p><i>start-year</i>: Enter a four-digit number as the year. Range: 1993 to 2035</p> <p><i>start-time</i>: Enter the time in hours:minutes. For the hour variable, use the 24-hour format, example, 17:15 is 5:15 pm.</p> <p><i>end-month</i>: Enter the name of one of the 12 months in English. You can enter the name of a day to change the order of the display to <i>time day month year</i>.</p> <p><i>end-day</i>: Enter the number of the day. Range: 1 to 31. You can enter the name of a month to change the order of the display to <i>time day month year</i>.</p> <p><i>end-year</i>: Enter a four-digit number as the year. Range: 1993 to 2035.</p> <p><i>end-time</i>: Enter the time in hours:minutes. For the hour variable, use the 24-hour format, example, 17:15 is 5:15 pm.</p> <p><i>offset</i>: (OPTIONAL) Enter the number of minutes to add during the summer-time period. Range: 1 to 1440. Default: 60 minutes</p> |

```
FTOS(conf)#clock summer-time pacific date Mar 14 2009 00:00 Nov 7 2009 00:00
FTOS(conf)#02:02:13: %RPM0-P:CP %CLOCK-6-TIME CHANGE: Summertime configuration changed from
"none" to "Summer time starts 00:00:00 Pacific Sat Mar 14 2009;Summer time ends 00:00:00 pacific
Sat Nov 7 2009"
```

Set Recurring Daylight Saving Time

Set a date (and time zone) on which to convert the switch to daylight saving time on a specific day every year.

If you have already set daylight saving for a one-time setting, you can set that date and time as the recurring setting with the clock summer-time *time-zone* recurring command.

| Command Syntax | Command Mode | Purpose |
|---|---------------|--|
| clock summer-time <i>time-zone</i> recurring <i>start-week start-day</i> <i>start-month start-time</i> <i>end-week end-day</i> <i>end-month end-time</i> [offset] | CONFIGURATION | Set the clock to the appropriate timezone and adjust to daylight saving time every year. <i>time-zone</i> : Enter the three-letter name for the time zone. This name is displayed in the show clock output. <i>start-week</i> : (OPTIONAL) Enter one of the following as the week that daylight saving begins and then enter values for <i>start-day</i> through <i>end-time</i> : <ul style="list-style-type: none"> <i>week-number</i>: Enter a number from 1-4 as the number of the week in the month to start daylight saving time. <i>first</i>: Enter this keyword to start daylight saving time in the first week of the month. <i>last</i>: Enter this keyword to start daylight saving time in the last week of the month. <i>start-month</i> : Enter the name of one of the 12 months in English. You can enter the name of a day to change the order of the display to <i>time day month year</i> <i>start-day</i> : Enter the number of the day. Range: 1 to 31. You can enter the name of a month to change the order of the display to <i>time day month year</i> . |

| Command Syntax | Command Mode | Purpose |
|----------------|--------------|---|
| | | <p><i>start-year</i>: Enter a four-digit number as the year. Range: 1993 to 2035</p> <p><i>start-time</i>: Enter the time in hours:minutes. For the hour variable, use the 24-hour format, example, 17:15 is 5:15 pm.</p> <p><i>end-week</i>: <i>If you entered a start-week</i>, Enter the one of the following as the week that daylight saving ends:</p> <ul style="list-style-type: none"> <i>week-number</i>: enter a number from 1-4 as the number of the week to end daylight saving time. <i>first</i>: enter the keyword first to end daylight saving time in the first week of the month. <i>last</i>: enter the keyword last to end daylight saving time in the last week of the month. <p><i>end-month</i>: Enter the name of one of the 12 months in English. You can enter the name of a day to change the order of the display to <i>time day month year</i>.</p> <p><i>end-day</i>: Enter the number of the day. Range: 1 to 31. You can enter the name of a month to change the order of the display to <i>time day month year</i>.</p> <p><i>end-year</i>: Enter a four-digit number as the year. Range: 1993 to 2035.</p> <p><i>end-time</i>: Enter the time in hours:minutes. For the hour variable, use the 24-hour format, example, 17:15 is 5:15 pm.</p> <p><i>offset</i>: (OPTIONAL) Enter the number of minutes to add during the summer-time period. Range: 1 to 1440. Default: 60 minutes</p> |

```
FTOS(conf)#clock summer-time pacific recurring Mar 14 2009 00:00 Nov 7 2009 00:00 ?
FTOS(conf)#02:02:13: %RPM0-P:CP %CLOCK-6-TIME CHANGE: Summertime configuration changed from
"none" to "Summer time starts 00:00:00 Pacific Sat Mar 14 2009;Summer time ends 00:00:00 pacific
Sat Nov 7 2009"
```

Note: If you enter <CR> after entering the recurring command parameter, and you have already set a one-time daylight saving time/date, the system will use that time and date as the recurring setting.

Command Syntax**Command Mode****Purpose**

```
FTOS(conf)#clock summer-time pacific recurring ?
```

```
<1-4>                Week number to start
```

```
first                Week number to start
```

```
last                 Week number to start
```

```
<cr>
```

```
FTOS(conf)#clock summer-time pacific recurring
```

```
FTOS(conf)#02:10:57: %RPM0-P:CP %CLOCK-6-TIME CHANGE: Summertime configuration changed from
"Summer time starts 00:00:00 Pacific Sat Mar 14 2009 ; Summer time ends 00:00:00 pacific Sat Nov
7 2009" to "Summer time starts 02:00:00 Pacific Sun Mar 8 2009;Summer time ends 02:00:00 pacific
Sun Nov 1 2009"
```

Uplink Failure Detection (UFD)

Uplink Failure Detection (UFD) is supported on the following platforms: S (S50 only) and **S4810** **S4820T**

Feature Description

Uplink Failure Detection (UFD) provides detection of the loss of upstream connectivity and, if used with NIC teaming, automatic recovery from a failed link.

A switch provides upstream connectivity for devices, such as servers. If a switch loses its upstream connectivity, downstream devices also lose their connectivity. However, the devices do not receive a direct indication that upstream connectivity is lost since connectivity to the switch is still operational.

UFD allows a switch to associate downstream interfaces with upstream interfaces. When upstream connectivity fails, the switch disables the downstream links. Failures on the downstream links allow downstream devices to recognize the loss of upstream connectivity.

For example, in [Figure 50-2](#) Switches S1 and S2 both have upstream connectivity to Router R1 and downstream connectivity to the server. UFD operation is shown in Steps A through C:

- In Step A, the server configuration uses the connection to S1 as the primary path. Network traffic flows from the server to S1 and then upstream to R1.
- In Step B, the upstream link between S1 and R1 fails. The server continues to use the link to S1 for its network traffic, but the traffic is not successfully switched through S1 because the upstream link is down.
- In Step C, UFD on S1 disables the link to the server. The server then stops using the link to S1 and switches to using its link to S2 to send traffic upstream to R1.

Figure 50-1. Uplink Failure Detection

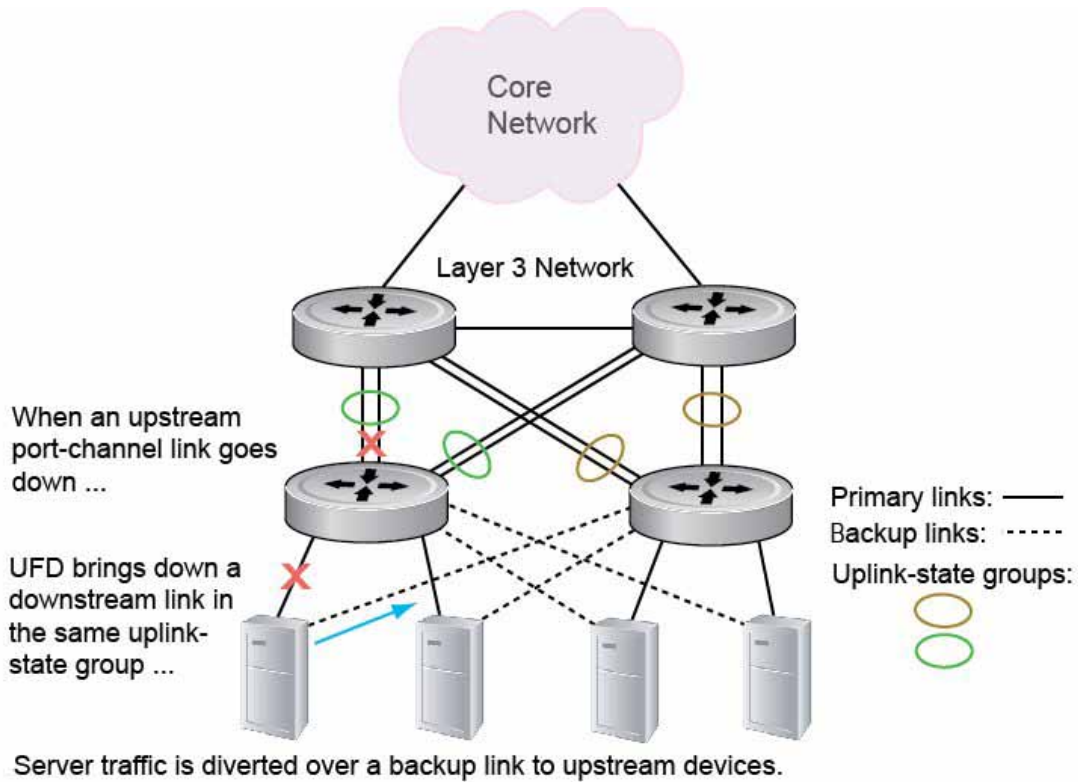

How Uplink Failure Detection Works

UFD creates an association between upstream and downstream interfaces. The association of uplink and downlink interfaces is called an *uplink-state group*. An interface in an uplink-state group can be a physical interface or a port-channel (LAG) aggregation of physical interfaces.

An enabled uplink-state group tracks the state of all assigned upstream interfaces. Failure on an upstream interface results in the automatic disabling of downstream interfaces in the uplink-state group. As a result, downstream devices can execute the protection or recovery procedures they have in place to establish alternate connectivity paths as shown in [Figure 50-2](#).

Figure 50-2. Uplink Failure Detection Example

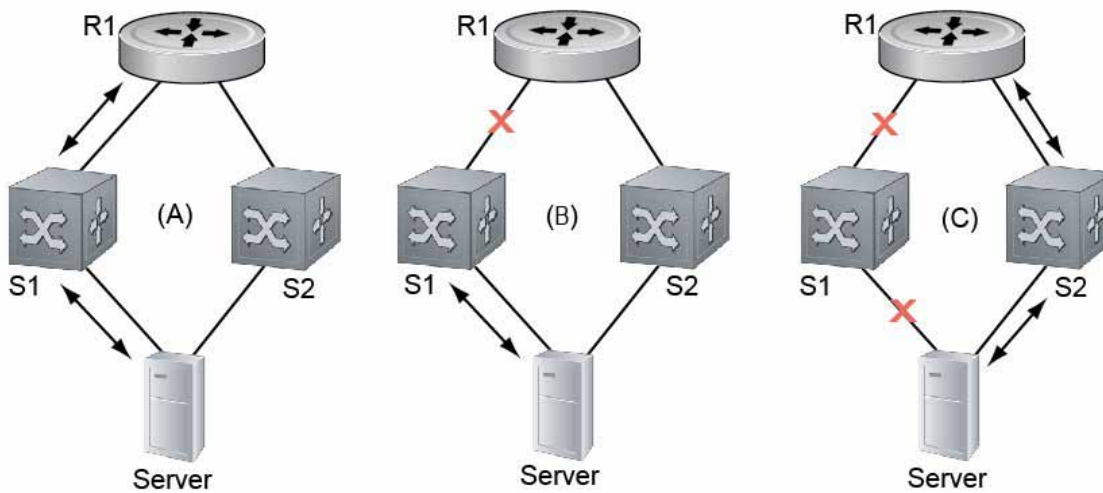

- A: Switches1 and 2 have upstream and downstream connections to Router1 and Server via primary links.
- B: Upstream link between Switch1 and Router1 fails. Downstream link with Server stays up temporarily.
- C: Switch1 disables downstream link to Server. Server starts to connect with Router1 using backup link to Switch2; Switch2 starts to use the backup link to Router1.

If only one of the upstream interfaces in an uplink-state group goes down, a specified number of downstream ports associated with the upstream interface are put into a link-down state. This number is user-configurable and is calculated by the ratio of upstream port bandwidth to downstream port bandwidth in the same uplink-state group. This calculation ensures that there are no traffic drops due to insufficient bandwidth on the upstream links to the routers/switches.

By default, if all upstream interfaces in an uplink-state group go down, all downstream interfaces in the same uplink-state group are put into a link-down state.

Using UFD, you can configure the automatic recovery of downstream ports in an uplink-state group when the link status of an upstream port changes. The tracking of upstream link status does not have a major impact on CPU usage.

UFD and NIC Teaming

Uplink Failure Detection on a switch can be used with network adapter teaming on a server (see [NIC Teaming on page 594](#)) to implement a rapid failover solution. For example, in [Figure 50-2](#) the switch/router with UFD detects the uplink failure and automatically disables the associated downstream link port to the server. The server with NIC teaming detects the disabled link and automatically switches over to the backup link in order to continue to transmit traffic upstream.

Important Points to Remember

When you configure Uplink Failure Detection, the following conditions apply:

- You can configure up to sixteen uplink-state groups. By default, no uplink-state groups are created. An uplink-state group is considered to be operationally *up* if it has at least one upstream interface in the link-up state. An uplink-state group is considered to be operationally *down* if it has no upstream interfaces in the link-up state. No uplink-state tracking is performed when a group is disabled or in an operationally down state.
- You can assign physical port or port-channel interfaces to an uplink-state group. You can assign an interface to only one uplink-state group. Each interface assigned to an uplink-state group must be configured as either an upstream or downstream interface, but not both. You can assign individual member ports of a port channel to the group. An uplink-state group can contain either the member ports of a port channel or the port channel itself, but not both. If you assign a port channel as an upstream interface, the port channel interface enters a link-down state when the number of port-channel member interfaces in a link-up state drops below the configured Minimum Number of Members parameter.
- If one of the upstream interfaces in an uplink-state group goes down, either a user-configurable set of downstream ports or all the downstream ports in the group are put in an operationally down state with an UFD Disabled error. The order in which downstream ports are disabled is from the lowest numbered port to the highest. If one of the upstream interfaces in an uplink-state group that was down comes up, the set of UFD-disabled downstream ports (which were previously disabled due to this upstream port going down) are brought up and the UFD Disabled error is cleared.
- If an uplink-state group is disabled, the downstream interfaces are not disabled regardless of the state of the upstream interfaces. If an uplink-state group has no upstream interfaces assigned, downstream interfaces cannot be disabled when an upstream link goes down.
- To enable the debug messages for events related to a specified uplink-state group or all groups, enter the **debug uplink-state-group** [*group-id*] command, where *group-id* is 1 to 16. To turn off debugging event messages, enter the **no debug uplink-state-group** [*group-id*] command. For an example of debug log messages, see [Message 1](#).

Configuring Uplink Failure Detection

To configure Uplink Failure Detection, follow these steps:

| Step | Command Syntax and Mode | Description |
|------|---|---|
| 1 | uplink-state-group <i>group-id</i> Command Mode: CONFIGURATION | Creates an uplink-state group and enabling the tracking of upstream links on the switch/router. Valid <i>group-id</i> values are 1 to 16. To delete an uplink-state group, enter the no uplink-state-group <i>group-id</i> command. |
| 2 | {upstream downstream} <i>interface</i> Command Mode: UPLINK-STATE-GROUP | Assigns a port or port-channel to the uplink-state group as an upstream or downstream interface. For <i>interface</i> , enter one of the following interface types: Fast Ethernet: fastethernet <i>{slot/port slot/port-range}</i> 1-Gigabit Ethernet: gigabitethernet <i>{slot/port slot/port-range}</i> 10-Gigabit Ethernet: tengigabitethernet <i>{slot/port slot/port-range}</i> Port channel: port-channel <i>{1-512 port-channel-range}</i> Where <i>port-range</i> and <i>port-channel-range</i> specify a range of ports separated by a dash (-) and/or individual ports/port channels in any order; for example: <pre>upstream gigabitethernet 1/1-2,5,9,11-12 downstream port-channel 1-3,5</pre> A comma is required to separate each port and port-range entry. To delete an interface from the group, enter the no {upstream downstream} interface command. |
| 3 | downstream disable links {number all} Command Mode: UPLINK-STATE-GROUP | Configures the number of downstream links in the uplink-state group that will be disabled (Oper Down state) if one upstream link in the group goes down. <i>number</i> specifies the number of downstream links to be brought down. Range: 1 to 1024. all brings down all downstream links in the group. Default: No downstream links are disabled when an upstream link goes down. Note: Downstream interfaces in an uplink-state group are put into a link-down state with an UFD-Disabled error message only when all upstream interfaces in the group go down. To revert to the default setting, enter the no downstream disable links command. |
| 4 | downstream auto-recover Command Mode: UPLINK-STATE-GROUP | (Optional) Enables auto-recovery so that UFD-disabled downstream ports in the uplink-state group come up when a disabled upstream port in the group comes back up. Default: Auto-recovery of UFD-disabled downstream ports is enabled. To disable auto-recovery, enter the no downstream auto-recover command. |

| Step | Command Syntax and Mode | Description |
|------|---|--|
| 5 | description <i>text</i> Command Mode: UPLINK-STATE-GROUP | (Optional) Enters a text description of the uplink-state group. Maximum length: 80 alphanumeric characters. |
| 6 | no enable Command Mode: UPLINK-STATE-GROUP | (Optional) Disables upstream-link tracking without deleting the uplink-state group. Default: Upstream-link tracking is automatically enabled in an uplink-state group. To re-enable upstream-link tracking, enter the enable command. |

Clearing a UFD-Disabled Interface

You can manually bring up a downstream interface in an uplink-state group that has been disabled by UFD and is in a UFD-disabled error state. To re-enable one or more disabled downstream interfaces and clear the UFD-disabled error state, enter the following command:

| Command Syntax | Description |
|--|--|
| clear ufd-disable { interface <i>interface</i> uplink-state-group <i>group-id</i> } Command Mode: EXEC | Re-enables a downstream interface on the switch/router that is in a UFD-disabled error state so that it can send and receive traffic. For <i>interface</i> , enter one of the following interface types: Fast Ethernet: fastethernet { <i>slot/port</i> <i>slot/port-range</i> } 1-Gigabit Ethernet: gigabitethernet { <i>slot/port</i> <i>slot/port-range</i> } 10-Gigabit Ethernet: tengigabitethernet { <i>slot/port</i> <i>slot/port-range</i> } Port channel: port-channel {1-512 <i>port-channel-range</i> } Where <i>port-range</i> and <i>port-channel-range</i> specify a range of ports separated by a dash (-) and/or individual ports/port channels in any order; for example: gigabitethernet 1/1-2, 5, 9, 11-12 port-channel 1-3, 5 A comma is required to separate each port and port-range entry. clear ufd-disable { interface <i>interface</i> uplink-state-group <i>group-id</i> } re-enables all UFD-disabled downstream interfaces in the group. Range: 1 to 16. |

Message 1 shows the Syslog messages displayed when you clear the UFD-disabled state from all disabled downstream interfaces in an uplink-state group by entering the **clear ufd-disable uplink-state-group group-id** command. All downstream interfaces return to an operationally up state.

Message 1 Syslog Messages before and after entering clear ufd-disable uplink-state-group Command (S50)

```
02:36:43: %RPM0-P:CP %IFMGR-5-ASTATE_DN: Changed interface Admin state to down: Te 0/
46 02:36:43: %RPM0-P:CP %IFMGR-5-OSTATE_DN: Changed interface state to down: Te 0/46
02:36:43: %RPM0-P:CP %IFMGR-5-OSTATE_DN: Downstream interface set to UFD error-disabled: Fo 13/0
02:36:43: %RPM0-P:CP %IFMGR-5-OSTATE_DN: Downstream interface set to UFD error-disabled: Fo 13/1
02:36:43: %RPM0-P:CP %IFMGR-5-OSTATE_DN: Downstream interface set to UFD error-disabled: Fo 13/3
02:36:43: %RPM0-P:CP %IFMGR-5-OSTATE_DN: Downstream interface set to UFD error-disabled: Fo 13/5
02:36:43: %RPM0-P:CP %IFMGR-5-OSTATE_DN: Changed interface state to down: Fo 13/0
02:36:43: %RPM0-P:CP %IFMGR-5-OSTATE_DN: Changed interface state to down: Fo 13/1
02:36:43: %RPM0-P:CP %IFMGR-5-OSTATE_DN: Changed interface state to down: Fo 13/3
02:36:43: %RPM0-P:CP %IFMGR-5-OSTATE_DN: Changed interface state to down: Fo 13/5

02:37:29: %RPM0-P:CP %IFMGR-5-ASTATE_DN: Changed interface Admin state to down: Te 0/
47 02:37:29: %RPM0-P:CP %IFMGR-5-OSTATE_DN: Changed interface state to down: Te 0/47
02:37:29 : UFD: Group:3, UplinkState: DOWN

02:37:29: %RPM0-P:CP %IFMGR-5-OSTATE_DN: Changed uplink state group state to down: Group 3
02:37:29: %RPM0-P:CP %IFMGR-5-OSTATE_DN: Downstream interface set to UFD error-disabled: Fo 13/6
02:37:29: %RPM0-P:CP %IFMGR-5-OSTATE_DN: Changed interface state to down: Fo 13/6

02:38:31 : UFD: Group:3, UplinkState: UP
02:38:31: %RPM0-P:CP %IFMGR-5-OSTATE_UP: Changed uplink state group state to up: Group 3

02:38:53: %RPM0-P:CP %IFMGR-5-OSTATE_UP: Downstream interface cleared from UFD error-disabled: Fo 13/0
02:38:53: %RPM0-P:CP %IFMGR-5-OSTATE_UP: Downstream interface cleared from UFD error-disabled: Fo 13/1
02:38:53: %RPM0-P:CP %IFMGR-5-OSTATE_UP: Downstream interface cleared from UFD error-disabled: Fo 13/3
02:38:53: %RPM0-P:CP %IFMGR-5-OSTATE_UP: Downstream interface cleared from UFD error-disabled: Fo 13/5
02:38:53: %RPM0-P:CP %IFMGR-5-OSTATE_UP: Downstream interface cleared from UFD error-disabled: Fo 13/6
02:38:53: %RPM0-P:CP %IFMGR-5-OSTATE_UP: Changed interface state to up: Fo 13/0
02:38:53: %RPM0-P:CP %IFMGR-5-OSTATE_UP: Changed interface state to up: Fo 13/1
02:38:53: %RPM0-P:CP %IFMGR-5-OSTATE_UP: Changed interface state to up: Fo 13/3
02:38:53: %RPM0-P:CP %IFMGR-5-OSTATE_UP: Changed interface state to up: Fo 13/5
02:38:53: %RPM0-P:CP %IFMGR-5-OSTATE_UP: Changed interface state to up: Fo 13/6
```

Displaying Uplink Failure Detection

To display information on the Uplink Failure Detection feature, enter any of the following **show** commands:

| Show Command Syntax | Description |
|---|--|
| <p>show uplink-state-group [<i>group-id</i>] [detail] Command Mode: EXEC</p> | <p>Displays status information on a specified uplink-state group or all groups. Valid <i>group-id</i> values are 1 to 16.</p> <p>detail displays additional status information on the upstream and downstream interfaces in each group (see Figure 50-3).</p> |
| <p>show interfaces <i>interface</i> Command Mode: EXEC</p> | <p>Displays the current status of a port or port-channel interface assigned to an uplink-state group.</p> <p><i>interface</i> specifies one of the following interface types: Fast Ethernet: Enter fastethernet <i>slot/port</i>. 1-Gigabit Ethernet: Enter gigabithernet <i>slot/port</i>. 10-Gigabit Ethernet: Enter tengigabithernet <i>slot/port</i>. Port channel: Enter port-channel {1-512}.</p> <p>If a downstream interface in an uplink-state group has been disabled (Oper Down state) by uplink-state tracking because an upstream port went down, the message error-disabled[UFD] is displayed in the output (see Figure 50-4).</p> |
| <p>show running-config uplink-state-group [<i>group-id</i>] Command Mode: EXEC Or show configuration Command Mode: UPLINK-STATE-GROUP</p> | <p>Displays the current configuration of all uplink-state groups (Figure 50-5) or a specified group (Figure 50-6). Valid <i>group-id</i> values are 1 to 16.</p> |

Figure 50-3. show uplink-state-group Command Output (S50)

```
FTOS# show uplink-state-group

Uplink State Group: 1   Status: Enabled, Up
Uplink State Group: 3   Status: Enabled, Up
Uplink State Group: 5   Status: Enabled, Down
Uplink State Group: 6   Status: Enabled, Up
Uplink State Group: 7   Status: Enabled, Up
Uplink State Group: 16  Status: Disabled, Up

FTOS# show uplink-state-group 16
Uplink State Group: 16  Status: Disabled, Up

FTOS#show uplink-state-group detail
(Up): Interface up      (Dwn): Interface down  (Dis): Interface disabled

Uplink State Group   : 1           Status: Enabled, Up
Upstream Interfaces  :
Downstream Interfaces:

Uplink State Group   : 3           Status: Enabled, Up
Upstream Interfaces  : Gi 0/46(Up) Gi 0/47(Up)
Downstream Interfaces: Te 13/0(Up) Te 13/1(Up) Te 13/3(Up) Te 13/5(Up) Te 13/6(Up)

Uplink State Group   : 5           Status: Enabled, Down
Upstream Interfaces  : Gi 0/0(Dwn) Gi 0/3(Dwn) Gi 0/5(Dwn)
Downstream Interfaces: Te 13/2(Dis) Te 13/4(Dis) Te 13/11(Dis) Te 13/12(Dis) Te 13/13(Dis)
                    Te 13/14(Dis) Te 13/15(Dis)

Uplink State Group   : 6           Status: Enabled, Up
Upstream Interfaces  :
Downstream Interfaces:

Uplink State Group   : 7           Status: Enabled, Up
Upstream Interfaces  :
Downstream Interfaces:

Uplink State Group   : 16          Status: Disabled, Up
Upstream Interfaces  : Gi 0/41(Dwn) Po 8(Dwn)
Downstream Interfaces: Gi 0/40(Dwn)
```

Figure 50-4. show interfaces Command: UFD Output (S50)

```

FTOS#show interfaces gigabitethernet 7/45
GigabitEthernet 7/45 is up, line protocol is down (error-disabled[UFD])
Hardware is Force10Eth, address is 00:01:e8:32:7a:47
  Current address is 00:01:e8:32:7a:47
Interface index is 280544512
Internet address is not set
MTU 1554 bytes, IP MTU 1500 bytes
LineSpeed 1000 Mbit, Mode auto
Flowcontrol rx off tx off
ARP type: ARPA, ARP Timeout 04:00:00
Last clearing of "show interface" counters 00:25:46
Queueing strategy: fifo
Input Statistics:
  0 packets, 0 bytes
  0 64-byte pkts, 0 over 64-byte pkts, 0 over 127-byte pkts
  0 over 255-byte pkts, 0 over 511-byte pkts, 0 over 1023-byte pkts
  0 Multicasts, 0 Broadcasts
  0 runts, 0 giants, 0 throttles
  0 CRC, 0 overrun, 0 discarded
Output Statistics:
  0 packets, 0 bytes, 0 underruns
  0 64-byte pkts, 0 over 64-byte pkts, 0 over 127-byte pkts
  0 over 255-byte pkts, 0 over 511-byte pkts, 0 over 1023-byte pkts
  0 Multicasts, 0 Broadcasts, 0 Unicasts
  0 throttles, 0 discarded, 0 collisions
Rate info (interval 299 seconds):
  Input 00.00 Mbits/sec,          0 packets/sec, 0.00% of line-rate
  Output 00.00 Mbits/sec,        0 packets/sec, 0.00% of line-rate
Time since last interface status change: 00:01:23

```

Figure 50-5. show running-config uplink-state-group Command: UFD Output (S50)

```

FTOS#show running-config uplink-state-group
!
no enable
uplink state track 1
downstream GigabitEthernet 0/2, 4, 6, 11-19
upstream TengigabitEthernet 0/48, 52
upstream PortChannel 1
!
uplink state track 2
downstream GigabitEthernet 0/1, 3, 5, 7-10
upstream TengigabitEthernet 0/56, 60

```

Figure 50-6. show configuration Command: UFD Output (S50)

```

FTOS(conf-uplink-state-group-16)# show configuration
!
uplink-state-group 16
no enable
description test
downstream disable links all
downstream GigabitEthernet 0/40
upstream GigabitEthernet 0/41
upstream Port-channel 8

```

Sample Configuration: Uplink Failure Detection

Figure 50-7 shows a sample configuration of Uplink Failure Detection on a switch/router in which you:

- Configure uplink-state group 3.
- Add downstream links GigabitEthernet 0/1, 0/2, 0/5, 0/9, 0/11, and 0/12.
- Configure two downstream links to be disabled if an upstream link fails.
- Add upstream links GigabitEthernet 0/3 and 0/4.
- Add a text description for the group.
- Verify the configuration with various **show** commands.

Figure 50-7. Configuring Uplink Failure Detection (S50)

```
FTOS(conf)# uplink-state-group 3
00:08:11: %STKUNIT0-M:CP %IFMGR-5-ASTATE_UP: Changed uplink state group Admin state to up:
Group 3
FTOS(conf-uplink-state-group-3)# downstream gigabitEthernet 0/1-2,5,9,11-12
FTOS(conf-uplink-state-group-3)# downstream disable links 2
FTOS(conf-uplink-state-group-3)# upstream gigabitEthernet 0/3-4
00:10:00: %STKUNIT0-M:CP %IFMGR-5-OSTATE_DN: Downstream interface set to UFD error-disabled:
Gi 0/1
FTOS#
00:10:00: %STKUNIT0-M:CP %IFMGR-5-OSTATE_DN: Changed interface state to down: Gi 0/1
FTOS(conf-uplink-state-group-3)# description Testing UFD feature

FTOS(conf-uplink-state-group-3)# show config
!
uplink-state-group 3
description Testing UFD feature
downstream disable links 2
downstream GigabitEthernet 0/1-2,5,9,11-12
upstream GigabitEthernet 0/3-4
FTOS(conf-uplink-state-group-3)#
FTOS(conf-uplink-state-group-3)#exit
FTOS(conf)#exit
FTOS#
00:13:06: %STKUNIT0-M:CP %SYS-5-CONFIG_I: Configured from console by console

FTOS# show running-config uplink-state-group
!
uplink-state-group 3
description Testing UFD feature
downstream disable links 2
downstream GigabitEthernet 0/1-2,5,9,11-12
upstream GigabitEthernet 0/3-4

FTOS# show uplink-state-group 3

Uplink State Group: 3   Status: Enabled, Up

FTOS# show uplink-state-group detail

(Up): Interface up      (Dwn): Interface down  (Dis): Interface disabled
Uplink State Group    : 3           Status: Enabled, Up
Upstream Interfaces   : Gi 0/3(Up) Gi 0/4(Dwn)
Downstream Interfaces : Gi 0/1(Dis) Gi 0/2(Dwn) Gi 0/5(Dwn) Gi 0/9(Dwn) Gi 0/11(Dwn)
                       Gi 0/12(Dwn)
```

Upgrade Procedures

Find the upgrade procedures

Go to the FTOS Release Notes for your system type to see all the requirements to upgrade to the desired FTOS version. Follow the procedures in the FTOS Release Notes for the software version you wish to upgrade to.

Get Help with upgrades

Direct any questions or concerns about FTOS Upgrade Procedures to the Dell Force10 Technical Support Center. You can reach Technical Support:

- On the Web: www.force10networks.com/support/
- By email: support@force10networks.com
- By phone: US and Canada: 866.965.5800, International: 408.965.5800

Virtual LANs (VLAN)

Virtual LANs (VLAN) are supported on platforms: [E](#) [C](#) [S](#) [S4810](#) [S4820T](#)

This section contains the following subsections:

- [Default VLAN](#)
- [Port-Based VLANs](#)
- [VLANs and Port Tagging](#)
- [Configuration Task List for VLANs](#)
- [Enable Null VLAN as the Default VLAN](#)

Virtual LANs, or VLANs, are a logical broadcast domain or logical grouping of interfaces in a LAN in which all data received is kept locally and broadcast to all members of the group. When in Layer 2 mode, VLANs move traffic at wire speed and can span multiple devices. FTOS supports up to 4093 port-based VLANs and 1 Default VLAN, as specified in IEEE 802.1Q.

VLANs provide the following benefits:

- Improved security because you can isolate groups of users into different VLANs
- Ability to create one VLAN across multiple devices

For more information on VLANs, refer to IEEE Standard 802.1Q *Virtual Bridged Local Area Networks*. In this guide, see also:

- [Bulk Configuration in Chapter 22, Interfaces](#)
- [VLAN Stacking](#)

For a complete listing of all commands related to FTOS VLANs, see these *FTOS Command Reference* chapters:

- *Interfaces* chapter
- Port Authentication (802.1x) section in the *Security* chapter
- [Chapter 19, GARP VLAN Registration Protocol \(GVRP\)](#).
- [Chapter 43, Service Provider Bridging](#)
- [Chapter 37, Per-VLAN Spanning Tree Plus \(PVST+\)](#).
- For E-Series, see also the *ACL VLAN Group and Force10 Resilient Ring Protocol* chapters.

Table 52-1 displays the defaults for VLANs in FTOS.

Table 52-1. VLAN Defaults on FTOS

| Feature | Default |
|------------------------|---|
| Spanning Tree group ID | All VLANs are part of Spanning Tree group 0 |
| Mode | Layer 2 (no IP address is assigned) |
| Default VLAN ID | VLAN 1 |

Default VLAN

When interfaces are configured for Layer 2 mode, they are automatically placed in the Default VLAN as untagged interfaces. Only untagged interfaces can belong to the Default VLAN.

Figure 52-1 displays the outcome of placing an interface in Layer 2 mode. To configure an interface for Layer 2 mode, use the **switchport** command. In Step 1, the **switchport** command places the interface in Layer 2 mode.

In Step 2, the **show vlan** command in EXEC privilege mode indicates that the interface is now part of the Default VLAN (VLAN 1).

Figure 52-1. Interfaces and the Default VLAN Example

```

FTOS(conf)#int gi 3/2
FTOS(conf-if)#no shut
FTOS(conf-if)#switchport
FTOS(conf-if)#show config
!
interface GigabitEthernet 3/2
  no ip address
  switchport
  no shutdown
FTOS(conf-if)#end
FTOS#show vlan

Codes: * - Default VLAN, G - GVRP VLANs

  NUM      Status    Q Ports
*   1       Active    U Gi 3/2
   2       Active    T Po1(So 0/0-1)
                          T Gi 3/0
FTOS#

```

Step 1—the **switchport** command places the interface in Layer 2 mode

Step 2—the **show vlan** command indicates that the interface is now assigned to VLAN 1 (the * indicates the Default VLAN)

By default, VLAN 1 is the Default VLAN. To change that designation, use the **default vlan-id** command in the CONFIGURATION mode. You cannot delete the Default VLAN.



Note: An IP address cannot be assigned to the Default VLAN. To assign an IP address to a VLAN that is currently the Default VLAN, create another VLAN and assign it to be the Default VLAN. For details on assigning IP addresses, see [Assign an IP address to a VLAN](#).

Untagged interfaces must be part of a VLAN. To remove an untagged interface from the Default VLAN, you must create another VLAN and place the interface into that VLAN. Alternatively, enter the `no switchport` command, and FTOS removes the interface from the Default VLAN.

A tagged interface requires an additional step to remove it from Layer 2 mode. Since tagged interfaces can belong to multiple VLANs, you must remove the tagged interface from all VLANs, using the `no tagged interface` command. Only after the interface is untagged and a member of the Default VLAN can you use the `no switchport` command to remove the interface from Layer 2 mode. For more information, see [VLANs and Port Tagging](#).

Port-Based VLANs

Port-based VLANs are a broadcast domain defined by different ports or interfaces. In FTOS, a port-based VLAN can contain interfaces from different line cards within the chassis. FTOS supports 4094 port-based VLANs.



Note: E-Series ExaScale platforms support 4094 VLANs with FTOS version 8.2.1.0 and later. Earlier ExaScale supports 2094 VLANs.

Port-based VLANs offer increased security for traffic, conserve bandwidth, and allow switch segmentation. Interfaces in different VLANs do not communicate with each other, adding some security to the traffic on those interfaces. Different VLANs can communicate between each other by means of IP routing. Because traffic is only broadcast or flooded to the interfaces within a VLAN, the VLAN conserves bandwidth. Finally, you can have multiple VLANs configured on one switch, thus segmenting the device.

Interfaces within a port-based VLAN must be in Layer 2 mode and can be tagged or untagged in the VLAN ID.

VLANs and Port Tagging

To add an interface to a VLAN, it must be in Layer 2 mode. After you place an interface in Layer 2 mode, it is automatically placed in the Default VLAN. FTOS supports IEEE 802.1Q tagging at the interface level to filter traffic. When tagging is enabled, a tag header is added to the frame after the destination and source MAC addresses. That information is preserved as the frame moves through the network. [Figure 52-2](#) illustrates the structure of a frame with a tag header. The VLAN ID is inserted in the tag header.

Figure 52-2. Tagged Frame Format

Ethernet

| Preamble | Destination Address | Source Address | Tag Header | Protocol Type | Data | Frame Check Sequence |
|----------|---------------------|----------------|------------|---------------|------------------|----------------------|
| | 6 octets | 6 octets | 4 octets | 2 octets | 45 - 1500 octets | 4 octets |

FN00001B

The tag header contains some key information used by FTOS:

- The VLAN protocol identifier identifies the frame as tagged according to the IEEE 802.1Q specifications (2 bytes).
- Tag Control Information (TCI) includes the VLAN ID (2 bytes total). The VLAN ID can have 4,096 values, but 2 are reserved.



Note: The insertion of the tag header into the Ethernet frame increases the size of the frame to more than the 1518 bytes specified in the IEEE 802.3 standard. Some devices that are not compliant with IEEE 802.3 may not support the larger frame size.

Information contained in the tag header allows the system to prioritize traffic and to forward information to ports associated with a specific VLAN ID. Tagged interfaces can belong to multiple VLANs, while untagged interfaces can belong only to one VLAN.

Configuration Task List for VLANs

This section contains the following VLAN configuration tasks:

- [Create a port-based VLAN](#) (mandatory)
- [Assign interfaces to a VLAN](#) (optional)
- [Assign an IP address to a VLAN](#) (optional)
- [Enable Null VLAN as the Default VLAN](#)

Create a port-based VLAN

The Default VLAN as VLAN 1 is part of the system startup configuration and does not require configuration. To configure a port-based VLAN, you must create the VLAN and then add physical interfaces or port channel (LAG) interfaces to the VLAN.

To create a port-based VLAN, use the following command in the CONFIGURATION mode:

| Command Syntax | Command Mode | Purpose |
|--|---------------|---|
| <code>interface vlan <i>vlan-id</i></code> | CONFIGURATION | Configure a port-based VLAN (if the <i>vlan-id</i> is different from the Default VLAN ID) and enter INTERFACE VLAN mode. After you create a VLAN, you must assign interfaces in Layer 2 mode to the VLAN to activate the VLAN. |

Use the `show vlan` command (Figure 52-3) in the EXEC privilege mode to view the configured VLANs.

Figure 52-3. show vlan Command Example

```
FTOS#show vlan

Codes: * - Default VLAN, G - GVRP VLANs

  NUM   Status   Q Ports
*  1     Inactive  U So 9/4-11
  2     Active    U Gi 0/1,18
  3     Active    U Gi 0/2,19
  4     Active    T Gi 0/3,20
  5     Active    U Po 1
  6     Active    U Gi 0/12
                          U So 9/0

FTOS#
```

A VLAN is active only if the VLAN contains interfaces and those interfaces are operationally up. In Figure 52-3, VLAN 1 is inactive because it contains the interfaces that are not active. The other VLANs listed in the Figure 52-3 contain enabled interfaces and are active.



Note: In a VLAN, the shutdown command stops Layer 3 (routed) traffic only. Layer 2 traffic continues to pass through the VLAN. If the VLAN is not a routed VLAN (that is, configured with an IP address), the shutdown command has no effect on VLAN traffic.

When you delete a VLAN (using the `no interface vlan vlan-id` command), any interfaces assigned to that VLAN are assigned to the Default VLAN as untagged interfaces.

Assign interfaces to a VLAN

Only interfaces in Layer 2 mode can be assigned to a VLAN using the `tagged` and `untagged` commands. Use the `switchport` command to place an interface in Layer 2 mode.

These Layer 2 interfaces can further be designated as tagged or untagged. For more information, refer to the Interfaces chapter and [Configure Layer 2 \(Data Link\) Mode](#). When an interface is placed in Layer 2 mode by the `switchport` command, the interface is automatically designated untagged and placed in the Default VLAN.

To view which interfaces are tagged or untagged and to which VLAN they belong, use the `show vlan` command. For example, Figure 52-3 shows that six VLANs are configured, and two interfaces are assigned to VLAN 2. The Q column in the `show vlan` command example notes whether the interface is tagged (T) or untagged (U). For more information on this command, see the command statement in the Layer 2 chapter of the *FTOS Command Reference*.

To view just the interfaces that are in Layer 2 mode, enter the `show interfaces switchport` command in the EXEC privilege mode or EXEC mode.

To tag frames leaving an interface in Layer 2 mode, you must assign that interface to a port-based VLAN to tag it with that VLAN ID. To tag interfaces, use these commands in the following sequence:

| Step | Command Syntax | Command Mode | Purpose |
|------|--|---------------|---|
| 1 | <code>interface vlan <i>vlan-id</i></code> | CONFIGURATION | Access the INTERFACE VLAN mode of the VLAN to which you want to assign the interface. |
| 2 | <code>tagged <i>interface</i></code> | INTERFACE | Enable an interface to include the IEEE 802.1Q tag header. |

Figure 52-4 shows the steps to add a tagged interface (in this case, port channel 1) to VLAN 4.

Figure 52-4. Example of Adding an Interface to Another VLAN

```

FTOS#show vlan

Codes: * - Default VLAN, G - GVRP VLANs

  NUM   Status   Q Ports
*   1     Inactive
  2     Active   T Po1(So 0/0-1)
                        T Gi 3/0
  3     Active   T Po1(So 0/0-1)
                        T Gi 3/1

FTOS#config
FTOS(conf)#int vlan 4
FTOS(conf-if-vlan)#tagged po 1
FTOS(conf-if-vlan)#show conf
!
interface Vlan 4
  no ip address
  tagged Port-channel 1
FTOS(conf-if-vlan)#end
FTOS#show vlan

Codes: * - Default VLAN, G - GVRP VLANs

  NUM   Status   Q Ports
*   1     Inactive
  2     Active   T Po1(So 0/0-1)
                        T Gi 3/0
  3     Active   T Po1(So 0/0-1)
                        T Gi 3/1
  4     Active   T Po1(So 0/0-1)
FTOS#

```

Use the show vlan command to view the interface's status. Interface (po 1) is tagged and in VLAN 2 and 3

In a port-based VLAN, use the tagged command to add the interface to another VLAN.

The show vlan command output displays the interface's (po 1) changed status.

Except for hybrid ports, only a tagged interface can be a member of multiple VLANs. Hybrid ports can be assigned to two VLANs if the port is untagged in one VLAN and tagged in all others.

When you remove a tagged interface from a VLAN (using the `no tagged interface` command), it will remain tagged only if it is a tagged interface in another VLAN. If the tagged interface is removed from the only VLAN to which it belongs, the interface is placed in the Default VLAN as an untagged interface.

Use the untagged command to move untagged interfaces from the Default VLAN to another VLAN:

| Step | Command Syntax | Command Mode | Purpose |
|------|--|---------------|--|
| 1 | <code>interface vlan <i>vlan-id</i></code> | CONFIGURATION | Access the INTERFACE VLAN mode of the VLAN to which you want to assign the interface. |
| 2 | <code>untagged <i>interface</i></code> | INTERFACE | Configure an interface as untagged. This command is available only in VLAN interfaces. |

The `no untagged interface` command removes the untagged interface from a port-based VLAN and places the interface in the Default VLAN. You cannot use the `no untagged interface` command in the Default VLAN. Figure 52-5 illustrates the steps and commands to move an untagged interface from the Default VLAN to another VLAN.

Figure 52-5. Example of Moving an Untagged Interface to Another VLAN

```

FTOS#show vlan
Codes: * - Default VLAN, G - GVRP VLANs

  NUM    Status    Q Ports
*   1     Active    U Gi 3/2
   2     Active    T Pol(So 0/0-1)
                        T Gi 3/0
   3     Active    T Pol(So 0/0-1)
                        T Gi 3/1
   4     Inactive

FTOS#conf
FTOS(conf)#int vlan 4
FTOS(conf-if-vlan)#untagged gi 3/2
FTOS(conf-if-vlan)#show config
!
interface Vlan 4
 no ip address
 untagged GigabitEthernet 3/2
FTOS(conf-if-vlan)#end
FTOS#show vlan

Codes: * - Default VLAN, G - GVRP VLANs

  NUM    Status    Q Ports
*   1     Inactive
   2     Active    T Pol(So 0/0-1)
                        T Gi 3/0
   3     Active    T Pol(So 0/0-1)
                        T Gi 3/1
   4     Active    U Gi 3/2
FTOS#
  
```

Use the `show vlan` command to determine interface status. Interface (gi 3/2) is untagged and in the Default VLAN (vlan 1).

In a port-based VLAN (vlan 4), use the `untagged` command to add the interface to that VLAN.

The `show vlan` command output displays the interface's changed status (gi 3/2). Since the Default VLAN no longer contains any interfaces, it is listed as inactive.

The only way to remove an interface from the Default VLAN is to place the interface in Default mode by entering the `no switchport` command in the INTERFACE mode.

Assign an IP address to a VLAN

VLANs are a Layer 2 feature. For two physical interfaces on different VLANs to communicate, you must assign an IP address to the VLANs to route traffic between the two interfaces.

The shutdown command in INTERFACE mode does not affect Layer 2 traffic on the interface; the shutdown command only prevents Layer 3 traffic from traversing over the interface.



Note: An IP address cannot be assigned to the Default VLAN, which, by default, is VLAN 1. To assign another VLAN ID to the Default VLAN, use the `default vlan-id vlan-id` command.

To assign an IP address, use the following command in INTERFACE mode:

| Command Syntax | Command Mode | Purpose |
|--|--------------|--|
| <code>ip address <i>ip-address mask</i> [secondary]</code> | INTERFACE | Configure an IP address and mask on the interface. <ul style="list-style-type: none"> <i>ip-address mask</i> — Enter an address in dotted-decimal format (A.B.C.D) and the mask must be in slash format (/24). <i>secondary</i> — This is the interface's backup IP address. You can configure up to eight secondary IP addresses. |

In FTOS, VLANs and other logical interfaces can be placed in Layer 3 mode to receive and send routed traffic. For details, see [Bulk Configuration](#).

VLAN Interface Counters

VLAN counters can be enabled for either Ingress packets, egress packets, or both. VLAN counters are disabled by default, and are supported on E-Series ExaScale $\text{E} \times$ only.

| Command Syntax | Command Mode | Purpose |
|---|---------------|---|
| <code>enable vlan-counter [ingress egress all]</code> | CONFIGURATION | Configure ingress, egress or both counters for VLAN interfaces. |

To return to the default without any VLAN counters, enter `no enable vlan-counter`.



Note: VLAN output counters may show higher than expected values because source-suppression drops are counted.

Native VLANs

Traditionally, ports can be either untagged for membership to one VLAN or tagged for membership to multiple VLANs. An untagged port must be connected to a VLAN-unaware station (one that does not understand VLAN tags), and a tagged port must be connected to a VLAN-aware station (one that generates and understands VLAN tags).

Native VLAN support breaks this barrier so that a port can be connected to both VLAN-aware and VLAN-unaware stations. Such ports are referred to as *hybrid ports*. Physical and port-channel interfaces may be hybrid ports.

Native VLAN is useful in deployments where a Layer 2 port can receive both tagged and untagged traffic on the same physical port. The classic example is connecting a VOIP phone and a PC to the same port of the switch. The VOIP phone is configured to generate tagged packets (with VLAN = VOICE VLAN), and the attached PC generates untagged packets.

To configure a port so that it can be a member of an untagged and tagged VLANs:

| Step | Task | Command | Command Mode |
|------|--|---------------------|----------------|
| 1 | Remove any Layer 2 or Layer 3 configurations from the interface. | | INTERFACE |
| 2 | Configure the interface for hybrid mode. | portmode hybrid | INTERFACE |
| 3 | Configure the interface for switchport mode. | switchport | INTERFACE |
| 4 | Add the interface to a tagged or untagged VLAN. | [tagged untagged] | VLAN INTERFACE |



Note: An existing switchport or port channel interface cannot be configured for Native VLAN. Interfaces must have no other Layer 2 or Layer 3 configurations when entering the command portmode hybrid or a message like [Message 1](#) is displayed.

Message 1 Native VLAN Error

```
% Error: Port is in Layer-2 mode Gi 5/6.
```

Enable Null VLAN as the Default VLAN

In a Carrier Ethernet for Metro Service environment, service providers who perform frequent reconfigurations for customers with changing requirements occasionally enable multiple interfaces, each connected to a different customer, before the interfaces are fully configured. This presents a vulnerability because both interfaces are initially placed in the native VLAN, VLAN 1, and for that period customers are able to access each other's networks. FTOS has a Null VLAN to eliminate this vulnerability. When you enable the Null VLAN, all ports are placed into by it default, so that even if you activate the physical ports of multiple customers, no traffic is allowed to traverse the links until each port is place in another VLAN.

| Task | Command Syntax | Command Mode |
|---|---|---------------|
| Disable the default VLAN, so that all ports belong to the Null VLAN until configured as a member of another VLAN. | default-vlan disable Default: the default VLAN is enabled (no default-vlan disable). | CONFIGURATION |

Virtual Link Trunking (VLT)

Virtual Link Trunking (VLT) is supported on the **S4810** and **S4820T** platform.

Overview

Virtual link trunking (VLT) allows physical links between two chassis to appear as a single virtual link to the network core or other switches such as Edge, Access or ToR. VLT reduces the role of Spanning Tree protocols by allowing LAG terminations on two separate distribution or core switches, and by supporting a loop free topology. (A Spanning Tree protocol is still needed to prevent the initial loop that may occur prior to VLT being established. After VLT is established, RSTP may be used to prevent loops from forming with new links that are incorrectly connected and outside the VLT domain.) VLT provides Layer 2 multipathing, creating redundancy through increased bandwidth, enabling multiple parallel paths between nodes and load-balancing traffic where alternative paths exist.

Virtual link trunking offers the following benefits:

- Allows a single device to use a LAG across two upstream devices
- Eliminates Spanning Tree Protocol (STP) blocked ports
- Provides a loop-free topology
- Uses all available uplink bandwidth
- Provides fast convergence if either the link or a device fails
- Optimized forwarding with VRRP
- Provides link-level resiliency
- Assures high availability



Caution: Dell Force10 recommends not enabling Stacking and VLT simultaneously. If both are enabled at the same time, unexpected behavior will occur.

As shown in the following figure, VLT presents a single logical Layer 2 domain from the perspective of attached devices that have a virtual link trunk terminating on separate chassis in the VLT domain. However, the two VLT chassis are independent Layer2/Layer3 (L2/L3) switches for devices in the upstream network. L2/L3 control plane protocols and system management features function normally in VLT mode. Features such as VRRP and IGMP Snooping require state information to be coordinated between the two VLT chassis. IGMP and VLT configurations must be identical on both sides of the trunk to ensure the same behavior on both sides.

This figure shows VLT deployed on S4810 switches. The S4810 switches appear as a single virtual switch from the point of view of the switch or server supporting LACP.

Note: The S4810 is shown in the illustration, but it also applies to the S4820T.

Figure 53-1. Virtual Link Trunking on S4810 (or S4820T) Switches

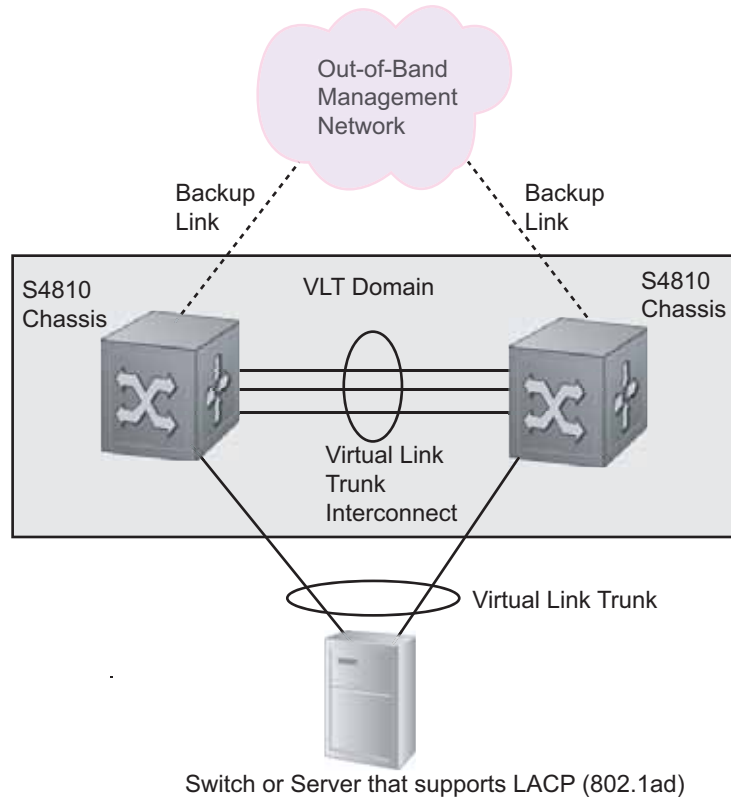

VLT on Core Switches

VLT can also be deployed on core switches. Uplinks from servers to the access layer and from access layer to the aggregation layer are bundled in LAG groups with end-to-end Layer 2 multipathing. This requires “horizontal” stacking at the access layer and VLT at the aggregation layer such that all the uplinks from servers to access and access to aggregation are in active-active load sharing mode. This example provides the highest form of resiliency, scaling and load balancing in data center switching networks.

The following figure shows stacking at the access, VLT in aggregation, and Layer 3 at the core.

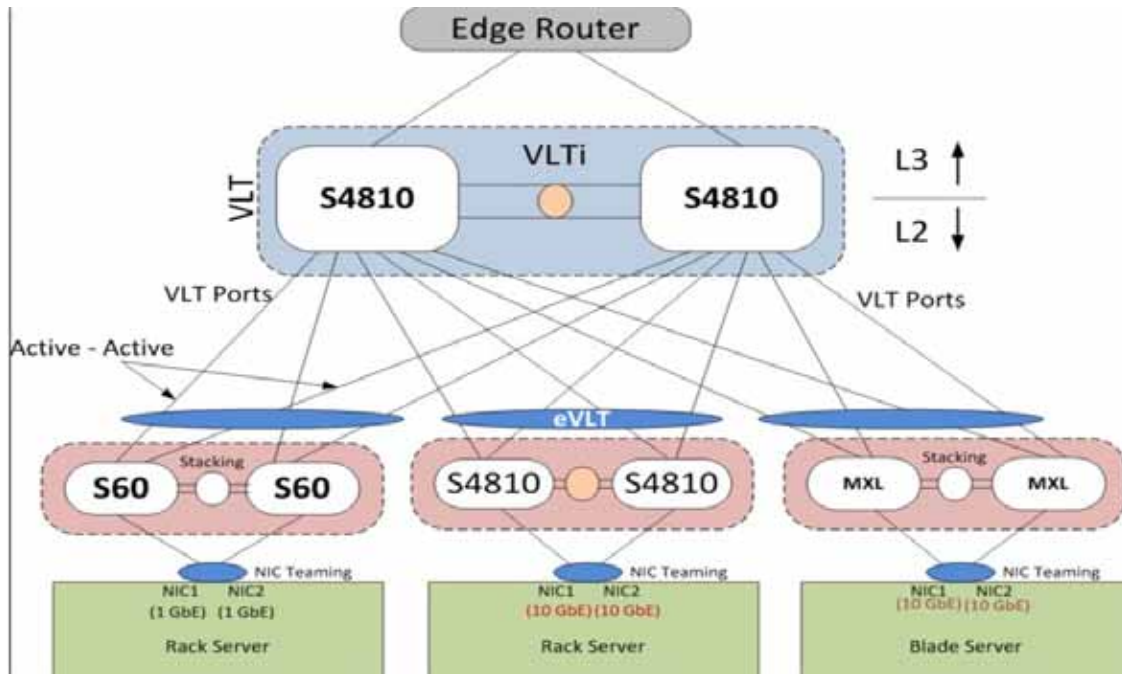

The aggregation layer is mostly in the L2/L3 switching/routing layer. For better resiliency in the aggregation, Dell Force10 recommends running the Internal Gateway Protocol on the VLTi VLAN to synchronize the L3 routing table across the two nodes on a VLT system.

Enhanced VLT

An enhanced VLT (eVLT) configuration allows two different VLT domains connected by a standard LACP LAG to form a loop free Layer 2 topology in the aggregation layer. This configuration supports a maximum of four (4) units, increasing the number of available ports and allowing for dual redundancy of the VLT. The following figure shows how the core/aggregation port density in the Layer 2 topology is increased using eVLT. For inter-VLAN routing and other Layer 3 routing, a separate Layer 3 router is required.

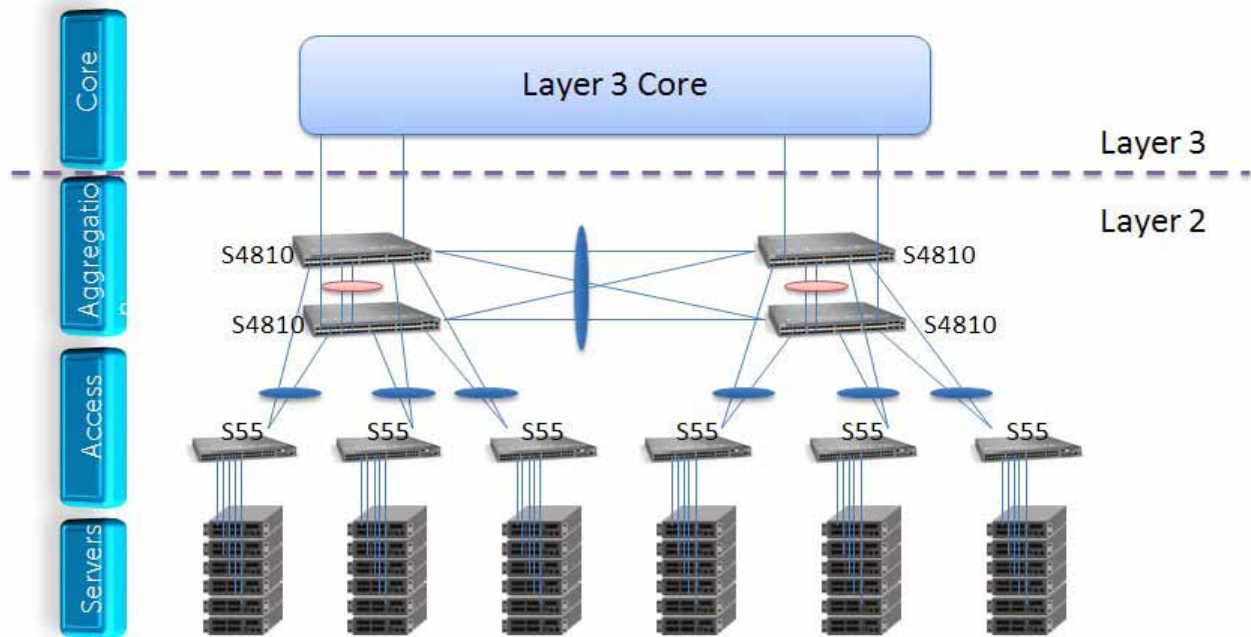

VLT Terminology

The following are some key VLT terms.

Virtual link trunk (VLT) - The combined port channel between an attached device and the VLT peer switches.

VLT backup link - The backup link monitors the vitality of a VLT peer switches. The backup link sends configurable, periodic keep alive messages between VLT peer switches.

VLT interconnect (VLTi) - The link used to synchronize states between the VLT peer switches. Both ends must be on 10G or 40G interfaces.

VLT domain - This domain includes both VLT peer devices, the VLT interconnect, and all of the port channels in the VLT connected to the attached devices. It is also associated to the configuration mode that must be used to assign VLT global parameters.

VLT peer device - One of a pair of devices that are connected with the special port channel known as the VLT interconnect (VLTi).

VLT peer switches have independent management planes. A VLT interconnect between the VLT chassis maintains synchronization of L2/L3 control planes across the two VLT peer switches. The VLT interconnect uses either 10G or 40G user ports on the chassis.

A separate backup link maintains heartbeat messages across an out-of-band management network. The backup link ensures that node failure conditions are correctly detected and are not confused with failures of the VLT interconnect. VLT ensures that local traffic on a chassis does not traverse the VLTi and takes the shortest path to the destination via directly attached links.

Configuring Virtual Link Trunking

VLT requires that you enable the feature and then configure the same VLT domain, backup link, and VLT interconnect on both peer switches.

Important Points to Remember

- Stacking cannot be enabled simultaneously with VLT. If both are enabled at the same time, unexpected behavior will occur. See [VLT and Stacking](#).
- VLT port channel interfaces must be switch ports.
- If RSTP is included on the system, it must be configured before VLT. See [RSTP Configuration](#).
- Dell Force10 strongly recommends that the VLTi (VLT interconnect) must be a static LAG and that LACP should be disabled on the VLTi.
- The spanning tree root bridge should be at the Aggregation layer. If RSTP is enabled on the VLT device, refer to [RSTP and VLT](#) for guidelines to avoid traffic loss.
- If both VLT peers are rebooted in JumpStart mode and VLT LAGs are static, the DHCP server reply to the DHCP discover offer may not be forwarded by the ToR to the correct node. To avoid this scenario, configure the VLT LAGs to the ToR and the ToR port channel to the VLT peers with LACP. If supported by the ToR, enable the **lACP-ungroup** feature on the ToR using the command **lACP ungroup member-independent port-channel**.
- If the **lACP-ungroup** feature is not supported on the ToR, VLT peers should be rebooted one at a time. After rebooting, verify that VLTi (ICL) is active before attempting DHCP connectivity.
- When IGMP snooping is enabled on the VLT peers, ensure the value of the **delay-restore** command is not less than the query interval.
- When Layer 3 routing protocols are enabled on VLT peers, make sure the **delay-restore** timer is set to a value that allows sufficient time for all routes to establish adjacency and exchange all the L3 routes between the VLT peers sr before the VLT ports are enabled.
- The **lACP ungroup member-independent** command should only be used if the system connects to nodes using BMP to upgrade or boot from the network.
- Ensure all port channels where LACP ungroup is applicable are configured as hybrid ports and as untagged members of a VLAN. BMP uses untagged DHCP packets to communicate with the DHCP server.

- If the DHCP server is located on the ToR and the VLTi (ICL) is down due to a failed link when a VLT node is rebooted in JumpStart mode, it will not be able to reach the DHCP server, resulting in BMP failure.

Configuration Notes

When you configure VLT, the following conditions apply:

- **VLT domain**
 - A VLT domain supports two chassis members, which appear as a single logical device to network access devices connected to VLT ports through a port channel.
 - A VLT domain consists of the two core chassis, the interconnect trunk, backup link, and the LAG members connected to attached devices.
 - Each VLT domain has a unique MAC address that is created automatically by VLT or user-configured.
 - ARP tables are synchronized between the VLT peer nodes.
 - VLT peer switches operate as separate chassis with independent control and data planes for devices attached on non-VLT ports.
 - One chassis in the VLT domain is assigned a primary role; the other chassis takes the secondary role. The primary and secondary roles are required for scenarios when connectivity between the chassis is lost. VLT assigns the primary chassis role according to the lowest MAC address. The primary role is also user-configurable.
 - In a VLT domain, the peer switches must run the same FTOS software version
 - You must separately configure each VLT peer switch with the same VLT domain ID and the VLT version. If the system detects mismatches between VLT peer switches in the VLT domain ID or VLT version, the VLT Interconnect (VLTi) will not activate. To find the reason for the VLTi being down, use the **show vlt statistics** command to verify there are mismatch errors, then use the **show vlt brief** command on each VLT peer to view the VLT version on the peer switch. If the VLT version is more than one release different from the current version in use, the VLTi will not activate.
 - The chassis members in a VLT domain support connection to orphan hosts and switches that are not connected to both switches in the VLT core.
- **VLT interconnect (VLTi)**
 - The VLT interconnect must consist of either 10G or 40G ports. A maximum of eight 10G or four 40G ports is supported. A combination of 10G and 40G ports is not supported.
 - A VLT interconnect over 1G ports is *not* supported.
 - The port channel must be in default mode (not switchport) to be recognized by VLTi.
 - The system will automatically include required VLANs in VLTi. You do not need to manually select VLANs.
 - VLT peer switches operate as separate chassis with independent control and data planes for devices attached on non-VLT ports.
 - Port-channel link aggregation (LAG) across the ports in the VLT interconnect is required; individual ports are not supported. Dell Force10 strongly recommends configuring a static LAG for VLTi.
 - The VLT interconnect synchronizes L2 and L3 control-plane information across the two chassis.

- The VLT interconnect is used for data traffic only when there is a link failure that requires the VLTi to be used in order for data packets to reach their final destination.
- Unknown, multicast and broadcast traffic can be flooded across the VLT interconnect.
- MAC addresses for VLANs configured across VLT peer chassis are synchronized over the VLT interconnect on an egress port such as a VLT LAG. MAC addresses are the same on both VLT peer nodes.
- ARP entries configured across the VLTi are the same on both VLT peer nodes.
- If you shut down the port channel used in the VLT interconnect on a peer switch in a VLT domain in which no backup link is configured, the switch's role is displayed in **show vlt brief** command output as Primary instead of Standalone.
- When you change the default VLAN ID on a VLT peer switch, the VLT interconnect may flap.
- In a VLT domain, the following software features are supported on VLTi: LLDP, flow control, port monitoring, jumbo frames, DCB.
- When the VLTi link is enabled, the link between the VLT peer switches is established if the following configured information is true on *both* peer switches:
 - the VLT system MAC address matches.
 - the VLT unit-id is not identical.



Note: If the VLT system MAC address or VLT unit-id is configured on only one of the VLT peer switches, the link between the VLT peer switches will not be established. Each VLT peer switch must be correctly configured to establish the link between the peers.

- If the link between the VLT peer switches is established, changing the VLT system MAC address or the VLT unit-id will *not* cause the link between the VLT peer switches to become disabled. However, removing the VLT system MAC address or the VLT unit-id may cause the VLT ports to be disabled if the unit ID or system MAC address happens to be configured on only one VLT peer at any time.
- If the link between VLT peer switches is established, any change to the VLT system MAC address or unit-id will fail if the changes made create a mismatch by causing the VLT unit-ID to be the same on both peers and/or the VLT system MAC address does not match on both peers.
- If you replace a VLT peer node, pre-configure the switch with the VLT system MAC address, unit-id, and other VLT parameters before connecting it to the existing VLT peer switch using the VLTi connection.
- **VLT backup link**
 - In the backup link between peer switches, heartbeat messages are exchanged between the two chassis for health checks. The default time interval between heartbeat messages over the backup link is 1 second. This interval is user-configurable; range: 1 to 5 seconds. DSCP marking on heartbeat messages is CS6.
 - In order that the chassis backup link does not share the same physical path as the interconnect trunk, it is recommended that you use the management ports on the chassis and traverse an out-of-band management network. The backup link can use user ports, but not the same ports as used by the interconnect trunk.
 - The chassis backup link does not carry control plane information or data traffic. Its use is restricted to health checks only.

- **Virtual link trunks (VLTs) between access devices and VLT peer switches:**
 - To connect servers and access switches with VLT peer switches, you use a VLT port channel (see [Figure 53-1](#)). Up to 48 port-channels are supported; up to 8 member links are supported in each port channel between the VLT domain and an access device.
 - The ID number of the port channel that connects an access device and a VLT switch is automatically generated by the discovery protocol running between VLT peers. The discovery protocol uses LACP properties to identify connectivity to a common client device and automatically generate a VLT number for port channels on VLT peers that connect to the device. The discovery protocol requires that an attached device should always run LACP over the port-channel interface.
 - VLT provides a loop-free topology for port channels with endpoints on different chassis in the VLT domain.
 - VLT uses shortest path routing so that traffic destined to hosts via directly attached links on a chassis does not traverse the chassis-interconnect link.
 - VLT allows multiple active parallel paths from access switches to VLT chassis.
 - VLT supports port-channel links with LACP between access switches and VLT peer switches. Dell Force10 recommends that you use static port channels on VLTi.
 - If VLTi connectivity with a peer is lost but the VLT backup connectivity indicates the peer is still alive, the VLT ports on the Secondary peer are orphaned and will be shut down.
 - In one possible topology, a switch uses the Jumpstart (BMP) feature to receive its IP address, configuration files, and boot image from a DHCP server that connects to the switch through the VLT domain. In the port-channel used by the switch to connect to the VLT domain, you must configure the port interfaces on each VLT peer as hybrid ports before adding them to the port channel (see [Connect a VLT domain to an attached access device \(switch or server\)](#)). To configure a port in hybrid mode so that it can carry untagged, single-tagged, and double-tagged traffic, enter the **portmode hybrid** command in interface configuration mode as described in [Native VLANs](#).
 - For example, if the DHCP server is located on the ToR and VLTi (ICL) is down (due to either an unavailable peer or a link failure), whether the VLT LAG is configured as static or LACP, when a single VLT peer is rebooted in JumpStart mode, it will not be able to reach the DHCP server, resulting in BMP failure.
- **Software features supported on VLT ports:**
 - In a VLT domain, the following software features are supported on VLT ports: VRRP, Layer 3 VLANs, IGMP Snooping, FRRP, DHCP Snooping, DHCP relay, sFlow, ingress and egress QoS, ingress and egress ACLs, DCB and Layer 2 control protocols such as RSTP (see [RSTP Configuration](#)).



Note: PVST+ passthrough is supported in a VLT domain. PVST+ BPDUs will not result in an interface shutdown. PVST+ BPDUs for a non-default VLAN will be flooded out as any other L2 multicast packet. On a default VLAN, RTSP will be part of the PVST+ topology in that specific VLAN (default VLAN).

- Refer to [VLT and VRRP interoperability](#): for detailed information on how to use VRRP in a VLT domain.
- Refer to [VLT and IGMP Snooping](#) for information on configuring IGMP Snooping in a VLT domain.
- All system management protocols are supported on VLT ports, including SNMP, RMON, AAA, ACL, DNS, FTP, SSH, Syslog, NTP, RADIUS, SCP, TACACS+, Telnet, and LLDP.

- Layer 3 VLAN connectivity VLT peers is enabled by configuring a VLAN network interface for the same VLAN on both switches.
- **Software features supported on VLT port-channels:**
 - In a VLT domain, the following software features are supported on VLT port-channels: 802.1p, LLDP, flow control, port monitoring, jumbo frames.
- **Software features supported on non-VLT ports:**
 - In a VLT domain, the following software features are supported on non-VLT ports: OSPF, BGP, IS-IS, DHCP relay, sFlow, ingress and egress QOS, ingress and egress ACLs, 802.1x, and all protocols currently supported in FTOS.
- **VLT and VRRP interoperability:**
 - In a VLT domain, VRRP interoperates with virtual link trunks that carry traffic to and from access devices (see [Figure 53-1](#)). The VLT peers belong to the same VRRP group and are assigned master and backup roles. Each peer actively forwards L3 traffic, reducing the traffic flow over the VLT interconnect.
 - VRRP elects the router with the highest priority as the master in the VRRP group. To ensure VRRP operation in a VLT domain, you must configure VRRP group priority on each VLT peer so that a peer is either the master or backup for *all* VRRP groups configured on its interfaces. See [Set VRRP Group \(Virtual Router\) Priority](#) for more information.
 - To verify that a VLT peer is consistently configured for either the master or backup role in *all* VRRP groups, enter the **show vrrp** command on each peer.
 - You must also configure the same L3 routing (static and dynamic) on each peer so that L3 reachability and routing tables are identical on both VLT peers. Both the VRRP master and backup peers should be able to locally forward L3 traffic in the same way.
 - In a VLT domain, although both VLT peers actively participate in L3 forwarding as the VRRP master or backup router, the **show vrrp** command output displays one peer as master and the other peer as backup.
- **Failure scenarios:**
 - On a link failover, when a VLT port channel fails, the traffic destined for that VLT port channel is re-directed to the VLTi to avoid flooding.
 - When a VLT switch determines that a VLT port channel has failed (and that no other local port channels are available), the peer with the failed port channel notifies the remote peer that it no longer has an active port channel for a link. The remote peer then enables data forwarding across the interconnect trunk for packets that would otherwise have been forwarded over the failed port channel. This mechanism ensures reachability and provides loop management. If the VLT interconnect fails, the VLT software on the primary switch checks the status of the remote peer using the backup link. If the remote peer is up, the secondary switch disables all VLT ports on its device to prevent loops.
 - If all ports in the VLT interconnect fail, or if the messaging infrastructure fails to communicate across the interconnect trunk, the VLT management system uses the backup link interface to determine whether the failure is a link-level failure or whether in fact the remote peer has failed entirely. If the remote peer is still alive (heartbeat messages are still being received), the VLT secondary switch disables its VLT port channels. If keepalive messages from the peer are not being received, the peer continues to forward traffic, assuming that it is the last device available in the network. In either case, upon recovery of the peer link or reestablishment of message forwarding across the interconnect trunk, the two VLT peers resynchronize any MAC addresses learned while communication was interrupted, and the VLT system continues normal data forwarding.

- If the primary chassis fails, the secondary chassis takes on the operational role of the primary.
- The SNMP MIB reports VLT statistics.

RSTP and VLT

VLT provides loop-free redundant topologies and does not require rapid spanning tree protocol (RSTP). RSTP can cause temporary port state blocking and may cause topology changes after link or node failures. Spanning tree topology changes are distributed to the entire layer 2 network, which can cause a network-wide flush of learned MAC and ARP addresses, requiring these addresses to be re-learned. However, enabling RSTP can detect potential loops caused by non-system issues such as cabling errors or incorrect configurations. RSTP is useful for potential loop detection but should be configured using the specifications below to minimize possible topology changes after link or node failure.

The following recommendations will help you avoid these issues and the associated traffic loss caused by using rapid spanning trees when VLT is enabled on both VLT peers:

- Any ports at the edge of the spanning tree's operating domain should be configured as edge ports, which are directly connected to end stations or server racks. Ports connected directly to layer 3-only routers not running STP should have RSTP disabled or be configured as edge ports.
- Ensure the primary VLT node is the root bridge and the secondary VLT peer node has the second-best bridge ID in the network. If the primary VLT peer node fails, the secondary VLT peer node becomes the root bridge, avoiding problems with spanning tree port state changes that occur when a VLT node fails or recovers.
- Even with this configuration, if the node has non-VLT ports using RSTP that are not configured as edge ports and are connected to other layer 2 switches, spanning tree topology changes can still be detected after VLT node recovery. To avoid this scenario, ensure that any non-VLT ports are configured as edge ports or have RSTP disabled.

VLT Bandwidth Monitoring

When bandwidth usage of the VLTi (ICL) exceeds 80%, a syslog error message ([Message 1](#)) and an SNMP trap are generated.

Message 1 VLTi Bandwidth Usage Exceeding Threshold Value Error

```
%STKUNIT0-M:CP %VLTMGR-6-VLT-LAG-ICL: Overall Bandwidth utilization of VLT-ICL-LAG (port-channel 25)
crosses threshold. Bandwidth usage (80 )
```

When the bandwidth usage drops below the 80% threshold, the system generates another syslog message ([Message 2](#)) and an SNMP trap.

Message 2 Excessive VLTi Bandwidth Usage Drops Below Threshold Value Error

```
%STKUNIT0-M:CP %VLTMGR-6-VLT-LAG-ICL: Overall Bandwidth utilization of VLT-ICL-LAG (port-channel 25)
reaches below threshold. Bandwidth usage (74 )VLT show remote port channel status
```

VLT and Stacking

Stacking S4810 or S4820T units cannot be enabled with VLT. If stacking is currently enabled on a unit on which you want to enable VLT, you must first remove the unit from the existing stack. For information on how to remove a unit from a stack, see [Chapter 46, Stacking, Remove a Unit from an S-Series Stack on page 937](#). After the unit has been removed, VLT can be configured on the unit.

VLT and IGMP Snooping

When configuring IGMP Snooping with VLT, you must ensure the configurations on both sides of the VLT trunk are identical to get the same behavior on both sides of the trunk. When IGMP Snooping is configured on a VLT node, the dynamically learned groups and multicast router ports are automatically learned on the VLT peer node.

VLT Port Delayed Restoration

With FTOS Release 8.3.12.0, when a VLT node boots up, if the VLT ports have been previously saved in the start-up configuration, they will not be immediately enabled. To ensure MAC and ARP entries from the VLT per node are downloaded to the newly enabled VLT node, the system allows time for the VLT ports on the new node to be enabled and begin receiving traffic.

The **delay-restore** feature waits for all saved configurations to be applied, then starts a configurable timer. After the timer expires, the VLT ports are enabled one-by-one in a controlled manner. The delay between bringing up each VLT port-channel is proportional to the number of physical members in the port-channel.

Use the **delay-restore** command to change the duration of the configurable timer; the default is 90 seconds.

If IGMP Snooping is enabled, IGMP queries are also sent out on the VLT ports at this time allowing any receivers to respond to the queries and update the multicast table on the new node.

This delay in bringing up the VLT ports also applies when the VLTi link recovers from a failure that caused the VLT ports on the secondary VLT peer node to be disabled.

PIM-Sparse Mode Support on VLT

The Designated Router functionality of the PIM Sparse-Mode multicast protocol is supported on VLT peer switches for multicast sources and receivers that are connected to VLT ports. The VLT peer switches can act as a last-hop router for IGMP receivers and as a first-hop router for multicast sources.

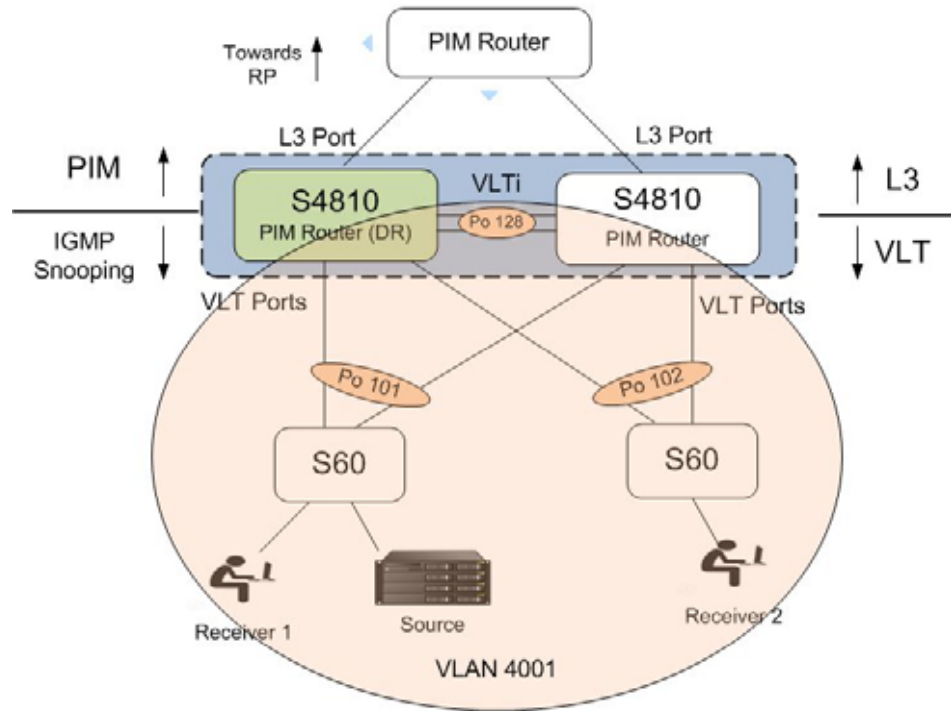

On each VLAN where the VLT peer nodes act as the first hop or last hop routers, one of the VLT peer nodes will be elected as the PIM Designated Router. If IGMP Snooping is configured along with PIM on the VLT VLANs, then VLTi must be configured as the static multicast router port on both VLT peer switches. This allows multicast traffic that originates from the source that is connected to the VLT ports to reach the PIM router which has downstream neighbors.

The VLT peer nodes can also act as normal PIM routers on Layer 3 ports and on VLANs that do not have any VLT port members. In addition to being first-hop or last-hop routers, the peer node can also act as an intermediate router.

To route traffic to and from the multicast source and receiver that are connected to VLT ports, enable PIM-Sparse mode on the VLANs to which the VLT ports belong using the **ip pim sparse-mode** command. If IGMP Snooping is configured on these VLANs, the VLTi must be configured as a static multicast router port on both VLT peers.

Use the **show ip pim neighbor**, **show ip igmp snooping mrouter**, and **show running config** commands to verify the PIM neighbors on the VLT VLAN and on the multicast port:

VLT peer nodes cannot be configured rendezvous points, PIM routers cannot be connected to VLT ports; you must use a different port.

If the VLT node elected as the designated router fails, traffic loss will occur until another VLT node is elected the designated router.

RSTP Configuration

The RSTP Spanning Tree protocol is supported in a VLT domain. Before you configure VLT on peer switches, you must configure the Rapid Spanning Tree Protocol (RSTP) in the network if it will be included in your configuration. RSTP is required for initial loop prevention during the VLT startup phase. RSTP may also be used for loop prevention in the network outside of the VLT port channel. For information on how to configure RSTP, see [Chapter 41, “Rapid Spanning Tree Protocol \(RSTP\),” on page 805](#).

RSTP must be running on both VLT peer switches. The primary VLT peer controls RSTP states, such as forwarding and blocking, on both the primary and secondary peers. It is recommended that you configure the primary VLT peer as the RSTP primary root device and configure the secondary VLT peer as the RSTP secondary root device.

BPDU use the MAC address of the primary VLT peer as the RSTP bridge ID in the designated bridge ID field. The primary VLT peer sends these BPDUs on VLT interfaces connected to access devices. The MAC address for a VLT domain is automatically selected on the peer switches when you create the domain (refer to *Enable VLT and create a VLT domain*).

You must configure both ends of the VLT interconnect trunk with identical RSTP configurations. When VLT is enabled, the **show spanning-tree rstp brief** command output displays VLT information (see [Figure 53-10](#)).

Preventing Forwarding Loops in a VLT Domain

During the bootup of VLT peer switches, a forwarding loop may occur until the VLT configurations are applied on each switch and the primary/secondary roles are determined. To prevent the interfaces in the VLT interconnect trunk and RSTP-enabled VLT ports from entering a forwarding state and creating a traffic loop in a VLT domain, you must take the following steps:

| Step | Task | Command Syntax | Command Mode |
|------|---|------------------------|-----------------------------------|
| 1 | Configure RSTP in the core network and on each peer switch as described in Chapter 41, Rapid Spanning Tree Protocol (RSTP) . Disabling RSTP on one VLT peer may result in a VLT domain failure. | | |
| 2 | Enable RSTP on each peer switch. | no disable | PROTOCOL SPANNING TREE RSTP |
| 3 | Configure each peer switch with a unique bridge priority. | bridge-priority | PROTOCOL SPANNING TREE RSTP |

Sample RSTP Configuration

Using [Figure 53-1](#) as a sample VLT topology, the primary VLT switch will send BPDUs to an access device (switch or server) with its own RSTP bridge ID. BPDUs generated by an RSTP-enabled access device are only processed by the primary VLT switch. The secondary VLT switch tunnels the BPDUs that it receives to the primary VLT switch over the VLT interconnect. Only the primary VLT switch determines the RSTP roles and states on VLT ports, and ensures that the VLT interconnect link is never blocked.

In case of a primary VLT switch failure, the secondary switch starts sending BPDUs with its own bridge ID and inherits all the port states from the last synchronization with the primary switch. An access device never detects the change in primary/secondary roles and does not see it as a topology change.

The following figures show an example of the RSTP configuration that you must perform on each peer switch to prevent forwarding loops.

Figure 53-2. Configuring RSTP on VLT Peers to Prevent Forwarding Loops (VLT Peer 1)

```
FTOS_VLTpeer1(conf)#protocol spanning-tree rstp
FTOS_VLTpeer1(conf-rstp)#no disable
FTOS_VLTpeer1(conf-rstp)#bridge-priority 4096
```

Figure 53-3. Configuring RSTP on VLT Peers to Prevent Forwarding Loops (VLT Peer 2)

```
FTOS_VLTpeer2(conf)#protocol spanning-tree rstp
FTOS_VLTpeer2(conf-rstp)#no disable
FTOS_VLTpeer2(conf-rstp)#bridge-priority 0
```

VLT Configuration Procedure

Prerequisites: Before you begin, make sure that both VLT peer switches are running the same FTOS version and are configured for RSTP as described in [RSTP Configuration](#). For VRRP operation, ensure that VRRP groups and L3 routing on each VLT peer are configured as described in [VLT and VRRP interoperability](#).

To configure virtual link trunking and create a VLT domain in which two switches are physically connected and treated as a single port channel by access devices, you must configure the following settings on each VLT peer device:

1. Configure the VLT interconnect for the VLT domain. The primary and secondary switch roles in the VLT domain are automatically assigned after both sides of the VLTi are configured.



Note: If a third-party ToR unit is used, Dell Force10 recommends using static LAGs on the VLTi between VLT peers to avoid potential problems if the VLT peers are rebooted.

2. Enable VLT and create a VLT domain ID. VLT automatically selects a system MAC address.
3. Configure a backup link for the VLT domain.
4. (Optional) Manually reconfigure default VLT settings, such as MAC address and VLT primary/secondary roles.

- Connect the peer switches in a VLT domain to an attached access device (switch or server).

Configure a VLT interconnect

| Step | Task | Command Syntax | Command Mode |
|---|---|---|---------------------------|
| 1 | Configure the port channel to be used for the VLT interconnect on a VLT switch and enter interface configuration mode. Enter the same port-channel number configured with the peer-link port-channel command in the Enable VLT and Create a VLT Domain steps. | interface port-channel <i>id-number</i> | CONFIGURATION |
| Note: To be included in the VLTi, the port channel must be in default mode (no switchport or VLAN assigned). | | | |
| 2 | Remove an IP address from the interface. | no ip address | INTERFACE PORT-CHANNEL |
| 3 | Add one or more port interfaces to the port channel. <i>interface</i> specifies one of the following interface types: 1-Gigabit Ethernet: Enter gigabitethernet slot/port . 10-Gigabit Ethernet: Enter tengigabitethernet slot/port . | channel-member <i>interface</i> | INTERFACE PORT-CHANNEL |
| 4 | Ensure that the port channel is active. | no shutdown | INTERFACE PORT-CHANNEL |
| 5 | Repeat Steps 1 to 4 on the VLT peer switch to configure the VLT interconnect. | | |

Enable VLT and Create a VLT Domain

| Step | Task | Command Syntax | Command Mode |
|--|--|--|-----------------------------|
| 1 | Enable VLT on a switch, then configure a VLT domain and enter VLT-domain configuration mode. Range of domain IDs: 1 to 1000. You must configure the same domain ID on the peer switch to allow for common peering. VLT uses the domain ID to automatically create a VLT MAC address for the domain. If the system is not configured explicitly, the system mac-address of the primary will be the VLT MAC address for the domain. To disable VLT, enter the no vlt domain command. | vlt domain <i>domain-id</i> | CONFIGURATION |
| Note: Do not use MAC addresses such as “reserved” or “multicast.” | | | |
| 2 | Configure the IP address of the management interface on the remote VLT peer to be used as the endpoint of the VLT backup link for sending out-of-band hello messages. You can optionally specify the time interval used to send hello messages. Range: 1 to 5 seconds. | back-up destination <i>ip-address [interval seconds]</i> | VLT DOMAIN CONFIGURATION |

Enable VLT and Create a VLT Domain

| Step | Task | Command Syntax | Command Mode |
|------|---|--|-----------------------------|
| 3 | Configure the port channel to be used as the VLT interconnect between VLT peers in the domain. | peer-link port-channel <i>id-number</i> | VLT DOMAIN CONFIGURATION |
| 4 | (Optional) Prevent a possible loop during the bootup of a VLT peer switch or a device that accesses the VLT domain. LACP on VLT ports (on a VLT switch or access device), which are members of the virtual link trunk, is not brought up until the VLT domain is recognized on the access device. | lACP ungroup member-independent {vlt port-channel <i>port-channel-id</i> } | CONFIGURATION |
| 5 | Repeat Steps 1 to 4 on the VLT peer switch to configure the IP address of this switch as the endpoint of the VLT backup link and to configure the same port channel for the VLT interconnect. | | |

Configure a VLT backup link

| Step | Task | Command Syntax | Command Mode |
|------|---|---|-------------------------|
| 1 | Specify the management interface to be used for the backup link through an out-of-band management network. Enter the slot (0-1) and the port (0). | interface managementethernet <i>slot/</i> <i>port</i> | CONFIGURATION |
| 2 | Configure an IPv4 address (A.B.C.D) or IPv6 address (X:X:X:X::X) and mask (/x) on the interface. This is the IP address to be configured on the VLT peer with the back-up destination command. | {ip address <i>ipv4-address/</i> <i>mask</i> ipv6 address <i>ipv6-address/</i> <i>mask</i> } | MANAGEMENT INTERFACE |
| 3 | Ensure that the interface is active. | no shutdown | MANAGEMENT INTERFACE |
| 4 | Repeat Steps 1 to 3 on the VLT peer switch. | | |

Use the **delay-restore** command at any time to set an amount of time, in seconds, to delay the system from restoring the VLT port. Refer to [VLT Port Delayed Restoration](#) for more information. .

Configure a VLT port delay period

| Step | Task | Command Syntax | Command Mode |
|------|--|---|---------------|
| 1 | Enter VLT-domain configuration mode for a specified VLT domain. Range of domain IDs: 1 to 1000. | vlt domain <i>domain-id</i> | CONFIGURATION |
| 2 | Enter an amount of time, in seconds, to delay the restoration of the VLT ports after the system is rebooted. Range: 1-1200 Default: 90 seconds | delay-restore <i>delay-restore-time</i> | CONFIGURATION |

(Optional) Reconfigure default VLT settings

| Step | Task | Command Syntax | Command Mode |
|-------------|---|--|-----------------------------|
| 1 | Enter VLT-domain configuration mode for a specified VLT domain. Range of domain IDs: 1 to 1000. | vlt domain <i>domain-id</i> | CONFIGURATION |
| 2 | (Optional) After you configure the VLT domain on each peer switch on both sides of the interconnect trunk, by default, the FTOS software elects a primary and secondary VLT peer device. Use the primary-priority command to reconfigure the primary role of VLT peer switches. To configure the primary role on a VLT peer, enter a lower <i>value</i> than the priority value of the remote peer. Priority values are from 1 to 65535. Default: 32768. | primary-priority <i>value</i> | VLT DOMAIN CONFIGURATION |
| 3 | (Optional) When you create a VLT domain on a switch, the FTOS software automatically creates a VLT-system MAC address used for internal system operations. Use the system-mac command to explicitly configure the default MAC address for the domain by entering a new MAC address in the format: <i>aaaa.bbbb.cccc</i> . You must also reconfigure the same MAC address on the VLT peer switch. Use this command to minimize the time required for the VLT system to synchronize the default MAC address of the VLT domain on both peer switches when one peer switch reboots. | system-mac <i>mac-address</i> <i>mac-address</i> | VLT DOMAIN CONFIGURATION |
| 4 | (Optional) When you create a VLT domain on a switch, the FTOS software automatically assigns a unique unit ID (0 or 1) to each peer switch. The unit IDs are used for internal system operations. Use the unit-id command to explicitly configure the default values on each peer switch. You must configure a different unit ID (0 or 1) on each peer switch. Use this command to minimize the time required for the VLT system to determine the unit ID assigned to each peer switch when one peer switch reboots. | unit-id {0 1} | VLT DOMAIN CONFIGURATION |

Connect a VLT domain to an attached access device (switch or server)

| Step | Task | Command Syntax | Command Mode |
|------|--|--|---------------------------|
| | On a VLT peer switch: Configure the same port channel ID number on each peer switch in the VLT domain to connect to an attached device as follows: | | |
| 1 | Configure the same port channel to be used to connect to an attached device and enter interface configuration mode. | interface port-channel <i>id-number</i> | CONFIGURATION |
| 2 | Remove an IP address from the interface. | no ip address | INTERFACE PORT-CHANNEL |
| 3 | Place the interface in Layer 2 mode. | switchport | INTERFACE PORT-CHANNEL |
| 4 | Add one or more port interfaces to the port channel. <i>interface</i> specifies one of the following interface types: 1-Gigabit Ethernet: Enter gigabitethernet <i>slot/port</i> . 10-Gigabit Ethernet: Enter tengigabitethernet <i>slot/port</i> . | channel-member <i>interface</i> | INTERFACE PORT-CHANNEL |
| 5 | Ensure that the port channel is active. | no shutdown | INTERFACE PORT-CHANNEL |
| 6 | Associate the port channel to the corresponding port channel in the VLT peer for the VLT connection to an attached device. Valid port-channel ID numbers are from 1 to 128. | vlt-peer-lag port-channel <i>id-number</i> | INTERFACE PORT-CHANNEL |
| 7 | Repeat Steps 1 to 6 on the VLT peer switch to configure the same port channel as part of the VLT domain. | | |
| 8 | On an attached switch or server: Configure a port channel to connect to the VLT domain and add port channels to it. Figure 53-13 shows how to verify the port-channel configuration. | | |

Use the **peer-down-vlan** parameter to configure the VLAN where a VLT peer will forward received packets over the VLTi from an adjacent VLT peer that is down. When a VLT peer with BMP reboots, untagged DHCP discover packets are sent to the peer over the VLTi. Using this configuration ensures the DHCP discover packets are forwarded to the VLAN that has the DHCP server. .

(Optional) Configure a VLT VLAN peer-down

| Step | Task | Command Syntax | Command Mode |
|------|--|---|-----------------------------|
| 1 | Enter VLT-domain configuration mode for a specified VLT domain. Range of domain IDs: 1 to 1000. | vlt domain <i>domain-id</i> | CONFIGURATION |
| 2 | Enter the port-channel number that will act as the interconnect trunk. Range: 1 to 128. | peer-link port-channel <i>id-number</i> | VLT DOMAIN CONFIGURATION |

(Optional) Configure a VLT VLAN peer-down

| Step | Task | Command Syntax | Command Mode |
|------|---|--|--------------------------|
| 3 | Enter the VLAN ID number of the VLAN where the VLT forwards packets received on the VLTi from an adjacent peer that is down. Range: 1 to 4094. | peer-down-vlan <i>vlan interface number</i> | VLT DOMAIN CONFIGURATION |

Use the following procedure to configure enhanced VLT between two VLT domains on your network. Refer to [eVLT Configuration Example](#) for a sample configuration.

(Optional) Configure Enhanced VLT (eVLT)

| Step | Task | Command Syntax | Command Mode |
|------------------------------|---|---|--------------------------|
| Set up the VLT domain | | | |
| 1 | Configure the port channel to be used for the VLT interconnect on a VLT switch and enter interface configuration mode. Enter the same port-channel number configured with the peer-link port-channel command in the Enable VLT and Create a VLT Domain steps. | interface port-channel <i>id-number</i> | CONFIGURATION |
| 2 | Add one or more port interfaces to the port channel. <i>interface</i> specifies one of the following interface types: 1-Gigabit Ethernet: Enter gigabitethernet slot/port . 10-Gigabit Ethernet: Enter tengigabitethernet slot/port . | channel-member <i>interface</i> | INTERFACE PORT-CHANNEL |
| 3 | Enter VLT-domain configuration mode for a specified VLT domain. Range of domain IDs: 1 to 1000. | vlt domain <i>domain-id</i> | CONFIGURATION |
| 4 | Enter the port-channel number that will act as the interconnect trunk. Range: 1 to 128. | peer-link port-channel <i>id-number</i> | VLT DOMAIN CONFIGURATION |
| 5 | Configure the IP address of the management interface on the remote VLT peer to be used as the endpoint of the VLT backup link for sending out-of-band hello messages. You can optionally specify the time interval used to send hello messages. Range: 1 to 5 seconds. | back-up destination <i>ip-address [interval seconds]</i> | VLT DOMAIN CONFIGURATION |

(Optional) Configure Enhanced VLT (eVLT)

| Step | Task | Command Syntax | Command Mode |
|------|--|--|-----------------------------|
| 6 | <p>When you create a VLT domain on a switch, the FTOS software automatically creates a VLT-system MAC address used for internal system operations.</p> <p>Use the system-mac command to explicitly configure the default MAC address for the domain by entering a new MAC address in the format: <code>aaaa.bbbb.cccc</code>.</p> <p>You must also reconfigure the same MAC address on the VLT peer switch.</p> <p>Use this command to minimize the time required for the VLT system to synchronize the default MAC address of the VLT domain on both peer switches when one peer switch reboots.</p> | system-mac <i>mac-address</i> <i>mac-address</i> | VLT DOMAIN CONFIGURATION |
| 7 | <p>When you create a VLT domain on a switch, the FTOS software automatically assigns a unique unit ID (0 or 1) to each peer switch. The unit IDs are used for internal system operations.</p> <p>Use the unit-id command to explicitly configure the default values on each peer switch.</p> <p>You must configure a different unit ID (0 or 1) on each peer switch.</p> <p>Use this command to minimize the time required for the VLT system to determine the unit ID assigned to each peer switch when one peer switch reboots.</p> | unit-id {0 1} | VLT DOMAIN CONFIGURATION |
| 8 | Configure enhanced VLT. | | |
| 9 | <p>Configure the port channel to be used for the VLT interconnect on a VLT switch and enter interface configuration mode.</p> <p>Enter the same port-channel number configured with the peer-link port-channel command in the Enable VLT and Create a VLT Domain steps.</p> | interface port-channel <i>id-number</i> | CONFIGURATION |
| 10 | Place the interface in Layer 2 mode. | switchport | INTERFACE PORT-CHANNEL |
| 11 | <p>Associate the port channel to the corresponding port channel in the VLT peer for the VLT connection to an attached device.</p> <p>Valid port-channel ID numbers are from 1 to 128.</p> | vlt-peer-lag port-channel <i>id-number</i> | INTERFACE PORT-CHANNEL |
| 12 | Ensure that the port channel is active. | no shutdown | INTERFACE PORT-CHANNEL |
| 13 | Add links to the eVLT port. | | |
| 14 | Configure a range of interfaces to bulk configure. | interface range { <i>port-channel id</i> } | CONFIGURATION |

(Optional) Configure Enhanced VLT (eVLT)

| Step | Task | Command Syntax | Command Mode |
|------|---|---|-------------------------|
| 15 | Enable LACP on the LAN port. | port-channel-protocol lacp | INTERFACE |
| 16 | Configure the LACP port channel mode. | port-channel <i>number</i> mode [active] | INTERFACE |
| 17 | Ensure that the interface is active. | no shutdown | MANAGEMENT INTERFACE |
| 18 | Repeat steps 1 through 15 for the VLT peer node in Domain 1. | | |
| 19 | Repeat steps 1 through 15 for the first VLT node in Domain 2. | | |
| 20 | Repeat steps 1 through 15 for the VLT peer node in Domain 2. | | |

To verify the configuration of a VLT domain, enter any of the **show** commands described in [Verifying a VLT Configuration](#).

For a sample configuration, see the following steps.

| Task | Command Syntax | Command Mode |
|--|--|------------------------|
| Configure the VLT domain with the same ID in VLT peer 1 and VLT peer 2 | vlt domain <i>domain id</i> | VLT DOMAIN |
| Configure the VLTi between VLT peer 1 and VLT peer 2. | | |
| 1. LACP/Static LAG can be configured between the peer units (not shown). | interface port-channel <i>port-channel id</i> | CONFIGURATION |
| Note: To benefit from the protocol negotiations, Dell Force10 recommends VLTs used as facing hosts/switches are configured with LACP. Both peers should use the same port channel ID. | | |
| 2. Configure the peer-link port-channel in the VLT domains of each peer unit. | channel-member | INTERFACE PORTCHANNEL |
| Configure the backup link between the VLT peer units. | | |
| 1. Configure the peer 2 management ip/ interface ip for which connectivity is present in VLT peer 1. | show running-config vlt | EXEC Privilege |
| 2. Configure the peer 1 management ip/ interface ip for which connectivity is present in VLT peer 1. | show interfaces <i>interface</i> | EXEC EXEC Privilege |

Configure the VLT links between VLT peer 1 and VLT peer 2 to the top of rack unit.

| Task | Command Syntax | Command Mode |
|--|--|------------------------|
| 1. Configure the static LAG/LACP between ports connected from VLT peer 1 and VLT peer 2 to the top of rack unit. | show running-config <i>entity</i> | EXEC Privilege |
| 2. Configure the VLT peer link port channel id in VLT peer 1 and VLT peer 2. | show interfaces <i>interface</i> | EXEC EXEC Privilege |
| 3. In the top of rack unit, configure LACP in the physical ports | show running-config <i>entity</i> | EXEC Privilege |
| Verify VLT is running. | show vlt brief | EXEC |
| | show vlt detail | EXEC |
| Verify the VLT LAG is running in both VLT peer units. | show interfaces <i>interface</i> | EXEC EXEC Privilege |

In the following sample VLT configuration steps, VLT peer 1 is S4810-2, VLT peer 2 is S4810-4, and the ToR is S60-1:



Note: If a third-party ToR unit is used, Dell Force10 recommends using static LAGs with VLT peers to avoid potential problems if the VLT peers are rebooted.



Note: The examples use S4810 systems, but the example can apply to the S4820T platform as well.

Configure the VLT domain with the same ID in VLT peer 1 and VLT peer 2

```
s4810-2(conf)#vlt domain 5
s4810-2(conf-vlt-domain)#
```

```
s4810-4(conf)#vlt domain 5
s4810-4(conf-vlt-domain)#
```

Configure the VLTi between VLT peer 1 and VLT peer 2:

1. LACP/Static LAG can be configured between the peer units (not shown)
2. Configure the peer-link port-channel in the VLT domains of each peer unit.

```
s4810-2(conf)#interface port-channel 1
s4810-2(conf-if-po-1)#channel-member TenGigabitEthernet 0/4-7
s4810-4(conf)#interface port-channel 1
s4810-4(conf-if-po-1)#channel-member TenGigabitEthernet 0/4-7
```

Configure the backup link between the VLT peer units.

1. Configure the peer 2 management ip/ interface ip for which connectivity is present in VLT peer 1.
2. Configure the peer 1 management ip/ interface ip for which connectivity is present in VLT peer 2.

```

s4810-2#show running-config vlt
!
vlt domain 5
  peer-link port-channel 1
  back-up destination 10.11.206.58
s4810-2#

s4810-2# show interfaces managementethernet 0/0
Internet address is 10.11.206.43/16

s4810-4#show running-config vlt
!
vlt domain 5
  peer-link port-channel 1
  back-up destination 10.11.206.43
s4810-4#
s4810-4#show running-config interface managementethernet 0/0
ip address 10.11.206.58/16
no shutdown

```

Configure the VLT links between VLT peer 1 and VLT peer 2 to the top of rack unit. In the following example, port Te 0/40 in VLT peer 1 is connected to Te 0/48 of TOR and port Te 0/18 in VLT peer 2 is connected to Te 0/50 of TOR.

1. Configure the static LAG/LACP between ports connected from VLT peer 1 and VLT peer 2 to the top of rack unit.
2. Configure the VLT peer link port channel id in VLT peer 1 and VLT peer 2.
3. In the top of rack unit, configure LACP in the physical ports (shown for VLT peer 1 only. Repeat steps for VLT peer 2. The highlighted **vlt-peer-lag port-channel 2** indicates that port-channel 2 is the port-channel id configured in VLT peer 2).

```

s4810-2#show running-config interface tengigabitethernet 0/40
!
interface TenGigabitEthernet 0/40
  no ip address
!
  port-channel-protocol LACP
  port-channel 2 mode active
  no shutdown
s4810-2#
configuring VLT peer lag in VLT
s4810-2#show running-config interface port-channel 2
!
interface Port-channel 2
  no ip address
  switchport
  vlt-peer-lag port-channel 2
  no shutdown
s4810-2#
s4810-2#show interfaces port-channel 2 brief
Codes: L - LACP Port-channel

      LAG  Mode  Status      Uptime      Ports
L  2     L2L3  up          03:33:14    Te 0/40    (Up)
s4810-2#

```

In the ToR unit, configure LACP on the physical ports.

```

s60-1#show running-config interface tengigabitethernet 0/48
!
interface TenGigabitEthernet 0/48
  no ip address

```

```

!
port-channel-protocol LACP
port-channel 100 mode active
no shutdown
s60-1#show running-config interface tengigabitethernet 0/50
!
interface TenGigabitEthernet 0/50
no ip address
!
port-channel-protocol LACP
port-channel 100 mode active
no shutdown
s60-1#

s60-1#show running-config interface port-channel 100
!
interface Port-channel 100
no ip address
switchport
no shutdown
s60-1#
s60-1#show interfaces port-channel 100 brief
Codes: L - LACP Port-channel

      LAG Mode  Status      Uptime      Ports
L  100 L2     up           03:33:48    Te 0/48    (Up)
                                Te 0/50    (Up)

s60-1#

```

Verify VLT is up. Verify that the VLTi (ICL) link, backup link connectivity (heartbeat status) and VLT peer link (peer chassis) are all up:

```

s4810-2#show vlt brief
VLT Domain Brief
-----
Domain ID:                5
Role:                     Primary
Role Priority:            32768
ICL Link Status:         Up
HeartBeat Status:       Up
VLT Peer Status:        Up
Local System MAC address: 00:01:e8:8c:4d:08
Remote System MAC address: 00:01:e8:8c:4d:1c
s4810-2#

s4810-2#show vlt detail
Local LAG Id  Peer LAG Id  Local Status  Active VLANs
-----
2             2            Up            1000-1199

```

Verify the VLT LAG is up in both VLT peer units.

```

s4810-2#show interfaces port-channel 2 brief
Codes: L - LACP Port-channel

      LAG Mode  Status      Uptime      Ports
L  2    L2L3  up           03:43:24    Te 0/40    (Up)
s4810-2#
s4810-4#show interfaces port-channel 2 brief
Codes: L - LACP Port-channel

      LAG Mode  Status      Uptime      Ports
L  2    L2L3  up           03:33:31    Te 0/18    (Up)

```

eVLT Configuration Example

The following example demonstrates the steps to configure enhanced VLT (eVLT) in a network. In this example there are two domains being configured. Domain 1 consists of Peer 1 and Peer 2; Domain 2 consists of Peer 3 and Peer 4 as shown below.

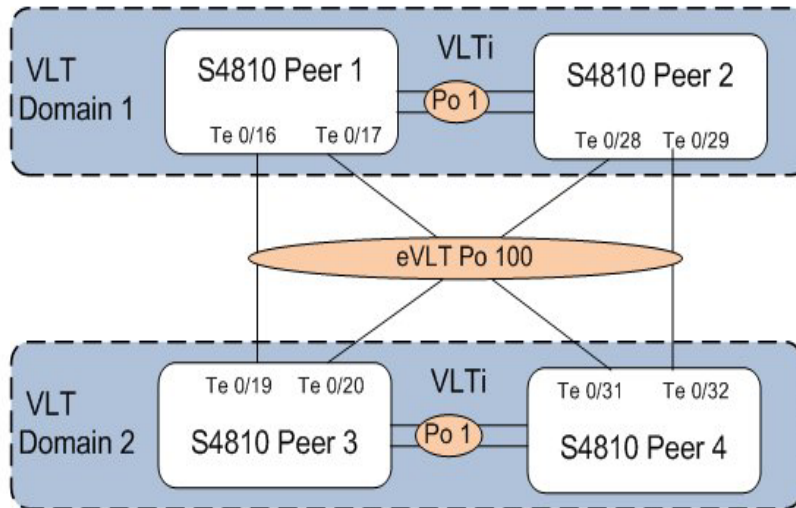

In Domain 1, configure Peer 1 first, then configure Peer 2. When that is complete, perform the same steps for the peer nodes in Domain 2. The interface used in this example is TenGigabitEthernet.

In Domain 1, configure the VLT domain and VLTi on Peer 1:

```
Domain_1_Peer1#configure
Domain_1_Peer1(conf)#interface port-channel 1
Domain_1_Peer1(conf-if-po-1)# channel-member TenGigabitEthernet 0/8-9

Domain_1_Peer1(conf)#vlt domain 1000
Domain_1_Peer1(conf-vlt-domain)# peer-link port-channel 1
Domain_1_Peer1(conf-vlt-domain)# back-up destination 10.16.130.11
Domain_1_Peer1(conf-vlt-domain)# system-mac mac-address 00:0a:00:0a:00:0a
Domain_1_Peer1(conf-vlt-domain)# unit-id 0
```

Configure eVLT on Peer 1:

```
Domain_1_Peer1(conf)#interface port-channel 100
Domain_1_Peer1(conf-if-po-100)# switchport
Domain_1_Peer1(conf-if-po-100)# vlt-peer-lag port-channel 100
Domain_1_Peer1(conf-if-po-100)# no shutdown
```

Add links to the eVLT port-channel on Peer 1:

```
Domain_1_Peer1(conf)#interface range tengigabitethernet 0/16 - 17
```

```
Domain_1_Peer1(conf-if-range-te-0/16-17)# port-channel-protocol LACP
Domain_1_Peer1(conf-if-range-te-0/16-17)# port-channel 100 mode active
Domain_1_Peer1(conf-if-range-te-0/16-17)# no shutdown
```

Next, configure the VLT domain and VLTi on Peer 2:

```
Domain_1_Peer2#configure
Domain_1_Peer2(conf)#interface port-channel 1
Domain_1_Peer2(conf-if-po-1)# channel-member TenGigabitEthernet 0/8-9

Domain_1_Peer2(conf)#vlt domain 1000
Domain_1_Peer2(conf-vlt-domain)# peer-link port-channel 1
Domain_1_Peer2(conf-vlt-domain)# back-up destination 10.16.130.12
Domain_1_Peer2(conf-vlt-domain)# system-mac mac-address 00:0a:00:0a:00:0a
Domain_1_Peer2(conf-vlt-domain)# unit-id 1
```

Configure eVLT on Peer 2:

```
Domain_1_Peer2(conf)#interface port-channel 100
Domain_1_Peer2(conf-if-po-100)# switchport
Domain_1_Peer2(conf-if-po-100)# vlt-peer-lag port-channel 100
Domain_1_Peer2(conf-if-po-100)# no shutdown
```

Add links to the eVLT port-channel on Peer 2:

```
Domain_1_Peer2(conf)#interface range tengigabitethernet 0/28 - 29
Domain_1_Peer2(conf-if-range-te-0/16-17)# port-channel-protocol LACP
Domain_1_Peer2(conf-if-range-te-0/16-17)# port-channel 100 mode active
Domain_1_Peer2(conf-if-range-te-0/16-17)# no shutdown
```

In Domain 2, configure the VLT domain and VLTi on Peer 3:

```
Domain_2_Peer3#configure
Domain_2_Peer3(conf)#interface port-channel 1
Domain_2_Peer3(conf-if-po-1)# channel-member TenGigabitEthernet 0/8-9

Domain_2_Peer3(conf)#vlt domain 1000
Domain_2_Peer3(conf-vlt-domain)# peer-link port-channel 1
Domain_2_Peer3(conf-vlt-domain)# back-up destination 10.18.130.11
Domain_2_Peer3(conf-vlt-domain)# system-mac mac-address 00:0b:00:0b:00:0b
Domain_2_Peer3(conf-vlt-domain)# unit-id 0
```

Configure eVLT on Peer 3:

```
Domain_2_Peer3(conf)#interface port-channel 100
Domain_2_Peer3(conf-if-po-100)# switchport
Domain_2_Peer3(conf-if-po-100)# vlt-peer-lag port-channel 100
Domain_2_Peer3(conf-if-po-100)# no shutdown
```

Add links to the eVLT port-channel on Peer 3:

```

Domain_2_Peer3(conf)#interface range tengigabitethernet 0/19 - 20
Domain_2_Peer3(conf-if-range-te-0/16-17)# port-channel-protocol LACP
Domain_2_Peer3(conf-if-range-te-0/16-17)# port-channel 100 mode active
Domain_2_Peer3(conf-if-range-te-0/16-17)# no shutdown

```

Next, configure the VLT domain and VLTi on Peer 4:

```

Domain_2_Peer4#configure
Domain_2_Peer4(conf)#interface port-channel 1
Domain_2_Peer4(conf-if-po-1)# channel-member TenGigabitEthernet 0/8-9

Domain_2_Peer4(conf)#vlt domain 1000
Domain_2_Peer4(conf-vlt-domain)# peer-link port-channel 1
Domain_2_Peer4(conf-vlt-domain)# back-up destination 10.18.130.12
Domain_2_Peer4(conf-vlt-domain)# system-mac mac-address 00:0b:00:0b:00:0b
Domain_2_Peer4(conf-vlt-domain)# unit-id 1

```

Configure eVLT on Peer 4:

```

Domain_2_Peer4(conf)#interface port-channel 100
Domain_2_Peer4(conf-if-po-100)# switchport
Domain_2_Peer4(conf-if-po-100)# vlt-peer-lag port-channel 100
Domain_2_Peer4(conf-if-po-100)# no shutdown

```

Add links to the eVLT port-channel on Peer 4:

```

Domain_2_Peer4(conf)#interface range tengigabitethernet 0/31 - 32
Domain_2_Peer4(conf-if-range-te-0/16-17)# port-channel-protocol LACP
Domain_2_Peer4(conf-if-range-te-0/16-17)# port-channel 100 mode active
Domain_2_Peer4(conf-if-range-te-0/16-17)# no shutdown

```

PIM-Sparse Mode Configuration Example

The sample configuration below shows how to configure the PIM Sparse mode designated router functionality on the VLT domain with two VLT port-channels that are members of VLAN 4001. Refer to the figure in [PIM-Sparse Mode Support on VLT](#).

Enable PIM Multicast Routing on the VLT node globally

```

VLT_Peer1(conf)#ip multicast-routing

```

Enable PIM on the VLT port VLANs

```

VLT_Peer1(conf)#interface vlan 4001
VLT_Peer1(conf-if-vl-4001)#ip address 140.0.0.1/24
VLT_Peer1(conf-if-vl-4001)#ip pim sparse-mode
VLT_Peer1(conf-if-vl-4001)#tagged port-channel 101
VLT_Peer1(conf-if-vl-4001)#tagged port-channel 102
VLT_Peer1(conf-if-vl-4001)#no shutdown
VLT_Peer1(conf-if-vl-4001)#exit

```

Configure the VLTi port as a Static Multicast Router port for the VLAN

```
VLT_Peer1(conf)#interface vlan 4001
VLT_Peer1(conf-if-vl-4001)#ip igmp snooping mrouter interface port-channel 128
VLT_Peer1(conf-if-vl-4001)#exit
VLT_Peer1(conf)#end
```

Repeat these steps on VLT Peer Node 2

```
VLT_Peer2(conf)#ip multicast-routing

VLT_Peer2(conf)#interface vlan 4001
VLT_Peer2(conf-if-vl-4001)#ip address 140.0.0.2/24
VLT_Peer2(conf-if-vl-4001)#ip pim sparse-mode
VLT_Peer2(conf-if-vl-4001)#tagged port-channel 101
VLT_Peer2(conf-if-vl-4001)#tagged port-channel 102
VLT_Peer2(conf-if-vl-4001)#no shutdown

VLT_Peer2(conf-if-vl-4001)#ip igmp snooping mrouter interface port-channel 128
VLT_Peer2(conf-if-vl-4001)#exit
VLT_Peer2(conf)#end
```

Verifying a VLT Configuration

To monitor the operation or verify the configuration of a VLT domain, enter any of the following **show** commands in EXEC mode on the primary and secondary VLT switches:

| Show Command Syntax | Description |
|--------------------------------|---|
| show vlt backup-link | Displays information on backup link operation (see Figure 53-4). |
| show vlt brief | Displays general status information about VLT domains currently configured on the switch (see Figure 53-5). |
| show vlt detail | Displays detailed information about the VLT-domain configuration, including local and peer port-channel IDs, local VLT switch status, and number of active VLANs on each port channel (see Figure 53-6). |
| show vlt role | Displays the VLT peer status, role of the local VLT switch, VLT system MAC address and system priority, and the MAC address and priority of the locally-attached VLT device (see Figure 53-7). |
| show running-config vlt | Displays the current configuration of all VLT domains (Figure 53-8) or a specified group on the switch. |
| show vlt statistics | Displays statistics on VLT operation (see Figure 53-9). |
| show spanning-tree rstp | Displays the RSTP configuration on a VLT peer switch, including the status of port channels used in the VLT interconnect trunk and to connect to access devices (see Figure 53-10). |

| Show Command Syntax | Description |
|---|--|
| show interfaces <i>interface</i> | <p>Displays the current status of a port or port-channel interface used in the VLT domain.</p> <p><i>interface</i> specifies one of the following interface types:</p> <p>Fast Ethernet: Enter fastethernet <i>slot/port</i>.</p> <p>1-Gigabit Ethernet: Enter gigabitethernet <i>slot/port</i>.</p> <p>10-Gigabit Ethernet: Enter tengigabitethernet <i>slot/port</i>.</p> <p>Port channel: Enter port-channel {1-128}.</p> |

Figure 53-4. show vlt backup-link Command Output on VLT peer switches

```

FTOS_VLTpeer1# show vlt backup-link

VLT Backup Link
-----
Destination:                10.11.200.18
Peer HeartBeat status:      Up
HeartBeat Timer Interval:   1
HeartBeat Timeout:         3
UDP Port:                   34998
HeartBeat Messages Sent:    1026
HeartBeat Messages Received: 1025

FTOS_VLTpeer2# show vlt backup-link

VLT Backup Link
-----
Destination:                10.11.200.20
Peer HeartBeat status:      Up
HeartBeat Timer Interval:   1
HeartBeat Timeout:         3
UDP Port:                   34998
HeartBeat Messages Sent:    1030
HeartBeat Messages Received: 1014

```

Figure 53-5. show vlt brief Command Output on VLT peer switches

```

FTOS_VLTpeer1# show vlt brief
VLT Domain Brief
-----
Domain ID:                1000
Role:                     Secondary
Role Priority:            32768
ICL Link Status:         Up
HeartBeat Status:        Up
VLT Peer Status:         Up
Local Unit Id:           0
Version:                  5(1)
Local System MAC address: 00:01:e8:8a:e9:70
Remote System MAC address: 00:01:e8:8a:e7:e7
Configured System MAC address:00:0a:0a:01:01:0a
Remote system version:   5(1)
Delay-Restore timer:     90 seconds

```

```

FTOS_VLTpeer2# show vlt brief
VLT Domain Brief
-----
Domain ID:                1000
Role:                     Primary
Role Priority:            32768
ICL Link Status:         Up
HeartBeat Status:        Up
VLT Peer Status:         Up
Local Unit Id:           1
Version:                  5(1)
Local System MAC address: 00:01:e8:8a:e7:e7
Remote System MAC address: 00:01:e8:8a:e9:70
Configured System MAC address:00:0a:0a:01:01:0a
Remote system version:   5(1)
Delay-Restore timer:     90 seconds

```

Figure 53-6. show vlt detail Command Output

```

FTOS_VLTpeer1# show vlt detail

Local LAG Id  Peer LAG Id  Local Status  Peer Status  Active VLANs
-----
100           100           UP            UP            10, 20, 30
127           2             UP            UP            20, 30

FTOS_VLTpeer2# show vlt detail

Local LAG Id  Peer LAG Id  Local Status  Peer Status  Active VLANs
-----
2             127          UP            UP            20, 30
100           100          UP            UP            10, 20, 30

```

Figure 53-7. show vlt role Command Output on VLT peer switches

```
FTOS_VLTpeer1# show vlt role

VLT Role
-----
VLT Role:                Primary
System MAC address:      00:01:e8:8a:df:bc
System Role Priority:    32768
Local System MAC address: 00:01:e8:8a:df:bc
Local System Role Priority: 32768

FTOS_VLTpeer2# show vlt role

VLT Role
-----
VLT Role:                Secondary
System MAC address:      00:01:e8:8a:df:bc
System Role Priority:    32768
Local System MAC address: 00:01:e8:8a:df:e6
Local System Role Priority: 32768
```

Figure 53-8. show running-config vlt Command Output on VLT peer switches

```
FTOS_VLTpeer1# show running-config vlt
!
vlt domain 30
 peer-link port-channel 60
 back-up destination 10.11.200.18

FTOS_VLTpeer2# show running-config vlt
!
vlt domain 30
 peer-link port-channel 60
 back-up destination 10.11.200.20
```

Figure 53-9. show vlt statistics Command Output on VLT peer switches

```
FTOS_VLTpeer1# show vlt statistics

VLT Statistics
-----
HeartBeat Messages Sent:      987
HeartBeat Messages Received:  986
ICL Hello's Sent:             148
ICL Hello's Received:         98

FTOS_VLTpeer2# show vlt statistics

VLT Statistics
-----
HeartBeat Messages Sent:      994
HeartBeat Messages Received:  978
ICL Hello's Sent:             89
ICL Hello's Received:         89
```

Figure 53-10. show spanning-tree rstp Command Output on VLT peer switches

```
FTOS_VLTpeer1# show spanning-tree rstp brief
```

```
Executing IEEE compatible Spanning Tree Protocol
Root ID Priority 0, Address 0001.e88a.dff8
Root Bridge hello time 2, max age 20, forward delay 15
Bridge ID Priority 4096, Address 0001.e88a.d656
Configured hello time 2, max age 20, forward delay 15
```

| Interface Name | PortID | Prio | Cost | Sts | Cost | Designated Bridge ID | PortID |
|----------------|---------|------|--------|-----------|------|----------------------|---------|
| Po 1 | 128.2 | 128 | 200000 | DIS | 800 | 4096 0001.e88a.d656 | 128.2 |
| Po 3 | 128.4 | 128 | 200000 | DIS | 800 | 4096 0001.e88a.d656 | 128.4 |
| Po 4 | 128.5 | 128 | 200000 | DIS | 800 | 4096 0001.e88a.d656 | 128.5 |
| Po 100 | 128.101 | 128 | 800 | FWD(VLTi) | 800 | 0 0001.e88a.dff8 | 128.101 |
| Po 110 | 128.111 | 128 | 00 | FWD(vlt) | 800 | 4096 0001.e88a.d656 | 128.111 |
| Po 111 | 128.112 | 128 | 200000 | DIS(vlt) | 800 | 4096 0001.e88a.d656 | 128.112 |
| Po 120 | 128.121 | 128 | 2000 | FWD(vlt) | 800 | 4096 0001.e88a.d656 | 128.121 |

Displays the RSTP state of port channels in the VLT domain. Port channel 100 is used in the VLT interconnect trunk (VLTi) to connect to VLT peer2. Port channels 110, 111, and 120 are used to connect to access switches or servers (vlt).

```
FTOS_VLTpeer2# show spanning-tree rstp brief
```

```
Executing IEEE compatible Spanning Tree Protocol
Root ID Priority 0, Address 0001.e88a.dff8
Root Bridge hello time 2, max age 20, forward delay 15
Bridge ID Priority 0, Address 0001.e88a.dff8
We are the root
Configured hello time 2, max age 20, forward delay 15
```

| Interface Name | PortID | Prio | Cost | Sts | Cost | Designated Bridge ID | PortID |
|----------------|---------|------|--------|-----------|------|----------------------|---------|
| Po 1 | 128.2 | 128 | 200000 | DIS | 0 | 0 0001.e88a.dff8 | 128.2 |
| Po 3 | 128.4 | 128 | 200000 | DIS | 0 | 0 0001.e88a.dff8 | 128.4 |
| Po 4 | 128.5 | 128 | 200000 | DIS | 0 | 0 0001.e88a.dff8 | 128.5 |
| Po 100 | 128.101 | 128 | 800 | FWD(VLTi) | 0 | 0 0001.e88a.dff8 | 128.101 |
| Po 110 | 128.111 | 128 | 00 | FWD(vlt) | 0 | 0 0001.e88a.dff8 | 128.111 |
| Po 111 | 128.112 | 128 | 200000 | DIS(vlt) | 0 | 0 0001.e88a.dff8 | 128.112 |
| Po 120 | 128.121 | 128 | 2000 | FWD(vlt) | 0 | 0 0001.e88a.dff8 | 128.121 |

Sample Configuration: Virtual Link Trunking

To configure virtual link trunking, you must configure a backup link and interconnect trunk, create a VLT domain, configure a backup link and interconnect trunk, and connect the peer switches in a VLT domain to an attached access device (switch or server).

Figure 53-11 and Figure 53-12 show a sample configuration of virtual link trunking on each VLT peer switch.

Figure 53-13 shows how to verify the connection to a VLT domain from an attached switch.

Figure 53-11. Configuring Virtual Link Trunking (VLT Peer 1)

```

FTOS_VLTpeer1(conf)#vlt domain 999
FTOS_VLTpeer1(conf-vlt-domain)#peer-link port-channel 100
FTOS_VLTpeer1(conf-vlt-domain)#back-up destination 10.11.206.35
FTOS_VLTpeer1(conf-vlt-domain)#exit

```

Enable VLT and create a VLT domain with a backup-link and interconnect trunk

```

FTOS_VLTpeer1(conf)#interface ManagementEthernet 0/0
FTOS_VLTpeer1(conf-if-ma-0/0)#ip address 10.11.206.23/
FTOS_VLTpeer1(conf-if-ma-0/0)#no shutdown
FTOS_VLTpeer1(conf-if-ma-0/0)#exit

```

Configure the backup link

```

FTOS_VLTpeer1(conf)#interface port-channel 100
FTOS_VLTpeer1(conf-if-po-100)#no ip address
FTOS_VLTpeer1(conf-if-po-100)#channel-member fortyGigE 0/56,60
FTOS_VLTpeer1(conf-if-po-100)#no shutdown
FTOS_VLTpeer1(conf-if-po-100)#exit

```

Configure the VLT interconnect

```

FTOS_VLTpeer1(conf)#interface port-channel 110
FTOS_VLTpeer1(conf-if-po-110)#no ip address
FTOS_VLTpeer1(conf-if-po-110)#switchport
FTOS_VLTpeer1(conf-if-po-110)#channel-member fortyGigE 0/52
FTOS_VLTpeer1(conf-if-po-110)#no shutdown
FTOS_VLTpeer1(conf-if-po-110)#vlt-peer-lag port-channel 110
FTOS_VLTpeer1(conf-if-po-110)#end

```

Configure the port channel to an attached device

```

FTOS_VLTpeer1# show vlan id 10
Codes: * - Default VLAN, G - GVRP VLANs, P - Primary, C - Community, I - Isolated
Q: U - Untagged, T - Tagged
  x - Dot1x untagged, X - Dot1x tagged
  G - GVRP tagged, M - Vlan-stack, H - Hyperpull tagged

```

Verify that the port channels used in the VLT domain are assigned to the same VLAN

| NUM | Status | Description | Q Ports |
|-----|--------|-------------|---|
| 10 | Active | | U Po110 (Fo 0/52) T Po100 (Fo 0/56,60) |

Figure 53-12. Configuring Virtual Link Trunking (VLT Peer 2)

```
FTOS_VLTpeer2(conf)#vlt domain 999
FTOS_VLTpeer2(conf-vlt-domain)#peer-link port-channel 100
FTOS_VLTpeer2(conf-vlt-domain)#back-up destination 10.11.206.23
FTOS_VLTpeer2(conf-vlt-domain)#exit
```

Enable VLT and create a VLT domain with a backup-link and interconnect trunk

```
FTOS_VLTpeer2(conf)#interface ManagementEthernet 0/0
FTOS_VLTpeer2(conf-if-ma-0/0)#ip address 10.11.206.35/
FTOS_VLTpeer2(conf-if-ma-0/0)#no shutdown
FTOS_VLTpeer2(conf-if-ma-0/0)#exit
```

Configure the backup link

```
FTOS_VLTpeer2(conf)#interface port-channel 100
FTOS_VLTpeer2(conf-if-po-100)#no ip address
FTOS_VLTpeer2(conf-if-po-100)#channel-member fortyGigE 0/46,50
FTOS_VLTpeer2(conf-if-po-100)#no shutdown
FTOS_VLTpeer2(conf-if-po-100)#exit
```

Configure the VLT interconnect

```
FTOS_VLTpeer2(conf)#interface port-channel 110
FTOS_VLTpeer2(conf-if-po-110)#no ip address
FTOS_VLTpeer2(conf-if-po-110)#switchport
FTOS_VLTpeer2(conf-if-po-110)#channel-member fortyGigE 0/48
FTOS_VLTpeer2(conf-if-po-110)#no shutdown
FTOS_VLTpeer2(conf-if-po-110)#vlt-peer-lag port-channel 110
FTOS_VLTpeer2(conf-if-po-110)#end
```

Configure the port channel to an attached device

```
FTOS_VLTpeer2# show vlan id 10
Codes: * - Default VLAN, G - GVRP VLANs, P - Primary, C - Community, I - Isolated
Q: U - Untagged, T - Tagged
   x - Dot1x untagged, X - Dot1x tagged
   G - GVRP tagged, M - Vlan-stack, H - Hyperpull tagged
```

Verify that the port channels used in the VLT domain are assigned to the same VLAN

| NUM | Status | Description | Q Ports |
|-----|--------|-------------|---|
| 10 | Active | | U Po110 (Fo 0/48) T Po100 (Fo 0/46,50) |

Figure 53-13. Verifying a Port-Channel Connection to a VLT Domain (From an Attached Access Switch)

```

FTOS_TORswitch(conf)# show running-config interface port-channel 11
!
interface Port-channel 11
 no ip address
 switchport
 channel-member fortyGigE 1/18,22
 no shutdown

```

On an access device, verify the port-channel connection to a VLT domain

Troubleshooting VLT

Use the following information to help to troubleshoot different VLT issues that may occur.



Note: For information on VLT failure mode timing and its impact, contact your Dell Force10 representative.

| Description | Behavior at Peer Up | Behavior During Run Time | Action to Take |
|---|--|--|--|
| Bandwidth monitoring | A syslog error message and an SNMP trap is generated when the VLTi bandwidth usage goes above the 80% threshold and when it drops below 80%. | A syslog error message and an SNMP trap is generated when the VLTi bandwidth usage goes above its threshold. | Depending on the traffic that is received, the traffic can be off loaded in VLTi. |
| Domain ID mismatch | The VLT peer does not boot up. The VLTi is forced to a down state. A syslog error message and an SNMP trap are generated. | The VLT peer does not boot up. The VLTi is forced to a down state. A syslog error message and an SNMP trap are generated. | Verify the domain ID matches on both VLT peers. |
| FTOS Version mismatch | A syslog error message is generated. | A syslog error message is generated. | Follow correct upgrade procedure for unit with mismatched FTOS version. |
| Remote VLT port channel status | N/A | N/A | Use the show vlt detail and show vlt brief commands to view VLT port channel status information. |
| Spanning tree mismatch at global level | All VLT port channels go down on both VLT peers. A syslog error message is generated. | No traffic is passed on the port channels. A one-time informational syslog message is generated. | During run time, a loop may occur as long as the mismatch lasts. To resolve, enable RSTP on both VLT peers. |

| Description | Behavior at Peer Up | Behavior During Run Time | Action to Take |
|---|--|--|--|
| Spanning tree mismatch at port level | A syslog error message is generated. | A one-time informational syslog message is generated. | Correct the spanning tree configuration on the ports. |
| System MAC mismatch | A syslog error message and an SNMP trap are generated. | A syslog error message and an SNMP trap are generated. | Verify that the unit ID of VLT peers is not the same on both units and that the MAC address is the same on both units. |
| Unit ID mismatch | The VLT peer does not boot up. The VLTi is forced to a down state. A syslog error message is generated. | The VLT peer does not boot up. The VLTi is forced to a down state. A syslog error message is generated. | Verify the unit ID is correct on both VLT peers. Unit ID numbers must be sequential on peer units; i.e., if Peer 1 is unit ID "0", Peer 2 unit ID must be "1". |
| Version ID mismatch | A syslog error message and an SNMP trap are generated. | A syslog error message and an SNMP trap are generated. | Verify the FTOS software versions on the VLT peers is compatible. For more information, see the <i>Release Notes</i> for this release. |
| VLT LAG ID is not configured on one VLT peer | A syslog error message is generated. The peer with the VLT configured remains active. | The peer with the VLT configured remains active. | Verify the VLT LAG ID is configured correctly on both VLT peers. |
| VLT LAG ID mismatch | The VLT port channel is brought down. A syslog error message is generated. | The VLT port channel is brought down. A syslog error message is generated. | Perform a mismatch check after the VLT peer is established. |

Reconfiguring Stacked Switches as VLT

To convert switches that have been stacked to VLT peers, use the following procedure.

1. Remove the current configuration from the switches. You will need to split the configuration up for each switch.
2. Copy the files to the flash memory of the appropriate switch.
3. Copy the files on the flash drive to the startup-config.
4. Reset the stacking ports to user ports for both switches.
5. Reload the stack and confirm the new configurations have been applied.
6. On the Secondary switch (stack-unit1), enter the command **stack-unit1 renumber 0**.
7. Confirm the reload query.

8. After reloading, confirm that VLT is enabled.
9. Confirm that the management ports are interconnected or connected to a switch that can transfer Heartbeat information.

Virtual Router Redundancy Protocol (VRRP)

Virtual Router Redundancy Protocol (VRRP) is supported on platforms: **e C S** **S4810**

S4820T

This chapter covers the following information:

- [VRRP Overview](#)
- [VRRP Benefits](#)
- [VRRP Implementation](#)
- [VRRP Configuration](#)
- [Sample Configurations](#)

VRRP Overview

Virtual Router Redundancy Protocol (VRRP) is designed to eliminate a single point of failure in a statically routed network.

VRRP specifies a MASTER router that owns the next hop IP and MAC address for end stations on a LAN. The MASTER router is chosen from the virtual routers by an election process and forwards packets sent to the next hop IP address. If the MASTER router fails, VRRP begins the election process to choose a new MASTER router and that new MASTER continues routing traffic.

VRRP uses the Virtual Router Identifier (VRID) to identify each virtual router configured. The IP address of the MASTER router is used as the next hop address for all end stations on the LAN. The other routers represented by IP addresses are BACKUP routers.

VRRP packets are transmitted with the virtual router MAC address as the source MAC address. The MAC address is in the following format: 00-00-5E-00-01-**{VRID}**. The first three octets are unchangeable. The next two octets (00-01) indicate the address block assigned to the VRRP protocol, and are unchangeable. The final octet changes depending on the VRRP Virtual Router Identifier and allows for up to 255 VRRP routers on a network.

Figure 54-1 shows a typical network configuration using VRRP. Instead of configuring the hosts on the network 10.10.10.0 with the IP address of either Router A or Router B as their default router; their default router is the IP Address configured on the virtual router. When any host on the LAN segment wants to access the Internet, it sends packets to the IP address of the virtual router.

In [Figure 54-1](#) below, Router A is configured as the MASTER router. It is configured with the IP address of the virtual router and sends any packets addressed to the virtual router through interface GigabitEthernet 1/1 to the Internet. As the BACKUP router, Router B is also configured with the IP address of the virtual router. If for any reason Router A becomes unavailable, VRRP elects a new MASTER Router. Router B assumes the duties of Router A and becomes the MASTER router. At that time, Router B responds to the packets sent to the virtual IP address.

All workstations continue to use the IP address of the virtual router to address packets destined to the Internet. Router B receives and forwards them on interface GigabitEthernet 10/1. Until Router A resumes operation, VRRP allows Router B to provide uninterrupted service to the users on the LAN segment accessing the Internet.

Figure 54-1. Basic VRRP Configuration

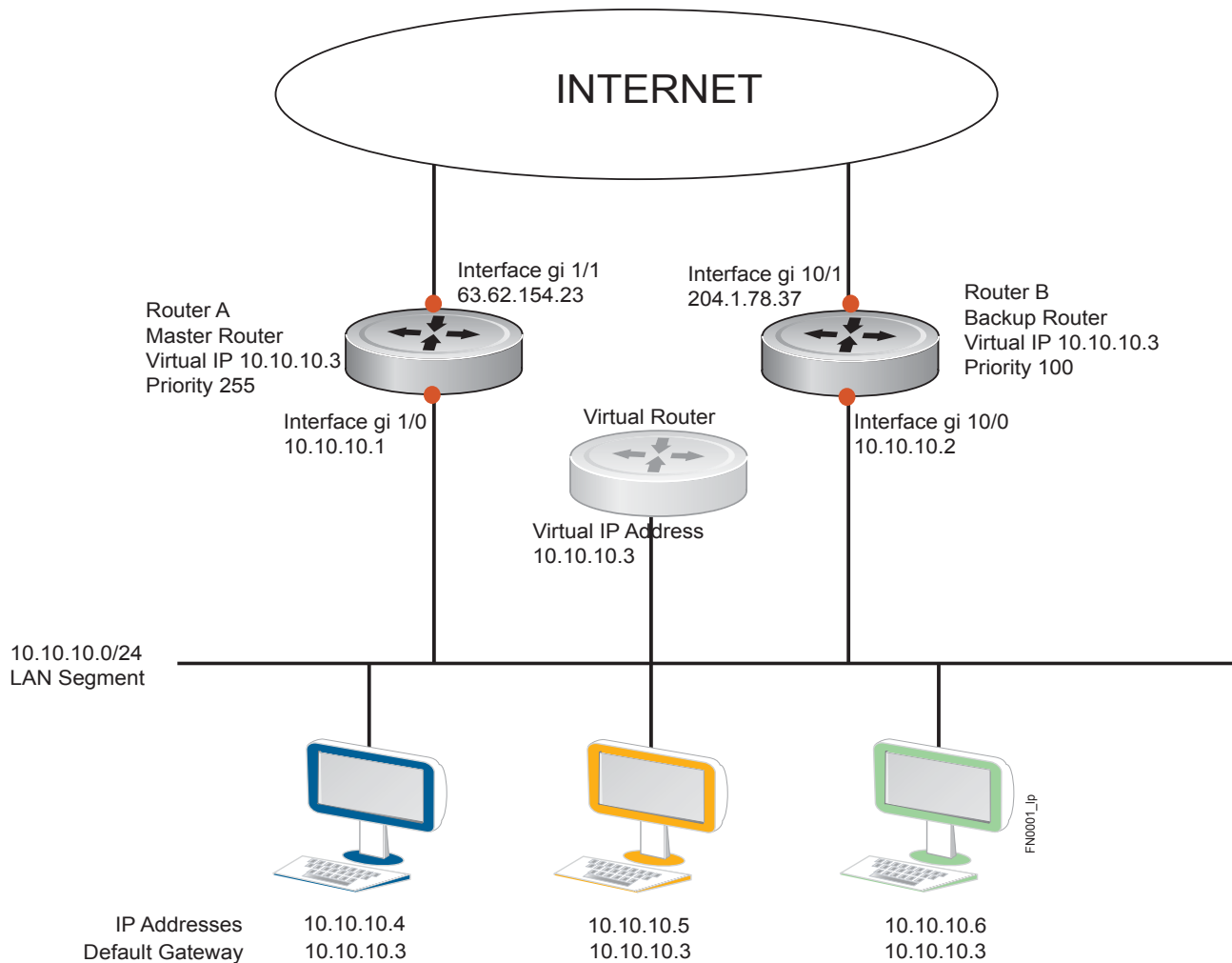

For more detailed information on VRRP, refer to [RFC 2338](#), *Virtual Router Redundancy Protocol*.

VRRP Benefits

With VRRP configured on a network, end-station connectivity to the network is not subject to a single point-of-failure. End-station connections to the network are redundant and they are not dependent on IGP protocols to converge or update routing tables.

VRRP Implementation

E-Series supports an unlimited total number of VRRP groups on the switch while supporting up to 255 VRRP groups on a single interface (Table 54-1).

C-Series supports a total of 128 VRRP groups on the switch with varying number of maximum VRRP groups per interface (Table 54-1).

S25/S50 supports a total of 120 VRRP groups on a switch with FTOS *or* a total of 20 VRRP groups when using SFTOS. The S-Series supports varying number of maximum VRRP groups per interface (Table 54-1).

The S4810 and S4820T support a total of 2000 VRRP groups on a switch and 512 VRRP groups per interface (Table 54-2).

The S55 and S60 support a total of 2000 VRRP groups on a switch and up to 100 VRRP groups per interface (Table 54-2).

Within a single VRRP group, up to 12 virtual IP addresses are supported. Virtual IP addresses can belong to the primary or secondary IP address' subnet configured on the interface. You can ping all the virtual IP addresses configured on the Master VRRP router from anywhere in the local subnet.

Though FTOS on E-Series supports unlimited VRRP groups, default VRRP settings may affect the maximum number of groups that can be configured and work efficiently, as a result of hardware throttling VRRP advertisement packets reaching the RP2 processor on the E-Series, the CP on the C-Series, S4810, S4820T, S55, and S60, or the FP on the S25/S50. To avoid throttling VRRP advertisement packets, Dell Force10 recommends you to increase the VRRP advertisement interval to a value higher than the default value of 1 second. The recommendations are as follows:

Table 54-1. Recommended VRRP Advertise Intervals

| Total VRRP Groups | Recommended Advertise Interval | | | Groups/Interface | | | |
|----------------------|--------------------------------|---------------|---------------------|-------------------|--------------------|----------|---------------------|
| | E-Series | C-Series | S-Series (S25, S50) | E-Series ExaScale | E-Series TeraScale | C-Series | S-Series (S25, S50) |
| Less than 250 | 1 second | 1 second | 1 second | 512 | 255 | 12 | 12 |
| Between 250 and 450 | 2 seconds | 2 - 3 seconds | 2 - 3 seconds | 512 | 255 | 24 | 24 |
| Between 450 and 600 | 3 seconds | 4 seconds | 3 - 4 seconds | 512 | 255 | 36 | 36 |
| Between 600 and 800 | 4 seconds | 5 seconds | 4 seconds | 512 | 255 | 48 | 48 |
| Between 800 and 1000 | 5 seconds | 5 seconds | 5 seconds | 512 | 255 | 84 | 84 |

Table 54-1. Recommended VRRP Advertise Intervals

| Total VRRP Groups | Recommended Advertise Interval | | | Groups/Interface | | | |
|-----------------------|--------------------------------|-----------|---------------------|-------------------|--------------------|----------|---------------------|
| | E-Series | C-Series | S-Series (S25, S50) | E-Series ExaScale | E-Series TeraScale | C-Series | S-Series (S25, S50) |
| Between 1000 and 1200 | 7 seconds | 7 seconds | 7 seconds | 512 | 255 | 100 | 100 |
| Between 1200 and 1500 | 8 seconds | 8 seconds | 8 seconds | 512 | 255 | 120 | 120 |

Table 54-2. Recommended VRRP Advertise Intervals on the S4810, S4820T, S55, S60

| Total VRRP Groups | Recommended Advertise Interval | | | Groups/Interface | | |
|-----------------------|--------------------------------|---------------|---------------|------------------|-----|-----|
| | S4810/S4820T | S55 | S60 | S4810/S4820T | S55 | S60 |
| Less than 250 | 1 second | 1 second | 1 second | 512 | 100 | 100 |
| Between 250 and 450 | 2 - 3 seconds | 2 - 3 seconds | 2 - 3 seconds | 512 | 100 | 100 |
| Between 450 and 600 | 3 - 4 seconds | 3 - 4 seconds | 3 - 4 seconds | 512 | 100 | 100 |
| Between 600 and 800 | 4 seconds | 4 seconds | 4 seconds | 512 | 100 | 100 |
| Between 800 and 1000 | 5 seconds | 5 seconds | 5 seconds | 512 | 100 | 100 |
| Between 1000 and 1200 | 7 seconds | 7 seconds | 7 seconds | 512 | 100 | 100 |
| Between 1200 and 1500 | 8 seconds | 8 seconds | 8 seconds | 512 | 100 | 100 |

The recommendations in [Table 54-1](#) may vary depending on various factors like ARP broadcasts, IP broadcasts, or STP before changing the advertisement interval. When the number of packets processed by RP2/CP/FP processor increases or decreases based on the dynamics of the network, the advertisement intervals in may increase or decrease accordingly.



CAUTION: Increasing the advertisement interval increases the VRRP Master dead interval, resulting in an increased failover time for Master/Backup election. Take extra caution when increasing the advertisement interval, as the increased dead interval may cause packets to be dropped during that switch-over time.

VRRP Configuration

By default, VRRP is not configured.

Configuration Task List for VRRP

The following list specifies the configuration tasks for VRRP:

- [Create a Virtual Router](#) (mandatory)
- [Assign Virtual IP addresses](#) (mandatory)
- [Set VRRP Group \(Virtual Router\) Priority](#) (optional)
- [Configure VRRP Authentication](#) (optional)

- Disable Preempt (optional)
- Change the Advertisement interval (optional)
- Track an Interface or Object (optional)
- VRRP initialization delay

For a complete listing of all commands related to VRRP, refer to *FTOS Command Line Interface*.

Create a Virtual Router

To enable VRRP, you must create a Virtual Router. In FTOS, a VRRP Group is identified by the Virtual Router Identifier (VRID).

To enable a Virtual Router, use the following command in the INTERFACE mode. To delete a VRRP group, use the **no vrrp-group vrid** command in the INTERFACE mode.

| Task | Command Syntax | Command Mode |
|--|---|--------------|
| Create a virtual router for that interface with a VRID. | vrrp-group vrid VRID Range: 1-255 | INTERFACE |
| Note: The interface must already have a Primary IP Address defined, and be enabled. | | |

Figure 54-2. Command Example: vrrp-group

```
FTOS(conf)#int gi 1/1
FTOS(conf-if-gi-1/1)#vrrp-group 111
FTOS(conf-if-gi-1/1-vrid-111)#
```

← Virtual Router ID and VRRP Group identifier

Figure 54-3. Command Example Display: show config for the Interface

```
FTOS(conf-if-gi-1/1)#show conf
!
interface GigabitEthernet 1/1
 ip address 10.10.10.1/24
!
 vrrp-group 111
 no shutdown
FTOS(conf-if-gi-1/1)#
```

Note that the interface has an IP Address and is enabled

Assign Virtual IP addresses

Virtual routers contain virtual IP addresses configured for that VRRP Group (VRID). A VRRP group does not transmit VRRP packets until you assign the Virtual IP address to the VRRP group.

E-Series supports an unlimited total number of VRRP Groups on the router while supporting up to 255 VRRP groups on a single interface (Table 54-1).

C-Series supports a total of 128 VRRP groups on the switch with varying number of maximum VRRP groups per interface (Table 54-1).

S-Series supports a total of 120 VRRP groups on a switch with FTOS *or* a total of 20 VRRP groups when using SFTOS. The S-Series supports varying number of maximum VRRP groups per interface (Table 54-1).

To activate a VRRP Group on an interface (so that VRRP group starts transmitting VRRP packets), configure at least one Virtual IP address in a VRRP group. The Virtual IP address is the IP address of the Virtual Router and does not require the IP address mask.

You can configure up to 12 Virtual IP addresses on a single VRRP Group (VRID).

The following rules apply to virtual IP addresses:

- The virtual IP addresses must be in the same subnet as the primary or secondary IP addresses configured on the interface. Though a single VRRP group can contain virtual IP addresses belonging to multiple IP subnets configured on the interface, Dell Force10 recommends you configure virtual IP addresses belonging to the *same* IP subnet for any one VRRP group.

For example, an interface (on which VRRP is to be enabled) contains a primary IP address of 50.1.1.1/24 and a secondary IP address of 60.1.1.1/24. The VRRP Group (VRID 1) must contain virtual addresses belonging to *either* subnet 50.1.1.0/24 or subnet 60.1.1.0/24, but not from both subnets (though FTOS allows the same).

- If the virtual IP address and the interface's primary/secondary IP address are the same, the priority on that VRRP group **MUST** be set to 255. The interface then becomes the OWNER router of the VRRP group and the interface's physical MAC address is changed to that of the owner VRRP group's MAC address.
- If multiple VRRP groups are configured on an interface, only one of the VRRP Groups can contain the interface primary or secondary IP address.

Configure a Virtual IP address with these commands in the following sequence in the INTERFACE mode.

| Step | Task | Command Syntax | Command Mode |
|------|---|---|-----------------|
| 1 | Configure a VRRP group. | vrrp-group <i>vrrp-id</i> VRID Range: 1-255 | INTERFACE |
| 2 | Configure virtual IP addresses for this VRID. | virtual-address <i>ip-address1</i> [... <i>ip-address12</i>] Range: up to 12 addresses | INTERFACE -VRID |

Figure 54-4. Command Example: virtual-address

```
FTOS (conf-if-gi-1/1-vrid-111) #virtual-address 10.10.10.1
FTOS (conf-if-gi-1/1-vrid-111) #virtual-address 10.10.10.2
FTOS (conf-if-gi-1/1-vrid-111) #virtual-address 10.10.10.3
FTOS (conf-if-gi-1/1-vrid-111) #
```

Figure 54-5. Command Example Display: show config for the Interface

Note that the Primary IP address and the Virtual IP addresses are on the same subnet in the following example.

```
FTOS(conf-if-gi-1/1)#show conf
!
interface GigabitEthernet 1/1
  ip address 10.10.10.1/24
!
vrrp-group 111
  priority 255
  virtual-address 10.10.10.1
  virtual-address 10.10.10.2
  virtual-address 10.10.10.3
!
vrrp-group 222
  no shutdown
FTOS(conf-if-gi-1/1)#
```

Figure 54-6 shows the same VRRP group (VRID 111) configured on multiple interfaces on different subnets.

Figure 54-6. Command Example Display: show vrrp

```
FTOSshow vrrp
-----
GigabitEthernet 1/1, VRID: 111, Net: 10.10.10.1
State: Master, Priority: 255, Master: 10.10.10.1 (local)
Hold Down: 0 sec, Preempt: TRUE, AdvInt: 1 sec
Adv rcvd: 0, Bad pkts rcvd: 0, Adv sent: 1768, Gratuitous ARP sent: 5
Virtual MAC address:
  00:00:5e:00:01:6f
Virtual IP address:
  10.10.10.1 10.10.10.2 10.10.10.3 10.10.10.10
Authentication: (none)
-----
GigabitEthernet 1/2, VRID: 111, Net: 10.10.2.1
State: Master, Priority: 100, Master: 10.10.2.1 (local)
Hold Down: 0 sec, Preempt: TRUE, AdvInt: 1 sec
Adv rcvd: 0, Bad pkts rcvd: 0, Adv sent: 27, Gratuitous ARP sent: 2
Virtual MAC address:
  00:00:5e:00:01:6f
Virtual IP address:
  10.10.2.2 10.10.2.3
Authentication: (none)
FTOS
```

When the VRRP process completes its initialization, the State field contains either Master or Backup.

Set VRRP Group (Virtual Router) Priority

Setting a Virtual Router priority to 255 ensures that router is the “owner” virtual router for the VRRP group. VRRP elects the MASTER router by choosing the router with the highest priority. The default priority for a Virtual Router is 100. The higher the number, the higher the priority. If the MASTER router fails, VRRP begins the election process to choose a new MASTER router based on the next-highest priority.

If two routers in a VRRP group come up at the same time and have the same priority value, the interface’s physical IP addresses are used as tie-breakers to decide which is MASTER. The router with the higher IP address will become MASTER.

Configure the VRRP Group’s priority with the following command in the VRRP mode:

| Task | Command Syntax | Command Mode |
|--|-----------------|--|
| Configure the priority for the VRRP group. | INTERFACE -VRID | priority <i>priority</i> Range: 1 to 255 Default: 100 |

Figure 54-7. Command Example: priority in Interface VRRP mode

```
FTOS(conf-if-gi-1/2)#vrrp-group 111
FTOS(conf-if-gi-1/2-vrid-111)#priority 125
```

Figure 54-8. Command Example Display: show vrrp

```
FTOSshow vrrp
-----
GigabitEthernet 1/1, VRID: 111, Net: 10.10.10.1
State: Master, Priority: 255, Master: 10.10.10.1 (local)
Hold Down: 0 sec, Preempt: TRUE, AdvInt: 1 sec
Adv rcvd: 0, Bad pkts rcvd: 0, Adv sent: 2343, Gratuitous ARP sent: 5
Virtual MAC address:
  00:00:5e:00:01:6f
Virtual IP address:
  10.10.10.1 10.10.10.2 10.10.10.3 10.10.10.10
Authentication: (none)
-----
GigabitEthernet 1/2, VRID: 111, Net: 10.10.2.1
State: Master, Priority: 125, Master: 10.10.2.1 (local)
Hold Down: 0 sec, Preempt: TRUE, AdvInt: 1 sec
Adv rcvd: 0, Bad pkts rcvd: 0, Adv sent: 601, Gratuitous ARP sent: 2
Virtual MAC address:
  00:00:5e:00:01:6f
Virtual IP address:
  10.10.2.2 10.10.2.3
Authentication: (none)
FTOS(conf)#
```

Configure VRRP Authentication

Simple authentication of VRRP packets ensures that only trusted routers participate in VRRP processes. When authentication is enabled, FTOS includes the password in its VRRP transmission, and the receiving router uses that password to verify the transmission.



Note: All virtual routers in the VRRP group must be configured the same: authentication must be enabled with the same password or authentication is disabled.

Configure simple authentication with the following command in the VRRP mode:

| Task | Command Syntax | Command Mode |
|-----------------------------------|--|----------------|
| Configure a simple text password. | authentication-type simple <i>[encryption-type] password</i> Parameters: <i>encryption-type</i> : 0 indicates unencrypted; 7 indicates encrypted <i>password</i> : plain text | INTERFACE-VRID |

Figure 54-9. Command Example: authentication-type

```
FTOS(conf-if-gi-1/1-vrid-111)#authentication-type ?
FTOS(conf-if-gi-1/1-vrid-111)#authentication-type simple 7 force10
```

Encryption type (encrypted) Password

Figure 54-10. Command Example: show config in VRID mode with a Simple Password Configured

```
FTOS(conf-if-gi-1/1-vrid-111)#show conf
!
vrrp-group 111
 authentication-type simple 7 387a7f2df5969da4 ← Encrypted password
 priority 255
 virtual-address 10.10.10.1
 virtual-address 10.10.10.2
 virtual-address 10.10.10.3
 virtual-address 10.10.10.10
FTOS(conf-if-gi-1/1-vrid-111)#
```

Disable Preempt

The preempt command is enabled by default, and it forces the system to change the MASTER router if another router with a higher priority comes online.

Prevent the BACKUP router with the higher priority from becoming the MASTER router by disabling preempt.



Note: All virtual routers in the VRRP group must be configured the same: all configured with preempt enabled or configured with preempt disabled.

Since preempt is enabled by default, disable the preempt function with the following command in the VRRP mode. Re-enable preempt by entering the preempt command. When preempt is enabled, it does not display in the show commands, because it is a default setting.,

| Task | Command Syntax | Command Mode |
|---|-------------------------|----------------|
| Prevent any BACKUP router with a higher priority from becoming the MASTER router. | <code>no preempt</code> | INTERFACE-VRID |

Figure 54-11. Command Example: no preempt

```
FTOS(conf-if-gi-1/1)#vrrp-group 111
FTOS(conf-if-gi-1/1-vrid-111)#no preempt
FTOS(conf-if-gi-1/1-vrid-111)#show conf
```

Figure 54-12. Command Example Display: show config in VRID mode

```
FTOS(conf-if-gi-1/1-vrid-111)#show conf
!
vrrp-group 111
 authentication-type simple 7 387a7f2df5969da4
 no preempt
 priority 255
 virtual-address 10.10.10.1
 virtual-address 10.10.10.2
 virtual-address 10.10.10.3
 virtual-address 10.10.10.10
 FTOS(conf-if-gi-1/1-vrid-111)#
```

Change the Advertisement interval

By default, the MASTER router transmits a VRRP advertisement to all members of the VRRP group every 1 second, indicating it is operational and is the MASTER router. If the VRRP group misses 3 consecutive advertisements, then the election process begins and the BACKUP virtual router with the highest priority transitions to MASTER.



Note: Dell Force10 recommends you to increase the VRRP advertisement interval to a value higher than the default value of 1 second to avoid throttling VRRP advertisement packets. If you do change the time interval between VRRP advertisements on one router, you must change it on all participating routers.

Change that advertisement interval with the following command in the VRRP mode:

| Task | Command Syntax | Command Mode |
|--|---|----------------|
| Change the advertisement interval setting. | advertise-interval <i>seconds</i> Range: 1-255 seconds Default: 1 second | INTERFACE-VRID |

Figure 54-13. Command Example: advertise-interval

```
FTOS(conf-if-gi-1/1)#vrrp-group 111
FTOS(conf-if-gi-1/1-vrid-111)#advertise-interval 10
FTOS(conf-if-gi-1/1-vrid-111)#
```

Figure 54-14. Command Example Display: advertise-interval in VRID mode

```
FTOS(conf-if-gi-1/1-vrid-111)#show conf
!
vrrp-group 111
  advertise-interval 10
  authentication-type simple 7 387a7f2df5969da4
  no preempt
  priority 255
  virtual-address 10.10.10.1
  virtual-address 10.10.10.2
  virtual-address 10.10.10.3
  virtual-address 10.10.10.10
FTOS(conf-if-gi-1/1-vrid-111)#
```

Track an Interface or Object

Set FTOS to monitor the state of any interface according to the Virtual group. Each VRRP group can track up to 12 interfaces, which may affect the priority of the VRRP group. If the tracked interface goes down, the VRRP group's priority is decreased by a default value of 10 (also known as cost). If the tracked interface's state goes up, the VRRP group's priority is increased by 10.

Each VRRP group can track changes in the status of up to 12 interfaces and up to 20 additional objects, which may affect the priority of the VRRP group. If a tracked interface or object goes down, the VRRP group's priority is decreased by a default value of 10 (also known as cost). If the state of a tracked interface or object goes up, the VRRP group's priority is increased by 10.

The lowered priority of the VRRP group may trigger an election. As the Master/Backup VRRP routers are selected based on the VRRP group's priority, tracking features ensure that the best VRRP router is the Master for that group. The sum of all the costs of all the tracked interfaces must be less than the configured priority on the VRRP group. If the VRRP group is configured as Owner router (priority 255), tracking for that group is disabled, irrespective of the state of the tracked interfaces. The priority of the owner group always remains at 255.

For a virtual group, you can track the line-protocol state or the routing status of any of the following interfaces with the **interface** *interface* parameter:

- 1-Gigabit Ethernet: Enter **gigabitethernet** *slot/port* in the **track interface** command (see Step 1 below).

- 10-Gigabit Ethernet: Enter **tengigabitethernet** *slot/port*.
- Port channel: Enter **port-channel** *number*, where valid port-channel numbers are:
 - For the C-Series and S-Series, 1 to 128
 - For the E-Series: 1 to 32 for EtherScale, 1 to 255 for TeraScale, and 1 to 512 for ExaScale
- SONET: Enter **sonet** *slot/port*.
- VLAN: Enter **vlan** *vlan-id*, where valid VLAN IDs are from 1 to 4094.

For a virtual group, you can also track the status of a configured object (**track** *object-id* command) by entering its object number.

Note that you can configure a tracked object for a VRRP group (using the **track** *object-id* command in INTERFACE-VRID mode) before you actually create the tracked object (using a **track** *object-id* command in CONFIGURATION mode). However, no changes in the VRRP group's priority will occur until the tracked object is defined and determined to be down.

In addition, if you configure a VRRP group on an interface that belongs to a VRF instance and later configure object tracking on an interface for the VRRP group, the tracked interface must belong to the VRF instance.

To track an interface, use the following command in the VRRP mode:

| Task | Command Syntax | Command Mode |
|--|--|------------------------|
| Monitor an interface and, optionally, set a value to be subtracted from the interface's VRRP group priority. | track <i>interface</i> [priority-cost <i>cost</i>] Cost Range: 1-254 Default: 10 | INTERFACE-VRID |
| (Optional) Display the configuration and UP or DOWN state of tracked objects, including the client (VRRP group) that is tracking an object's state. | show track | EXEC EXEC Privilege |
| (Optional) Display the configuration and UP or DOWN state of tracked interfaces and objects in VRRP groups, including the time since the last change in an object's state. | show vrrp | EXEC EXEC Privilege |
| (Optional) Display the configuration of tracked objects in VRRP groups on a specified interface. | show running-config interface <i>interface</i> | EXEC EXEC Privilege |

The sum of all the costs for all tracked interfaces must be less than the configured priority of the VRRP group.

Figure 54-15. Command Example: track

```
FTOS(conf-if-gi-1/1)#vrrp-group 111
FTOS(conf-if-gi-1/1-vrid-111)#track gigabitethernet 1/2
FTOS(conf-if-gi-1/1-vrid-111)#
```

Figure 54-16. Command Example Display: track in VRID mode

```
FTOS(conf-if-gi-1/1-vrid-111)#show conf
!
vrrp-group 111
  advertise-interval 10
  authentication-type simple 7 387a7f2df5969da4
  no preempt
  priority 255
  track GigabitEthernet 1/2
  virtual-address 10.10.10.1
  virtual-address 10.10.10.2
  virtual-address 10.10.10.3
  virtual-address 10.10.10.10
FTOS(conf-if-gi-1/1-vrid-111)#
```

Figure 54-17. Command Example: show track

```
FTOS#show track

Track 2
  IPv6 route 2040::/64 metric threshold
  Metric threshold is Up (STATIC/0/0)
  5 changes, last change 00:02:16
  Metric threshold down 255 up 254
  First-hop interface is GigabitEthernet 13/2
  Tracked by:
    VRRP GigabitEthernet 7/30 IPv6 VRID 1

Track 3
  IPv6 route 2050::/64 reachability
  Reachability is Up (STATIC)
  5 changes, last change 00:02:16
  First-hop interface is GigabitEthernet 13/2
  Tracked by:
    VRRP GigabitEthernet 7/30 IPv6 VRID 1
```

Figure 54-18. Command Example: show vrrp

```
FTOS#show vrrp
-----

GigabitEthernet 7/30, IPv6 VRID: 1, Version: 3, Net: fe80::201:e8ff:fe01:95cc
VRF: 0 default-vrf
State: Master, Priority: 100, Master: fe80::201:e8ff:fe01:95cc (local)
Hold Down: 0 centisec, Preempt: TRUE, AdvInt: 100 centisec
Accept Mode: FALSE, Master AdvInt: 100 centisec
Adv rcvd: 0, Bad pkts rcvd: 0, Adv sent: 310
Virtual MAC address:
  00:00:5e:00:02:01
Virtual IP address:
  2007::1 fe80::1
Tracking states for 2 resource Ids:
  2 - Up IPv6 route, 2040::/64, priority-cost 20, 00:02:11
  3 - Up IPv6 route, 2050::/64, priority-cost 30, 00:02:11
```

Figure 54-19. Command Example: show running-config interface

```

FTOS#show running-config interface gigabitethernet 7/30

interface GigabitEthernet 7/30
  no ip address
  ipv6 address 2007::30/64

  vrrp-ipv6-group 1
    track 2 priority-cost 20
    track 3 priority-cost 30
    virtual-address 2007::1
    virtual-address fe80::1
  no shutdown

```

VRRP initialization delay

VRRP initialization delay is supported on the **S4810** and **S4820T** only.

When configured, VRRP is enabled immediately upon system reload or boot. VRRP initialization can be delayed to allow IGP and EGP protocols to be enabled prior to selecting the VRRP Master. This delay ensures that VRRP initializes with no errors or conflicts. The delay can be configured for up to 15 minutes, after which VRRP enables normally.

The delay timer is set on individual interfaces and is supported on all physical interfaces, VLANs and LAGs.

When both CLIs are configured, the later timer rules the VRRP enabling. For example, if `vrrp delay reload 600` and `vrrp delay minimum 300`, the following behavior occurs:

- When the system reloads, VRRP waits 600 seconds (10 minutes) to bring up VRRP on all interfaces that are up and configured for vrrp.
- When an interface comes up and becomes operational, the system waits 300 seconds (5 minutes) to bring up VRRP on that interface.

| Task | Command Syntax | Command Mode |
|--|--|--------------|
| Set the delay time for VRRP initialization on an individual interface. This is the gap between an interface coming up and being operational, and VRRP enabling. | <code>vrrp delay minimum <i>seconds</i></code> Seconds range: 0-900 Default: 0 | INTERFACE |
| Set the delay time for VRRP initialization on all the interfaces in the system configured for VRRP. This is the gap between system boot up completion and VRRP enabling. | <code>vrrp delay reload <i>seconds</i></code> Seconds range: 0-900 Default: 0 | INTERFACE |

Sample Configurations

VRRP for IPv4 Configuration

The configuration in Figure 54-20 shows how to enable IPv4 VRRP. This example does not contain comprehensive directions and is intended to provide guidance for only a typical VRRP configuration. You can copy and paste from the example to your CLI. Be sure you make the necessary changes to support your own IP addresses, interfaces, names, etc. Figure 54-20 shows the VRRP topology created with the CLI configuration in Figure 54-22.

Figure 54-20. VRRP for IPv4 Topology

```
R2#show vrrp
-----
GigabitEthernet 2/31, VRID: 99, Net: 10.1.1.1
State: Master, Priority: 100, Master: 10.1.1.1 (local)
Hold Down: 0 sec, Preempt: TRUE, AdvInt: 1 sec
Adv rcvd: 0, Bad pkts rcvd: 0, Adv sent: 661, Gratuitous ARP sent: 1
Virtual MAC address:
00:00:5e:00:01:63
Virtual IP address:
10.1.1.3
Authentication: (none)
R2#
```

State Master: R2 was the first interface configured with VRRP

Virtual MAC is automatically assigned and is the same on both Routers

```
R3#show vrrp
-----
GigabitEthernet 3/21, VRID: 99, Net: 10.1.1.1
State: Backup, Priority: 100, Master: 10.1.1.1 (local)
Hold Down: 0 sec, Preempt: TRUE, AdvInt: 1 sec
Adv rcvd: 331, Bad pkts rcvd: 0, Adv sent: 0, Gratuitous ARP sent: 0
Virtual MAC address:
00:00:5e:00:01:63
Virtual IP address:
10.1.1.3
Authentication: (none)
R3#
```

State Backup: R3 was the second interface configured with VRRP

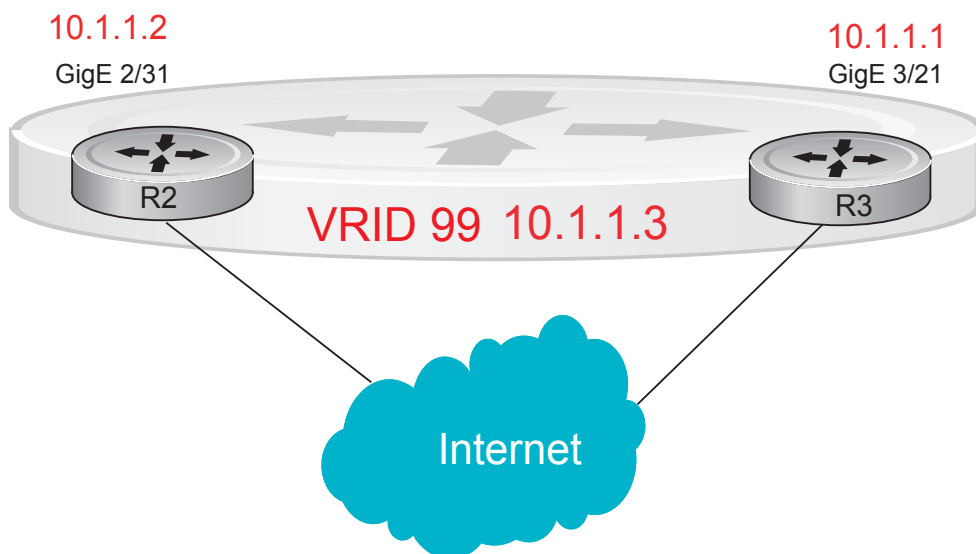

Figure 54-21. Configure VRRP for IPv4 Router 2

```

R2(conf)#int gi 2/31
R2(conf-if-gi-2/31)#ip address 10.1.1.1/24
R2(conf-if-gi-2/31)#vrrp-group 99
R2(conf-if-gi-2/31-vrid-99)#priority 200
R2(conf-if-gi-2/31-vrid-99)#virtual 10.1.1.3
R2(conf-if-gi-2/31-vrid-99)#no shut
R2(conf-if-gi-2/31)#show conf
!
interface GigabitEthernet 2/31
 ip address 10.1.1.1/24
!
 vrrp-group 99
  priority 200
  virtual-address 10.1.1.3
  no shutdown
R2(conf-if-gi-2/31)#end

R2#show vrrp
-----
GigabitEthernet 2/31, VRID: 99, Net: 10.1.1.1
State: Master, Priority: 200, Master: 10.1.1.1 (local)
Hold Down: 0 sec, Preempt: TRUE, AdvInt: 1 sec
Adv rcvd: 0, Bad pkts rcvd: 0, Adv sent: 817, Gratuitous ARP sent: 1
Virtual MAC address:
 00:00:5e:00:01:63
Virtual IP address:
 10.1.1.3
Authentication: (none)
R2#
Router 3
R3(conf)#int gi 3/21
R3(conf-if-gi-3/21)#ip address 10.1.1.2/24
R3(conf-if-gi-3/21)#vrrp-group 99
R3(conf-if-gi-3/21-vrid-99)#virtual 10.1.1.3
R3(conf-if-gi-3/21-vrid-99)#no shut
R3(conf-if-gi-3/21)#show conf
!
interface GigabitEthernet 3/21
 ip address 10.1.1.1/24
!
 vrrp-group 99
  virtual-address 10.1.1.3
  no shutdown
R3(conf-if-gi-3/21)#end
R3#show vrrp
-----
GigabitEthernet 3/21, VRID: 99, Net: 10.1.1.2
State: Backup, Priority: 100, Master: 10.1.1.1
Hold Down: 0 sec, Preempt: TRUE, AdvInt: 1 sec
Adv rcvd: 698, Bad pkts rcvd: 0, Adv sent: 0, Gratuitous ARP sent: 0
Virtual MAC address:
 00:00:5e:00:01:63
Virtual IP address:
 10.1.1.3
Authentication: (none)

```

VRRP for IPv6 Configuration

Figure 54-22 shows an example of a VRRP for IPv6 configuration in which the IPv6 VRRP group consists of two routers. This example does not contain comprehensive directions and is intended to provide guidance for only a typical VRRP configuration. You can copy and paste from the example to your CLI. Be sure you make the necessary changes to support your own IP addresses, interfaces, names, etc. Figure 54-22 shows the VRRP for IPv6 topology with the CLI configuration.

Figure 54-22. Configure VRRP for IPv6

Master State: Although both R2 and R3 have the same priority (100), R2 is the master in the VRRP group because the R2 interface has a higher IPv6 address. →

Virtual MAC is automatically assigned and is the same on both Routers →

You must configure both a virtual IPv6 address and a virtual link local (fe80) address for an IPv6 VRRP group →

```

R2#show vrrp
-----
GigabitEthernet 0/0, IPv6 VRID: 10, Net: fe80::201:e8ff:fe6a:c59f
VRF: 0 default-vrf
State: Master, Priority: 100, Master: fe80::201:e8ff:fe6a:c59f (local)
Hold Down: 0 centisec, Preempt: TRUE, AdvInt: 100 centisec
Accept Mode: FALSE, Master AdvInt: 100 centisec
Adv rcvd: 0, Bad pkts rcvd: 0, Adv sent: 135
Virtual MAC address:
00:00:5e:00:02:0a
Virtual IP address:
1::10 fe80::10
R2#
    
```

Backup State: R3 is the backup in the VRRP group because the R3 interface has a lower IPv6 address. →

Virtual MAC is automatically assigned and is the same on both Routers →

You must configure both a virtual IPv6 address and a virtual link local (fe80) address for an IPv6 VRRP group →

```

R3#show vrrp
-----
GigabitEthernet 1/0, IPv6 VRID: 10, Net: fe80::201:e8ff:fe6b:1845
VRF: 0 default-vrf
State: Backup, Priority: 100, Master: fe80::201:e8ff:fe6a:c59f
Hold Down: 0 centisec, Preempt: TRUE, AdvInt: 100 centisec
Accept Mode: FALSE, Master AdvInt: 100 centisec
Adv rcvd: 0, Bad pkts rcvd: 0, Adv sent: 135
Virtual MAC address:
00:00:5e:00:02:0a
Virtual IP address:
1::10 fe80::10
R3#
    
```

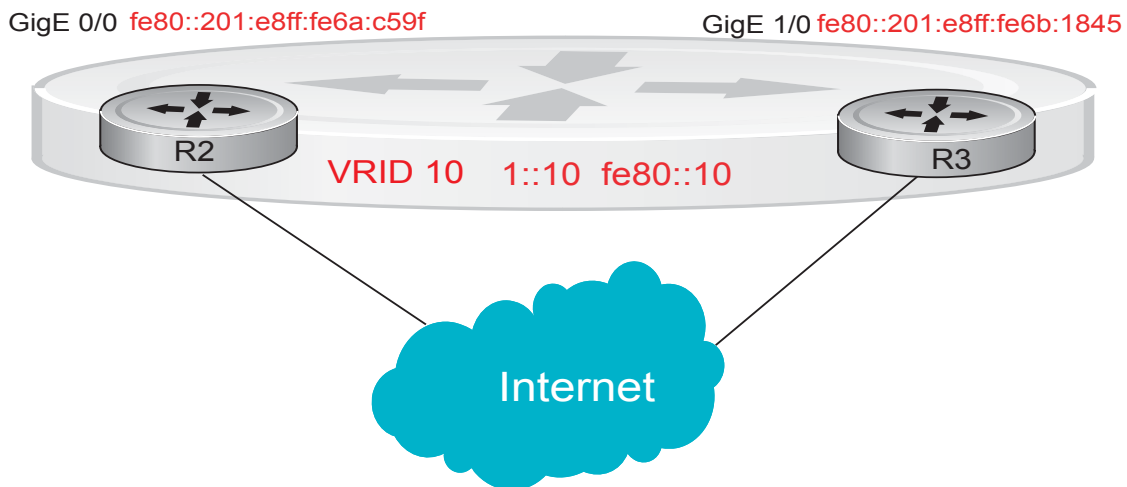

Note: In a VRRP or VRRPv3 group, if two routers come up with the same priority and another router already has MASTER status, the router with master status continues to be master even if one of two routers has a higher IP or IPv6 address.

Figure 54-23. Configure VRRP for IPv6**Router 2**

```
R2(conf)#interface gigabitEthernet 0/0
R2(conf-if-gi-0/0)#no ip address
R2(conf-if-gi-0/0)#ipv6 address 1::1/64
R2(conf-if-gi-0/0)#vrrp-group 10
R2(conf-if-gi-0/0-vrid-10)#virtual-address fe80::10
R2(conf-if-gi-0/0-vrid-10)#virtual-address 1::10
R2(conf-if-gi-0/0-vrid-10)#no shutdown
R2(conf-if-gi-0/0)#show config
interface GigabitEthernet 0/0
  ipv6 address 1::1/64
  vrrp-group 10
    priority 100
    virtual-address fe80::10
    virtual-address 1::10
  no shutdown
R2(conf-if-gi-0/0)#end
```

```
R2#show vrrp
```

```
-----
GigabitEthernet 0/0, IPv6 VRID: 10, Version: 3, Net:fe80::201:e8ff:fe6a:c59f
VRF: 0 default-vrf
State: Master, Priority: 100, Master: fe80::201:e8ff:fe6a:c59f (local)
Hold Down: 0 centisec, Preempt: TRUE, AdvInt: 100 centisec
Accept Mode: FALSE, Master AdvInt: 100 centisec
Adv rcvd: 0, Bad pkts rcvd: 0, Adv sent: 135
Virtual MAC address:
00:00:5e:00:02:0a
Virtual IP address:
1::10 fe80::10
```

Router 3

```
R3(conf)#interface gigabitEthernet 1/0
R3(conf-if-gi-1/0)#no ipv6 address
R3(conf-if-gi-1/0)#ipv6 address 1::2/64
R3(conf-if-gi-1/0)#vrrp-group 10
R3(conf-if-gi-1/0-vrid-10)#virtual-address fe80::10
R3(conf-if-gi-1/0-vrid-10)#virtual-address 1::10
R3(conf-if-gi-1/0-vrid-10)#no shutdown
R3(conf-if-gi-1/0)#show config
interface GigabitEthernet 1/0
  ipv6 address 1::2/64
  vrrp-group 10
    priority 100
    virtual-address fe80::10
    virtual-address 1::10
  no shutdown
R3(conf-if-gi-1/0)#end
```

```
R3#show vrrp
```

```
-----
GigabitEthernet 1/0, IPv6 VRID: 10, Version: 3, Net:
fe80::201:e8ff:fe6b:1845
VRF: 0 default-vrf
State: Backup, Priority: 100, Master: fe80::201:e8ff:fe6a:c59f
Hold Down: 0 centisec, Preempt: TRUE, AdvInt: 100 centisec
Accept Mode: FALSE, Master AdvInt: 100 centisec
Adv rcvd: 11, Bad pkts rcvd: 0, Adv sent: 0
Virtual MAC address:
00:00:5e:00:02:0a
```

You must configure a virtual link local (fe80) address for each VRRPv3 group created for an interface. The VRRPv3 group becomes active as soon as you configure the link local address. Afterwards, you can configure the group's virtual IPv6 address.

The virtual IPv6 address you configure should be the same as the IPv6 subnet to which the interface belongs.

Although R2 and R3 have the same default priority (100), R2 is elected master in the VRRPv3 group because the GigE 0/0 interface has a higher IPv6 address than the GigE 1/0 interface on R3.

VRRP in VRF Configuration

The example in this section shows how to enable VRRP operation in a VRF virtualized network for the following scenarios:

- Multiple VRFs on physical interfaces running VRRP
- Multiple VRFs on VLAN interfaces running VRRP

To view a VRRP in VRF configuration, use the **show** commands described in [Displaying a VRRP in VRF Configuration](#) on page 1066.

Non-VLAN Scenario

Figure 54-24. VRRP in VRF: Non-VLAN Example

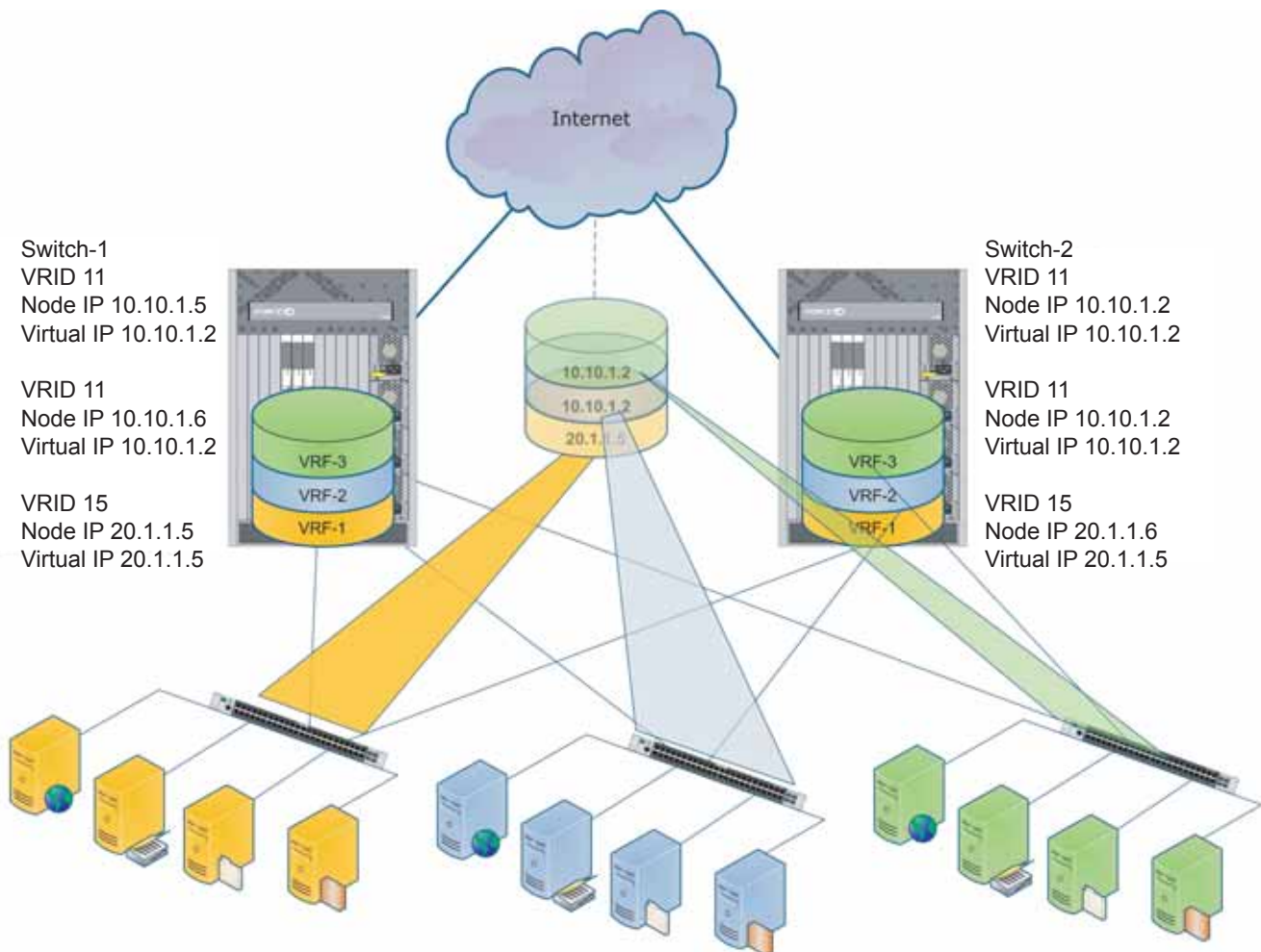

Figure 54-24 shows a typical use case in which three virtualized overlay networks are created by configuring three VRFs in two E-Series switches. The default gateway to reach the internet in each VRF is a static route with the next hop being the virtual IP address configured in VRRP. In this scenario, a single VLAN is associated with each VRF.

Both Switch-1 and Switch-2 have three VRF instances defined: VRF-1, VRF-2, and VRF-3. Each VRF has a separate physical interface to a LAN switch and an upstream VPN interface to connect to the Internet. Both Switch-1 and Switch-2 use VRRP groups on each VRF instance in order that there is one master and one backup router for each VRF. In VRF-1 and VRF-2, Switch-2 serves as owner-master of the VRRP group and Switch-1 serves as the backup. On VRF-3, Switch-1 is the owner-master and Switch-2 is the backup.

Note that in VRF-1 and VRF-2 on Switch-2, the virtual IP and node IP address, subnet, and VRRP group are the same. On Switch-1, the virtual IP address, subnet, and VRRP group are the same in VRF-1 and VRF-2, but the IP address of the node interface is unique. There is no requirement for the virtual IP and node IP addresses to be the same in VRF-1 and VRF-2; similarly, there is no requirement for the IP addresses to be different. In VRF-3, the node IP addresses and subnet are unique.

Figure 54-25. VRRP in VRF: Switch-1 Non-VLAN Configuration

Switch-1

```
S1(conf)#ip vrf default-vrf 0
!
S1(conf)#ip vrf VRF-1 1
!
S1(conf)#ip vrf VRF-2 2
!
S1(conf)#ip vrf VRF-3 3
!
S1(conf)#interface GigabitEthernet 12/1
S1(conf-if-gi-12/1)#ip vrf forwarding VRF-1
S1(conf-if-gi-12/1)#ip address 10.10.1.5/24
S1(conf-if-gi-12/1)#vrrp-group 11
% Info: The VRID used by the VRRP group 11 in VRF 1 will be 177.
S1(conf-if-gi-12/1-vrid-101)#priority 100
S1(conf-if-gi-12/1-vrid-101)#virtual-address 10.10.1.2
S1(conf-if-gi-12/1)#no shutdown
!
S1(conf)#interface GigabitEthernet 12/2
S1(conf-if-gi-12/2)#ip vrf forwarding VRF-2
S1(conf-if-gi-12/2)#ip address 10.10.1.6/24
S1(conf-if-gi-12/2)#vrrp-group 11
% Info: The VRID used by the VRRP group 11 in VRF 2 will be 178.
S1(conf-if-gi-12/2-vrid-101)#priority 100
S1(conf-if-gi-12/2-vrid-101)#virtual-address 10.10.1.2
S1(conf-if-gi-12/2)#no shutdown
!
S1(conf)#interface GigabitEthernet 12/3
S1(conf-if-gi-12/3)#ip vrf forwarding VRF-3
S1(conf-if-gi-12/3)#ip address 20.1.1.5/24
S1(conf-if-gi-12/3)#vrrp-group 15
% Info: The VRID used by the VRRP group 15 in VRF 3 will be 243.
S1(conf-if-gi-12/3-vrid-105)#priority 255
S1(conf-if-gi-12/3-vrid-105)#virtual-address 20.1.1.5
S1(conf-if-gi-12/3)#no shutdown
```

Figure 54-26. VRRP in VRF: Switch-2 Non-VLAN Configuration

Switch-2

```
S2(conf)#ip vrf default-vrf 0
!
S2(conf)#ip vrf VRF-1 1
!
S2(conf)#ip vrf VRF-2 2
!
S2(conf)#ip vrf VRF-3 3
!
S2(conf)#interface GigabitEthernet 12/1
S2(conf-if-gi-12/1)#ip vrf forwarding VRF-1
S2(conf-if-gi-12/1)#ip address 10.10.1.2/24
S2(conf-if-gi-12/1)#vrrp-group 11
% Info: The VRID used by the VRRP group 11 in VRF 1 will be 177.
S2(conf-if-gi-12/1-vrid-101)#priority 255
S2(conf-if-gi-12/1-vrid-101)#virtual-address 10.10.1.2
S2(conf-if-gi-12/1)#no shutdown
!
S2(conf)#interface GigabitEthernet 12/2
S2(conf-if-gi-12/2)#ip vrf forwarding VRF-2
S2(conf-if-gi-12/2)#ip address 10.10.1.2/24
S2(conf-if-gi-12/2)#vrrp-group 11
% Info: The VRID used by the VRRP group 11 in VRF 2 will be 178.
S2(conf-if-gi-12/2-vrid-101)#priority 255
S2(conf-if-gi-12/2-vrid-101)#virtual-address 10.10.1.2
S2(conf-if-gi-12/2)#no shutdown
!
S2(conf)#interface GigabitEthernet 12/3
S2(conf-if-gi-12/3)#ip vrf forwarding VRF-3
S2(conf-if-gi-12/3)#ip address 20.1.1.6/24
S2(conf-if-gi-12/3)#vrrp-group 15
% Info: The VRID used by the VRRP group 15 in VRF 3 will be 243.
S2(conf-if-gi-12/3-vrid-105)#priority 100
S2(conf-if-gi-12/3-vrid-105)#virtual-address 20.1.1.5
S2(conf-if-gi-12/3)#no shutdown
```

VLAN Scenario

In another scenario, VRF-1, VRF-2, and VRF-3 use a single physical interface with multiple tagged VLANs (instead of separate physical interfaces) to connect to the LAN. In this case, three VLANs are configured: VLAN-100, VLAN-200, and VLAN-300. Each VLAN is a member of one VRF. A physical interface (gigabitethernet 0/1) attaches to the LAN and is configured as a tagged interface in VLAN-100, VLAN-200, and VLAN-300. The rest of this user case is the same as the non-VLAN scenario.

This VLAN scenario often occurs in a service-provider network in which VLAN tags are configured for traffic from multiple customers on customer-premises equipment (CPE), and separate VRF instances associated with each VLAN are configured on the provider edge (PE) router in the point-of-presence (POP).

Figure 54-27. VRRP in VRF: Switch-1 VLAN Configuration**Switch-1**

```
S1(conf)#ip vrf VRF-1 1
!
S1(conf)#ip vrf VRF-2 2
!
S1(conf)#ip vrf VRF-3 3
!
S1(conf)#interface GigabitEthernet 12/4
S1(conf-if-gi-12/4)#no ip address
S1(conf-if-gi-12/4)#switchport
S1(conf-if-gi-12/4)#no shutdown
!
S1(conf-if-gi-12/4)#interface vlan 100
S1(conf-if-vl-100)#ip vrf forwarding VRF-1
S1(conf-if-vl-100)#ip address 10.10.1.5/24
S1(conf-if-vl-100)#tagged gigabitethernet 12/4
S1(conf-if-vl-100)#vrrp-group 11
% Info: The VRID used by the VRRP group 11 in VRF 1 will be 177.
S1(conf-if-vl-100-vrid-101)#priority 100
S1(conf-if-vl-100-vrid-101)#virtual-address 10.10.1.2
S1(conf-if-vl-100)#no shutdown
!
S1(conf-if-gi-12/4)#interface vlan 200
S1(conf-if-vl-200)#ip vrf forwarding VRF-2
S1(conf-if-vl-200)#ip address 10.10.1.6/24
S1(conf-if-vl-200)#tagged gigabitethernet 12/4
S1(conf-if-vl-200)#vrrp-group 11
% Info: The VRID used by the VRRP group 11 in VRF 2 will be 178.
S1(conf-if-vl-200-vrid-101)#priority 100
S1(conf-if-vl-200-vrid-101)#virtual-address 10.10.1.2
S1(conf-if-vl-200)#no shutdown
!
S1(conf-if-gi-12/4)#interface vlan 300
S1(conf-if-vl-300)#ip vrf forwarding VRF-3
S1(conf-if-vl-300)#ip address 20.1.1.5/24
S1(conf-if-vl-300)#tagged gigabitethernet 12/4
S1(conf-if-vl-300)#vrrp-group 15
% Info: The VRID used by the VRRP group 15 in VRF 3 will be 243.
S1(conf-if-vl-300-vrid-101)#priority 255
S1(conf-if-vl-300-vrid-101)#virtual-address 20.1.1.5
S1(conf-if-vl-300)#no shutdown
```

Figure 54-28. VRRP in VRF: Switch-2 VLAN Configuration

Switch-2

```
S2(conf)#ip vrf VRF-1 1
!
S2(conf)#ip vrf VRF-2 2
!
S2(conf)#ip vrf VRF-3 3
!
S2(conf)#interface GigabitEthernet 12/4
S2(conf-if-gi-12/4)#no ip address
S2(conf-if-gi-12/4)#switchport
S2(conf-if-gi-12/4)#no shutdown
!
S2(conf-if-gi-12/4)#interface vlan 100
S2(conf-if-vl-100)#ip vrf forwarding VRF-1
S2(conf-if-vl-100)#ip address 10.10.1.2/24
S2(conf-if-vl-100)#tagged gigabitethernet 12/4
S2(conf-if-vl-100)#vrrp-group 11
% Info: The VRID used by the VRRP group 11 in VRF 1 will be 177.
S2(conf-if-vl-100-vrid-101)#priority 255
S2(conf-if-vl-100-vrid-101)#virtual-address 10.10.1.2
S2(conf-if-vl-100)#no shutdown
!
S2(conf-if-gi-12/4)#interface vlan 200
S2(conf-if-vl-200)#ip vrf forwarding VRF-2
S2(conf-if-vl-200)#ip address 10.10.1.2/24
S2(conf-if-vl-200)#tagged gigabitethernet 12/4
S2(conf-if-vl-200)#vrrp-group 11
% Info: The VRID used by the VRRP group 11 in VRF 2 will be 178.
S2(conf-if-vl-200-vrid-101)#priority 255
S2(conf-if-vl-200-vrid-101)#virtual-address 10.10.1.2
S2(conf-if-vl-200)#no shutdown
!
S2(conf-if-gi-12/4)#interface vlan 300
S2(conf-if-vl-300)#ip vrf forwarding VRF-3
S2(conf-if-vl-300)#ip address 20.1.1.6/24
S2(conf-if-vl-300)#tagged gigabitethernet 12/4
S2(conf-if-vl-300)#vrrp-group 15
% Info: The VRID used by the VRRP group 15 in VRF 3 will be 243.
S2(conf-if-vl-300-vrid-101)#priority 100
S2(conf-if-vl-300-vrid-101)#virtual-address 20.1.1.5
S2(conf-if-vl-300)#no shutdown
```

Displaying a VRRP in VRF Configuration

To display information on a VRRP group that is configured on an interface that belongs to a VRF instance, enter the **show running-config track [interface *interface*]** command:

Figure 54-29. Command Example: show running-config track interface

```
FTOS#show running-config interface gigabitethernet 13/4

interface GigabitEthernet 13/4
  ip vrf forwarding red
  ip address 192.168.0.1/24

  vrrp-group 4
    virtual-address 192.168.0.254
  no shutdown
```

To display information on the VRRP groups configured on interfaces that belong to a VRF instance, enter the **show vrrp vrf [vrf *instance*]** command:

Figure 54-30. Command Example: show vrrp vrf

```
FTOS#show vrrp vrf red
-----
GigabitEthernet 13/4, IPv4 Vrrp-group: 4, VRID: 65, Version: 2, Net: 192.168.0.1
VRF: 1 red
State: Master, Priority: 100, Master: 192.168.0.1 (local)
Hold Down: 0 sec, Preempt: TRUE, AdvInt: 1 sec
Adv rcvd: 0, Bad pkts rcvd: 0, Adv sent: 9, Gratuitous ARP sent: 1
Virtual MAC address:
  00:00:5e:00:01:41
Virtual IP address:
  192.168.0.254
Authentication: (none)
```

S-Series Debugging and Diagnostics

The chapter contains the following major sections:

- Offline diagnostics
- Trace logs
- Last restart reason (S4810 and S4820T)
- show hardware commands (S4810 and S4820T)
- Environmental monitoring
- Buffer tuning
- Troubleshooting packet loss
- Application core dumps
- Mini core dumps
- TCP dumps

Offline diagnostics

The offline diagnostics test suite is useful for isolating faults and debugging hardware. The diagnostics tests are grouped into three levels:

- **Level 0**—Level 0 diagnostics check for the presence of various components and perform essential path verifications. In addition, they verify the identification registers of the components on the board.
- **Level 1**—A smaller set of diagnostic tests. Level 1 diagnostics perform status/self-test for all the components on the board and test their registers for appropriate values. In addition, they perform extensive tests on memory devices (e.g., SDRAM, flash, NVRAM, EEPROM) wherever possible.
- **Level 2**—The full set of diagnostic tests. Level 2 diagnostics are used primarily for on-board loopback tests and more extensive component diagnostics. Various components on the board are put into loopback mode, and test packets are transmitted through those components. These diagnostics also perform snake tests using VLAN configurations.

Important Points to Remember

- You can only perform offline diagnostics on an offline standalone unit or offline member unit of a stack of three or more. You cannot perform diagnostics on the management or standby unit in a stack of two or more ([Message 1](#)).

Message 1 Offline Diagnostics on Master/Standby Error

Running Diagnostics on master/standby unit is not allowed on stack.

- Perform offline diagnostics on one stack member at a time.
- Diagnostics only test connectivity, not the entire data path.
- Diagnostic results are stored on the flash of the unit on which you performed the diagnostics.
- When offline diagnostics are complete, the unit or stack member reboots automatically.

Running Offline Diagnostics

- Place the unit in the offline state using the `offline stack-unit` command from EXEC Privilege mode, as shown in [Figure 55-1](#). You cannot enter the command on a Master or Standby stack unit.



The system reboots when the off-line diagnostics complete. This is an automatic process. A warning message appears when the `offline stack-unit` command is implemented.

```
Warning - Diagnostic execution will cause stack-unit to reboot after completion of
diags.
```

```
Proceed with Offline-Diags [confirm yes/no]:y
```

Figure 55-1. Taking an S-Series Stack Unit Offline

```
FTOS#offline stack-unit 2
Warning - Diagnostic execution will cause stack-unit to reboot after completion of diags.
Proceed with Offline-Diags [confirm yes/no]:y
5w6d12h: %STKUNIT0-M:CP %CHMGR-2-STACKUNIT_DOWN: Stack unit 2 down - stack unit offline
5w6d12h: %STKUNIT0-M:CP %IFMGR-1-DEL_PORT: Removed port: Gi 2/1-48
FTOS#5w6d12h: %STKUNIT1-S:CP %IFMGR-1-DEL_PORT: Removed port: Gi 2/1-48
```

- Use the `show system brief` command from EXEC Privilege mode to confirm offline status, as shown in [Figure 55-2](#).

Figure 55-2. Verifying the Offline/Online Status of an S-Series Stack Unit

```
FTOS#show system brief | no-more

Stack MAC : 00:01:e8:d6:02:39

-- Stack Info --
Unit  UnitType   Status      ReqTyp      CurTyp      Version     Ports
-----
0  Standby      online      S25V        S25V        4.7.7.220   28
1  Management  offline    S50N        S50N        4.7.7.220   52
2  Member       online     S25P        S25P        4.7.7.220   28
3  Member       not present
4  Member       not present
5  Member       not present
6  Member       not present
7  Member       not present

-- Module Info --
Unit  Module No   Status      Module Type      Ports
-----
0  0           online     S50-01-10GE-2C   2
0  1           online     S50-01-12G-2S   2
1  0           online     S50-01-10GE-2P   2
1  1           online     S50-01-12G-2S   2
2  0           not present No Module         0
2  1           offline    S50-01-12G-2S   2

-- Power Supplies --
Unit  Bay   Status      Type
-----
0  0     up          AC
0  1     absent
1  0     up          AC
1  1     absent
2  0     up          AC
2  1     absent
```

3. Start diagnostics on the unit using the command `diag`, as shown in [Figure 55-3](#). When the tests are complete, the system displays [syslog Message 2](#), and automatically reboots the unit. Diagnostic results are printed to a file in the flash using the filename format `TestReport-SU-<stack-unit>.txt`.

Message 2 Offline Diagnostics Complete

```
FTOS#00:09:32 : Diagnostic test results are stored on file: flash:/TestReport-SU-1.txt
00:09:37: %S50N:1 %DIAGAGT-6-DA_DIAG_DONE: Diags finished on stack unit 1
Diags completed... Rebooting the system now!!!
```

As shown in [Figure 55-3](#) and [Figure 55-4](#), log messages differ somewhat when diagnostics are done on a standalone unit and on a stack member.

Figure 55-3. Running Offline Diagnostics on an S-Series Standalone Unit

```

FTOS#diag stack-unit 1 allevels
Warning - diagnostic execution will cause multiple link flaps on the peer side - advisable
to shut directly connected ports
Proceed with Diags [confirm yes/no]: yes
00:03:35: %S50N:1 %DIAGAGT-6-DA_DIAG_STARTED: Starting diags on stack unit 1
00:03:35 : Approximate time to complete these Diags ... 6 Min
S50N#00:09:32 : Diagnostic test results are stored on file: flash:/TestReport-SU-0.txt
00:09:37: %S50N:0 %DIAGAGT-6-DA_DIAG_DONE: Diags finished on stack unit 0
Diags completed... Rebooting the system now!!!

[reboot output omitted]

S50N#00:01:35: %STKUNIT0-M:CP %SYS-5-CONFIG_I: Configured from console by console
dir
Directory of flash:

 1  drw-      16384   Jan 01 1980 00:00:00 +00:00 .
 2  drwx       1536   Feb 29 1996 00:05:22 +00:00 ..
 3  drw-        512   Aug 15 1996 23:09:48 +00:00 TRACE_LOG_DIR
 4  d---        512   Aug 15 1996 23:09:52 +00:00 ADMIN_DIR
 5  -rw-       3854   Sep 24 1996 03:43:46 +00:00 startup-config
 6  -rw-      12632   Nov 05 2008 17:15:16 +00:00 TestReport-SU-1.txt

flash: 3104256 bytes total (3086336 bytes free)

```

Figure 55-4 shows the output of the master and member units when you run offline diagnostics on a member unit.

Figure 55-4. Running Offline Diagnostics on an S-Series Stack Member

```

[output from master unit]
FTOS#diag stack-unit 2
Warning - the stack unit will be pulled out of the stack for diagnostic execution
Proceed with Diags [confirm yes/no]: yes
Warning - diagnostic execution will cause multiple link flaps on the peer side - advisable
to shut directly connected ports
Proceed with Diags [confirm yes/no]: yes
FTOS#00:03:13: %S25P:2 %DIAGAGT-6-DA_DIAG_STARTED: Starting diags on stack unit 2
00:03:13 : Approximate time to complete these Diags ... 6 Min
00:03:13 : Diagnostic test results will be stored on stack unit 2 file: flash:/
TestReport-SU-2.txt
FTOS#00:03:35: %STKUNIT1-M:CP %CHMGR-2-STACKUNIT_DOWN: Stack unit 2 down - card removed
00:08:50: %STKUNIT1-M:CP %CHMGR-5-STACKUNITDETECTED: Stack unit 2 present
00:09:00: %STKUNIT1-M:CP %CHMGR-5-CHECKIN: Checkin from Stack unit 2 (type S25P, 28 ports)
00:09:00: %S25P:2 %CHMGR-0-PS_UP: Power supply 0 in unit 2 is up
00:09:00: %STKUNIT1-M:CP %CHMGR-5-STACKUNITUP: Stack unit 2 is up
[output from the console of the unit in which diagnostics are performed]
FTOS(stack-member-2)#
Diagnostic test results are stored on file: flash:/TestReport-SU-2.txt
Diags completed... Rebooting the system now!!!

```

4. View the results of the diagnostic tests using the command `show file flash://` from EXEC Privilege mode, as shown in [Figure 55-5](#).

Figure 55-5. Viewing the Results of Offline Diagnostics on a Standalone Unit

```
FTOS#show file flash://TestReport-SU-0.txt

*****S-Series Diagnostics*****
Stack Unit Board Serial Number : DL267160098
CPU Version : MPC8541, Version: 1.1
PLD Version : 5
Diag image based on build : E_MAIN4.7.7.206
Stack Unit Board Voltage levels - 3.300000 V, 2.500000 V, 1.800000 V, 1.250000 V, 1.200000
V, 2.000000 V
Stack Unit Board temperature : 26 Degree C
Stack Unit Number : 0

*****Stack Unit EEPROM INFO*****

*****MFG INFO*****

Data in Chassis Eeprom Mfg Info is listed as...
Vendor Id: 07
Country Code: 01
Date Code: 12172007
Serial Number: DL267160098
Part Number: 7590003600
Product Revision: B
Product Order Number: ${

***** LEVEL 0 DIAGNOSTICS*****

Test 0 - CPLD Presence Test ..... PASS
  Hardware PCB Revision is - Revision B
Test 1 - CPLD Hardware PCB Revision Test ..... PASS
Test 2.000 - CPLD Fan-0 Presence Test ..... PASS
Test 2.001 - CPLD Fan-1 Presence Test ..... PASS
Test 2.002 - CPLD Fan-2 Presence Test ..... PASS
Test 2.003 - CPLD Fan-3 Presence Test ..... PASS
Test 2.004 - CPLD Fan-4 Presence Test ..... PASS
Test 2.005 - CPLD Fan-5 Presence Test ..... PASS
Test 3.000 - CPLD Power Bay-0 Presence Test ..... PASS
Test 3.001 - CPLD Power Bay-1 Presence Test ..... NOT PRESENT
Test 4 - SDRAM Access Test ..... PASS
Test 5 - CPU Access Test ..... PASS
Test 6 - I2C Temp Access Test CPU Board ..... PASS
Test 7 - I2C Temp Access Test Main Board ..... PASS
Test 8 - RTC Access Test ..... PASS
--More--
```

Trace logs

In addition to the syslog buffer, FTOS buffers trace messages which are continuously written by various FTOS software tasks to report hardware and software events and status information. Each trace message provides the date, time, and name of the FTOS process. All messages are stored in a ring buffer and can be saved to a file either manually or automatically upon failover.

Auto Save on Crash or Rollover

Exception information on for master or standby units is stored in the **flash://TRACE_LOG_DIR** directory. This directory contains files that save trace information when there has been a task crash or timeout.

On a master unit, the **TRACE_LOG_DIR** files can be reached by FTP or by using the show file command from the **flash://TRACE_LOG_DIR** directory.

On a Standby unit, the **TRACE_LOG_DIR** files can be reached only by using the show file command from the **flash://TRACE_LOG_DIR** directory.



Note: Non-management member units do not support this functionality.

Last restart reason (S4810 and S4820T)

If an S4810 or S4820T system restarted for some reason (automatically or manually), the show system command output includes the reason for the restart. The following table shows the reasons displayed in the output and their corresponding causes.

Table 55-1. Line card restart causes and reasons

| Causes | Displayed Reasons |
|-----------------------------------|-------------------|
| Remote power cycle of the chassis | push button reset |
| reload | soft reset |
| reboot after a crash | soft reset |

Hardware watchdog timer

The hardware watchdog command automatically reboots an FTOS switch/router with a single RPM that is unresponsive. This is a last resort mechanism intended to prevent a manual power cycle.

Table 55-2. Hardware Watchdog Command

| Command | Description |
|-------------------|---|
| hardware watchdog | Enable the hardware watchdog mechanism. |

show hardware commands (S4810 and S4820T)

 **Note:** The show hardware command tree is supported on the S4810 and S4820T only.

The show hardware command tree consists of EXEC Privilege commands used with the S4810 and S4820T systems. These commands display information from a hardware sub-component and from hardware-based feature tables.

Table 55-3 lists the show hardware commands available as of the latest FTOS version on the S4810 and S4820T.

 **Note:** The show hardware commands should only be used under the guidance of Dell Force10 Technical Assistance Center.

Table 55-3. show hardware Commands

| Command | Description |
|--|---|
| show hardware stack-unit {0-11} cpu management statistics | View internal interface status of the stack-unit CPU port which connects to the external management interface. |
| show hardware stack-unit {0-11} cpu data-plane statistics | View driver-level statistics for the data-plane port on the CPU for the specified stack-unit. It provides insight into the packet types entering the CPU to see whether CPU-bound traffic is internal (IPC traffic) or network control traffic, which the CPU must process. |
| show hardware stack-unit {0-11} buffer total-buffer | View the modular packet buffers details per stack unit and the mode of allocation. |
| show hardware stack-unit {0-11} buffer unit {0-1} total-buffer | View the modular packet buffers details per unit and the mode of allocation. |
| show hardware stack-unit {0-11} buffer unit {0-1} port {1-64 all} buffer-info | View the forwarding plane statistics containing the packet buffer usage per port per stack unit. |
| show hardware stack-unit {0-11} buffer unit {0-1} port {1-64} queue {0-14 all} buffer-info | View the forwarding plane statistics containing the packet buffer statistics per COS per port. |
| show hardware stack-unit {0-11} cpu party-bus statistics | View input and output statistics on the party bus, which carries inter-process communication traffic between CPUs. |
| show hardware stack-unit {0-11} drops unit {0-1} port {1-64} | View the ingress and egress internal packet-drop counters, MAC counters drop, and FP packet drops for the stack unit on per port basis. It assists in identifying the stack unit/port pipe/port that may experience internal drops. |
| show hardware stack-unit {0-11} stack-port {0-64} | View the input and output statistics for a stack-port interface. |
| show hardware stack-unit {0-11} unit {0-1} counters | View the counters in the field processors of the stack unit. |
| show hardware stack-unit {0-11} unit {0-1} details | View the details of the the FP Devices, and Hi gig ports on the stack-unit. |
| show hardware stack-unit {0-11} unit {0-1} execute-shell-cmd {command} | Execute a specified bShell commands from the CLI without going into the bShell. |

Table 55-3. show hardware Commands

| Command | Description |
|---|--|
| show hardware stack-unit {0-11} unit {0-1} ipmc-replication | View the Multicast IPMC replication table from the bShell. |
| show hardware stack-unit {0-11} unit {0-1} port-stats [detail] | View the internal statistics for each port-pipe (unit) on per port basis. |
| show hardware stack-unit {0-11} unit {0-1} register | View the stack-unit internal registers for each port-pipe. |
| show hardware stack-unit {0-11} unit {0-1} table-dump {table name} | View the tables from the bShell through the CLI without going into the bShell. |

Environmental monitoring

The S4810 and S4820T components use environmental monitoring hardware to detect transmit power readings, receive power readings, and temperature updates. To receive periodic power updates, the enable optic-info-update interval command must be enabled. The output in [Figure 55-6](#) displays the environment status of the RPM.

Figure 55-6. show interfaces transceiver Command Example

```
FTOS#show interfaces
--  RPM Environment Status  --
Slot Status      Temp   Voltage
-----
 0  active        33C   ok
 1  not present
```

Recognize an overtemperature condition

An overtemperature condition occurs, for one of two reasons:

- The card genuinely is too hot.
- A sensor has malfunctioned.

Inspect cards adjacent to the one reporting the condition to discover the cause.

- If directly adjacent cards are not normal temperature, suspect a genuine overheating condition.
- If directly adjacent cards are normal temperature, suspect a faulty sensor.

When the system detects a genuine over-temperature condition, it powers off the card. To recognize this condition, look for the system messages in [Message 3](#).

Message 3 Over Temperature Condition System Messages

```
CHMGR-2-MAJOR_TEMP: Major alarm: chassis temperature high (temperature reaches or exceeds threshold of [value]C)
CHMGR-2-TEMP_SHUTDOWN_WARN: WARNING! temperature is [value]C; approaching shutdown threshold of [value]C
```

To view the programmed alarm thresholds levels, including the shutdown value, execute the show alarms threshold command shown in [Figure 55-7](#).

Figure 55-7. show alarms threshold Command Example

```
FTOS#show alarms threshold

-- Temperature Limits (deg C) --
-----
Linecard  Minor      Minor Off  Major      Major Off  Shutdown
RPM       75          70         80          77         85
FTOS#
```

Troubleshoot an overtemperature condition

To troubleshoot an over-temperature condition:

1. Use the show environment commands to monitor the temperature levels.
2. Check air flow through the system. On the C-Series, air flows sideways from right to left. Ensure the air ducts are clean and that all fans are working correctly.
3. Once the software has determined that the temperature levels are within normal limits, the card can be re-powered safely. Use the power-on command in EXEC mode to bring the line card back online.

In addition, Dell Force10 requires that you install blanks in all slots without a line card to control airflow for adequate system cooling.



Note: Exercise care when removing a card; if it has exceeded the major or shutdown thresholds, the card could be hot to the touch!

Recognize an under-voltage condition

If the system detects an under-voltage condition and declares an alarm. To recognize this condition, look for the system messages in [Message 4](#).

Message 4 Under-voltage Condition System Messages

```
%CHMGR-1-CARD_SHUTDOWN: Major alarm: Line card 2 down - auto-shutdown due to under voltage
```

This message in [Message 4](#) indicates that the specified card is not receiving enough power. In response, the system first shuts down Power over Ethernet (PoE). If the under-voltage condition persists, line cards are shut down, then RPMs.

Troubleshoot an under-voltage condition

To troubleshoot an under-voltage condition, check that the correct number of power supplies are installed and their Status LEDs are lit.

The SNMP traps and OIDs in [Table 55-4](#) provide information on S-Series environmental monitoring hardware and hardware components.

Table 55-4. SNMP Traps and OIDs

| OID String | OID Name | Description |
|---------------------------------------|-----------------------|---|
| Receiving power | | |
| .1.3.6.1.4.1.6027.3.10.1.2.5.1.6 | chSysPortXfpRecvPower | OID to display the receiving power of the connected optics. |
| Transmitting power | | |
| .1.3.6.1.4.1.6027.3.10.1.2.5.1.8 | chSysPortXfpTxPower | OID to display the transmitting power of the connected optics. |
| Temperature | | |
| .1.3.6.1.4.1.6027.3.10.1.2.5.1.7 | chSysPortXfpRecvTemp | OID to display the Temperature of the connected optics. Note: These OIDs will only be generated if the CLI command <code>enable optic-info-update-interval</code> is enabled. |
| Hardware MIB Buffer Statistics | | |
| .1.3.6.1.4.1.6027.3.16.1.1.4 | fpPacketBufferTable | View the modular packet buffers details per stack unit and the mode of allocation. |
| .1.3.6.1.4.1.6027.3.16.1.1.5 | fpStatsPerPortTable | View the forwarding plane statistics containing the packet buffer usage per port per stack unit. |
| .1.3.6.1.4.1.6027.3.16.1.1.6 | fpStatsPerCOSTable | View the forwarding plane statistics containing the packet buffer statistics per COS per port. |

Buffer tuning

Buffer Tuning allows you to modify the way your switch allocates buffers from its available memory, and helps prevent packet drops during a temporary burst of traffic. The S-Series ASICs implement the key functions of queuing, feature lookups, and forwarding lookups in hardware.

- Forwarding Processor (FP) ASICs provide Ethernet MAC functions, queueing and buffering, as well as store feature and forwarding tables for hardware-based lookup and forwarding decisions. 1G and 10G interfaces use different FPs.

Table 55-5 describes the type and number of ASICs per platform.

Table 55-5. ASICs by Platform

| Hardware | FP | CSF |
|------------------|----|-----|
| S50N, S50V | 2 | 0 |
| S25V, S25P, S25N | 1 | 0 |

You can tune buffers at three locations, as shown in Figure 55-8.

1. CSF – Output queues going from the CSF.
2. FP Uplink—Output queues going from the FP to the CSF IDP links.
3. Front-End Link—Output queues going from the FP to the front-end PHY.

All ports support eight queues, 4 for data traffic and 4 for control traffic. All 8 queues are tunable.

Physical memory is organized into cells of 128 bytes. The cells are organized into two buffer pools—dedicated buffer and dynamic buffer.

- **Dedicated buffer** is reserved memory that cannot be used by other interfaces on the same ASIC or by other queues on the same interface. This buffer is always allocated, and no dynamic recarving takes place based on changes in interface status. Dedicated buffers introduce a trade-off. They provide each interface with a guaranteed minimum buffer to prevent an overused and congested interface from starving all other interfaces. However, this minimum guarantee means the buffer manager does not reallocate the buffer to an adjacent congested interface, which means that in some cases, memory is underused.
- **Dynamic buffer** is shared memory that is allocated as needed, up to a configured limit. Using dynamic buffers provides the benefit of statistical buffer sharing. An interface requests dynamic buffers when its dedicated buffer pool is exhausted. The buffer manager grants the request based on three conditions:
 - The number of used and available dynamic buffers
 - The maximum number of cells that an interface can occupy
 - Available packet pointers (2k per interface). Each packet is managed in the buffer using a unique packet pointer. Thus, each interface can manage up to 2k packets.

You can configure dynamic buffers per port on both 1G and 10G FPs and per queue on CSFs. By default, the FP dynamic buffer allocation is 10 times oversubscribed. For the 48-port 1G card:

- Dynamic Pool= Total Available Pool(16384 cells) – Total Dedicated Pool = 5904 cells
- Oversubscription ratio = 10
- Dynamic Cell Limit Per port = $59040/29 = 2036$ cells

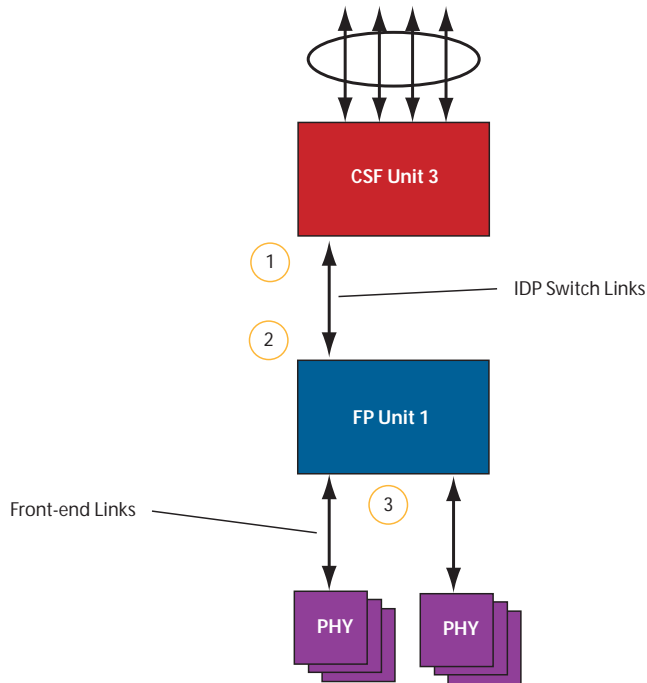
Figure 55-8. Buffer Tuning Points

Deciding to tune buffers

Dell Force10 recommends exercising caution when configuring any non-default buffer settings, as tuning can significantly affect system performance. The default values work for most cases.

As a guideline, consider tuning buffers if traffic is very bursty (and coming from several interfaces). In this case:

- Reduce the dedicated buffer on all queues/interfaces.
- Increase the dynamic buffer on all interfaces.
- Increase the cell pointers on a queue that you are expecting will receive the largest number of packets.

Buffer tuning commands

| Task | Command | Command Mode |
|--|----------------------------|----------------|
| Define a buffer profile for the FP queues. | buffer-profile fp fsqueue | CONFIGURATION |
| Define a buffer profile for the CSF queues. | buffer-profile csf csqueue | CONFIGURATION |
| Change the dedicated buffers on a physical 1G interface. | buffer dedicated | BUFFER PROFILE |
| Change the maximum amount of dynamic buffers an interface can request. | buffer dynamic | BUFFER PROFILE |
| Change the number of packet-pointers per queue. | buffer packet-pointers | BUFFER PROFILE |
| Apply the buffer profile to a line card. | buffer fp-uplink linecard | CONFIGURATION |
| Apply the buffer profile to a CSF to FP link. | buffer csf linecard | CONFIGURATION |

FTOS Behavior: If you attempt to apply a buffer profile to a non-existent port-pipe, FTOS displays the following message. However, the configuration still appears in the running-config.

```
%DIFFSERV-2-DSA_BUFF_CARVING_INVALID_PORT_SET: Invalid FP port-set 2 for linecard 2. Valid range of port-set is <0-1>
```

Configuration changes take effect immediately and appear in the running configuration. Since under normal conditions all ports do not require the maximum possible allocation, the configured dynamic allocations can exceed the actual amount of available memory; this is called oversubscription. If you choose to oversubscribe the dynamic allocation, a burst of traffic on one interface might prevent other interfaces from receiving the configured dynamic allocation, which causes packet loss.

You cannot allocate more than the available memory for the dedicated buffers. If the system determines that the sum of the configured dedicated buffers allocated to the queues is more than the total available memory, the configuration is rejected, returning a syslog message similar to the following.

Table 55-6. Buffer Allocation Error

| |
|---|
| <pre>00:04:20: %S50N:0 %DIFFSERV-2-DSA_DEVICE_BUFFER_UNAVAILABLE: Unable to allocate dedicated buffers for stack-unit 0, port pipe 0, egress port 25 due to unavailability of cells</pre> |
|---|

FTOS Behavior: When you remove a buffer-profile using the command `no buffer-profile [fp | csf] from CONFIGURATION mode`, the buffer-profile name still appears in the output of `show buffer-profile [detail | summary]`. After a line card reset, the buffer profile correctly returns to the default values, but the profile name remains. Remove it from the `show buffer-profile [detail | summary]` command output by entering `no buffer [fp-uplink | csf] linecard port-set buffer-policy` from CONFIGURATION mode and `no buffer-policy` from INTERFACE mode.

Display the allocations for any buffer profile using the show commands in [Figure 55-10](#). Display the default buffer profile using the command `show buffer-profile {summary | detail}` from EXEC Privilege mode, as shown in [Figure 55-9](#).

Figure 55-9. Display the Default Buffer Profile

```

FTOS#show buffer-profile detail interface gigabitethernet 0/1
Interface Gi 0/1
Buffer-profile -
Dynamic buffer 194.88 (Kilobytes)
Queue#           Dedicated Buffer      Buffer Packets
                (Kilobytes)
0                 2.50                 256
1                 2.50                 256
2                 2.50                 256
3                 2.50                 256
4                 9.38                 256
5                 9.38                 256
6                 9.38                 256
7                 9.38                 256

```

Figure 55-10. Displaying Buffer Profile Allocations

```

FTOS#show running-config interface tengigabitethernet 2/0 !
interface TenGigabitEthernet 2/0
no ip address
mtu 9252
switchport
no shutdown
buffer-policy myfsbufferprofile

FTOS#show buffer-profile detail int gi 0/10
Interface Gi 0/10
Buffer-profile fsqueue-fp
Dynamic buffer 1256.00 (Kilobytes)
Queue#           Dedicated Buffer      Buffer Packets
                (Kilobytes)
0                 3.00                 256
1                 3.00                 256
2                 3.00                 256
3                 3.00                 256
4                 3.00                 256
5                 3.00                 256
6                 3.00                 256
7                 3.00                 256

FTOS#show buffer-profile detail fp-uplink stack-unit 0 port-set 0
Linecard 0 Port-set 0
Buffer-profile fsqueue-hig
Dynamic Buffer 1256.00 (Kilobytes)
Queue#           Dedicated Buffer      Buffer Packets
                (Kilobytes)
0                 3.00                 256
1                 3.00                 256
2                 3.00                 256
3                 3.00                 256
4                 3.00                 256
5                 3.00                 256
6                 3.00                 256
7                 3.00                 256

```

Using a pre-defined buffer profile

FTOS provides two pre-defined buffer profiles, one for single-queue (i.e non-QoS) applications, and one for four-queue (i.e QoS) applications.

| Task | Command | Mode |
|--|-------------------------------|---------------|
| Apply one of two pre-defined buffer profiles for all port pipes in the system. | buffer-profile global [1Q 4Q] | CONFIGURATION |

You must reload the system for the global buffer profile to take effect ([Message 5](#)).

Message 5 Reload After Applying Global Buffer Profile

```
% Info: For the global pre-defined buffer profile to take effect, please save the config and reload the system.
```

FTOS Behavior: After you configure `buffer-profile global 1Q`, [Message 5](#) is displayed during every bootup. Only one reboot is required for the configuration to take effect; afterwards this bootup message may be ignored.

FTOS Behavior: The buffer profile does not returned to the default, 4Q, if you configure 1Q, save the running-config to the startup-config, and then delete the startup-config and reload the chassis. The only way to return to the default buffer profile is to explicitly configure 4Q, and then reload the chassis.

The `buffer-profile global` command fails if you have already applied a custom buffer profile on an interface.

Message 6 Global Buffer Profile Error

```
% Error: User-defined buffer profile already applied. Failed to apply global pre-defined buffer profile. Please remove all user-defined buffer profiles.
```

Similarly, when `buffer-profile global` is configured, you cannot not apply a buffer profile on any single interface.

Message 7 Global Buffer Profile Error

```
% Error: Global pre-defined buffer profile already applied. Failed to apply user-defined buffer profile on interface Gi 0/1. Please remove global pre-defined buffer profile.
```

If the default buffer profile (4Q) is active, FTOS displays an error message instructing you to remove the default configuration using the command `no buffer-profile global`.

Sample buffer profile configuration

The two general types of network environments are sustained data transfers and voice/data. Dell Force10 recommends a single-queue approach for data transfers, as shown in [Figure 55-11](#).

Figure 55-11. Single Queue Application for S50N with Default Packet Pointers

```

!
buffer-profile fp fsqueue-fp
buffer dedicated queue0 3 queue1 3 queue2 3 queue3 3 queue4 3 queue5 3 queue6 3 queue7 3
buffer dynamic 1256
!
buffer-profile fp fsqueue-hig
buffer dedicated queue0 3 queue1 3 queue2 3 queue3 3 queue4 3 queue5 3 queue6 3 queue7 3
buffer dynamic 1256

!
buffer fp-uplink stack-unit 0 port-set 0 buffer-policy fsqueue-hig
buffer fp-uplink stack-unit 0 port-set 1 buffer-policy fsqueue-hig
!
Interface range gi 0/1 - 48
buffer-policy fsqueue-fp

FTOS#sho run int gi 0/10
!
interface GigabitEthernet 0/10
no ip address

```

Troubleshooting packet loss

The show hardware stack-unit command is intended primarily to troubleshoot packet loss.

- show hardware stack-unit cpu data-plane statistics
- show hardware stack-unit cpu party-bus statistics
- show hardware stack-unit 0-11 drops unit 0-1 port 0-63
- show hardware stack-unit 0-11 stack-port 48-51
- show hardware stack-unit 0-11 unit 0-1 {counters | details | port-stats [detail] | register | execute-shell-cmd | ipmc-replication | table-dump}:
- show hardware {layer2| layer3} {e.g. acl |in acl} stack-unit 0-11 port-set 0-1
- show hardware layer3 qos stack-unit 0-7 port-set 0-1
- show hardware ipv6 {e.g.-acl |in-acl} stack-unit 0-11 port-set 0-1
- show hardware system-flow layer2 stack-unit 0-11 port-set 0-1 [counters]
- clear hardware stack-unit 0-11 counters
- clear hardware stack-unit 0-11 unit 0-1 counters
- clear hardware stack-unit 0-11 cpu data-plane statistics
- clear hardware stack-unit 0-11 cpu party-bus statistics
- clear hardware stack-unit 0-11 stack-port 48-51

Displaying Drop Counters

The show hardware stack-unit 0–11 drops [unit 0 [port 0–63]] command assists in identifying which stack unit, port pipe, and port is experiencing internal drops, as shown in [Figure 55-12](#) and [Figure 55-13](#).

Figure 55-12. Displaying Drop Counter Statistics

```
FTOS#show hardware stack-unit 0 drops
UNIT No: 0
Total Ingress Drops :0
Total IngMac Drops :0
Total Mmu Drops :0
Total EgMac Drops :0
Total Egress Drops :0
UNIT No: 1
Total Ingress Drops :0
Total IngMac Drops :0
Total Mmu Drops :0
Total EgMac Drops :0
Total Egress Drops :0

FTOS#show hardware stack-unit 0 drops unit 0
Port# :Ingress Drops :IngMac Drops :Total Mmu Drops :EgMac Drops :Egress
Drops
1 0 0 0 0 0
2 0 0 0 0 0
3 0 0 0 0 0
4 0 0 0 0 0
5 0 0 0 0 0
6 0 0 0 0 0
7 0 0 0 0 0
8 0 0 0 0 0
```

Display drop counters with the show hardware stack-unit drops unit port command:

Figure 55-13. Displaying Buffer Statistics, Displaying Drop Counters

```

FTOS#show hardware stack-unit 0 drops unit 0 port 1
  --- Ingress Drops      ---
Ingress Drops           : 30
IBP CBP Full Drops     : 0
PortSTPnotFwd Drops    : 0
IPv4 L3 Discards       : 0
Policy Discards        : 0
Packets dropped by FP   : 14
(L2+L3) Drops          : 0
Port bitmap zero Drops : 16
Rx VLAN Drops          : 0

  --- Ingress MAC counters---
Ingress FCSDrops       : 0
Ingress MTUExceeds    : 0

  --- MMU Drops          ---
HOL DROPS              : 0
TxPurge CellErr       : 0
Aged Drops             : 0

  --- Egress MAC counters---
Egress FCS Drops      : 0

  --- Egress FORWARD PROCESSOR Drops ---
IPv4 L3UC Aged & Drops : 0
TTL Threshold Drops   : 0
INVALID VLAN CNTR Drops : 0
L2MC Drops            : 0
PKT Drops of ANY Conditions : 0
Hg MacUnderflow       : 0
TX Err PKT Counter    : 0

```

Dataplane Statistics

The `show hardware stack-unit cpu data-plane statistics` command provides insight into the packet types coming to the CPU. As shown in [Figure 55-14](#), the command output has been augmented, providing detailed RX/TX packet statistics on a per-queue basis. The objective is to see whether CPU-bound traffic is internal (so-called party bus or IPC traffic) or network control traffic, which the CPU must process.

Figure 55-14. Displaying Buffer Statistics, Displaying Dataplane Statistics

```
FTOS#show hardware stack-unit 2 cpu data-plane statistics
```

```
bc pci driver statistics for device:
```

```
rxHandle      :0
noMhdr        :0
noMbuf         :0
noClus         :0
recvd          :0
dropped        :0
recvToNet      :0
rxError        :0
rxDatapathErr :0
rxPkt (COS0)  :0
rxPkt (COS1)  :0
rxPkt (COS2)  :0
rxPkt (COS3)  :0
rxPkt (COS4)  :0
rxPkt (COS5)  :0
rxPkt (COS6)  :0
rxPkt (COS7)  :0
rxPkt (UNIT0) :0
rxPkt (UNIT1) :0
rxPkt (UNIT2) :0
rxPkt (UNIT3) :0
transmitted    :0
txRequested    :0
noTxDesc       :0
txError        :0
txReqTooLarge  :0
txInternalError :0
txDatapathErr  :0
txPkt (COS0)  :0
txPkt (COS1)  :0
txPkt (COS2)  :0
txPkt (COS3)  :0
txPkt (COS4)  :0
txPkt (COS5)  :0
txPkt (COS6)  :0
txPkt (COS7)  :0
txPkt (UNIT0) :0
```

The `show hardware stack-unit cpu party-bus statistics` command displays input and output statistics on the party bus, which carries inter-process communication traffic between CPUs, as shown in [Figure 55-15](#).

Figure 55-15. Displaying Party Bus Statistics

```
FTOS#sh hardware stack-unit 2 cpu party-bus statistics
```

```
Input Statistics:
```

```
27550 packets, 2559298 bytes
0 dropped, 0 errors
```

```
Output Statistics:
```

```
1649566 packets, 1935316203 bytes
0 errors
```

Displaying Stack Port Statistics

The show hardware stack-unit stack-port command displays input and output statistics for a stack-port interface, as shown in [Figure 55-16](#).

Figure 55-16. Displaying Stack Unit Statistics

```
FTOS#show hardware stack-unit 2 stack-port 49
Input Statistics:
  27629 packets, 3411731 bytes
  0 64-byte pkts, 27271 over 64-byte pkts, 207 over 127-byte pkts
  17 over 255-byte pkts, 56 over 511-byte pkts, 78 over 1023-byte pkts
  0 Multicasts, 5 Broadcasts
  0 runts, 0 giants, 0 throttles
  0 CRC, 0 overrun, 0 discarded
Output Statistics:
  1649714 packets, 1948622676 bytes, 0 underruns
  0 64-byte pkts, 27234 over 64-byte pkts, 107970 over 127-byte pkts
  34 over 255-byte pkts, 504838 over 511-byte pkts, 1009638 over 1023-byte pkts
  0 Multicasts, 0 Broadcasts, 1649714 Unicasts
  0 throttles, 0 discarded, 0 collisions
Rate info (interval 45 seconds):
  Input 00.00 Mbits/sec,          2 packets/sec, 0.00% of line-rate
  Output 00.06 Mbits/sec,       8 packets/sec, 0.00% of line-rate
FTOS#
```

Displaying Stack Member Counters

The show hardware stack-unit 0–11 {counters | details | port-stats [detail] | register} command displays internal receive and transmit statistics, based on the selected command option. A sample of the output is shown for the counters option in [Figure 55-17](#).

Figure 55-17. Displaying Stack Unit Counters

| | | | |
|------------|---|---------|----------|
| RIPC4.ge0 | : | 1,202 | +1,202 |
| RUC.ge0 | : | 1,224 | +1,217 |
| RDBG0.ge0 | : | 34 | +24 |
| RDBG1.ge0 | : | 366 | +235 |
| RDBG5.ge0 | : | 16 | +12 |
| RDBG7.ge0 | : | 18 | +12 |
| GR64.ge0 | : | 5,176 | +24 |
| GR127.ge0 | : | 1,566 | +1,433 |
| GR255.ge0 | : | 4 | +4 |
| GRPKT.ge0 | : | 1,602 | +1,461 |
| GRBYT.ge0 | : | 117,600 | +106,202 |
| GRMCA.ge0 | : | 366 | +235 |
| GRBCA.ge0 | : | 12 | +9 |
| GT64.ge0 | : | 4 | +3 |
| GT127.ge0 | : | 964 | +964 |
| GT255.ge0 | : | 4 | +4 |
| GT511.ge0 | : | 1 | +1 |
| GTPKT.ge0 | : | 973 | +972 |
| GTBCA.ge0 | : | 1 | +1 |
| GTBYT.ge0 | : | 71,531 | +71,467 |
| RUC.cpu0 | : | 972 | +971 |
| TDBG6.cpu0 | : | 1,584 | +1,449= |

Application core dumps

Application core dumps are *disabled* by default. A core dump file can be very large. Due to memory requirements the file can only be sent directly to an FTP server. It is not stored on the local flash. Enable full application core dumps with the following:

| Task | Command Syntax | Command Mode |
|--|-------------------------|---------------|
| Enable RPM core dumps and specify the shutdown mode. | logging coredump server | CONFIGURATION |

Undo this command using the no logging coredump server.

Mini core dumps

FTOS supports mini core dumps on the for application and kernel crashes. The mini core dump apply to Master, Standby and Member units.

Application and kernel mini core dumps are always enabled. The mini core dumps contain the stack space and some other very minimal information that can be used to debug a crash. These files are small files and are written into flash until space is exhausted. When the flash is full, the write process is stopped.

A mini core dump contains critical information in the event of a crash. Mini core dump files are located in flash:/ (root dir). The application mini core file name format is f10StkUnit<Stack_unit_no>.<Application name>.acore.mini.txt. The kernel mini core file name format is f10StkUnit<Stack_unit_no>.kcore.mini.txt. Sample files names are shown in [Figure 55-18](#) and sample file text is shown in [Figure 55-19](#).

Figure 55-18. Mini application core file naming example

```
FTOS#dir
Directory of flash:

 1 drw-      16384   Jan 01 1980 00:00:00 +00:00 .
 2 drwx       1536   Sep 03 2009 16:51:02 +00:00 ..
 3 drw-        512   Aug 07 2009 13:05:58 +00:00 TRACE_LOG_DIR
 4 d---        512   Aug 07 2009 13:06:00 +00:00 ADMIN_DIR
 5 -rw-      8693   Sep 03 2009 16:50:56 +00:00 startup-config
 6 -rw-      8693   Sep 03 2009 16:44:22 +00:00 startup-config.bak
 7 -rw-       156   Aug 28 2009 16:16:10 +00:00 f10StkUnit0.mrtm.acore.mini.txt
 8 -rw-       156   Aug 28 2009 17:17:24 +00:00 f10StkUnit0.vrrp.acore.mini.txt
 9 -rw-       156   Aug 28 2009 18:25:18 +00:00 f10StkUnit0.sysd.acore.mini.txt
10 -rw-       156   Aug 28 2009 19:07:36 +00:00 f10StkUnit0.frrp.acore.mini.txt
11 -rw-       156   Aug 31 2009 16:18:50 +00:00 f10StkUnit2.sysd.acore.mini.txt
12 -rw-       156   Aug 29 2009 14:28:34 +00:00 f10StkUnit0.ipml.acore.mini.txt
13 -rw-       156   Aug 31 2009 16:14:56 +00:00 f10StkUnit0.acl.acore.mini.txt

flash: 3104256 bytes total (2959872 bytes free)
FTOS#
```

When a member or standby unit crashes, the mini core file gets uploaded to master unit. When the master unit crashes, the mini core file is uploaded to new master.

Figure 55-19. Mini core text file example

```

                                VALID MAGIC
-----PANIC STRING -----
panic string is :<null>
-----STACK TRACE START-----
0035d60c <f10_save_mmu+0x120>:
00274f8c <panic+0x144>:
0024e2b0 <db_fncall+0x134>:
0024dee8 <db_command+0x258>:
0024d9c4 <db_command_loop+0xc4>:
002522b0 <db_trap+0x158>:
0026a8d0 <mi_switch+0x1b0>:
0026a00c <bpendtsleep>:
-----STACK TRACE END-----

-----FREE MEMORY-----
uvmexp.free = 0x2312

```

The panic string contains key information regarding the crash. Several panic string types exist, and they are displayed in regular English text to enable easier understanding of the crash cause.

TCP dumps

TCP dump captures CPU bound control plane traffic to improve troubleshooting and system manageability. When enabled, a TCP dump captures all the packets on the local CPU, as specified in the CLI.

The traffic capture files can be saved to flash, to FTP, SCP, or TFTP. The files saved on the flash are located in the flash://TCP_DUMP_DIR/Tcpdump_<time_stamp_dir>/ directory, and labeled **tcpdump_*.pcap**. There can be up to 20 Tcpdump_<time_stamp_dir> directories. The file after 20 overwrites the oldest saved file. The maximum file size for a TCP dump capture is 1MB. When a file reaches 1MB, a new file is created, up to the specified total number of files.

Maximize the number of packets recorded in a file by specifying the snap-length to capture the file headers only.

The tcpdump CLI has a finite run process. When the command is enabled, it will run until the capture-duration timer and/or the packet-count counter threshold is met. If no threshold is set, the system uses a default of 5 minute capture-duration and/or a single 1k file as the stopping point for the dump.

The capture-duration timer and the packet-count counter can be used at the same time. The TCP dump stops when the first of the thresholds is met. That means that even if the duration timer is 9000 seconds, if the maximum file count parameter is met first, the dumps stop.

| Task | Command Syntax | Command Mode |
|--|---|---------------|
| Enable a TCP dump for CPU bound traffic. | tcpdump cp [capture-duration <i>time</i> filter <i>expression</i> max-file-count <i>value</i> packet-count <i>value</i> snap-length <i>value</i> write-to <i>path</i>] | CONFIGURATION |

Standards Compliance

This document contains the following sections:

- [IEEE Compliance](#)
- [RFC and I-D Compliance](#)
- [MIB Location](#)



Note: Unless noted, when a standard cited here is listed as supported by FTOS, FTOS also supports predecessor standards. One way to search for predecessor standards is to use the <http://tools.ietf.org/> website. Click on “**Browse and search IETF documents,**” enter an RFC number, and inspect the top of the resulting document for obsolescence citations to related RFCs.

IEEE Compliance

- 802.1AB — LLDP
- 802.1D — Bridging, STP
- 802.1p — L2 Prioritization
- 802.1Q — VLAN Tagging, Double VLAN Tagging, GVRP
- 802.1s — MSTP
- 802.1w — RSTP
- 802.1X — Network Access Control (Port Authentication)
- 802.3ab — Gigabit Ethernet (1000BASE-T)
- 802.3ac — Frame Extensions for VLAN Tagging
- 802.3ad — Link Aggregation with LACP
- 802.3ae — 10 Gigabit Ethernet (10GBASE-W, 10GBASE-X)
- 802.3af — Power over Ethernet
- 802.3ak — 10 Gigabit Ethernet (10GBASE-CX4)
- 802.3i — Ethernet (10BASE-T)
- 802.3u — Fast Ethernet (100BASE-FX, 100BASE-TX)
- 802.3x — Flow Control
- 802.3z — Gigabit Ethernet (1000BASE-X)
- ANSI/TIA-1057— LLDP-MED
- Force10 — FRRP (Force10 Redundant Ring Protocol)
- Force10 — PVST+
- SFF-8431 — SFP+ Direct Attach Cable (10GSFP+Cu)

- MTU — 9,252 bytes

RFC and I-D Compliance

The following standards are supported by FTOS, and are grouped by related protocol. The columns showing support by platform indicate which version of FTOS first supports the standard.



Note: Checkmarks (✓) in the E-Series column indicate that FTOS support was added before FTOS version 7.5.1.

Table 56-1. General Internet Protocols

| RFC# | Full Name | FTOS support, per platform | | | |
|------------------------|---|----------------------------|----------|--------------------|-------------------|
| | | S-Series | C-Series | E-Series TeraScale | E-Series ExaScale |
| 768 | User Datagram Protocol | 7.6.1 | 7.5.1 | ✓ | 8.1.1 |
| 793 | Transmission Control Protocol | 7.6.1 | 7.5.1 | ✓ | 8.1.1 |
| 854 | Telnet Protocol Specification | 7.6.1 | 7.5.1 | ✓ | 8.1.1 |
| 959 | File Transfer Protocol (FTP) | 7.6.1 | 7.5.1 | ✓ | 8.1.1 |
| 1321 | The MD5 Message-Digest Algorithm | 7.6.1 | 7.5.1 | ✓ | 8.1.1 |
| 1350 | The TFTP Protocol (Revision 2) | 7.6.1 | 7.5.1 | ✓ | 8.1.1 |
| 1661 | The Point-to-Point Protocol (PPP) | | | ✓ | |
| 1989 | PPP Link Quality Monitoring | | | ✓ | |
| 1990 | The PPP Multilink Protocol (MP) | | | ✓ | |
| 1994 | PPP Challenge Handshake Authentication Protocol (CHAP) | | | ✓ | |
| 2460 | Internationalization of the File Transfer Protocol | 8.3.12.0 | | | |
| 2474 | Definition of the Differentiated Services Field (DS Field) in the IPv4 and IPv6 Headers | 7.7.1 | 7.5.1 | ✓ | 8.1.1 |
| 2615 | PPP over SONET/SDH | | | ✓ | |
| 2615 | PPP over SONET/SDH | | | ✓ | |
| 2698 | A Two Rate Three Color Marker | | | ✓ | 8.1.1 |
| 3164 | The BSD syslog Protocol | 7.6.1 | 7.5.1 | ✓ | 8.1.1 |
| draft-ietf-bfd-base-03 | Bidirectional Forwarding Detection | | 7.6.1 | ✓ | 8.1.1 |

Table 56-2. General IPv4 Protocols

| | | FTOS support, per platform | | | |
|------|---|----------------------------|----------|--------------------|-------------------|
| RFC# | Full Name | S-Series | C-Series | E-Series TeraScale | E-Series ExaScale |
| 791 | Internet Protocol | 7.6.1 | 7.5.1 | ✓ | 8.1.1 |
| 792 | Internet Control Message Protocol | 7.6.1 | 7.5.1 | ✓ | 8.1.1 |
| 826 | An Ethernet Address Resolution Protocol | 7.6.1 | 7.5.1 | ✓ | 8.1.1 |
| 1027 | Using ARP to Implement Transparent Subnet Gateways | 7.6.1 | 7.5.1 | ✓ | 8.1.1 |
| 1035 | DOMAIN NAMES - IMPLEMENTATION AND SPECIFICATION (client) | 7.6.1 | 7.5.1 | ✓ | 8.1.1 |
| 1042 | A Standard for the Transmission of IP Datagrams over IEEE 802 Networks | 7.6.1 | 7.5.1 | ✓ | 8.1.1 |
| 1191 | Path MTU Discovery | 7.6.1 | 7.5.1 | ✓ | 8.1.1 |
| 1305 | Network Time Protocol (Version 3) Specification, Implementation and Analysis | 7.6.1 | 7.5.1 | ✓ | 8.1.1 |
| 1519 | Classless Inter-Domain Routing (CIDR): an Address Assignment and Aggregation Strategy | 7.6.1 | 7.5.1 | ✓ | 8.1.1 |
| 1542 | Clarifications and Extensions for the Bootstrap Protocol | 7.6.1 | 7.5.1 | ✓ | 8.1.1 |
| 1812 | Requirements for IP Version 4 Routers | 7.6.1 | 7.5.1 | ✓ | 8.1.1 |
| 2131 | Dynamic Host Configuration Protocol | 7.6.1 | 7.5.1 | ✓ | 8.1.1 |
| 2338 | Virtual Router Redundancy Protocol (VRRP) | 7.6.1 | 7.5.1 | ✓ | 8.1.1 |
| 3021 | Using 31-Bit Prefixes on IPv4 Point-to-Point Links | 7.7.1 | 7.7.1 | 7.7.1 | 8.1.1 |
| 3046 | DHCP Relay Agent Information Option | 7.8.1 | 7.8.1 | | |
| 3069 | VLAN Aggregation for Efficient IP Address Allocation | 7.8.1 | 7.8.1 | | |
| 3128 | Protection Against a Variant of the Tiny Fragment Attack | 7.6.1 | 7.5.1 | ✓ | 8.1.1 |

Table 56-3. General IPv6 Protocols

| RFC# | Full Name | FTOS support, per platform | | | |
|----------------|---|----------------------------|----------|--------------------|-------------------|
| | | S-Series | C-Series | E-Series TeraScale | E-Series ExaScale |
| 1886 | DNS Extensions to support IP version 6 | 7.8.1 | 7.8.1 | ✓ | 8.2.1 |
| 1981 (Partial) | Path MTU Discovery for IP version 6 | 7.8.1 | 7.8.1 | ✓ | 8.2.1 |
| 2460 | Internet Protocol, Version 6 (IPv6) Specification | 7.8.1 | 7.8.1 | ✓ | 8.2.1 |
| 2462 (Partial) | IPv6 Stateless Address Autoconfiguration | 7.8.1 | 7.8.1 | ✓ | 8.2.1 |
| 2464 | Transmission of IPv6 Packets over Ethernet Networks | 7.8.1 | 7.8.1 | ✓ | 8.2.1 |
| 2675 | IPv6 Jumbograms | 7.8.1 | 7.8.1 | ✓ | 8.2.1 |
| 2711 | IPv6 Router Alert Option | 8.3.12.0 | | | |
| 3587 | IPv6 Global Unicast Address Format | 7.8.1 | 7.8.1 | ✓ | 8.2.1 |
| 4007 | IPv6 Scoped Address Architecture | 8.3.12.0 | | | |
| 4291 | Internet Protocol Version 6 (IPv6) Addressing Architecture | 7.8.1 | 7.8.1 | ✓ | 8.2.1 |
| 4443 | Internet Control Message Protocol (ICMPv6) for the IPv6 Specification | 7.8.1 | 7.8.1 | ✓ | 8.2.1 |
| 4861 | Neighbor Discovery for IPv6 | 8.3.12.0 | 7.8.1 | ✓ | 8.2.1 |
| 4862 | IPv6 Stateless Address Autoconfiguration | 8.3.12.0 | | | |
| 5175 | IPv6 Router Advertisement Flags Option | 8.3.12.0 | | | |

Table 56-4. Border Gateway Protocol (BGP)

| | | FTOS support, per platform | | | |
|---------------------------|---|----------------------------|----------|--------------------|-------------------|
| RFC# | Full Name | S-Series | C-Series | E-Series TeraScale | E-Series ExaScale |
| 1997 | BGP Communities Attribute | 7.8.1 | 7.7.1 | ✓ | 8.1.1 |
| 2385 | Protection of BGP Sessions via the TCP MD5 Signature Option | 7.8.1 | 7.7.1 | ✓ | 8.1.1 |
| 2439 | BGP Route Flap Damping | 7.8.1 | 7.7.1 | ✓ | 8.1.1 |
| 2545 | Use of BGP-4 Multiprotocol Extensions for IPv6 Inter-Domain Routing | | 7.8.1 | ✓ | 8.2.1 |
| 2796 | BGP Route Reflection: An Alternative to Full Mesh Internal BGP (IBGP) | 7.8.1 | 7.7.1 | ✓ | 8.1.1 |
| 2842 | Capabilities Advertisement with BGP-4 | 7.8.1 | 7.7.1 | ✓ | 8.1.1 |
| 2858 | Multiprotocol Extensions for BGP-4 | 7.8.1 | 7.7.1 | ✓ | 8.1.1 |
| 2918 | Route Refresh Capability for BGP-4 | 7.8.1 | 7.7.1 | ✓ | 8.1.1 |
| 3065 | Autonomous System Confederations for BGP | 7.8.1 | 7.7.1 | ✓ | 8.1.1 |
| 4360 | BGP Extended Communities Attribute | 7.8.1 | 7.7.1 | 7.6.1 | 8.1.1 |
| 4893 | BGP Support for Four-octet AS Number Space | 7.8.1 | 7.7.1 | 7.7.1 | 8.1.1 |
| 5396 | Textual Representation of Autonomous System (AS) Numbers | 8.1.2 | 8.1.2 | 8.1.2 | 8.2.1 |
| draft-ietf-idr-bgp4-20 | A Border Gateway Protocol 4 (BGP-4) | 7.8.1 | 7.7.1 | ✓ | 8.1.1 |
| draft-ietf-idr-restart-06 | Graceful Restart Mechanism for BGP | 7.8.1 | 7.7.1 | ✓ | 8.1.1 |

Table 56-5. Open Shortest Path First (OSPF)

| | | FTOS support, per platform | | | |
|------|---|----------------------------|----------|--------------------|-------------------|
| RFC# | Full Name | S-Series | C-Series | E-Series TeraScale | E-Series ExaScale |
| 1587 | The OSPF Not-So-Stubby Area (NSSA) Option | 7.6.1 | 7.5.1 | ✓ | 8.1.1 |
| 2154 | OSPF with Digital Signatures | 7.6.1 | 7.5.1 | ✓ | 8.1.1 |
| 2328 | OSPF Version 2 | 7.6.1 | 7.5.1 | ✓ | 8.1.1 |
| 2370 | The OSPF Opaque LSA Option | 7.6.1 | 7.5.1 | ✓ | 8.1.1 |
| 2740 | OSPF for IPv6 | | 7.8.1 | ✓ | 8.2.1 |
| 3623 | Graceful OSPF Restart | 7.8.1 | 7.5.1 | ✓ | 8.1.1 |
| 4222 | Prioritized Treatment of Specific OSPF Version 2 Packets and Congestion Avoidance | 7.6.1 | 7.5.1 | ✓ | 8.1.1 |

Table 56-6. Intermediate System to Intermediate System (IS-IS)

| | | FTOS support, per platform | | | |
|-------------------------------------|--|----------------------------|----------|--------------------|-------------------|
| RFC# | Full Name | S-Series | C-Series | E-Series TeraScale | E-Series ExaScale |
| 1142 | OSI IS-IS Intra-Domain Routing Protocol (ISO DP 10589) | | | ✓ | 8.1.1 |
| 1195 | Use of OSI IS-IS for Routing in TCP/IP and Dual Environments | | | ✓ | 8.1.1 |
| 2763 | Dynamic Hostname Exchange Mechanism for IS-IS | | | ✓ | 8.1.1 |
| 2966 | Domain-wide Prefix Distribution with Two-Level IS-IS | | | ✓ | 8.1.1 |
| 3373 | Three-Way Handshake for Intermediate System to Intermediate System (IS-IS) Point-to-Point Adjacencies | | | ✓ | 8.1.1 |
| 3567 | IS-IS Cryptographic Authentication | | | ✓ | 8.1.1 |
| 3784 | Intermediate System to Intermediate System (IS-IS) Extensions in Support of Generalized Multi-Protocol Label Switching (GMPLS) | | | ✓ | 8.1.1 |
| 5120 | MT-ISIS: Multi Topology (MT) Routing in Intermediate System to Intermediate Systems (IS-ISs) | | | 7.8.1 | 8.2.1 |
| 5306 | Restart Signaling for IS-IS | | | 8.3.1 | 8.3.1 |
| 5308 | Routing IPv6 with IS-IS | 8.3.10.0 | | 7.5.1 | 8.2.1 |
| draft-ietf-isis-igp-p2p-over-lan-06 | Point-to-point operation over LAN in link-state routing protocols | | | ✓ | 8.1.1 |
| draft-kaplan-isis-ext-eth-02 | Extended Ethernet Frame Size Support | | | ✓ | 8.1.1 |

Table 56-7. Routing Information Protocol (RIP)

| | | FTOS support, per platform | | | |
|------|---|----------------------------|----------|--------------------|-------------------|
| RFC# | Full Name | S-Series | C-Series | E-Series TeraScale | E-Series ExaScale |
| 1058 | Routing Information Protocol | 7.8.1 | 7.6.1 | ✓ | 8.1.1 |
| 2453 | RIP Version 2 | 7.8.1 | 7.6.1 | ✓ | 8.1.1 |
| 4191 | Default Router Preferences and More-Specific Routes | 8.3.12.0 | | | |

Table 56-8. Multiprotocol Label Switching (MPLS)

| | | FTOS support, per platform | | | |
|------|---|----------------------------|----------|--------------------|-------------------|
| RFC# | Full Name | S-Series | C-Series | E-Series TeraScale | E-Series ExaScale |
| 2702 | Requirements for Traffic Engineering Over MPLS | | | | 8.3.1 |
| 3031 | Multiprotocol Label Switching Architecture | | | | 8.3.1 |
| 3032 | MPLS Label Stack Encoding | | | | 8.3.1 |
| 3209 | RSVP-TE: Extensions to RSVP for LSP Tunnels | | | | 8.3.1 |
| 3630 | Traffic Engineering (TE) Extensions to OSPF Version 2 | | | | 8.3.1 |
| 3784 | Intermediate System to Intermediate System (IS-IS) Extensions for Traffic Engineering (TE) | | | | 8.3.1 |
| 3812 | Multiprotocol Label Switching (MPLS) Traffic Engineering (TE) Management Information Base (MIB) | | | | 8.3.1 |
| 3813 | Multiprotocol Label Switching (MPLS) Label Switching Router (LSR) Management Information Base (MIB) | | | | 8.3.1 |
| 4090 | Fast Reroute Extensions to RSVP-TE for LSP Tunnels | | | | 8.3.1 |
| 4379 | Detecting Multi-Protocol Label Switched Data Plane Failures (MPLS TE/LDP Ping & Traceroute) | | | | 8.3.1 |
| 5036 | LDP Specification | | | | 8.3.1 |
| 5063 | Extensions to GMPLS Resource Reservation Protocol (RSVP) Graceful Restart | | | | 8.3.1 |

Table 56-9. Multicast

| | | FTOS support, per platform | | | |
|-----------------------------|---|-----------------------------|-----------------------|---|--|
| RFC# | Full Name | S-Series | C-Series | E-Series TeraScale | E-Series ExaScale |
| 1112 | Host Extensions for IP Multicasting | 7.8.1 | 7.7.1 | ✓ | 8.1.1 |
| 2236 | Internet Group Management Protocol, Version 2 | 7.8.1 | 7.7.1 | ✓ | 8.1.1 |
| 2710 | Multicast Listener Discovery (MLD) for IPv6 | | | ✓ | 8.2.1 |
| 3376 | Internet Group Management Protocol, Version 3 | 7.8.1 | 7.7.1 | ✓ | 8.1.1 |
| 3569 | An Overview of Source-Specific Multicast (SSM) | 7.8.1 SSM for IPv4 | 7.7.1 SSM for IPv4 | 7.5.1 SSM for IPv4/ IPv6 | 8.2.1 SSM for IPv4 |
| 3618 | Multicast Source Discovery Protocol (MSDP) | | | ✓ | 8.1.1 |
| 3810 | Multicast Listener Discovery Version 2 (MLDv2) for IPv6 | | | ✓ | 8.2.1 |
| 3973 | Protocol Independent Multicast - Dense Mode (PIM-DM): Protocol Specification (Revised) | | | ✓ | |
| 4541 | Considerations for Internet Group Management Protocol (IGMP) and Multicast Listener Discovery (MLD) Snooping Switches | 7.6.1 (IGMPv1/v2) | 7.6.1 (IGMPv1/v2) | ✓ IGMPv1/v2/v3, MLDv1 Snooping | 8.2.1 IGMPv1/v2/ v3, MLDv1 Snooping |
| draft-ietf-pim-sm-v2-new-05 | Protocol Independent Multicast - Sparse Mode (PIM-SM): Protocol Specification (Revised) | 7.8.1 PIM-SM for IPv4 | 7.7.1 | ✓ IPv4/ IPv6 | 8.2.1 PIM-SM for IPv4/IPv6 |

Table 56-10. Network Management

| | | FTOS support, per platform | | | |
|------|---|----------------------------|----------|--------------------|-------------------|
| RFC# | Full Name | S-Series | C-Series | E-Series TeraScale | E-Series ExaScale |
| 1155 | Structure and Identification of Management Information for TCP/IP-based Internets | 7.6.1 | 7.5.1 | ✓ | 8.1.1 |
| 1156 | Management Information Base for Network Management of TCP/IP-based internets | 7.6.1 | 7.5.1 | ✓ | 8.1.1 |
| 1157 | A Simple Network Management Protocol (SNMP) | 7.6.1 | 7.5.1 | ✓ | 8.1.1 |
| 1212 | Concise MIB Definitions | 7.6.1 | 7.5.1 | ✓ | 8.1.1 |
| 1215 | A Convention for Defining Traps for use with the SNMP | 7.6.1 | 7.5.1 | ✓ | 8.1.1 |
| 1493 | Definitions of Managed Objects for Bridges [except for the dot1dTpLearnedEntryDiscards object] | 7.6.1 | 7.5.1 | ✓ | 8.1.1 |
| 1724 | RIP Version 2 MIB Extension | | 7.5.1 | ✓ | 8.1.1 |
| 1850 | OSPF Version 2 Management Information Base | 7.6.1 | 7.5.1 | ✓ | 8.1.1 |
| 1901 | Introduction to Community-based SNMPv2 | 7.6.1 | 7.5.1 | ✓ | 8.1.1 |
| 2011 | SNMPv2 Management Information Base for the Internet Protocol using SMIPv2 | 7.6.1 | 7.5.1 | ✓ | 8.1.1 |
| 2012 | SNMPv2 Management Information Base for the Transmission Control Protocol using SMIPv2 | 7.6.1 | 7.5.1 | ✓ | 8.1.1 |
| 2013 | SNMPv2 Management Information Base for the User Datagram Protocol using SMIPv2 | 7.6.1 | 7.5.1 | ✓ | 8.1.1 |
| 2024 | Definitions of Managed Objects for Data Link Switching using SMIPv2 | 7.6.1 | 7.5.1 | ✓ | 8.1.1 |
| 2096 | IP Forwarding Table MIB | 7.6.1 | 7.5.1 | ✓ | 8.1.1 |
| 2558 | Definitions of Managed Objects for the Synchronous Optical Network/Synchronous Digital Hierarchy (SONET/SDH) Interface Type | | | ✓ | |
| 2570 | Introduction and Applicability Statements for Internet Standard Management Framework | 7.6.1 | 7.5.1 | ✓ | 8.1.1 |
| 2571 | An Architecture for Describing Simple Network Management Protocol (SNMP) Management Frameworks | 7.6.1 | 7.5.1 | ✓ | 8.1.1 |
| 2572 | Message Processing and Dispatching for the Simple Network Management Protocol (SNMP) | 7.6.1 | 7.5.1 | ✓ | 8.1.1 |
| 2574 | User-based Security Model (USM) for version 3 of the Simple Network Management Protocol (SNMPv3) | 7.6.1 | 7.5.1 | ✓ | 8.1.1 |
| 2575 | View-based Access Control Model (VACM) for the Simple Network Management Protocol (SNMP) | 7.6.1 | 7.5.1 | ✓ | 8.1.1 |

Table 56-10. Network Management (continued)

| | | FTOS support, per platform | | | |
|------|---|----------------------------|----------|--------------------|-------------------|
| RFC# | Full Name | S-Series | C-Series | E-Series TeraScale | E-Series ExaScale |
| 2576 | Coexistence Between Version 1, Version 2, and Version 3 of the Internet-standard Network Management Framework | 7.6.1 | 7.5.1 | ✓ | 8.1.1 |
| 2578 | Structure of Management Information Version 2 (SMIv2) | 7.6.1 | 7.5.1 | ✓ | 8.1.1 |
| 2579 | Textual Conventions for SMIv2 | 7.6.1 | 7.5.1 | ✓ | 8.1.1 |
| 2580 | Conformance Statements for SMIv2 | 7.6.1 | 7.5.1 | ✓ | 8.1.1 |
| 2618 | RADIUS Authentication Client MIB, except the following four counters: radiusAuthClientInvalidServerAddresses radiusAuthClientMalformedAccessResponses radiusAuthClientUnknownTypes radiusAuthClientPacketsDropped | 7.6.1 | 7.5.1 | ✓ | 8.1.1 |
| 2665 | Definitions of Managed Objects for the Ethernet-like Interface Types | 7.6.1 | 7.5.1 | ✓ | 8.1.1 |
| 2674 | Definitions of Managed Objects for Bridges with Traffic Classes, Multicast Filtering and Virtual LAN Extensions | 7.6.1 | 7.5.1 | ✓ | 8.1.1 |
| 2787 | Definitions of Managed Objects for the Virtual Router Redundancy Protocol | 7.6.1 | 7.5.1 | ✓ | 8.1.1 |
| 2819 | Remote Network Monitoring Management Information Base: Ethernet Statistics Table, Ethernet History Control Table, Ethernet History Table, Alarm Table, Event Table, Log Table | 7.6.1 | 7.5.1 | ✓ | 8.1.1 |
| 2863 | The Interfaces Group MIB | 7.6.1 | 7.5.1 | ✓ | 8.1.1 |
| 2865 | Remote Authentication Dial In User Service (RADIUS) | 7.6.1 | 7.5.1 | ✓ | 8.1.1 |
| 3273 | Remote Network Monitoring Management Information Base for High Capacity Networks (64 bits): Ethernet Statistics High-Capacity Table, Ethernet History High-Capacity Table | 7.6.1 | 7.5.1 | ✓ | 8.1.1 |
| 3416 | Version 2 of the Protocol Operations for the Simple Network Management Protocol (SNMP) | 7.6.1 | 7.5.1 | ✓ | 8.1.1 |
| 3418 | Management Information Base (MIB) for the Simple Network Management Protocol (SNMP) | 7.6.1 | 7.5.1 | ✓ | 8.1.1 |
| 3434 | Remote Monitoring MIB Extensions for High Capacity Alarms, High-Capacity Alarm Table (64 bits) | 7.6.1 | 7.5.1 | ✓ | 8.1.1 |
| 3580 | IEEE 802.1X Remote Authentication Dial In User Service (RADIUS) Usage Guidelines | 7.6.1 | 7.5.1 | ✓ | 8.1.1 |

Table 56-10. Network Management (continued)

| | | FTOS support, per platform | | | |
|----------------------------|---|----------------------------|----------|--------------------|-------------------|
| RFC# | Full Name | S-Series | C-Series | E-Series TeraScale | E-Series ExaScale |
| 3815 | Definitions of Managed Objects for the Multiprotocol Label Switching (MPLS), Label Distribution Protocol (LDP) | | | | 8.3.1 |
| 4001 | Textual Conventions for Internet Network Addresses | 8.3.12 | | | |
| 5060 | Protocol Independent Multicast MIB | 7.8.1 | 7.8.1 | 7.7.1 | 8.1.1 |
| ANSI/TIA-1057 | The LLDP Management Information Base extension module for TIA-TR41.4 Media Endpoint Discovery information | 7.7.1 | 7.6.1 | 7.6.1 | 8.1.1 |
| draft-grant-tacacs-02 | The TACACS+ Protocol | 7.6.1 | 7.5.1 | ✓ | 8.1.1 |
| draft-ietf-idr-bgp4-mib-06 | Definitions of Managed Objects for the Fourth Version of the Border Gateway Protocol (BGP-4) using SMIV2 | 7.8.1 | 7.7.1 | ✓ | 8.1.1 |
| draft-ietf-isis-wg-mib-16 | Management Information Base for Intermediate System to Intermediate System (IS-IS): isisSysObject (top level scalar objects) isisSAdjTable isisSAdjAreaAddrTable isisSAdjIPAddrTable isisSAdjProtSuppTable | | | ✓ | 8.1.1 |
| IEEE 802.1AB | Management Information Base module for LLDP configuration, statistics, local system data and remote systems data components. | 7.7.1 | 7.6.1 | 7.6.1 | 8.1.1 |
| IEEE 802.1AB | The LLDP Management Information Base extension module for IEEE 802.1 organizationally defined discovery information. (LLDP DOT1 MIB and LLDP DOT3 MIB) | 7.7.1 | 7.6.1 | 7.6.1 | 8.1.1 |
| IEEE 802.1AB | The LLDP Management Information Base extension module for IEEE 802.3 organizationally defined discovery information. (LLDP DOT1 MIB and LLDP DOT3 MIB) | 7.7.1 | 7.6.1 | 7.6.1 | 8.1.1 |
| ruzin-mstp-mib-02 (Traps) | Definitions of Managed Objects for Bridges with Multiple Spanning Tree Protocol | 7.6.1 | 7.6.1 | 7.6.1 | 8.1.1 |
| sFlow.org | sFlow Version 5 | 7.7.1 | 7.6.1 | ✓ | 8.1.1 |
| sFlow.org | sFlow Version 5 MIB | 7.7.1 | 7.6.1 | ✓ | 8.1.1 |
| FORCE10-BGP4-V2-MIB | Force10 BGP MIB (draft-ietf-idr-bgp4-mibv2-05) | 7.8.1 | 7.7.1 | ✓ | 8.1.1 |
| FORCE10-FIB-MIB | Force10 CIDR Multipath Routes MIB (The IP Forwarding Table provides information that you can use to determine the egress port of an IP packet and troubleshoot an IP reachability issue. It reports the autonomous system of the next hop, multiple next hop support, and policy routing support) | | | 7.6.1 | 8.1.1 |

Table 56-10. Network Management (continued)

| | | FTOS support, per platform | | | |
|------------------------------|--|----------------------------|----------|--------------------|-------------------|
| RFC# | Full Name | S-Series | C-Series | E-Series TeraScale | E-Series ExaScale |
| FORCE10-CS-C HASSIS-MIB | Force10 C-Series Enterprise Chassis MIB | | 7.5.1 | | |
| FORCE10-IF-EXTENSION-MIB | Force10 Enterprise IF Extension MIB (extends the Interfaces portion of the MIB-2 (RFC 1213) by providing proprietary SNMP OIDs for other counters displayed in the "show interfaces" output) | 7.6.1 | 7.6.1 | 7.6.1 | 8.1.1 |
| FORCE10-LINK AGG-MIB | Force10 Enterprise Link Aggregation MIB | 7.6.1 | 7.5.1 | ✓ | 8.1.1 |
| FORCE10-CHASSIS-MIB | Force10 E-Series Enterprise Chassis MIB | | | ✓ | 8.1.1 |
| FORCE10-COPY-CONFIG-MIB | Force10 File Copy MIB (supporting SNMP SET operation) | 7.7.1 | 7.7.1 | ✓ | 8.1.1 |
| FORCE10-MON-MIB | Force10 Monitoring MIB | 7.6.1 | 7.5.1 | ✓ | 8.1.1 |
| FORCE10-PRODUCTS-MIB | Force10 Product Object Identifier MIB | 7.6.1 | 7.5.1 | ✓ | 8.1.1 |
| FORCE10-SS-C HASSIS-MIB | Force10 S-Series Enterprise Chassis MIB | 7.6.1 | | | |
| FORCE10-SMI | Force10 Structure of Management Information | 7.6.1 | 7.5.1 | ✓ | 8.1.1 |
| FORCE10-SYSTEM-COMPONENT-MIB | Force10 System Component MIB (enables the user to view CAM usage information) | 7.6.1 | 7.5.1 | ✓ | 8.1.1 |
| FORCE10-TC-MIB | Force10 Textual Convention | 7.6.1 | 7.5.1 | ✓ | 8.1.1 |
| FORCE10-TRAP-ALARM-MIB | Force10 Trap Alarm MIB | 7.6.1 | 7.5.1 | ✓ | 8.1.1 |

MIB Location

Force10 MIBs can be found under the **Force10 MIBs** subhead on the **Documentation** page of iSupport:

<https://www.force10networks.com/csportal20/KnowledgeBase/Documentation.aspx>

You also can obtain a list of selected MIBs and their OIDs at the following URL:

https://www.force10networks.com/csportal20/MIBs/MIB_OIDs.aspx

Some pages of iSupport require a login. To request an iSupport account, go to:

<https://www.force10networks.com/CSPortal20/Support/AccountRequest.aspx>

If you have forgotten or lost your account information, contact Dell Force10 TAC for assistance.

Index

Numerics

- 10/100/1000 Base-T Ethernet line card, auto negotiation 474
- 100/1000 Ethernet interfaces
 - port channels 448
- 4-Byte AS Numbers 192
- 802.1AB 1091
- 802.1D 1091
- 802.1p 1091
- 802.1p/Q 1091
- 802.1Q 1091
- 802.1s 1091
- 802.1w 1091
- 802.1X 1091
- 802.3ab 1091
- 802.3ac 1091
- 802.3ad 1091
- 802.3ae 1091
- 802.3af 1091
- 802.3ak 1091
- 802.3i 1091
- 802.3u 1091
- 802.3x 1091
- 802.3z 1091

A

- AAA (Accounting, Authentication, and Authorization)
 - security model 817
- AAA Accounting 817
 - command 818
 - suppress null-username command 818
- AAA Authentication
 - authentication and authorization, local by default 823
 - command 822
 - configuring 821
 - enable 822
 - enable command 822
 - enable method 821
 - line method 821
 - local method 821
 - none method 821
 - radius method 821
 - tacacs+ 821
- AAA Authorization
 - AAA new-model enabled by default 823
- ABR
 - definition 704
- Access 48
- Access the C-Series, E-Series, S4810, and the S4820T
 - Remotely 48

- access-class 836
- ACL
 - definition 109
 - IP ACL definition 109
 - RADIUS 829
- ANSI/TIA-1057 611
- Applying an ACL to Loopback 127
- Area Border Router. *See* ABR.
- AS 180
 - support 200
- AS-PATH ACL
 - "permit all routes" statement 229
 - configuring 216
- AS_PATH attribute
 - using 215
- Authentication
 - implementation 820
 - TACACS+ 835
 - VTY 850
- Authorization
 - TACACS+ 835
 - VTY 850
- auto negotiation 474
- auto negotiation, line card 474
- Auto-command 830

B

- Balancing, load 455
- Bare Metal Provisioning 253
 - BMP prerequisites 253
 - DHCP server requirement 255
 - restrictions 254
- Base VLAN 736
- BGP 180
 - Attributes 185
 - Autonomous Systems 180
 - best path criteria 185
 - changing COMMUNITY numbers in a path 223
 - changing how MED attribute is used 224
 - changing LOCAL_PREF default value 225
 - changing the LOCAL_PREF default values for routes on a router 225
 - clearing route dampening information 234
 - Communities 184
 - configuring a route reflector 230
 - configuring an AS-PATH ACL 216
 - configuring an IP community list 220
 - configuring BGP confederations 232
 - configuring BGP timers 235
 - configuring route flap dampening 233

- configuring the router as next hop 225
- creating a peer group 206, 207
- default 199, 222
- Distance defaults 199
- enabling a peer group 208
- establishing BGP process 201
- External BGP requirements 200
- Fast External Fallover 199
- filtering routes based on AS-PATH 229
- filtering routes using a route map 228
- filtering routes using IP Community list 221
- filtering routes using prefix lists 227
- graceful restart tasks 214
- graceful restart, default role 214
- graceful restart, default setting 199
- graceful restart, enabling 214
- graceful restart, hot failover actions 214
- graceful restart, implementing by neighbor or BGP peer-group 215
- Implementing with FTOS 191
- inbound and outbound policies 227
- Internal BGP requirements 200
- KEEPALIVE messages 200
- LOCAL_PREF default value 199
- MULTI_EXIT_DISC default value 199
- Neighbor Adjacency changes 199
- neighbors 200
- resetting a BGP neighbor 235
- route dampening information 232
- Route Flap Damping Parameters 199
- Route Reflectors 183
- route reflectors 230
- sending the COMMUNITY attribute 222
- Sessions and Peers 182
- specifying next hop address 226
- Timers defaults 199
- timers negotiation 236
- viewing all BGP path attributes 215
- viewing the BGP configuration 202
- viewing the status of BGP neighbors 203
- viewing the status of peer groups 208
- Border Gateway Protocol (BGP) 179
- BPDU 811
- Bridge MIB
 - STP implementation 946
- Bridge Protocol Data Units. *See* *BPDU*.

C

- CAM Profiling, When to Use 267
- cam-acl 560

- cam-profile 558
- CLI
 - case sensitivity 40
 - editing commands 40
 - partial keywords 40
- CLI Modes
 - LINE 34
- COMMUNITY attribute
 - changing in a path 223
 - default 222
 - NO_ADVERTISE 220, 223
 - NO_EXPORT 220, 223
 - NO_EXPORT_SUBCONFED 220, 223
- Community list
 - configuring 220
- community port 736
- community VLAN 735
- Console terminal line 71
- Control Plane Policing (CoPP) 281
- coredumps 1087
- crypto key generate 839
- C-Series and S-Series load-balancing 457
- CSNP 518

D

- debug ip ssh 839
- Default VLAN
 - changing the VLAN id 996
 - implementation 996
 - Layer 2 mode 996
 - remove interface 1001
 - remove untagged interface 997
 - untagged interfaces 996, 999
- DHCP server, used in BMP 255
- directed broadcast 488
- disable-on-sfm failure 466
- display parameter 44
- distribution algorithms 454
- DNS 489
- Document conventions 29
- dynamic hostname exchange 517

E

- ECMP
 - link bundle monitoring 363
- extended IP ACL 110

F

- Fast Convergence after MSTP-Triggered Topology Changes 434

- fast-convergence
 - OSPF 707
- File Transfer Protocol. *See* FTP.
- flowcontrol 471
- Force 10 Resilient Ring Protocol 385
- forward delay 812, 951
- FRRP 385
- FRRP Master Node 385
- FRRP Transit Node 386
- FTOS 694
- FTP 69
 - configuring client parameters 70
 - configuring server parameters 70
 - enabling server 69
 - using VLANs 69

G

- GARP VLAN Registration Protocol (GVRP) 397
- grep option 41
- grep pipe option 742
- GVRP (GARP VLAN Registration Protocol) 397

H

- Hash algorithm 457
- hash algorithm, LAG 450, 452, 454
- hashing algorithms for flows and fragments 454
- hello time 812, 951
- host port 736
- Hot Lock ACL 110
- Hybrid ports 1000
- hybrid ports 1003

I

- I-D (Internet Draft) Compliance 1092
- Idle Time 829
- IEEE 802.1q 397
- IEEE 802.1Q tag 997
- IEEE Compliance 1091
- IEEE Standard 802.3ad 447
- IGMP
 - viewing which interfaces are IGMP-enabled 429
- implicit deny 109
- Interface modes
 - Layer 2 439
 - Layer 3 439
- Interface Range Macros 461
- Interface types
 - 100/1000 Ethernet 440
 - 10-Gigabit Ethernet 440
 - 1-Gigabit Ethernet 440
 - Ethernet 435
 - Loopback 440
 - management 440
 - Management Ethernet interface 439
 - Port Channel 440
 - SONET 435
 - VLAN 440
- interface types
 - null interface 440
- interfaces
 - auto negotiation setting 474
 - clearing counters 481
 - commands allowed when part of a port channel 450
 - configuring secondary IP addresses 485
 - determining configuration 441
 - member of port channel 452
 - viewing Layer 3 interfaces 437
 - viewing only Layer 2 interfaces 477
- Inter-VLAN routing 445
 - considerations 445
- IP ACLs
 - applying ACL for loopback 127
 - applying IP ACL to interface 123
 - configuring extended IP ACL 119
 - configuring extended IP ACL for TCP 119
 - configuring extended IP ACL for UDP 120
 - configuring filter without sequence number 121
 - configuring standard IP ACL 116, 117
 - deleting a filter 117, 118
 - extended IP ACLs 110, 118
 - standard IP ACL 110
 - types 110
 - viewing configuration 117
- IP addresses
 - assigning IP address to interface 441
 - assigning to interface 485
 - assigning to port channel 454
 - assigning to VLAN 1002
 - composition 483
 - configuring static routes 486
- IP fragmentation 469
- IP hashing scheme 457
- ip local-proxy-arp command 742
- IP MTU
 - configuring 472
 - maximum size 469
- IP prefix lists
 - "permit all" statement 130
 - applying to OSPF routes 132
 - applying to RIP routes 132

- configuring filter 129
- configuring filters without seq command 130
- definition 128
- deleting filter 130, 131
- implementation 129
- permit default route only 130
- rules 129, 228
- using the le and ge parameters 128
- IP routing
 - VLANs 997
- ip scp topdir 839
- ip ssh authentication-retries 839
- ip ssh connection-rate-limit 839
- ip ssh hostbased-authentication enable 840
- ip ssh password-authentication enable 840
- ip ssh pub-key-file 840
- ip ssh rhostsfile 840
- ip ssh rsa-authentication 840
- ip ssh rsa-authentication enable 840
- ip ssh server command 838
- IP traffic load balancing 457
- IP version 4 483
- IS-IS
 - area address 514
 - defaults 518
 - dynamic hostname exchange 517
 - Intermediate System to Intermediate System 513
 - Level 1 513
 - Level 1-2 513
 - Level 2 513
 - NET 514
 - N-selector 514
 - system address 514
- ISIS
 - graceful-restart 523
 - redistribute OSPF 218, 533, 534
- IS-IS TLVs 517
- ISO/IEC 10589 515
- isolated port 736
- Isolated VLAN 736

J

- Jumpstart mode
 - default in BMP 2.0 254

L

- LAG hash algorithm 450, 452, 454
- LAG. See Port Channels.
- Layer 2 mode
 - configuring 440

- Layer 2 protocols
 - configuring 440
- Layer 3 mode
 - enable traffic 441
- Layer 3 protocols
 - configuring 441
- Level 1
 - definition 513
 - using NET 514
- Level 1-2
 - definition 513
- Level 2
 - definition 513
 - using NET 514
- line card, auto negotiation 474
- Link Aggregation Group 447
- link debounce interface 466
- Link Debounce Timer 466, 470
- Link Layer Discovery Protocol (LLDP) 607
- link MTU
 - configuring 472
 - maximum size 469
- Link State Advertisements. *See LSAs.*
- Link State PDUs. *See LSPs.*
- LLDP 607
- LLDP-MED 611
- load balancing 454
- load-balance
 - command combinations 456
 - criteria 454
 - hash algorithm 454
- LOCAL_PREF attribute
 - changing default value 225
 - changing value for a router 225
- logging
 - changing settings 65
 - consolidating messages 68
 - including timestamp 68
 - UNIX system logging facility 66
- Loopback interface
 - configuring 446
 - defaults 440
 - definition 446
 - deleting interface 446
 - viewing configuration 446
- Loopback, Configuring ACLs to 127
- LSAs 687
 - AS Boundary 694
 - AS External 694
 - Network 694
 - Network Summary 694

- NSSA External 695
- Opaque Area-local 694
- Opaque Link-local 695
- Router 694
- types supported 694
- LSPs 514

M

- MAC hashing scheme 457
- management interface 440
 - accessing 443
 - configuring a management interface 443
 - configuring IP address 443
 - definition 442
 - IP address consideration 443
- management interface, switch 439
- max age 812, 951
- MBGP 238
- Member VLAN (FRRP) 387
- MIB Location 1103
- minimum oper up links in a port channel 453
- mirror, port 727, 981
 - remote port mirroring 982
- monitor interfaces 462
- MSDP 631
- MT IS-IS 515
- MT IS-IS TLVs 517
- MTU
 - configuring MTU values for Port Channels 472
 - configuring MTU values for VLANs 473
 - definition 469
 - IP MTU
 - configuring 472
 - maximum size 469
 - link MTU
 - configuring 472
 - maximum size 469
- MTU Size, Configuring on an Interface 472
- MULTI_EXIT_DISC attribute
 - changing 224
 - default value 199
- Multi-Topology IS-IS 515

N

- NET 514
 - area address 514
 - length 514
 - N-selector 514
 - system address 514
- Network Entity Title. *See* NET.

- NIC teaming 594
- no-more 44
- no-more parameter 44
- NSAP addresses 514
- NTP
 - configuring authentication 970
 - configuring source address 970
- null 440
- null interface
 - available command 446
 - definition 446
 - entering the interface 446
 - information 440

O

- Open Shortest Path First 687
- OSFP Adjacency with Cisco Routers 697
- OSPF 687
 - backbone area 701
 - changing authentication parameters 710
 - changing interface parameters 709
 - configuring a passive interface 706
 - configuring a stub area 704
 - configuring network command 701
 - configuring virtual links 711
 - debugging OSPF 715
 - default 698
 - disabling OSPF 700, 701
 - enabling routing 699
 - LSA throttling 693
 - redistributing routes 712, 713
 - restarting OSPF 700, 701
 - router ID 702
 - using loopback interfaces 703
 - using prefix lists 712
 - viewing configuration of neighboring router 715
 - viewing interface areas 702
 - viewing virtual link configuration 711
- Output of show interfaces switchport 858

P

- packet-based hashing 454
- passwords
 - configuring password 824
- PDU 514
- port channel
 - definition 447
- port channel (LAG), configure 449
- port channel, minimum oper up links 453
- Port Channels

- configuring MTU values 472
- member of VLANs 998
- Port channels
 - benefits 447
 - defaults 440
- port channels
 - adding physical interface 450
 - assigning IP address 454
 - commands allowed on individual interfaces 450
 - configuring 449
 - containing 100/1000 and GE interfaces 448
 - IP routing 454
 - placing in Layer 2 mode 449
 - reassigning interfaces 452
- port cost 812, 951
- port mirror 727, 981
 - remote 982
- Port Monitoring Commands
 - Important Points to Remember 727
- port priority 812, 951
- port types (private VLAN) 736
- port-based VLANs 997
 - assigning IP address 1002
 - benefits 997
 - creating VLAN 998
 - definition 997
 - deleting VLAN 999
 - enabling tagging 1000
 - interface requirements 997
 - IP routing 997
 - number supported 997
 - remove interface 1001
 - remove tagged interface 1000
 - tag frames 1000
 - tagged interface
 - member of multiple VLANs 1000
- Portfast 813, 952
- PPP 439
- Prefix list. *See IP Prefix list.*
- Primary VLAN 736
- Private VLAN (PVLAN) 735
- private-vlan mapping secondary-vlan command 737
- Privilege Level 830
- privilege levels
 - and CLI commands 824
 - definition 823
 - number of levels available 823
 - privilege level 0 definition 823
 - privilege level 1 definition 823
 - privilege level 15 definition 823

- promiscuous port 736
- Protocol Data Units. *See PDU.*
- Proxy ARP
 - default 492

Q

- QoS
 - dot1p queue numbers 760
 - dot1p-priority values 760
 - purpose of input policies 768
 - rate limit outgoing traffic 763
- QoS (Quality of Service) chapter 757
- QSFP port splitting 464
- Quality of Service (QoS) chapter 757

R

- RADIUS
 - changing an optional parameter 832
 - configuration requirements 828
 - configuring global communication parameter 832
 - debugging RADIUS transactions 833, 835
 - definition 828
 - deleting a server host 832
 - specifying a server host 831, 836
 - viewing RADIUS configuration 833
- RADIUS authentication 823
- RADIUS Authentication and Authorization 829
- radius-server host command 822
- rate-interval command 478
- redistribute
 - ROUTER ISIS 218, 533, 534
- remote port mirroring 982
- RFC 1058 783
- RFC 1493 946
- RFC 1858 837
- RFC 2138 828
- RFC 2338 1044
- RFC 2453 783
- RFC 3128 837
- RFC 791 483, 484
- RFC 959 69
- RFC Compliance 1092
- RIP
 - adding routes 787
 - auto summarization default 784
 - changing RIP version 788
 - configuring interfaces to run RIP 786
 - debugging RIP 792
 - default values 784
 - default version 785

- disabling RIP 786
- ECMP paths supported 784
- enabling RIP 785
- route information 787
- setting route metrics 791
- summarizing routes 791
- timer values 784
- version 1 description 783
- version default on interfaces 784
- RIP routes, maximum 784
- RIPv1 783
- RIPv2 784
- root bridge 811, 951
- route maps
 - configuring match commands 139
 - configuring set commands 141
 - creating 137
 - creating multiple instances 137
 - default action 137
 - definition 136
 - deleting 137, 138
 - implementation 136
 - implicit deny 136
 - redistributing routes 141
 - tagging routes 142
- RSA 840

S

- Scalabilty
 - PVST+
 - Layer 2 746
- SCP 837, 838
- SCP/SSH server 838
- searching show commands 44
 - display 44
 - grep 44
- Secondary VLAN 736
- secondary VLAN 736
- Secure Shell (SSH) 837
- show accounting command 819
- show arp command 743
- show crypto 840
- show hardware commands (S60) 1073
- show interfaces command 478
- show interfaces switchport command 477
- show interfaces switchport Sample Output 858
- show ip protocols command 793, 795
- show ip rip database command 793, 795
- show ip route command 793, 795
- show ip ssh client-pub-keys 840

- show ip ssh command 838
- show ip ssh rsa-authentication 840
- show vlan command 743
- Spanning Tree group. *See* STG.
- Splitting QSFP ports 464
- SSH 837
 - connection 840
 - debug 839
 - display 838
 - host-keys 840
 - ssh command 838
- ssh-peer-rpm 840
- SSHv2 server 840
- standard IP ACL 110
- static route 486
- STG
 - changing parameters 812, 951
 - default 812, 951
 - port cost 812, 951
 - root bridge 811, 951
- STP
 - benefits 945
 - bridge priority 814, 955
 - default 812, 951
 - definition 945
 - disabling STP 808, 948
 - forward delay 812, 951
 - hello time 812, 951
 - interfaces 808, 948
 - max age 812, 951
 - port cost 812, 952
 - port ID 946
 - port priority 812, 951, 952
 - Portfast 813, 952
 - root bridge 814, 955
- switchport mode private-vlan command 738

T

- TACACS+ 833
 - authentication 835
 - authorization 835
 - deleting a server host 837
 - selecting TACACS+ as a login authentication method 834
 - servers and access classes 835
- tacacs-server host command 822
- Tag Control Information 998
- Tag Header 997
 - definition 997
 - Ethernet frame 998

- tagged interfaces
 - member of multiple VLANs 1000
- TCP Tiny and Overlapping Fragment Attack, Protection Against 837
- TDR (Time Domain Reflectometer) 463
- Telnet 836
- Telnet Daemon, Enabling and Disabling 843
- Time Domain Reflectometer (TDR) 463
- Time to Live (TTL) 623
- Trace list 844
- Trace lists
 - configuring a trace list 845
 - configuring filter without sequence number 847
 - configuring trace list for TCP 845
 - configuring trace list for UDP 846
- trunk port 736
- TTL 623

U

- user level
 - definition 823
- user name
 - configuring user name 824
- username command 826

V

- virtual IP addresses 1047
- Virtual LANs. *See* VLAN.
- Virtual Router Identifier. *See* VRID.
- Virtual Router Redundancy Protocol. *See* VRRP.
- virtual-ip
 - Important Things to Remember 443
- VLAN
 - isolated 736
 - primary 736
 - private
 - base 736
 - secondary
 - community 736
 - isolated 736
- VLAN configuration, automatic 397
- VLAN Protocol Identifier 998
- VLAN types 735
- VLAN types (private VLAN) 735
- VLANs 440, 995
 - adding a port channel 453
 - adding interface 997
 - assigning IP address 1002
 - benefits 995
 - configuring MTU values 473
 - defaults 996

- definition 995
- enabling tagging 1000
- FTP 69, 1002
- hybrid ports 1000
- IP routing 445, 997
- Layer 2 interfaces 999
- port-based 997
- removing a port channel 453
- removing tagged interface 997, 1000
- SNMP 1002
- tagged interfaces 998, 999
- TFTP 1002
- untagged interfaces 999
- viewing configured 999
- VLSM 483
- VLSM (Variable Length Subnet Masks) 784
- VLT
 - ports
 - orphan 1012
- VRRP 1043
 - advertisement interval 1052
 - benefits 1045
 - changing advertisement interval 1053
 - configuring priority 1050
 - configuring simple authentication 1051
 - definition 1043
 - disabling preempt 1052
 - MAC address 1043
 - monitoring interface 1054
 - simple authentication 1051
 - transmitting VRRP packets 1047
 - virtual IP addresses 1047
 - virtual router 1047
 - VRID 1043, 1047
- VTY lines
 - access class configuration 850
 - access classes and TACACS+ servers 835
 - assigning access classes by username 850
 - deny all, deny incoming subnet access-class application 851
 - deny10 ACLs, support for remote authentication and authorization 836
 - line authentication, support for 851
 - local authentication and authorization 850
 - local authentication and authorization, local database source of access class 850
 - radius authentication, support for 851
 - remote authentication and authorization 835
 - remote authentication and authorization, 10.0.0.0 subnets 836
 - remote authentication and local authorization 851

TACACS+ authentication, support for local
authorization 851

W

When to Use CAM Profiling 267

